

Free Downloads of Build Instructions,
Assembly Booklets & How To Guides

BuildInstructions.com

ACASTUS KNIGHT PORPHYRION

One of the most heavily armed and armoured of all Knight chassis in service, the Acastus Knight Porphyryon rivals in terms of size and power that of the Scout Titans of the Legio Titanicus. Armed with the Ironstorm or Helios missile pod and twin-linked magna-lascannon, it is truly a force to be reckoned with on any battlefield.

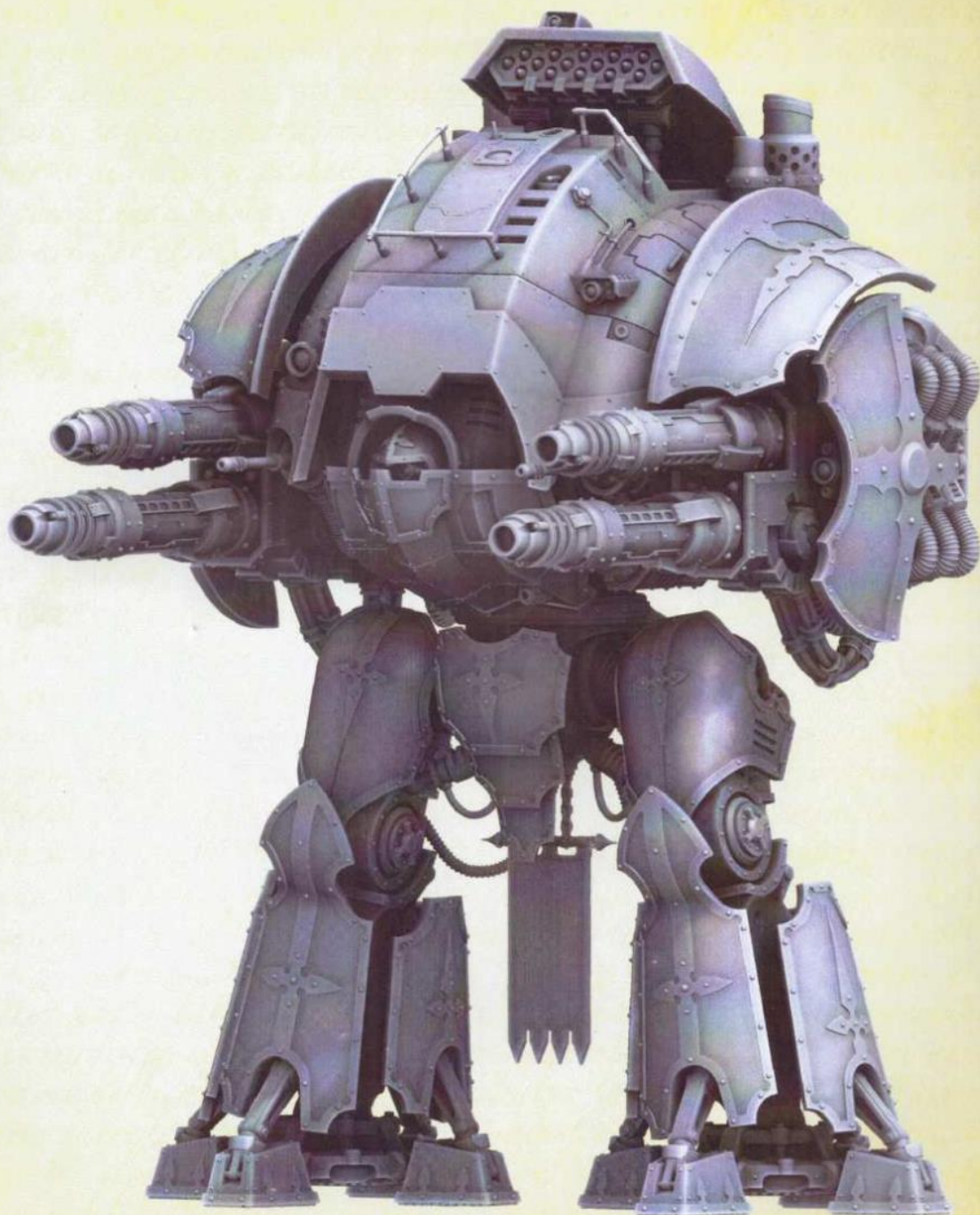

THIS IS NOT A TOY

Not suitable for children under 15 years of age.

WARNING: Resin dust can be harmful if inhaled. Always wear a dust mask or respirator when sanding or sawing resin parts.

www.forgeworld.co.uk



993201080189

Components



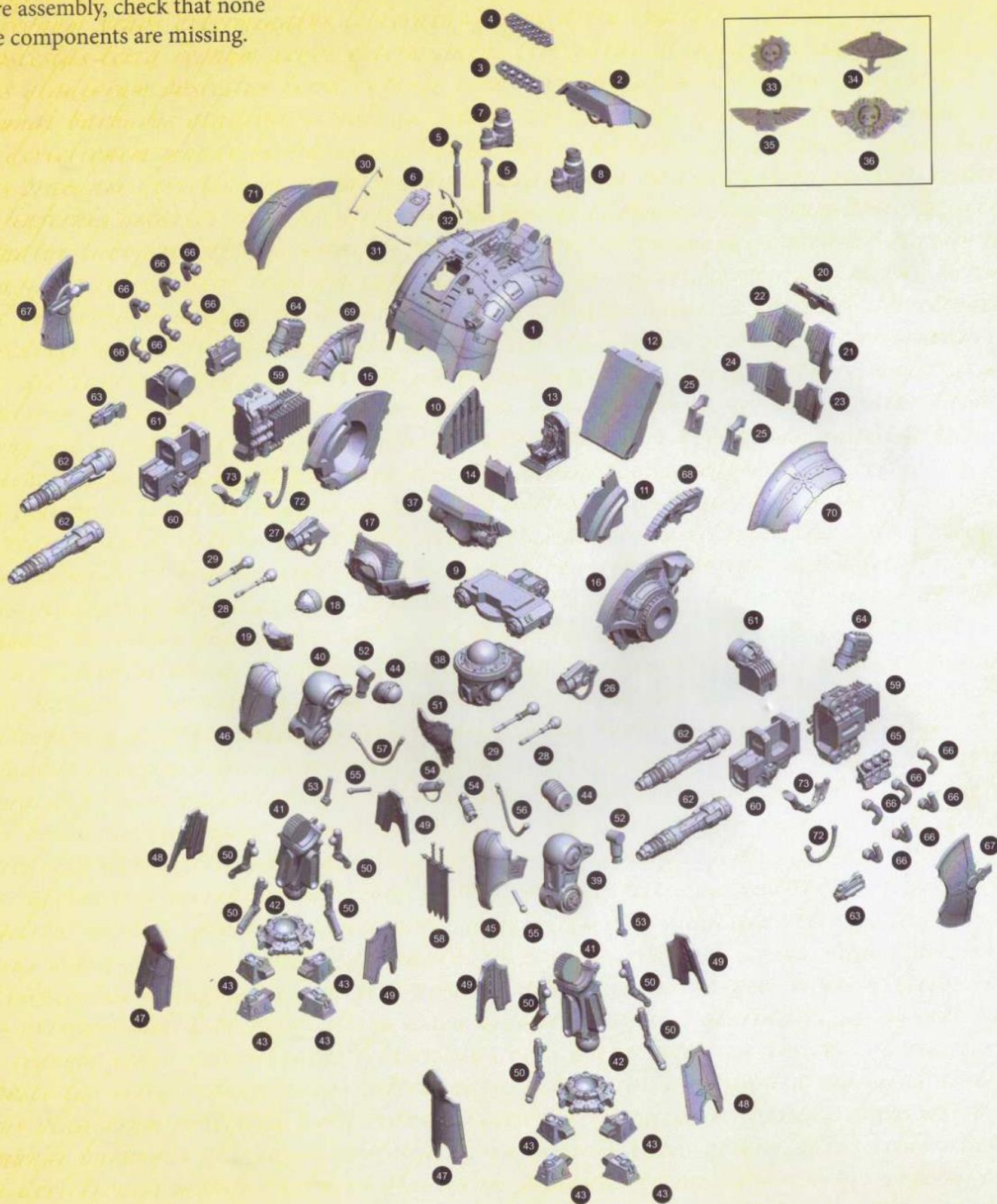





Before assembly, check that none of the components are missing.



If you need to contact the Forge World Customer Service team regarding this model, you can get in touch via email - foreworld@gwplc.com - or call:
0115 900 4995 within the UK
011 44 115 900 4995 from the USA and Canada
0011 44 115 900 4995 from Australia
00 44 115 900 4995 from Europe and the rest of the world.

- | | | |
|----------------------------|------------------------------|--------------------------------|
| 1. Carapace | 26. Left Shoulder Gun Mount | 51. Waist Plate |
| 2. Launcher | 27. Right Shoulder Gun Mount | 52. Thigh Piston Cylinder x2 |
| 3. Helios Missiles | 28. Secondary Autocannon x2 | 53. Thigh Piston Rod x2 |
| 4. Ironstorm Missiles | 29. Secondary Lascannon x2 | 54. Hip Piston Cylinder x2 |
| 5. Launcher Piston x2 | 30. Right Handrail | 55. Hip Piston Rod x2 |
| 6. Hatch | 31. Front Handrail | 56. Right Leg Cable |
| 7. Right Exhaust | 32. Rear Handrail | 57. Left Leg Cable |
| 8. Left Exhaust | 33. Mechanicum Symbol | 58. Pennant |
| 9. Lower Torso | 34. Eye of Horus Symbol | 59. Heat Sink Power Core x2 |
| 10. Right Interior Wall | 35. Imperial Eagle Symbol | 60. Arm Weapon Main Body x2 |
| 11. Left Interior Wall | 36. Imperial Knight Symbol | 61. Arm Mount x2 |
| 12. Torso Rear | 37. Torso Front | 62. Barrel x4 |
| 13. Command Throne | 38. Waist | 63. Sight x2 |
| 14. Interior Front | 39. Left Thigh | 64. Power Module x2 |
| 15. Torso Right | 40. Right Thigh | 65. Manifold x2 |
| 16. Torso Left | 41. Lower Leg x2 | 66. Manifold Pipe x12 |
| 17. Gorget Plate | 42. Foot x2 | 67. Side Shield x2 |
| 18. Head | 43. Toe x8 | 68. Left Shoulder Plate Mount |
| 19. Face Guard | 44. Hip x2 | 69. Right Shoulder Plate Mount |
| 20. Upper Rear Plate | 45. Left Thigh Plate | 70. Left Shoulder Plate |
| 21. Left Upper Rear Plate | 46. Right Thigh Plate | 71. Right Shoulder Plate |
| 22. Right Upper Rear Plate | 47. Lower Leg Plate Front x2 | 72. Power Cable x2 |
| 23. Left Lower Rear Plate | 48. Outer Leg Plate x2 | 73. Secondary Cables x2 |
| 24. Right Lower Rear Plate | 49. Leg Plate x4 | |
| 25. Rear Plate Mount x2 | 50. Lower Leg Piston x8 | |

Assembly Legend

Parts for Assembly	
Note	
Glue Contact Area	
Shim for Removal	
Reverse Angle	
Do Not Glue	
Insert	
Hidden Component	
Component Highlight	

Preparing the Model for Assembly

Before assembling the model, wash each part thoroughly with an abrasive brush, such as a toothbrush, to remove any model release agent that may still be on the surface of the parts. Then, remove any excess resin such as mould lines, casting gates, vents and shims. For a more detailed guide to working with resin models, go to the Downloads section of the Forge World website.

This kit contains all the pieces required to construct the Acastus Knight Porphyrior. To glue the resin pieces together, use Citadel Super Glue.

NOTE: We have cast this kit using advanced techniques and the best quality resin, but due to the nature of the casting process, your model may contain small air bubbles. These can easily be filled with model filler or super glue. Any slight warpage of thin parts can be corrected by immersing the part in hot water for about 1 minute, then bending it back into shape.

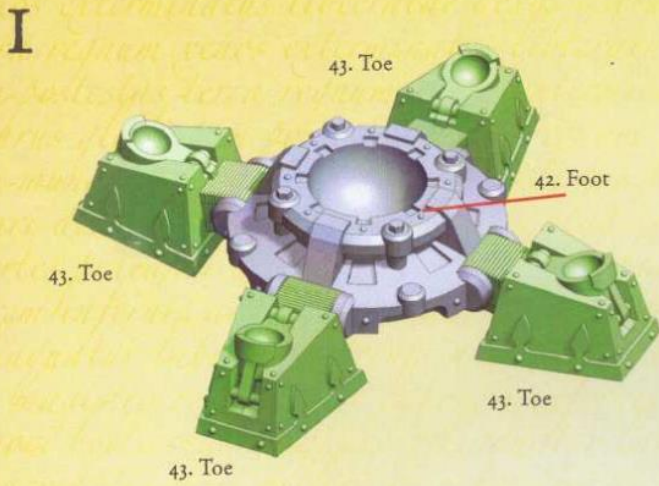

! Repeat this stage for both feet.

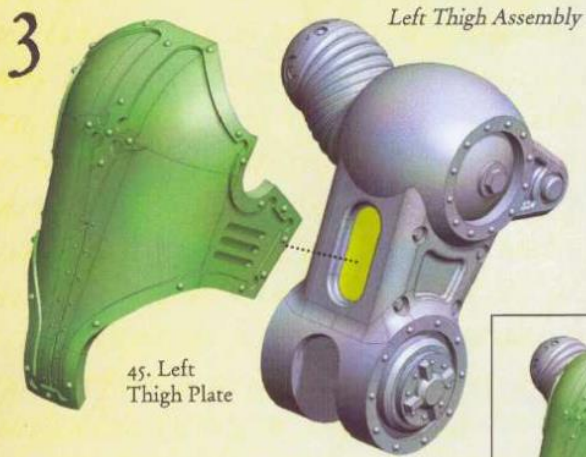
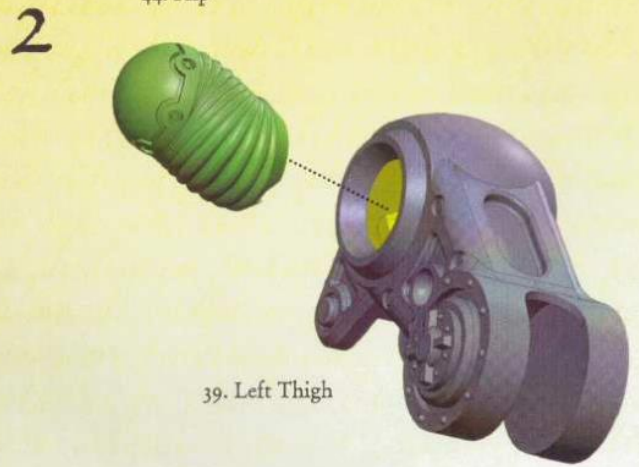

! Repeat stages 2 & 3 for parts 40. Right Thigh, 44. Hip and 46. Right Thigh Plate.

! It is easier to paint the model before attaching the armour plates.

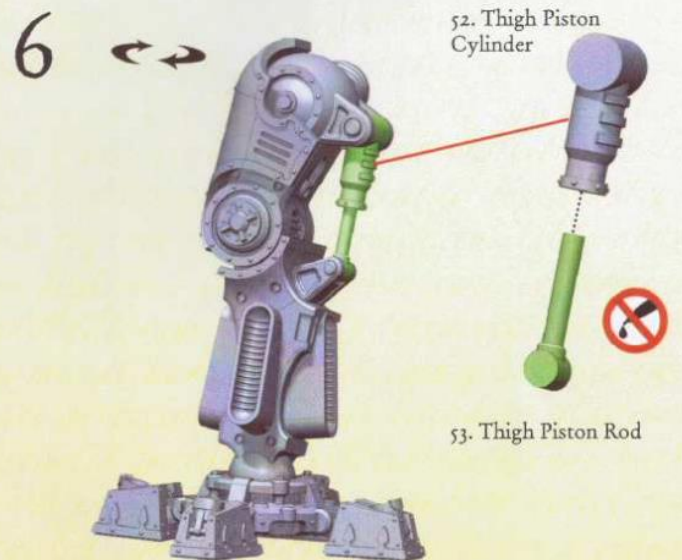
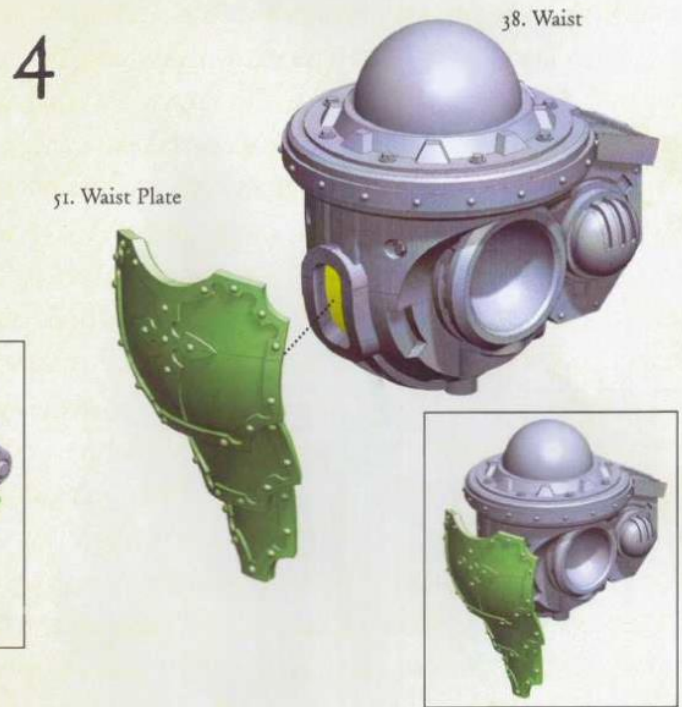

7



50. Lower Leg Pistons

8

47. Lower Leg Plate Front



9



48. Outer Leg Plate

 Repeat stages 5 - 9 for the right leg.

49. Leg Plates

10

Waist Assembly

Right Leg Assembly

Left Leg Assembly

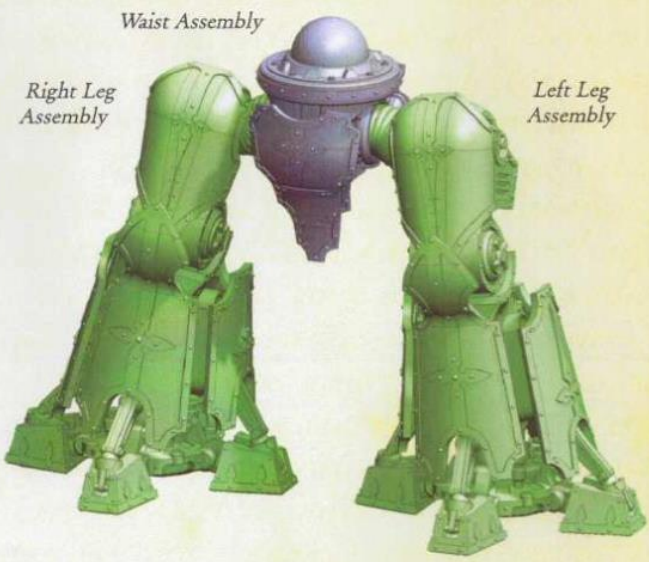

11

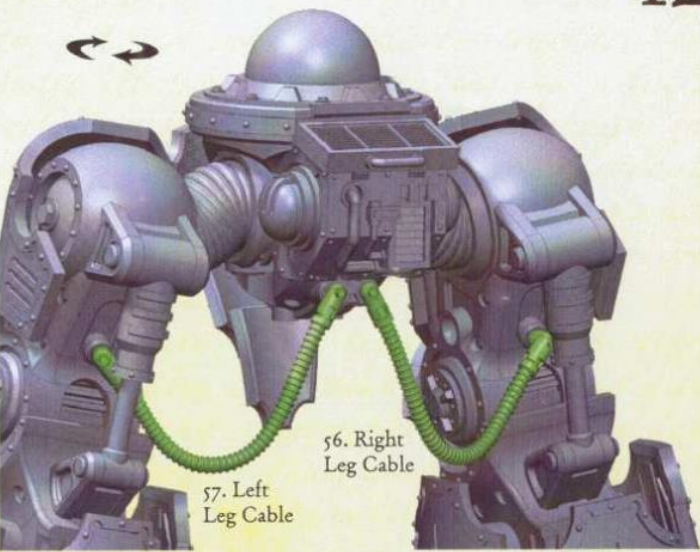

57. Left Leg Cable

56. Right Leg Cable

12

54. Hip Piston Cylinder

55. Hip Piston Rod

Hip Piston Assemblies

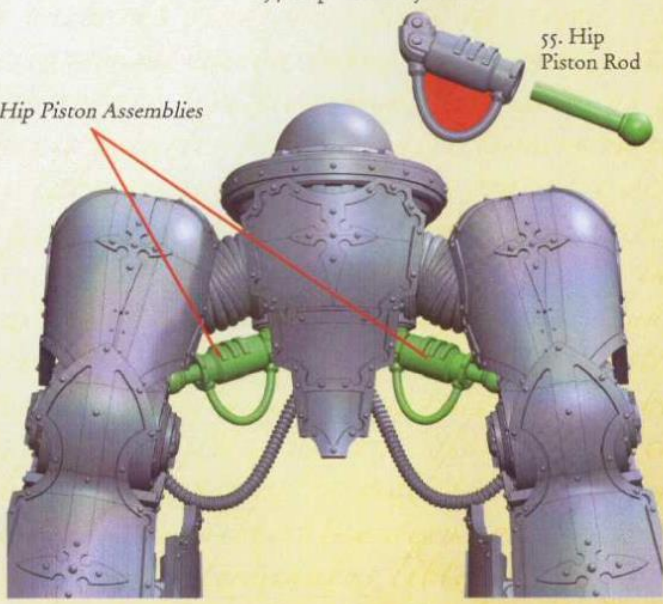

I3

10. Right Interior Wall

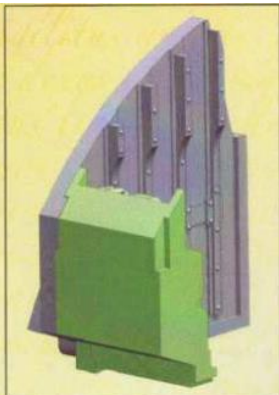

I4

13. Command Throne

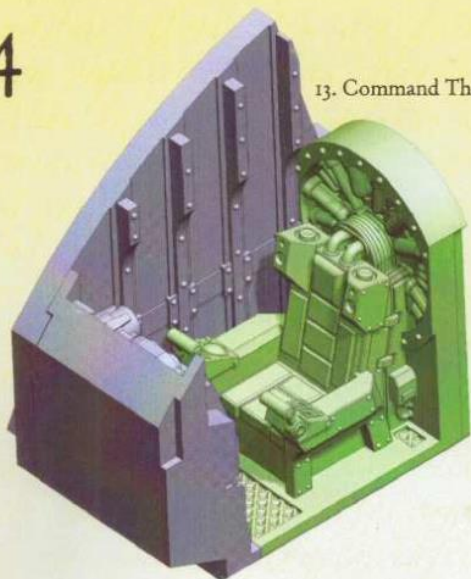

14. Interior Front

I5

11. Left Interior Wall



I6

15. Torso Right

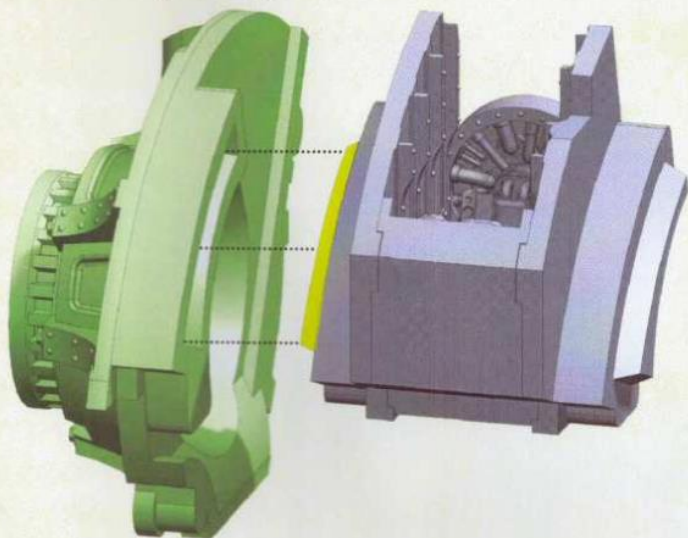

I7

I8

16. Torso Left

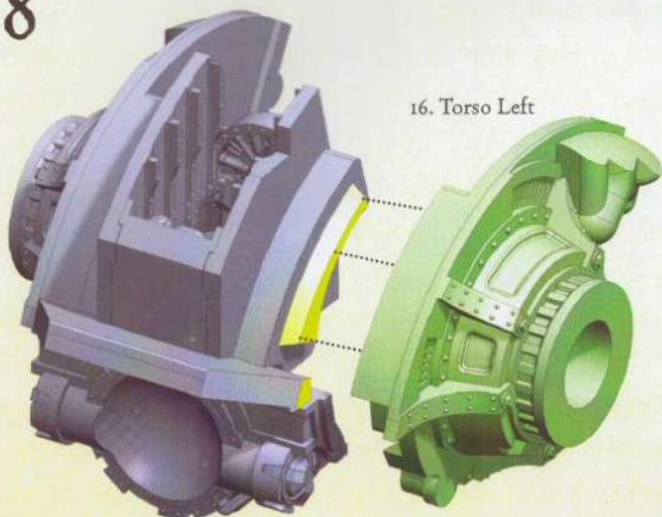
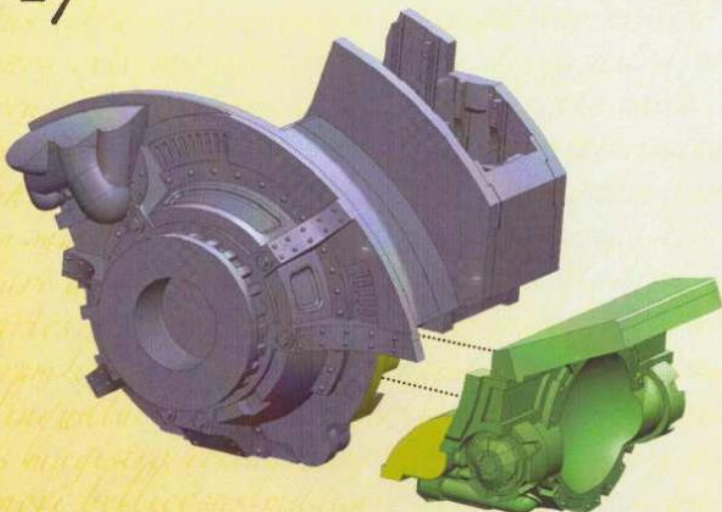

37. Torso Front

19

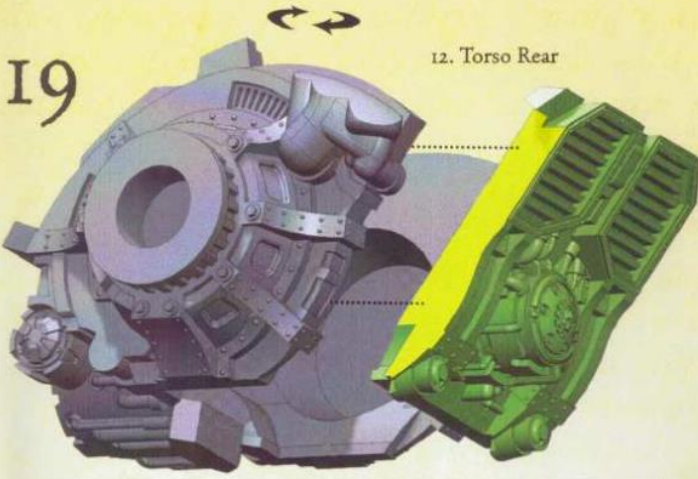

12. Torso Rear

20

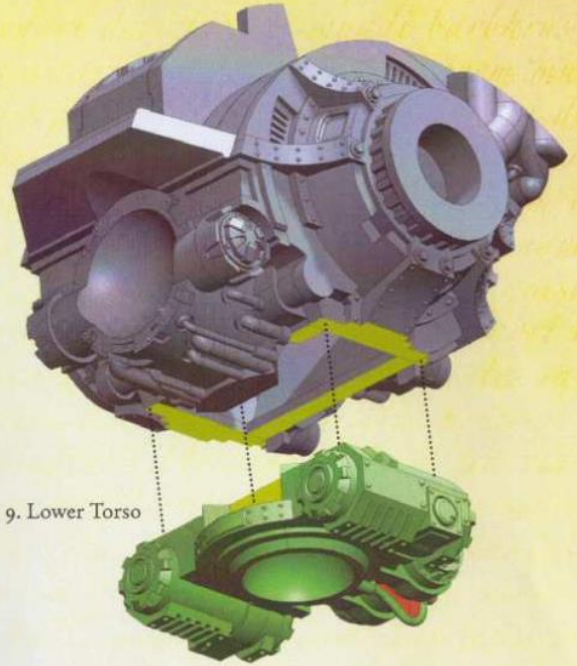

9. Lower Torso

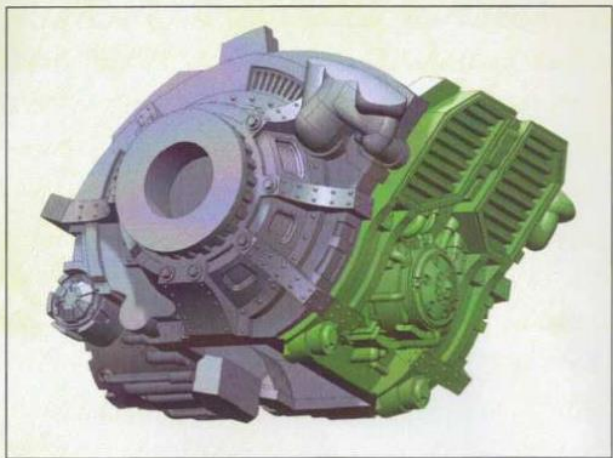

21

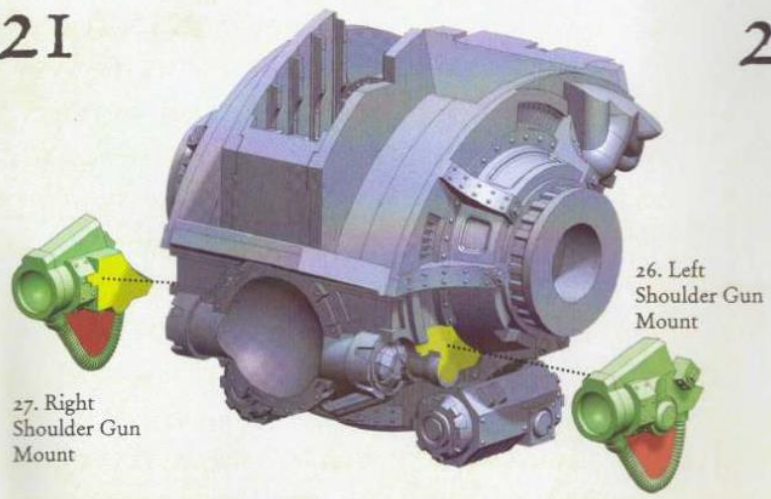

26. Left Shoulder Gun Mount

27. Right Shoulder Gun Mount

22



1. Carapace

23

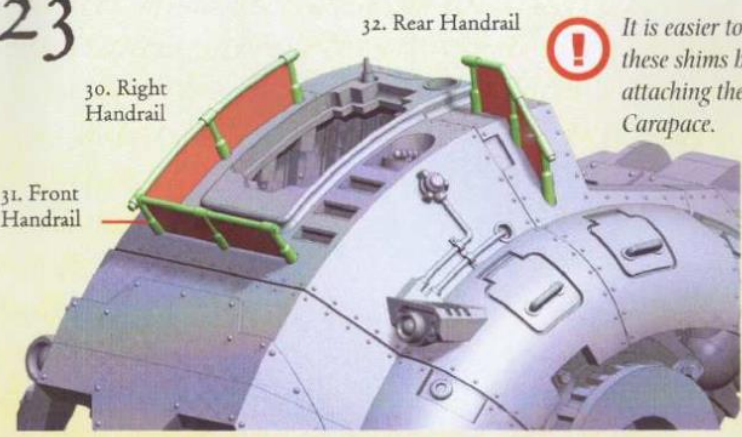

32. Rear Handrail

30. Right Handrail

31. Front Handrail



It is easier to remove these shims before attaching the rails to the Carapace.

24

7. Right Exhaust

8. Left Exhaust.

6. Hatch

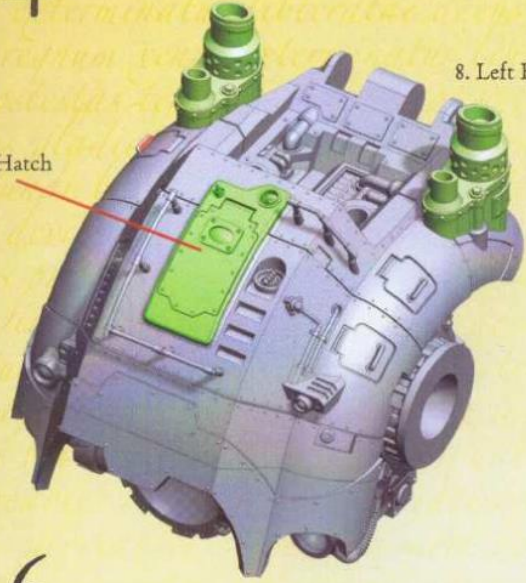

25

3. Helios Missiles

4. Ironstorm Missiles

2. Launcher

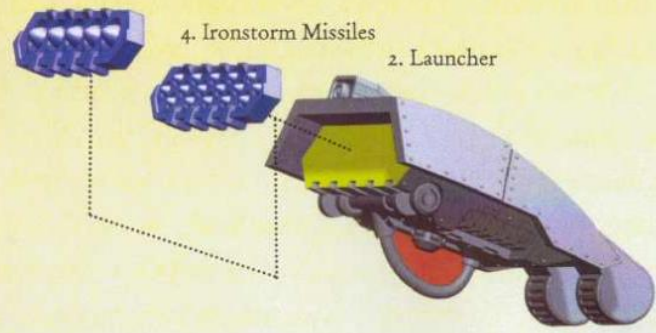

26

5. Launcher Pistons



27

Missile Launcher Assembly



 The Missile Launcher can be assembled open or closed.

28

18. Head



29

19. Face Guard

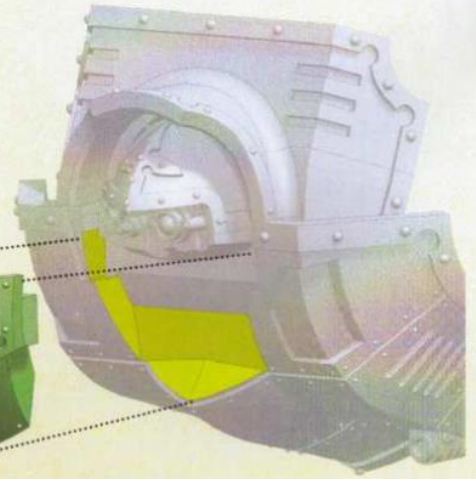

 The Head can be held in place by part 19. Face Guard, allowing you to turn it as needed. It is easier to paint the head before attaching it to the body.

30

Head Assembly

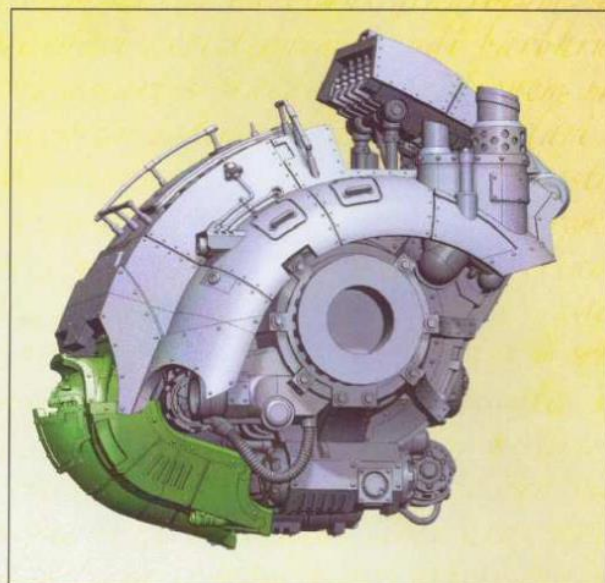
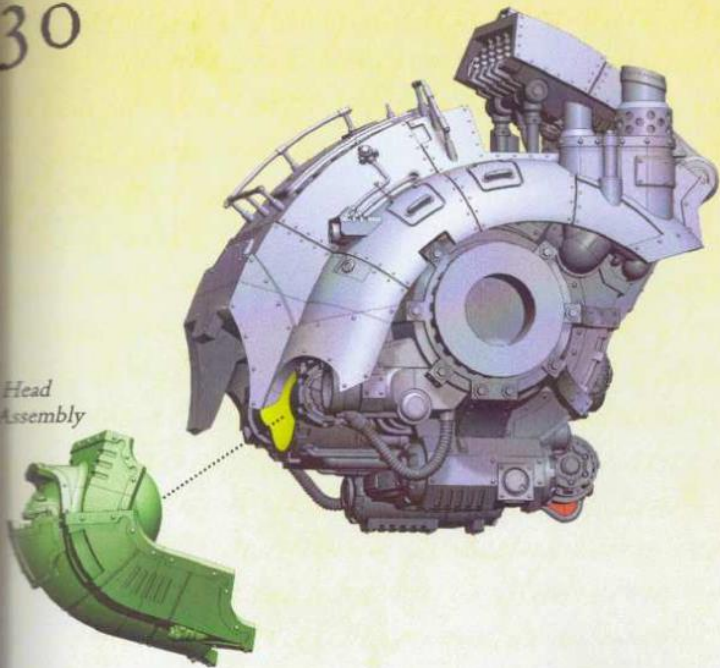

31

28. Secondary Autocannon
29. Secondary Lascannon

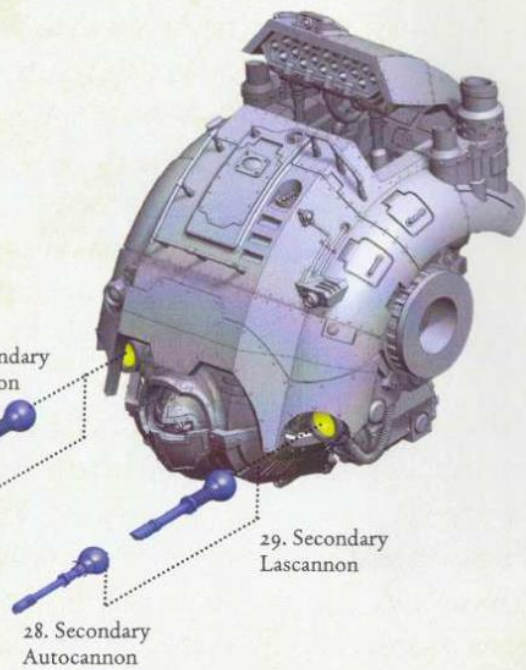

32

20. Upper Rear Plate

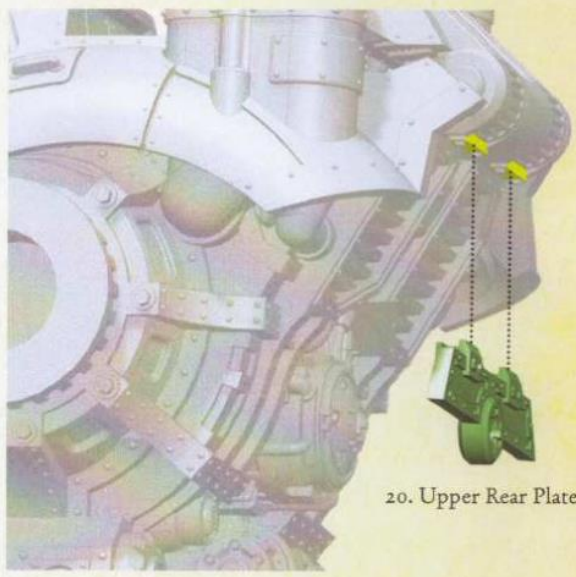

33

22. Right Upper Rear Plate
21. Left Upper Rear Plate

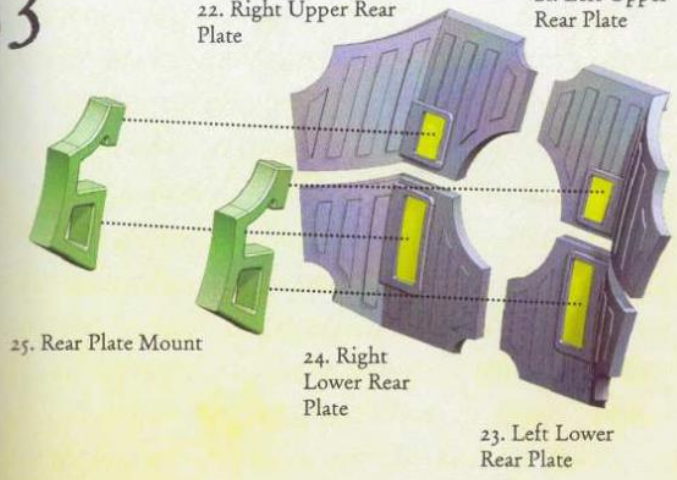

34

Left Rear Armour Plate Assembly

Right Rear Armour Plate Assembly

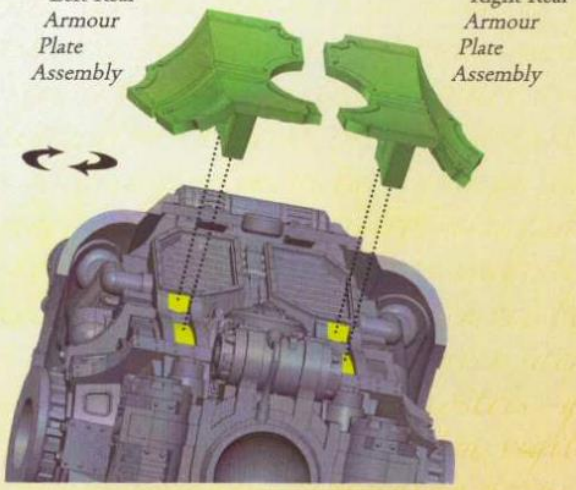

35

Torso Assembly



Legs Assembly

36

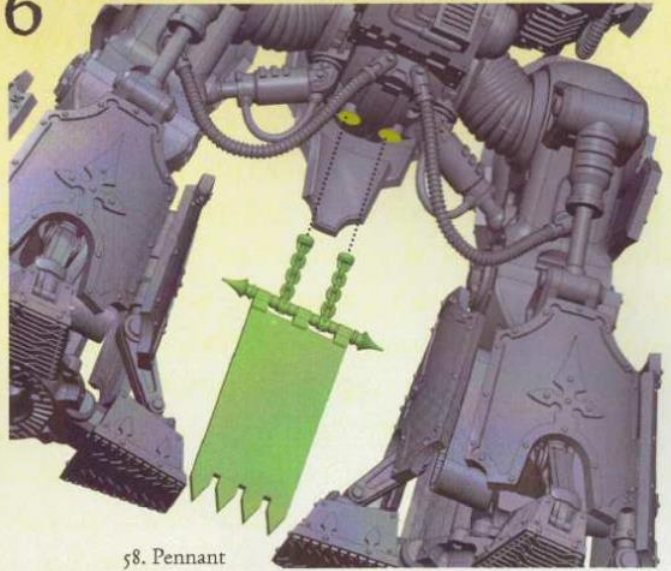

58. Pennant

37

61. Arm Mount



60. Arm Weapon Main Body

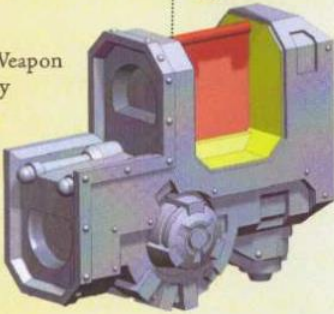

The Arm Mount can be positioned for either the left or right arms. In this example we will build the left arm.

38

68. Left Shoulder Plate Mount



39

62. Barrel x2

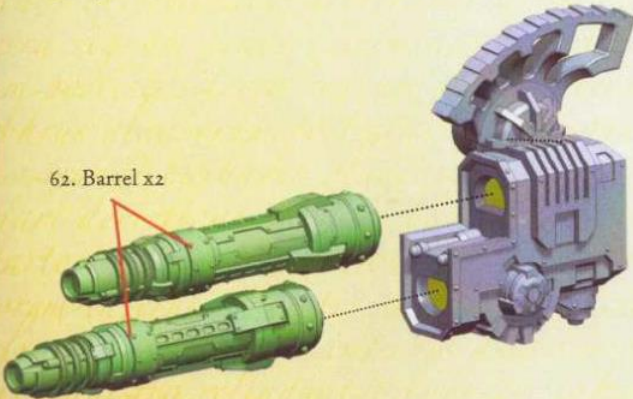

40

59. Heat Sink Power Core

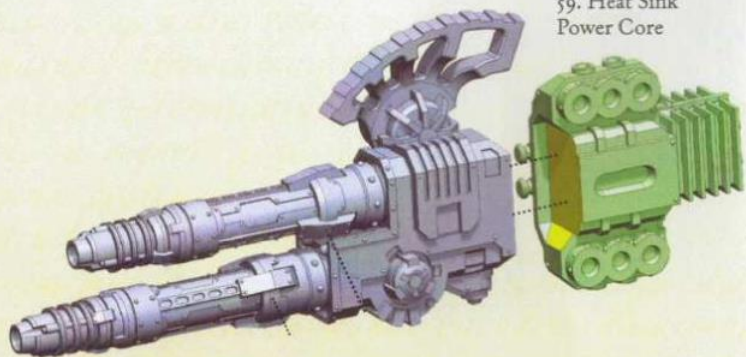

41



63. Sight

42

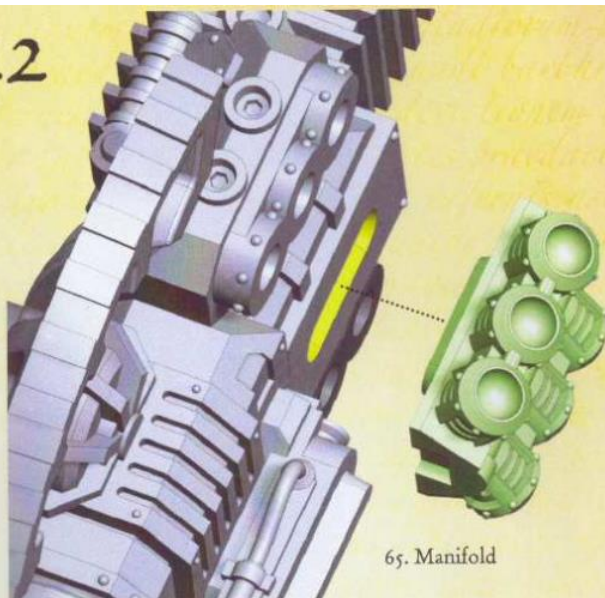

65. Manifold

43

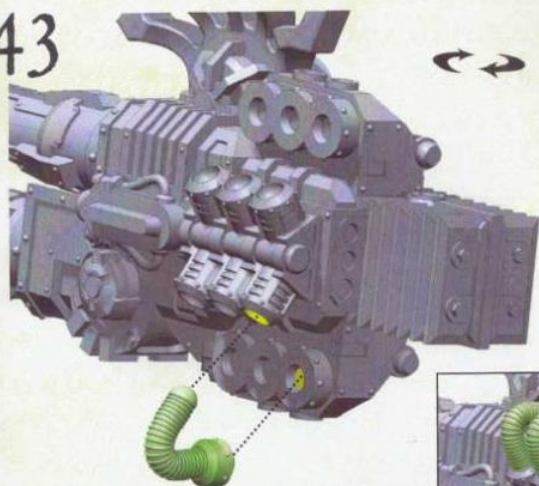

66. Manifold Pipe

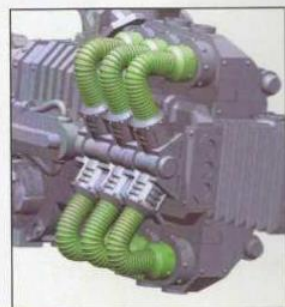

44

64. Power Module

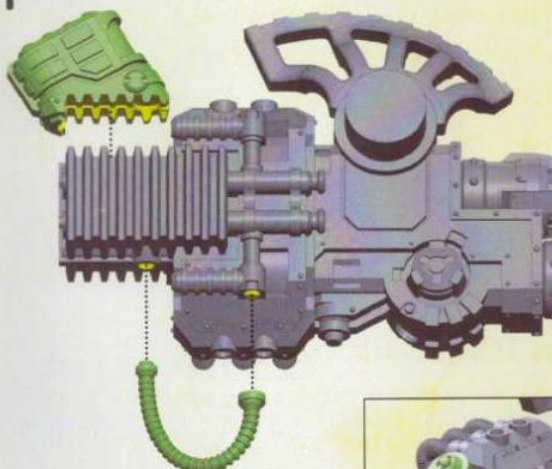

72. Power Cable



45

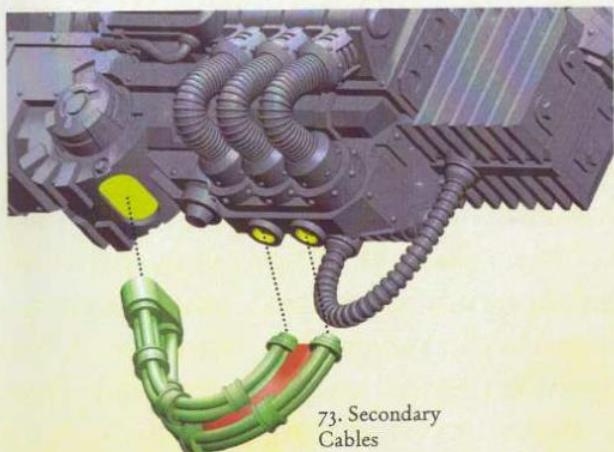

73. Secondary Cables

46



67. Side Shield

47

70. Left Shoulder Plate



Make sure the Shoulder Plate is aligned as shown.

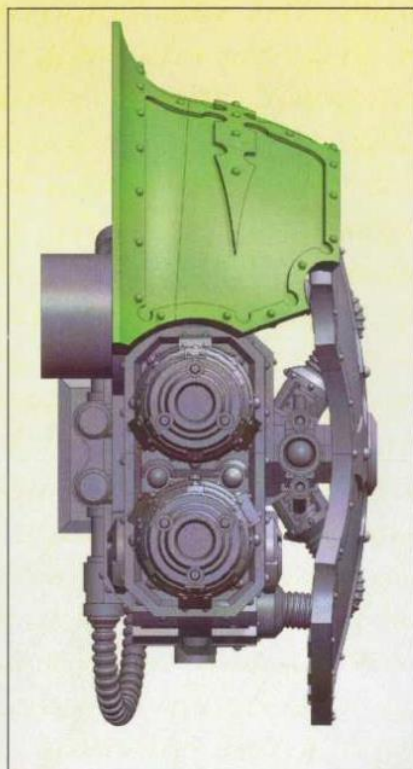

Repeat stages 37 - 47 for the Right Weapon Arm using parts 69, Right Shoulder Mount and 71, Right Shoulder Plate

48

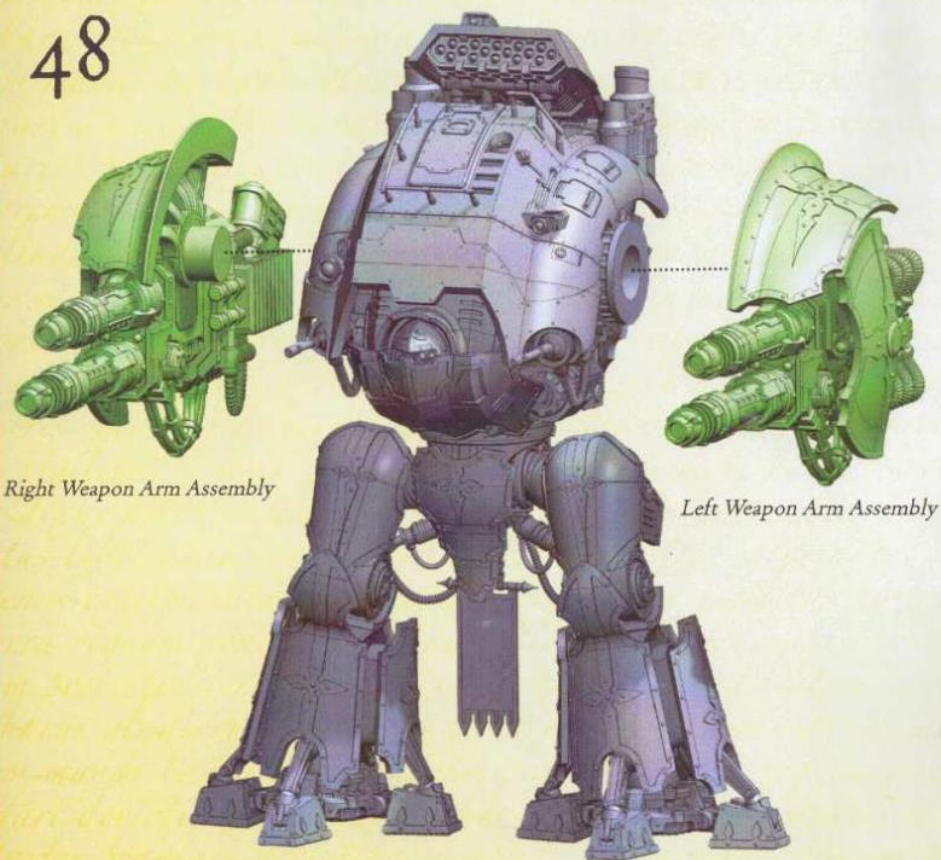

Right Weapon Arm Assembly

Left Weapon Arm Assembly

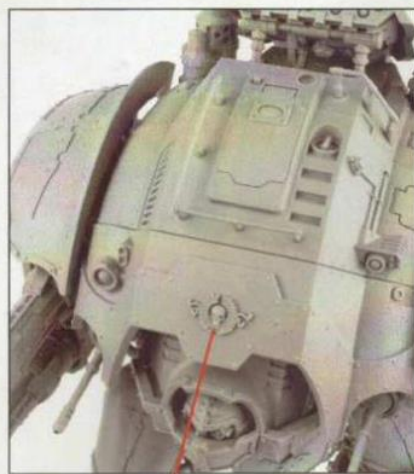

36. Imperial Knight Symbol



If desired, you can place one of the four symbols appropriate for your Acastus Knight Porphyron.

© Copyright Games Workshop Limited 2016. All rights reserved.

www.forgeworld.co.uk



games-workshop.com



993201080189

forge World®

forgeworld.co.uk