

Free Downloads of Build Instructions,  
Assembly Booklets & How To Guides

**BuildInstructions.com**

# ACASTUS

## KNIGHT ASTERIUS

*Of the gigantic Acastus pattern Knights, some of the largest such war machines still known to exist, the Asterius is among the most rare. Like its more common cousin, the Porphyron, it boasts an armoured hide near impervious to weapons fire, striding across the battlefield like an angry giant beset by insects, and also wields a pair of ancient twin-linked conversion beam cannon. These weapons are irreplaceable relics of a lost technology, each capable of sundering the walls of fortresses and laying low powerful foes in a single blast.*

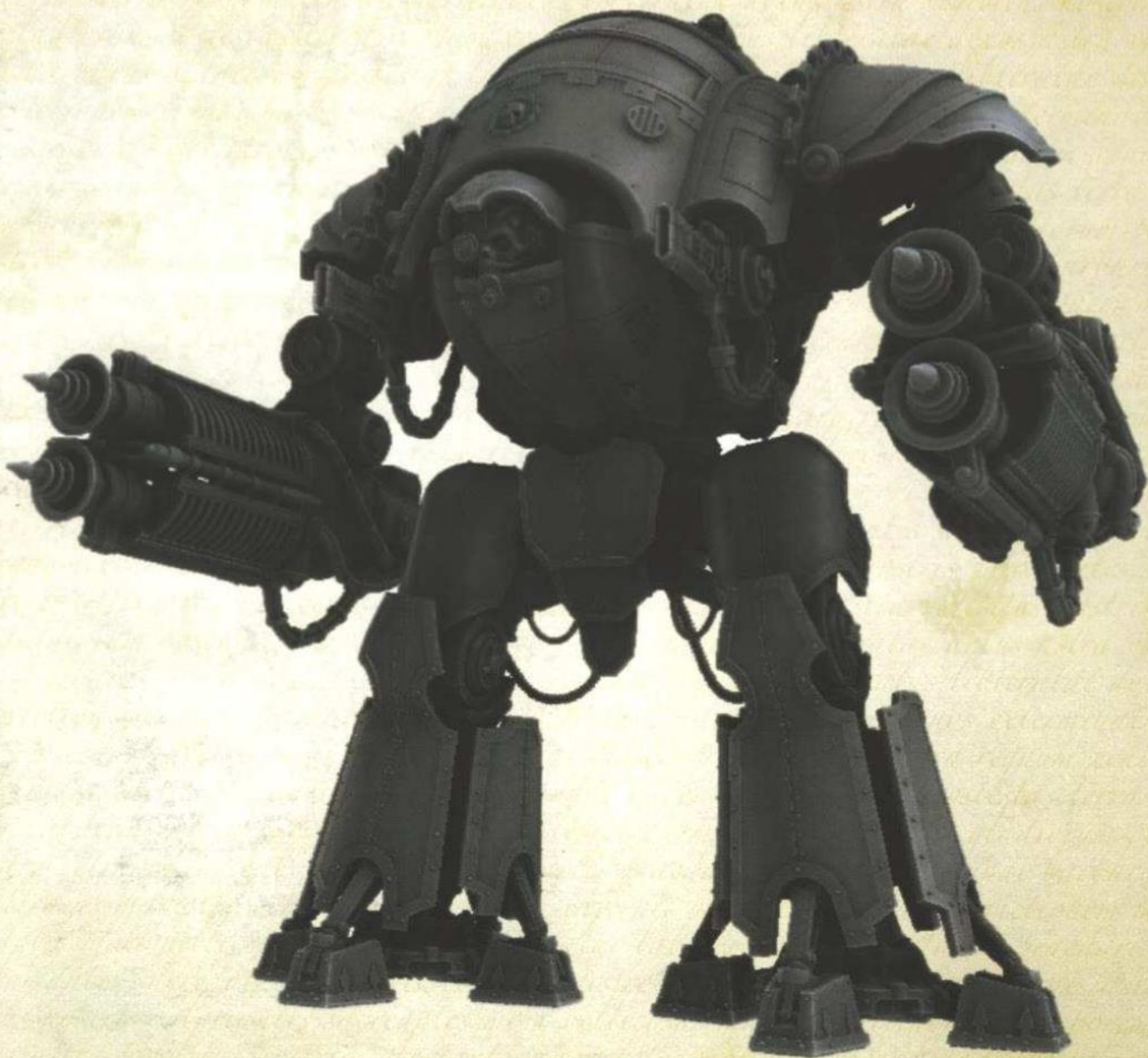

**THIS IS NOT A TOY**

Not suitable for children under 15 years of age.

**WARNING:** Resin dust can be harmful if inhaled. Always wear a dust mask or respirator when sanding or sawing resin parts.

[www.forgeworld.co.uk](http://www.forgeworld.co.uk)



993201080547R02

# Components

Before assembly, check that none of the components are missing.



## Assembly Legend

Parts for Assembly	
Note	
Glue Contact Area	
Shim for Removal	
Reverse Angle	
Do Not Glue	
Insert	
Hidden Component	
Component Highlight	

## Preparing the Model for Assembly

Before assembling the model, wash each part thoroughly with an abrasive brush, such as a toothbrush, to remove any model release agent that may still be on the surface of the parts. Then, remove any excess resin such as mould lines, casting gates, vents and shims. For a more detailed guide to working with resin models, go to the Downloads section of the Forge World website.

This kit contains all the pieces required to construct the Acastus Knight Asterius. To glue the resin pieces together, use Citadel Super Glue.

**NOTE:** We have cast this kit using advanced techniques and the best quality resin, but due to the nature of the casting process, your model may contain small air bubbles. These can easily be filled with model filler or super glue. Any slight warpage of thin parts can be corrected by immersing the part in hot water for about 1 minute, then bending it back into shape.

- |   |   |   |
|---|---|---|
| 1. Waist  | 35. Lower Conversion Beam<br>Cannon Coil Frame x2 | 63. Left Secondary Weapon<br>Power Cable                |
| 2. Gorget Plate                                   | 36. Conversion Beam Cannon<br>Support Frame x2    | 64. Linkage Pin Cap x2                                  |
| 3. Torso Right                                    | 37. Interior Front                                | 65. Conversion Beam<br>Cannon Emitter x4                |
| 4. Torso Left                                     | 38. Command Throne                                | 66. Conversion Beam Cannon<br>Energy Collection Dish x4 |
| 5. Carapace                                       | 39. Conversion Beam Cannon<br>Cooling Cable 1 x2  | 67. Secondary Weapon<br>Linkage Pin x2                  |
| 6. Lower Torso                                    | 40. Conversion Beam Cannon<br>Cooling Cable 2 x2  | 68. Thigh Piston Rod x2                                 |
| 7. Torso Front                                    | 41. Left Shoulder Armature                        | 69. Thigh Piston Cylinder x2                            |
| 8. Left Thigh                                     | 42. Right Shoulder Armature                       | 70. Rear Carapace Frame x2                              |
| 9. Right Thigh                                    | 43. Conversion Beam Cannon<br>Cooling Cable 3 x2  | 71. Lower Leg Piston Side x4                            |
| 10. Lower Leg x2                                  | 44. Conversion Beam Cannon<br>Cooling Cable 4 x2  | 72. Lower Leg Piston Front x2                           |
| 11. Conversion Beam<br>Cannon x2                  | 45. Rear Right/Front Left<br>Weapon Mount         | 73. Lower Leg Piston Rear x2                            |
| 12. Torso Rear                                    | 46. Rear Left/Front Right<br>Weapon Mount         | 74. Conversion Beam<br>Cannon Coil x4                   |
| 13. Right Thigh Plate                             | 47. Conversion Beam Cannon<br>Power Cable x2      | 75. Hip x2  |
| 14. Left Thigh Plate                              | 48. Right Leg Cable                               | 76. Hip Piston Cylinder x2                              |
| 15. Right Exhaust                                 | 49. Left Leg Cable                                | 77. Lower Karacnos<br>Mortar Rack                       |
| 16. Left Exhaust                                  | 50. Right Karacnos Mortar Pipe                    | 78. Mid Karacnos Mortar Rack                            |
| 17. Head  | 51. Left Karacnos Mortar Pipe                     | 79. Upper Karacnos<br>Mortar Rack                       |
| 18. Left Shoulder Frame                           | 52. Weapon Linkage Pin x2                         | 80. Head Cowl   |
| 19. Right Shoulder Frame                          | 53. Volkite Linkage Pin x2                        | 81. Arm x2  |
| 20. Under Carapace Support                        | 54. Arm Mount x2                                  | 82. Conversion Beamer<br>Shield 1 x4                    |
| 21. Karacnos Mortar<br>Housing Side               | 55. Primary Weapon<br>Linkage Pin x4              | 83. Conversion Beamer<br>Shield 2 x4                    |
| 22. Left Interior Wall                            | 56. Hip Piston Rod x2                             | 84. Toe x8  |
| 23. Right Interior Wall                           | 57. Linkage Prop x4                               | 85. Primary Weapon<br>Pivot Mount x2                    |
| 24. Right Rear Plate Array                        | 58. Pivot Pin x2                                  | 86. Right Volkite Culverin                              |
| 25. Left Rear Plate Array                         | 59. Carapace Hose                                 | 87. Left Volkite Culverin                               |
| 26. Karacnos Mortar Housing                       | 60. Left Hood Hinge                               | 88. Left Shoulder Plate                                 |
| 27. Waist Plate                                   | 61. Right Hood Hinge                              | 89. Right Shoulder Plate                                |
| 28. Karacnos Mortar Cowl                          | 62. Right Secondary Weapon<br>Power Cable         |   |
| 29. Side Leg Plate x4                             |   |   |
| 30. Rear Leg Plate x2                             |   |   |
| 31. Foot x2                                       |   |   |
| 32. Lower Leg Plate Front x2                      |   |   |
| 33. Upper Conversion Beam<br>Cannon Coil Frame x2 |   |   |
| 34. Conversion Beam Cannon<br>Power Regulator x2  |   |   |



If you need to contact the Forge World Customer Service team regarding this model, you can get in touch via email – [forgeworld@gwplc.com](mailto:forgeworld@gwplc.com) – or call:

0115 900 4995 within the UK

011 44 115 900 4995 from the USA and Canada

0011 44 115 900 4995 from Australia

00 44 115 900 4995 from Europe and the rest of the world.

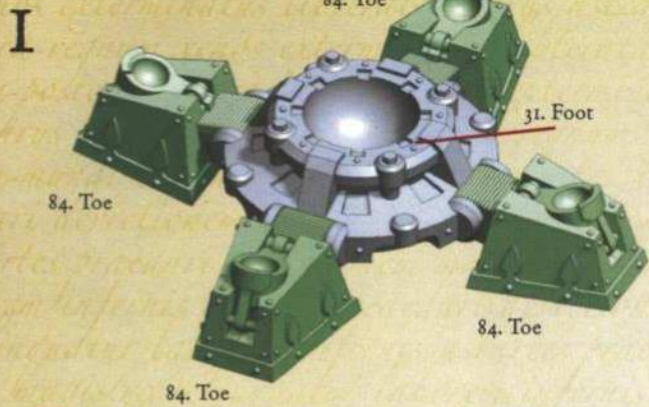

**!** Repeat this stage for both Feet.

**!** When attaching the Foot Assembly to the Lower Leg, make sure that the sockets for the Lower Leg Pistons line up with the groove in the Lower Leg.

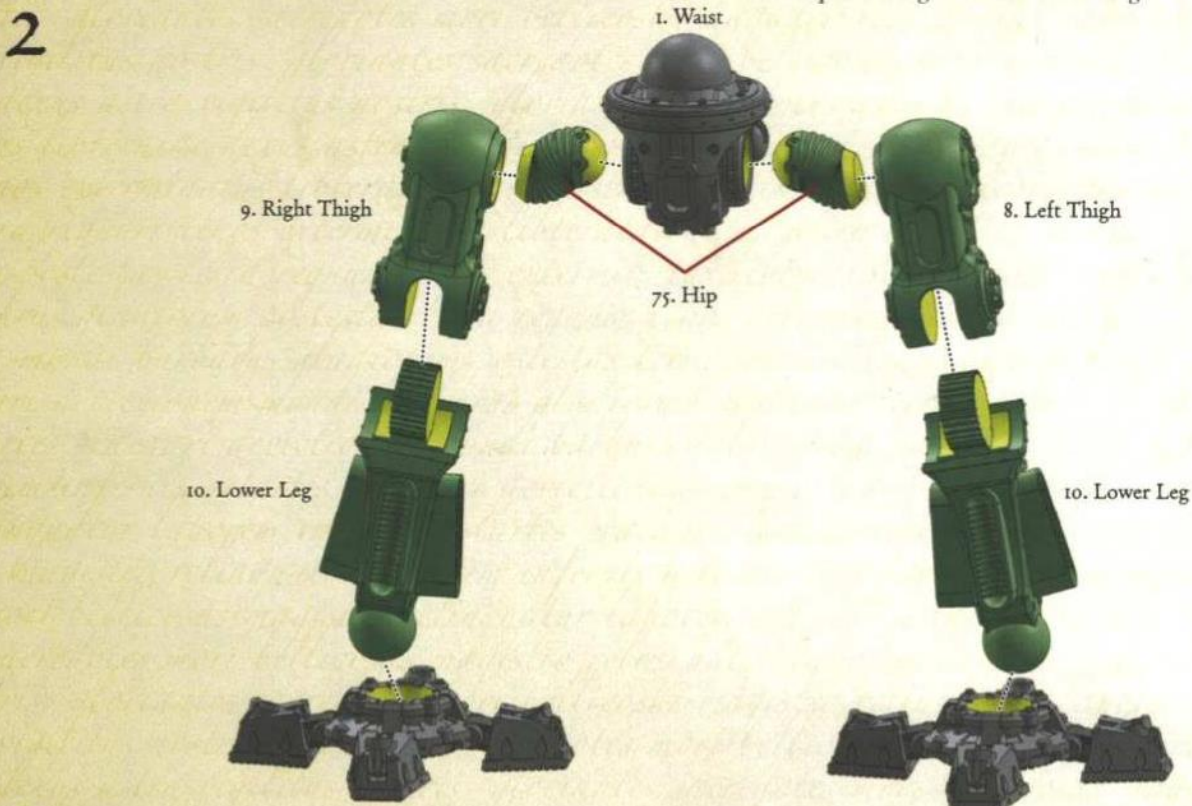

**!** Dependent on the position of the legs, part 56. Hip Piston Rod and 68. Thigh Piston Rod may need to be trimmed to fit.



**!** Repeat this stage with part 48. Right Leg Cable. If the leg is in a walking pose, you may need to heat the Leg Cables and bend them into position.

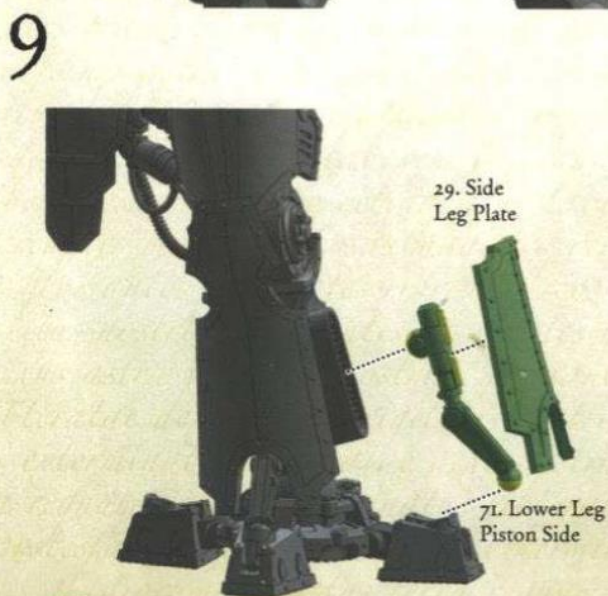
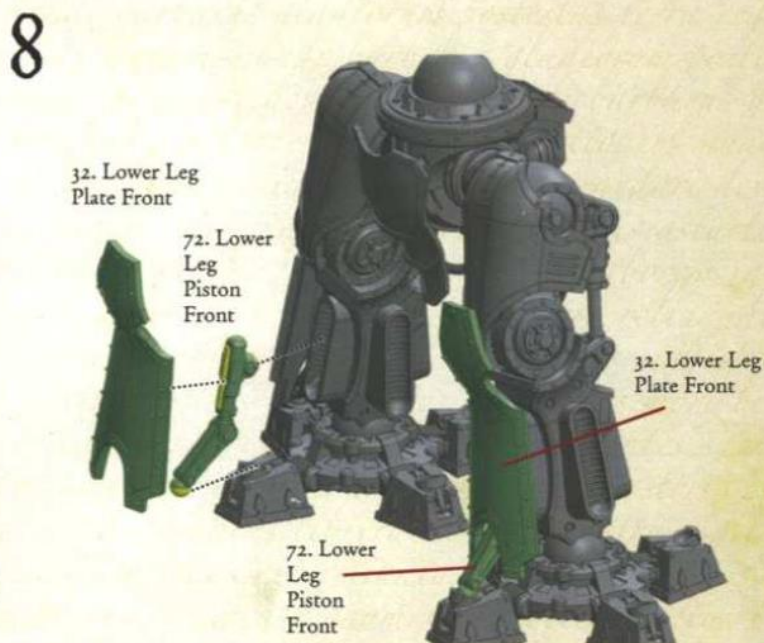

**!** Repeat this stage with Right Leg.



I1

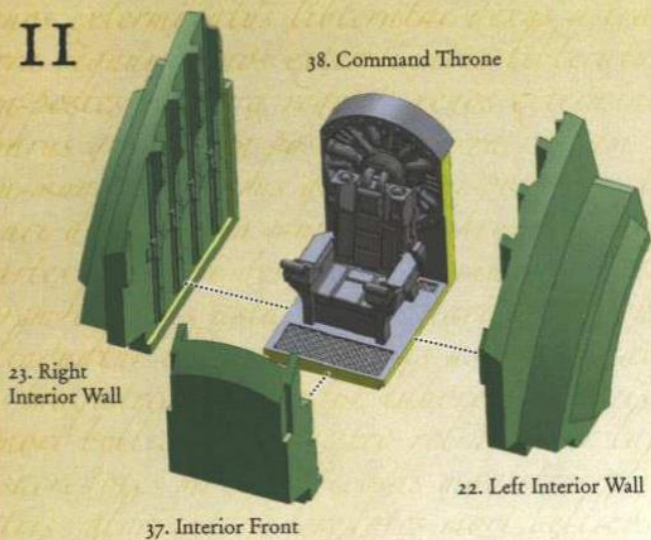

I2

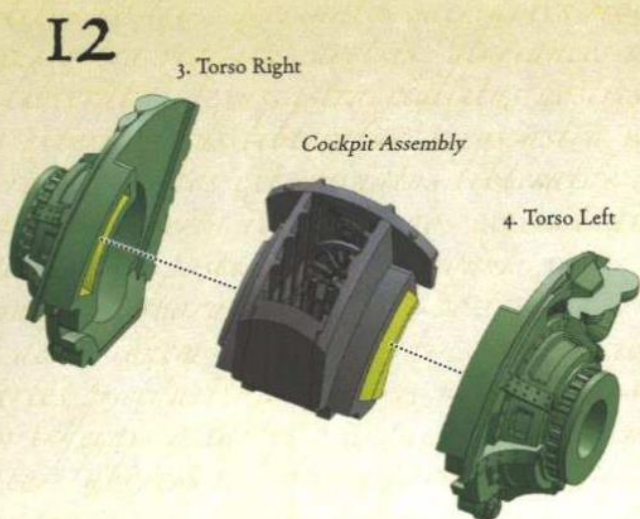

I3

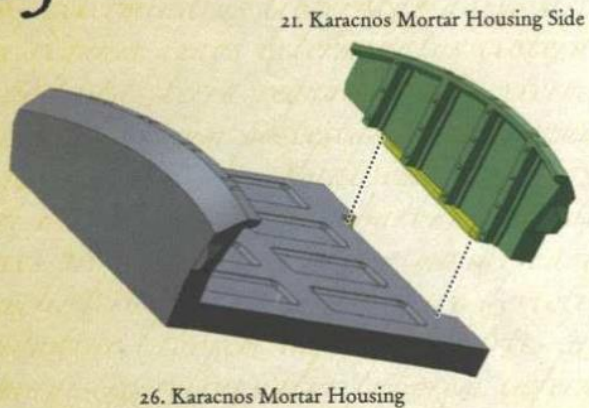

I4

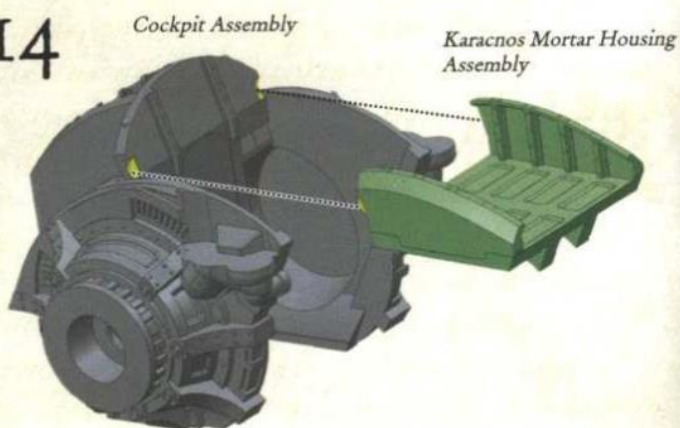

I5

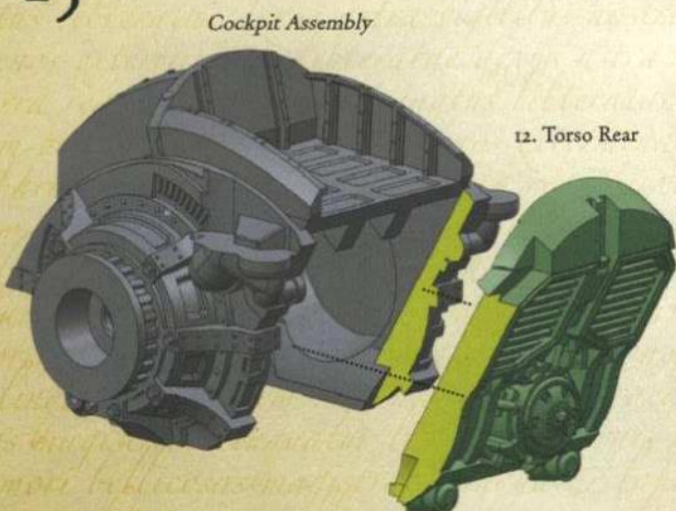

I6

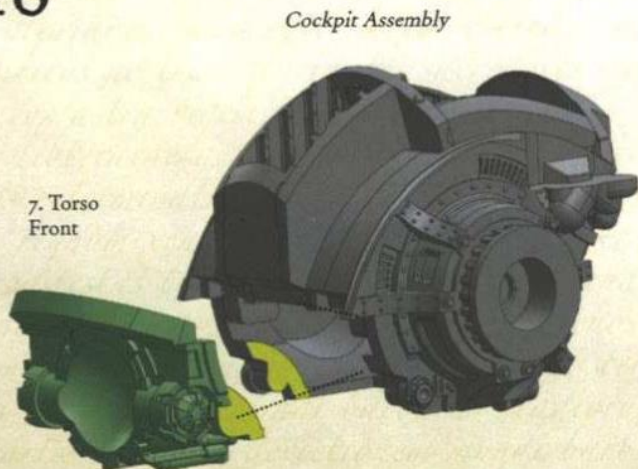

Cockpit Assembly

17



6. Lower Torso

18

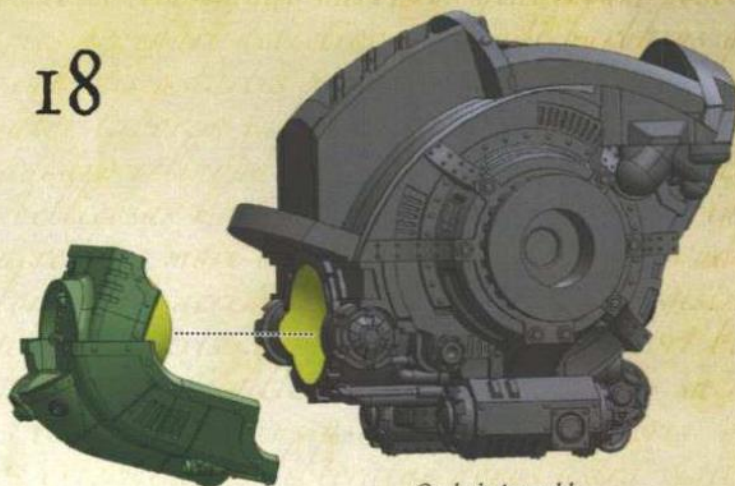

Cockpit Assembly

2. Gorget Plate

19

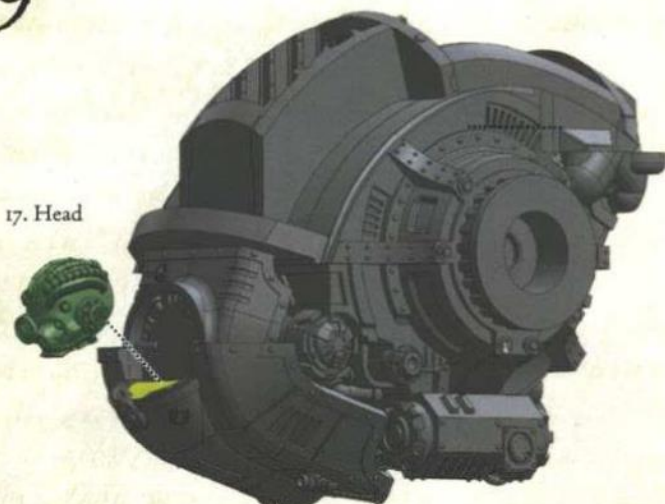

Cockpit Assembly

17. Head

20

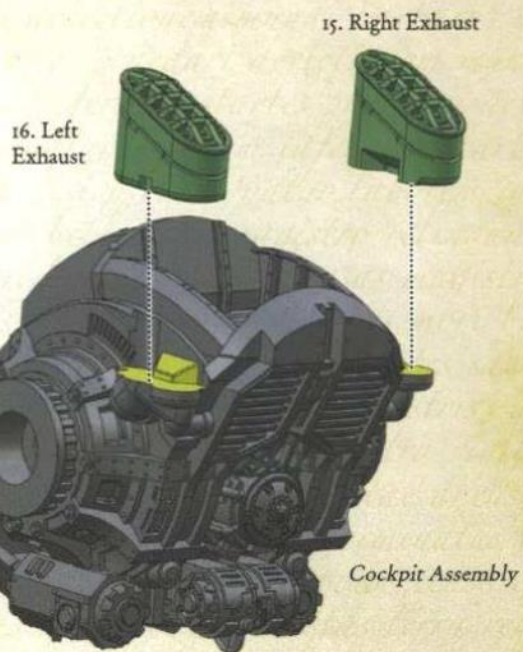

15. Right Exhaust

16. Left Exhaust

Cockpit Assembly

21

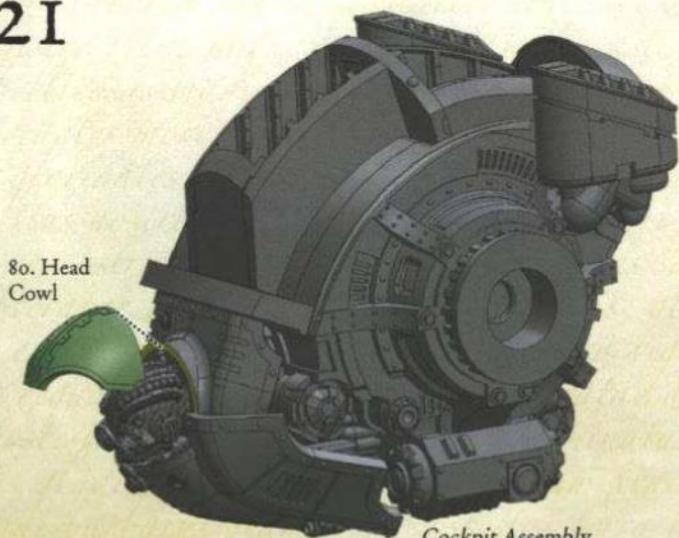

Cockpit Assembly

80. Head Cowl

22

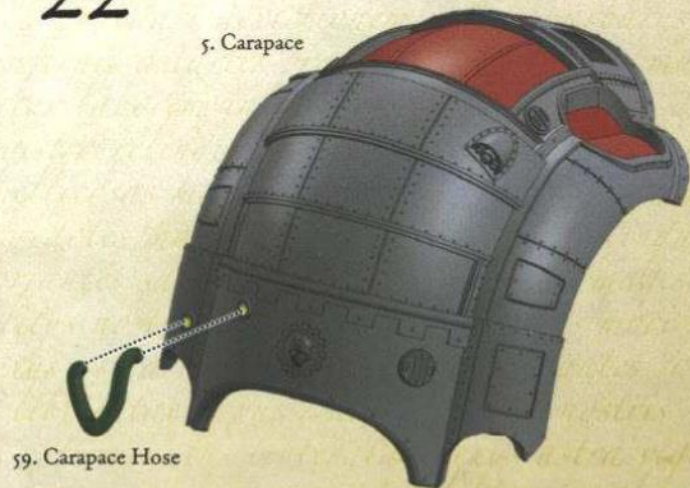

5. Carapace

59. Carapace Hose



23

Carapace Assembly



Cockpit Assembly

24

28. Karacnos Mortar Cowl

79. Upper Karacnos Mortar Rack

78. Mid Karacnos Mortar Rack



77. Lower Karacnos Mortar Rack

25

Karacnos Mortar Assembly

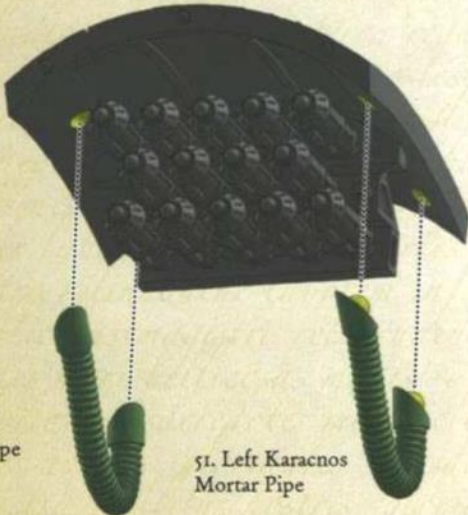

50. Right Karacnos Mortar Pipe

51. Left Karacnos Mortar Pipe

26

Karacnos Mortar Assembly

60. Left Hood Hinge

61. Right Hood Hinge



27

Karacnos Mortar Assembly



Torso Assembly

28

53. Volkite Linkage Pin

67. Secondary Weapon Linkage Pin

86. Right Volkite Culverin

62. Right Secondary Weapon Power Cable

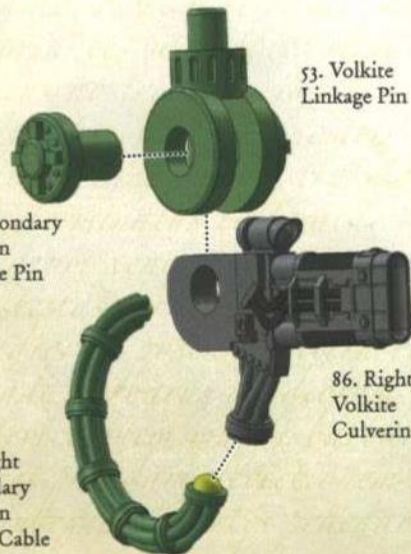

29

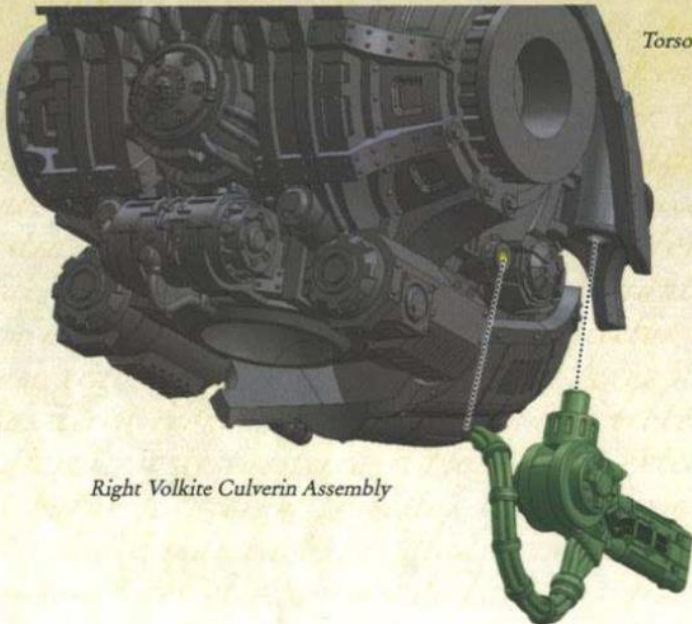

30

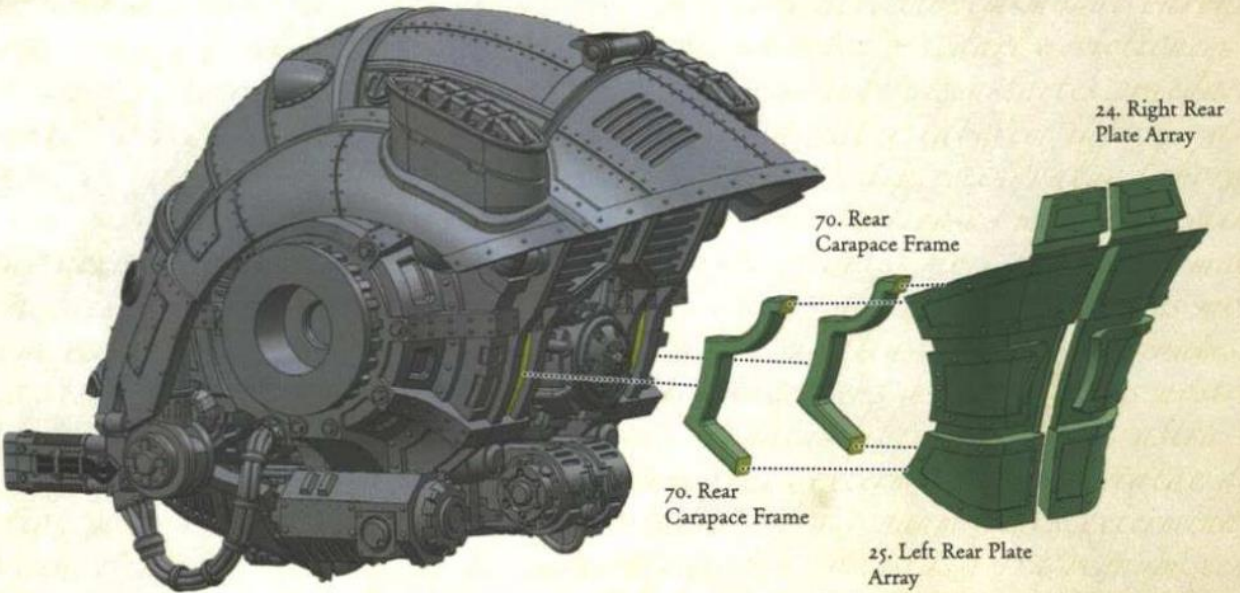

31

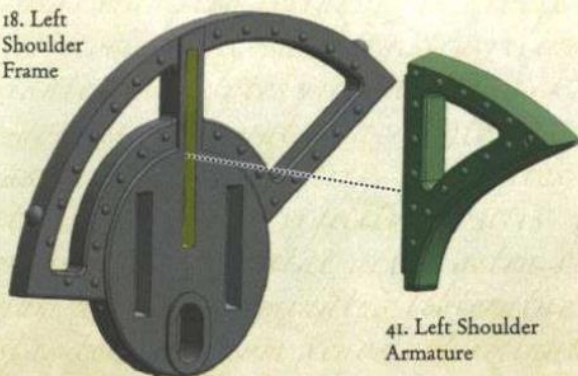

32



Stages 31 to 48 show the assembly of the left arm and Twin-linked Conversion Beam Cannon. Repeat these stages for the right arm.

33

Arm Assembly

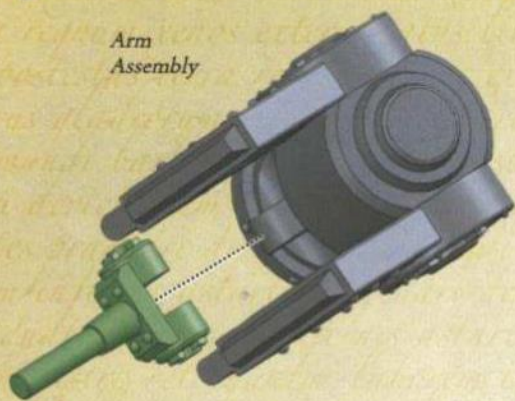

58. Pivot Pin

34

Shoulder Assembly

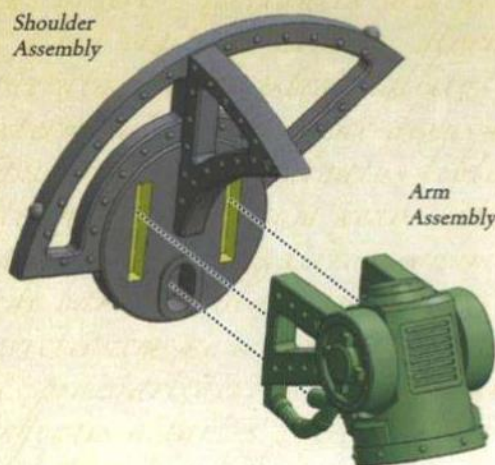

Arm Assembly

35

Arm Assembly

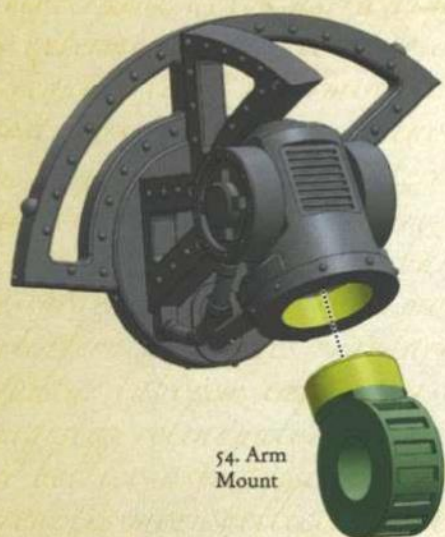

54. Arm Mount

36

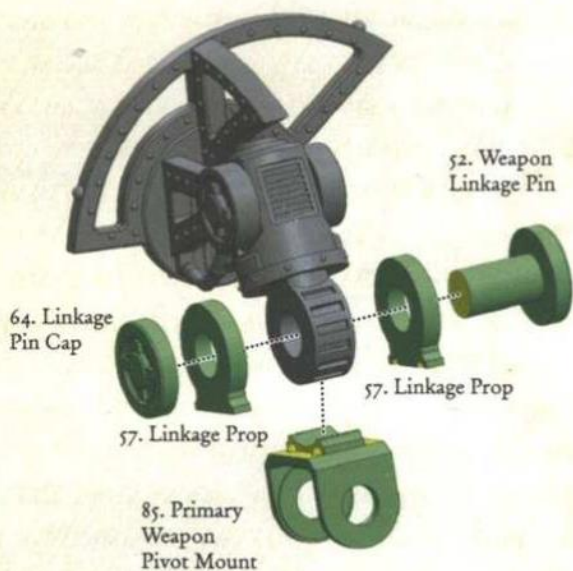

52. Weapon Linkage Pin

64. Linkage Pin Cap

57. Linkage Prop

57. Linkage Prop

85. Primary Weapon Pivot Mount

37

88. Left Shoulder Plate



Arm Assembly

38

11. Conversion Beam Cannon



34. Conversion Beam Cannon Power Regulator

# 39

Conversion Beam Cannon Assembly

74. Conversion Beam Cannon Coil



74. Conversion Beam Cannon Coil

# 40

Conversion Beam Cannon Assembly



47. Conversion Beam Cannon Power Cable

# 41

Conversion Beam Cannon Assembly

44. Conversion Beam Cannon Cooling Cable 4



43. Conversion Beam Cannon Cooling Cable 3

# 42

Conversion Beam Cannon Assembly

40. Conversion Beam Cannon Cooling Cable 2



39. Conversion Beam Cannon Cooling Cable 1

# 43

Conversion Beam Cannon Assembly

33. Upper Conversion Beam Cannon Coil Frame



36. Conversion Beam Cannon Support Frame

35. Lower Conversion Beam Cannon Coil Frame

# 44

Conversion Beam Cannon Assembly

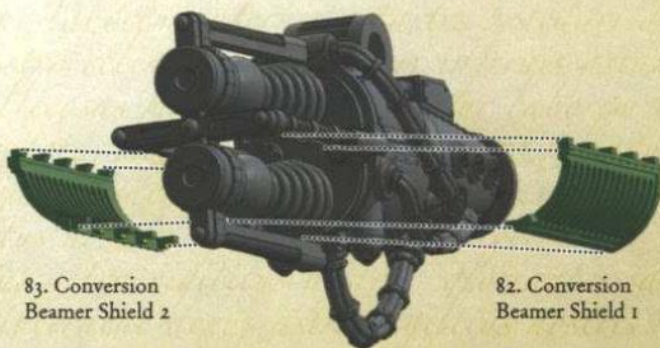

83. Conversion Beamer Shield 2

82. Conversion Beamer Shield 1

45

Conversion Beam Cannon Assembly

82. Conversion  
Beamer Shield 1



83. Conversion  
Beamer Shield 2

46

Conversion Beam Cannon Assembly

66. Conversion Beam Cannon  
Energy Collection Dish



65. Conversion  
Beam Cannon  
Emitter

65. Conversion  
Beam Cannon  
Emitter

66. Conversion Beam Cannon  
Energy Collection Dish

48

Left Arm  
Assembly



55. Primary  
Weapon  
Linkage Pin

55. Primary  
Weapon  
Linkage Pin

Conversion  
Beam Cannon  
Assembly



49



Torso Assembly

Right Arm  
Assembly

Left Arm  
Assembly

50

Upper Body  
Assembly



Legs Assembly

© Copyright Games Workshop Limited  
2019. All rights reserved.

**GAMES  
WORKSHOP**

games-workshop.com

www.forgeworld.co.uk

**Forge World**