

GAMES WORKSHOP

COMPLETE CATALOG & HOBBY REFERENCE



2005-2006 EDITION

GAMES WORKSHOP

COMPLETE CATALOG & HOBBY REFERENCE



PRODUCED BY GAMES WORKSHOP

Copyright © Games Workshop Limited 2005 excepting all materials pertaining to the New Line theatrical productions: *The Fellowship of the Ring*; *The Two Towers*; and *The Return of The King* which are © MMV New Line Productions, Inc. All Rights Reserved. *The Lord of The Rings*, *The Fellowship of The Ring*, *The Two Towers*, *The Return of The King* and the names of the characters, items, events and places therein are trademarks of The Saul Zaentz Company d/b/a Tolkien Enterprises under license to New Line Productions, Inc. All Rights Reserved. Games Workshop, the Games Workshop logo, 'Eavy Metal, Citadel and the Citadel device are either ®, TM and/or © Games Workshop Ltd 2000-2005, variably registered in the UK and other countries around the world. All Rights Reserved.



USA
GAMES WORKSHOP INC.
6721 Baymeadow Drive,
Glen Burnie, MD
21060-6401

CANADA
GAMES WORKSHOP
2679 Bristol Circle,
Unit #3,
Oakville, Ontario
L6H 6Z8

UK
GAMES WORKSHOP LTD.
Willow Road,
Lenton,
Nottingham
NG7 2WS

AUSTRALIA
GAMES WORKSHOP
23 Liverpool Street,
Ingleburn,
NSW 2565

HONG KONG
GAMES WORKSHOP LTD
20th Floor,
Leader Centre,
37 Wong Chuk Hang Rd

JAPAN
GAMES WORKSHOP LTD
Willow Road,
Lenton,
Nottingham
NG7 2WS

HARDBACK ISBN: 1-84154-598-8
HARDBACK PRODUCT CODE: 13049999002

Games Workshop World Wide Web site:
<http://www.games-workshop.com>

SOFTBACK ISBN: 1-84154-597-X
SOFTBACK PRODUCT CODE: 13049999001

DESIGN & LAYOUT

Nicole Shewchuk, Stuart Spengler,
and William "Goat" Stilwell

PRODUCTION

US: Drew Will, Len Sullivan,
Sean Forbes, Jeff Cauley, and
the US Direct Services staff

UK: Sharon Cooke, Sean Cutler,
Andy Hallam, Zaff Haydn-Davies,
Chris Lucas, and Simon Smith

TEXT & EDITING

Eric Sarlin, Dave Taylor, Ken Kennedy,
Jeremy Vetock, and Ross Watson

ADDITIONAL CONTRIBUTIONS

Jason Buyaki, Rich Curren, Nick Davis,
Jason Foley, Steve Fuller, Chris
Gohlinghorst, Jeff Hall, Rob Hawkins,
Jake Landis, Chris McPherson, Chad
Mierzwa, Graeme Nicoll, John Shaffer,
Pete Underwood, and Tim Vincent

SPECIAL THANKS

A special thank you goes out to all of
the Golden Demon and Grand
Tournament winners and contestants
from across the globe, the staff of both
the US and UK Studios, and last but
not least, our dedicated Games
Workshop hobbyists!

Printed by RR Donnelley

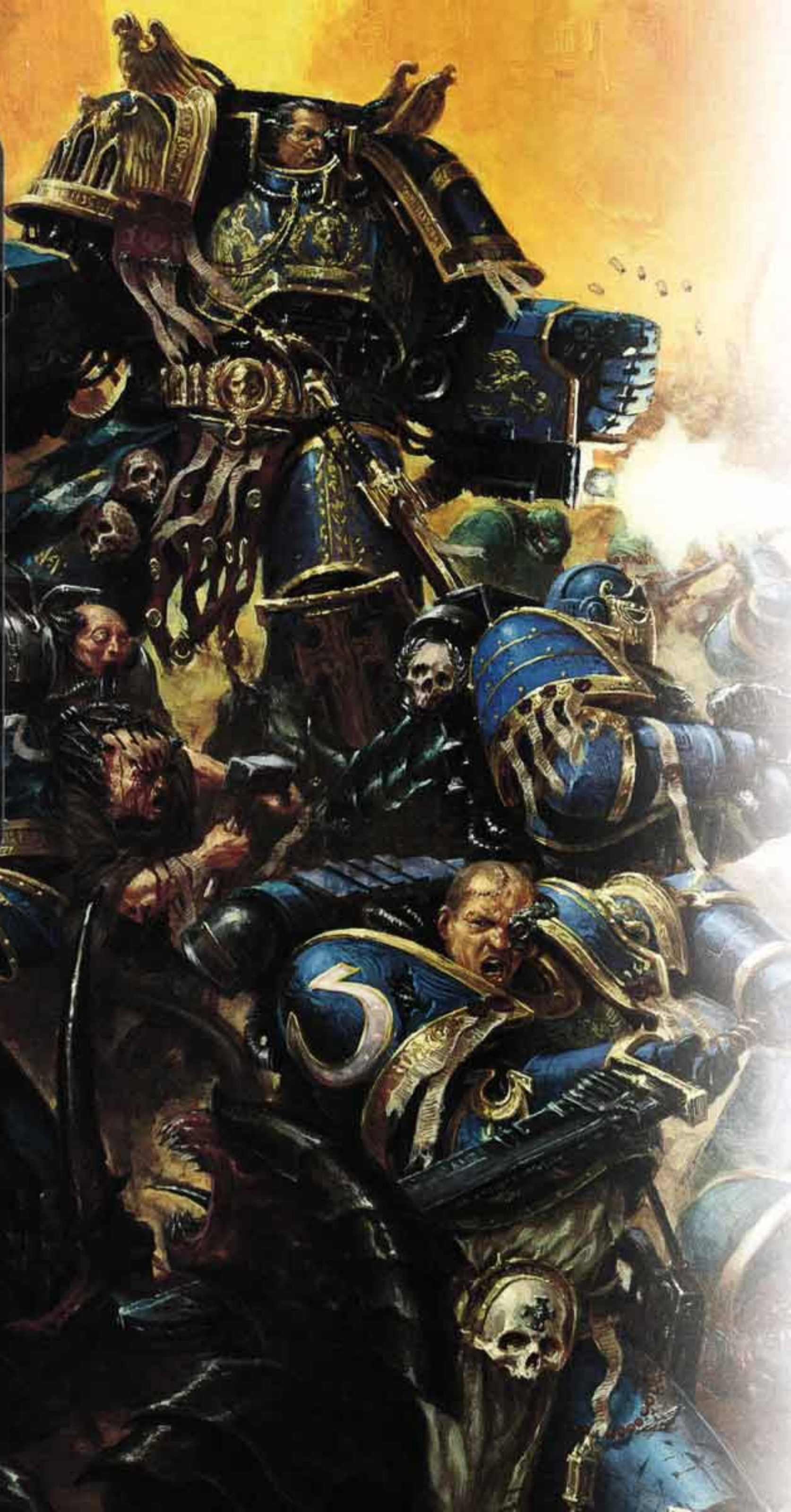

TABLE OF CONTENTS

Intro

Using This Catalog 2

What do the icons mean? How can I order bits separately? Find your answers here!

Chaos Creatures 12

Chaos creatures from both the Warhammer 40,000 and Warhammer ranges.

Warhammer 40,000

Warhammer 40,000 30

In the grim darkness of the far future, there is only war.

Chaos Space Marines 34

Dark Eldar 70

Eldar 88

Imperial Guard 110

Inquisition 138

Daemonhunters & Witch Hunters

Necrons 164

Orks 176

Space Marines 196

Tau 258

Tyranids 272

Warhammer

Warhammer 288

Take command of rank after rank of battle-hardened warriors and maneuver them to victory.

Beasts of Chaos 292

Bretonnians 312

Dark Elves 332

Dogs of War 354

Dwarfs 372

Empire 390

High Elves 418

Hordes of Chaos 438

Warhammer (Cont'd)

Lizardmen 460

Ogre Kingdoms 478

Orcs & Goblins 498

Skaven 526

Tomb Kings 544

Vampire Counts 562

Wood Elves 586

Warhammer Siege 606

The Lord of The Rings

The Lord of The Rings Strategy Battle Game 610

The battle between Good and Evil rages from your tabletop to the ends of Middle-earth.

Other Great Stuff!

Specialist Games 644

Battlefleet Gothic, Blood Bowl, Epic, Inquisitor, Mordheim, Necromunda, and Warmaster!

Hobby Supplies 652

Paints, brushes, and glue, oh my!

Direct Services 662

Mail Order, Customer Services, and the Online Store!

Games Workshop Hobby Centers .. 664

Get anything from our entire line of current products or stop by to game or learn to paint!

Rogue Trader Stores 666

Purchase your miniatures or find new opponents at these independent retail shops.

Games Day 667

Our celebration of the hobby at four locations across the US

White Dwarf Subscriptions 668

Our monthly hobby magazine

Games Workshop Online 669

Locate stores, see the newest releases, and check out *Black Gobbo*, our bi-weekly E-zine!



USING THIS CATALOG

What You'll Find Inside

The mighty tome you now hold in your hands, *The Complete Games Workshop Catalog and Hobby Reference* (2005-2006 Edition), is jammed with photos of Citadel Miniatures and of all the products (games, rulebooks, paints, terrain, and more) that are available from Games Workshop.

Because there are so many product codes and different ways to buy GW products, this section provides all the information you need to get your hands (or claws, talons, powerfists, or tentacles) on all that great Games Workshop merchandise.

The Miniatures

While you'll find games, rulebooks, and hobby supplies, it is the matchless Citadel Miniatures that rule the catalog. Each available model will be listed as follows.

In All Their Forms

Games Workshop sells its models in **boxed sets**, in **blister packs**, and as **component parts**. Throughout the catalog, models are shown assembled, painted, and on their appropriate bases. Each catalog entry specifies whether it is a boxed set, a blister pack, or an individual part (hereafter referred to as a "bit" or "bitz"). For each boxed set of plastic miniatures, the catalog will show assembled and painted models as well as the plastic "sprues" so that hobbyists can see the variety of pieces that make up the models.

Most gamers, painters, and collectors will want to buy whole models, but some hobbyists will want to purchase the separate parts for conversion and modeling purposes. Thus, every individual piece that is available for sale is shown, coded, and listed on the separate price list.

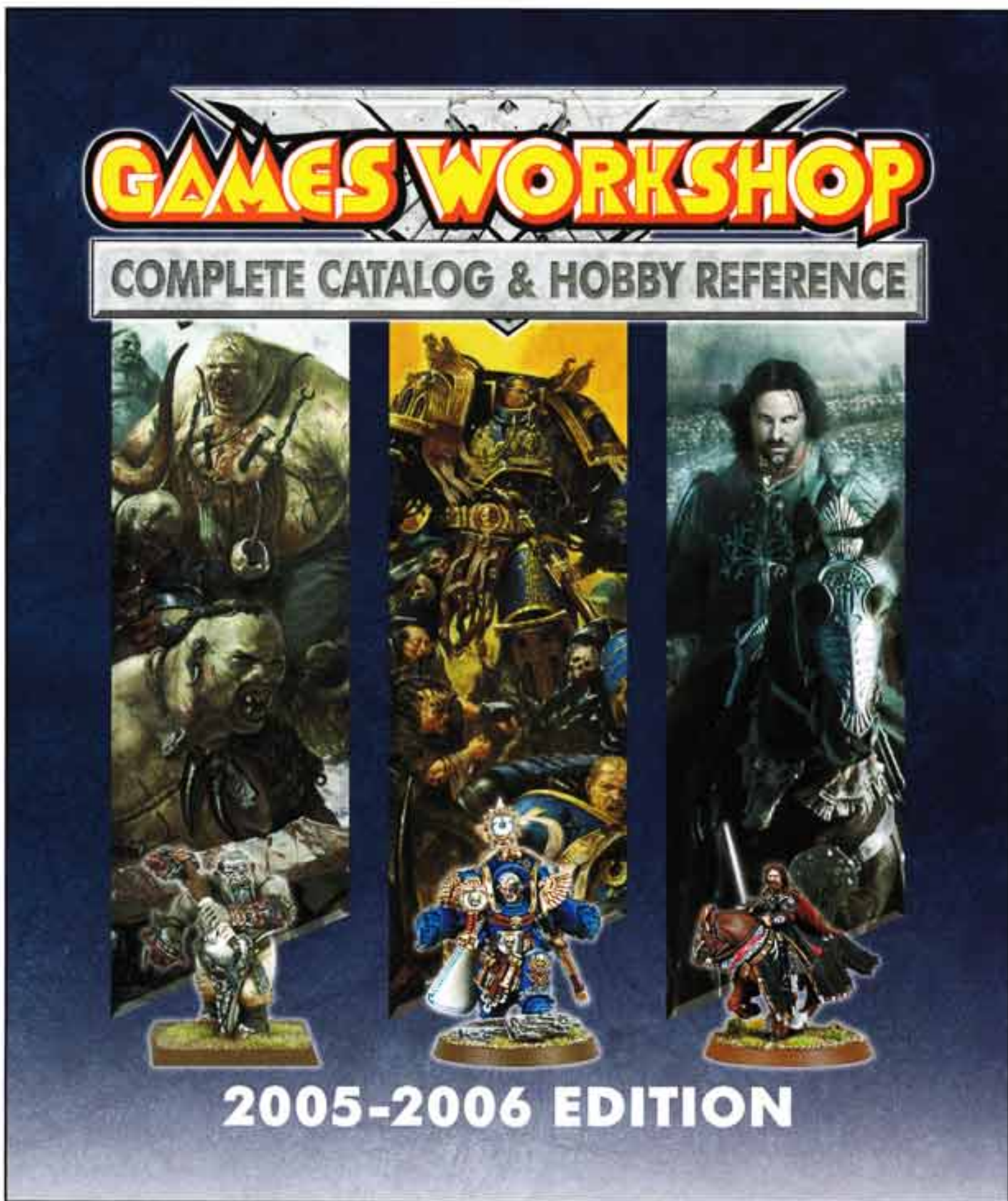

From the manifested horrors of Chaos to the deadly grace of the Eldar – the Citadel Miniatures range is staggering in depth and detail!

Codes and Price Lists

Codes identify each product, and these codes will match up with the Price List. All blisters, boxes, bitsz, and sprues shown in each section will have their prices listed in the appropriate section of the price list.

Where Is This Stuff Available?

All of the products in the catalog are available from participating Independent Retail shops (often called Rogue Traders), Games Workshop Hobby Centers, and the GW Mail Order Service at:

1-800-394-GAME

and the Online Store at:

<http://store.us.games-workshop.com>

This point is so important that we had to emphasize it below. If your local shop carries ANY Games Workshop products, then it has access to EVERYTHING in this enormous Catalog. Ask the staff of your local shop today!

All the models in this catalog can be purchased from Independent Retailers, Games Workshop Hobby Centers, as well as Games Workshop Mail Order and the Games Workshop web site.

Safety First

Citadel Miniatures are fine-scale models designed for gamers and collectors. Due to the small and pointed components of Citadel Miniatures, they are NOT RECOMMENDED FOR CHILDREN UNDER THE AGE OF 12.

Hobbyists of any age should be careful when modeling. Hobby knives, files, clippers, and more can cause bodily harm if used incorrectly. Always be sure to read and follow the instructions on the packaging when using any type of glue or spray primer. By having a thorough understanding of the product and following the proper procedures, any modeler can enjoy the Games Workshop hobby in complete safety.

Citadel Miniatures are not recommended for children under the age of 12.

New Models Replace Old

Over the years, Games Workshop has made many fantastic models, and we have no plans of stopping! During that time, entire ranges of Citadel Miniatures have been replaced with newer, better models. However, no matter how much better the new miniatures are, the older versions were always somebody's favorite! Therefore, whenever possible, we continue to sell these "Classic" models. While the majority of these models are not pictured in this catalog, many of them are still available. Contact Direct Services or visit our web site or one of our Hobby Centers to check on availability.

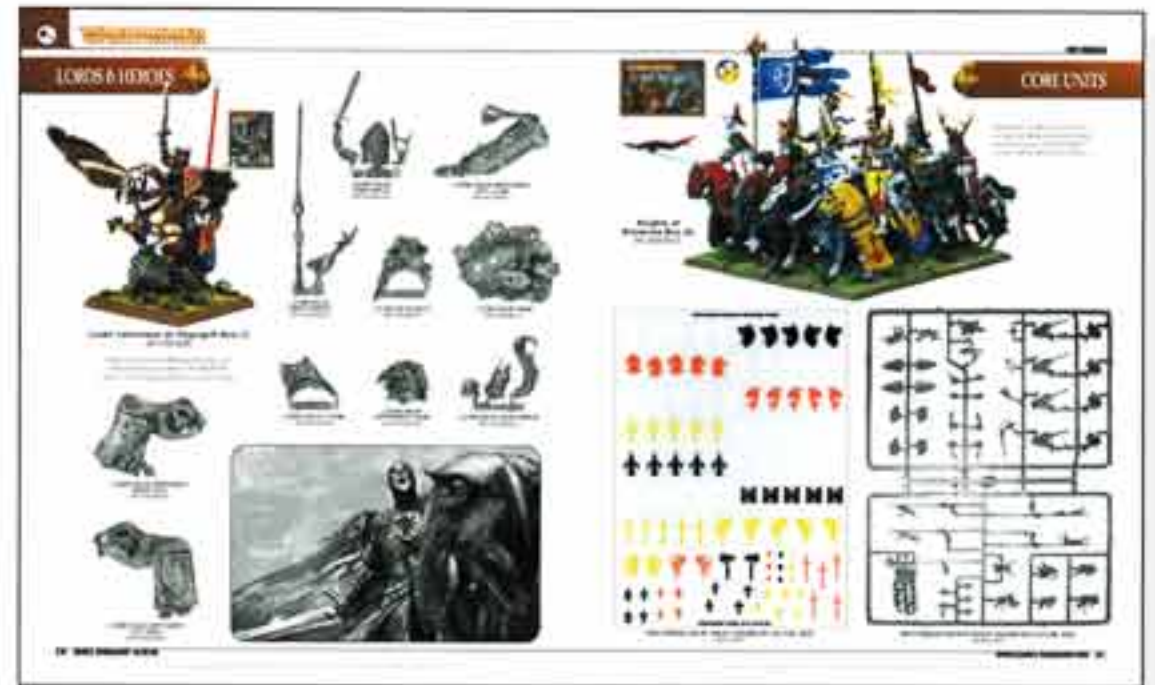



Specialist Range

The Specialist Range is made up of all the available Specialist Games and their model ranges, including those for the Battlefleet Gothic, Blood Bowl, Inquisitor, Mordheim, Necromunda, Warmaster, and Epic 40,000 games. These games are well supported with great miniature lines available through the Online Store and Direct Services.

Classic and Collector's Range

The icon to the right denotes items that are Special Offers. You won't normally find these items on the shelves in your local Independent Retailer or GW Hobby Center. You can place a special order for these items at your local GW Hobby Center and most Independent Retailers. All Special Offer items found in this catalog will be marked with the Special Offer Icon.

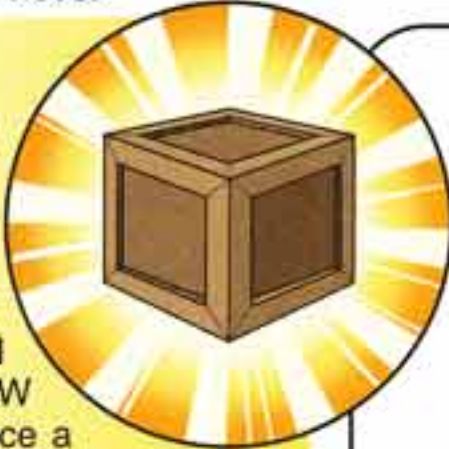

Promotional Range

On occasion, Games Workshop produces a few Promotional models for events such as major Battle Tours, Games Days, or perhaps a new game launch. These models are limited editions, as they are ONLY for sale at the event and are not otherwise available. We have included some of these models in this catalog, but they will NOT have codes, nor may they be ordered through any of our sales channels.



Above: This promotional Witch Hunter Inquisitor was available at Warlords Weekend.

Out of Stock

While GW tries not to run out of stock of any products, there are occasionally forces beyond our control. Even if we do run out of stock on a few items, our improved manufacturing system will have the items back in stock in no time. However, there may be exceptions.

Models from older ranges may suffer when their molds become worn out. If we cannot repair or replace the molds, then we will retire the model from the available range rather than sell poorly cast figures.

If any models have dropped from availability, updates will be sent to Rogue Traders, Games Workshop Hobby Centers, and our Mail Order Division and will also be noted on our web site. Again, we do not anticipate any such incidents, but over the years, we've learned that it happens on occasion.

Unassembled & Unpainted

In this catalog, models and bitz are shown in a variety of ways – painted, unpainted, in pieces, and fully assembled. Games Workshop models are always sold as unassembled and unpainted. The painted and assembled models are shown to provide both a clear

picture of the finished product and an inspiration to the modeler and painter.

Full models (not bitz) are sold with the appropriate plastic base that is specified by the game rules. For instance, an Imperial Guard trooper is supplied with a 25-mm round base, while an Ogre will come with a 40-mm square base.

The size of Citadel Miniatures can be very different. Some are huge (like a Giant or Carnifex), while some are relatively small (Gnoblar). Where possible, models are shown at ACTUAL SIZE in the catalog. In some cases, the models are shown a bit smaller, and this fact is noted where relevant throughout the catalog.



**All models are supplied unpainted:
Models, bitz, and plastic sprues are shown
at actual size unless otherwise noted.**

How the Catalog Is Organized

When you start to flip through something as massive as The Complete Games Workshop Catalog and Hobby Reference (2005–2006 Edition), it is best if you have an idea of how things are laid out and what you can expect to find in each section.

Organized by Game

The catalog is organized by Game System. The first part of any section will cover the game, what it is, how to get started, and the core products: rulebooks, annuals, and supplements. Next, the armies, warbands, fleets, or teams for that game will be covered.

Army Organization

Warhammer 40,000 and Warhammer armies are displayed in basically the same way.

Introduction. A bit of background on the army and a brief synopsis on its fighting style.

Getting Started. The relevant Codex/Army books and any Battle Force or Battalion starter force boxes.

By Codex or Army Book. The models for the armies are then organized per their Codex or Army books. Thus, for Warhammer 40,000 armies, HQ choices are first and are followed by Elites, Troops, Fast Attack, and

Heavy Support. For Warhammer armies, Lords & Heroes are listed first and are followed by Core, Special, and Rare choices.

Hobby Stuff

Colors of War. The Colors of War sections show off a lot of different color schemes that can be used to paint the models. These sections can help hobbyists choose a color scheme for their own army or perhaps inspire them to create their own unique version.

Showcase. At the end of each army, we spotlight models in a showcase. These awesome and eye-catching armies are often painted by Grand Tournament contestants from around the world and will give the reader an inspirational rendition of the featured army. There are plenty of ideas to be found in the showcase. With the plethora of a bitz to be found on these pages, you should have no trouble in finding ideas to make your own miniature masterpieces.

Hobby Material. Throughout each section are hobby tips, step-by-steps, and as many great examples as we could pack in. We have included showcases of completed armies and converted models. Terrain has not been overlooked, and we showcase battlefields or terrain pieces for almost every army.

Alternate Models. In the Showcase section, we include a few converted models and list the bitz and a difficulty rating for those hobbyists interested in trying their hand at a conversion. Included here are component codes as well as any Special Offer Bitz that are not shown elsewhere in the Catalog. If you're looking for a unique addition to your force, this section is for you!

COMPLEXITY RATING



Tactics & Countertactics

At the end of each section, tactics for the army are given to help if you are starting the army and need help in getting a feel for how it works. In case you are having trouble with a particular army, countertactics give you ideas on how to defeat your opponent. Within each section, there may be units that have tactics that are particularly suited to them. When the icon above right appears next to a unit or troop type, look for an associated strategic tip later on in the section.



Exceptions

Of course, with a catalog of this size, there are bound to be exceptions to the rules. For example, the Chaos Creatures section includes models that can be used in both the Warhammer 40,000 and Warhammer.

GAME SYSTEM

This small icon lets you know quickly which section of the catalog you are flipping through.



HEADER FOR SECTION

Each army for Warhammer 40,000 or Warhammer is labeled with these headers to let you know what you are looking at.



HOBBY PROJECTS

In addition to showing off the amazing models and bitz, the catalog has worked in lots of hobby tips, painting step-by-steps, advice, and examples.

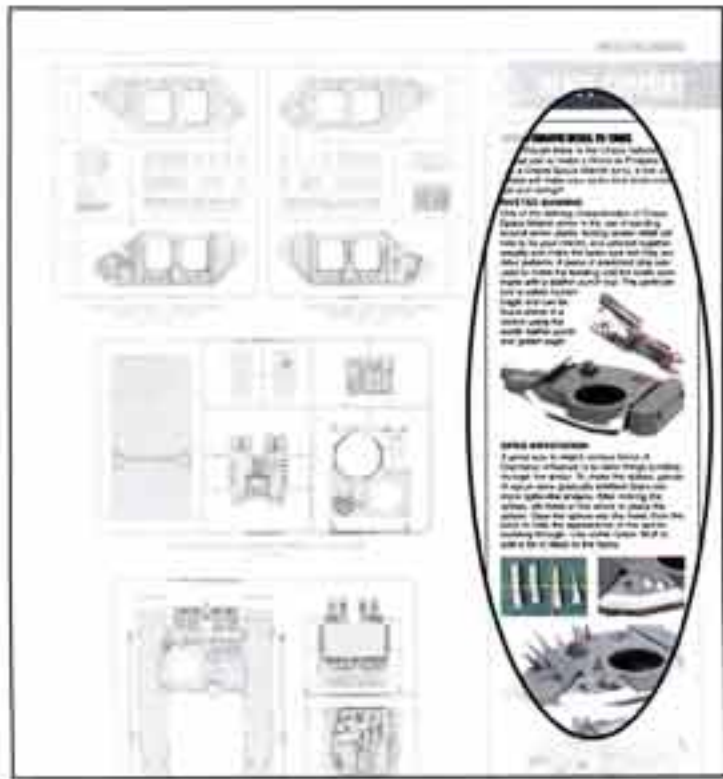

How Is It Packaged?

The many models shown in this catalog are packaged and sold in a wide variety of ways. To ensure that the hobbyist can find and receive exactly what he/she is looking for, we define here what each label means. The goal of this section is to point out how to read the labels and clarify what is meant by each of the packaging terms. Models are available in the following packages.

Box or Boxed Set. These terms denote the packaging of either a set of models or a larger multiple-piece model that is sold in a box. If the description says "Random," then the mix of models in the box may differ slightly.



Bolt Throwing Crew (1 Bolt Throwing Crew & 2 Crew)
99120210006

Blister Packs. This term refers to a particular type of packaging, a plastic bubble that holds models to a piece of card. If you were to order a Blister Pack code that said "Random," you would receive a random variation of the available models from that code.

Note that the catalog does not show the blister pack but instead shows the assembled models that are enclosed.



Ogre Maneater Blister (Random 1)
99060213007



**PAYMASTER MANEATER
RIGHT ARM**
9947021300709



**PAYMASTER MANEATER
SPRUE**
9947021300706



PIRATE MANEATER GUTPLATE
9947021300713



PIRATE MANEATER HEAD
9947021300711



PAYMASTER MANEATER BODY
9947021300707



**PAYMASTER MANEATER
GUTPLATE**
9947021300708



PIRATE MANEATER BODY
9947021300712



PIRATE MANEATER ARMS
9947021300714

Bitz. This term refers to a component piece that makes up a complete model that would normally be sold in a Blister Pack or Box. Bitz have longer 12-digit codes and are shown unpainted. No additional plastic parts, such as miniature bases, plastic shields, or mounts (like horses or wolves) are included with bitz sales.

Some single-piece models may be given both a blister and a bitz code. Where this is the case, each code will be labeled clearly so that customers can ascertain whether they are getting the blister (complete with all necessary plastics, bases, etc.) or the bit.



Eldrad Ulthran, Farseer of Ulthwé Blister (1)

99060104027

BIT NAME: ELDRAD ULTHRAN
BIT CODE: 9947010402701



Farseer Blister (1)

99060104068



FARSEER BODY
9947010406801



FARSEER SPEAR
9947010406802

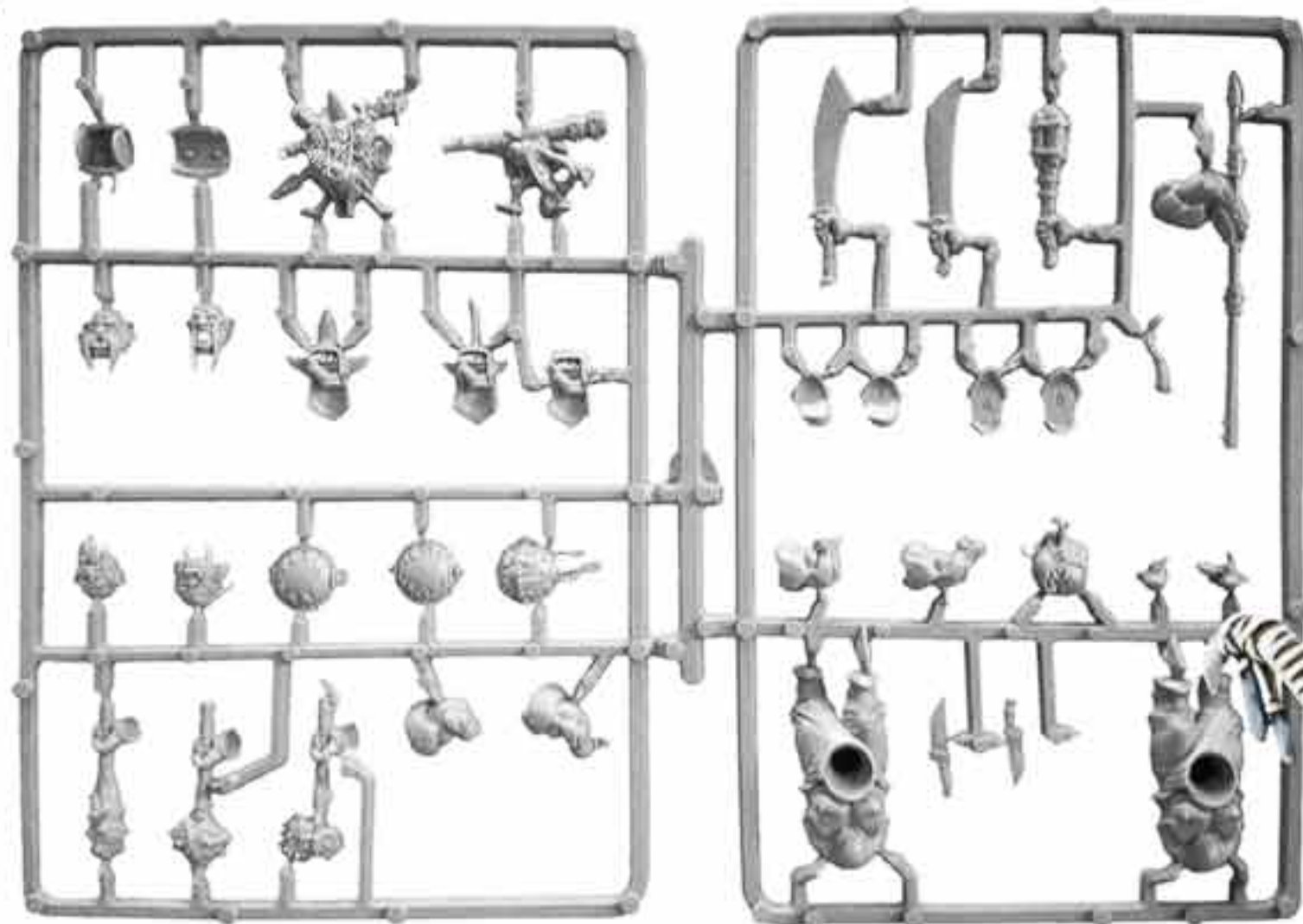

OGRE BULLS SPRUE (SHOWN 50% ACTUAL SIZE)
99380213005

Plastic Sprues. "Sprue" describes the plastic "frames" of plastic models or pieces. Each sprue comes with detailed component parts that must be cut out and assembled. There are boxed sets of many plastic sprues (to build an entire squad or unit), and most sprues are also available as independent bitz.

Some plastic sprues are accessories, like plastic shields or plastic Space Marine backpacks. Other plastic sprues are used to make up complete plastic Citadel Miniatures. In the case of complete plastic models, there are countless ways to assemble the plastic components, so we always try to show a few finished examples so that readers will know what the finished product looks like.

Shown here are a plastic sprue labeled as a bit, a boxed regiment full of plastic sprues, and some of the fantastic models that can be assembled from those pieces.



Ogre Bulls Box (6)
99120213001





Multiple Options

At times, there are multiple ways to buy the same figure. Here, the Chaos Knights from the Warhammer Chaos army will serve as our example.

OPTION 1. If you want to buy only a single model, look for a label similar to the one below.

Knights of Chaos Blister (Random 1)
99060201129

The label of "Random 1" means that, if you order the code 99060201129, you will receive one of the Chaos Knights. As there are multiple models with the same code, the blister is packed randomly. If you are at a Rogue Trader shop or Games Workshop Hobby Center, you can shuffle through the blisters and pick exactly which one you want.

OPTION 2. The next option is under the color picture that shows all the available models painted and reads something like the caption below.

Knights of Chaos Regiment Box (5)
99110201126

This label does NOT say "Random." Thus, the models pictured are the ones that come in the box. This option is perfect if you're looking to build a unit of Chaos Knights.

OPTION 3. The third way you may purchase a Chaos Knight is as individual bitz. Each of the separate parts that make up the complete models you find in the box are broken down and coded for sale as individual pieces. Bitz are a great option for serious hobbyists looking for exact pieces, but they will have to be special ordered and are sold at a premium price. It is slightly cheaper to order the random blister of one Chaos Knight than to order the specific component bitz that will make up the model.

WHERE? Better stores should stock options 1 and 2. To get option 3 (the bitz), you can ask your favorite shop to place an order for you or try our Online Store or Mail Order Service.



FREQUENTLY ASKED QUESTIONS

Random or Not?

Remember, the only time you will receive random miniatures is when you order a code that has "Random" marked next to it.

Random packaging is done when there are a multitude of models that have exactly the same code. If purchasing a particular model is important to you, the best routes to take are either to get to a store that carries a wide selection of Games Workshop products and find the variant on the shelves or to place a special order and order the exact model you want as bitz.

Will This Catalog Ever Be out of Date?

The bad news is that, yes, *The Complete Games Workshop Catalog and Hobby Reference* will be out of date at some point. The good news is that it will be out of date because there are new Games Workshop models, accessories, games, and more coming out all the time.

Hobbyists can keep up to date with the latest releases by checking out *White Dwarf* magazine and by visiting the Games Workshop web site.



Striking Scorpions Blister (Random 2)
99060104076

There are three variants of models in the 99060104076 Eldar Striking Scorpion Blister main range code. It is a randomly packed blister that will contain any two different Eldar Striking Scorpions of the three models available in the code.

It is also possible that, during the course of the ongoing year, Games Workshop may have to drop a few codes of miniatures due to mold deterioration. When codes are lost, for

any reason, updates will be posted on our web site as well as sent out to all Rogue Trader shops and Games Workshop Hobby Centers.

For help with this catalog or any Games Workshop products, call our Hobby Specialists at 1-800-394-4263 (GAME).

How Do I Purchase Items Shown in This Catalog?

If you are looking to purchase Special Offer models or if you are after individual bitz or pieces then you can place a special order straight from your favorite store. Just ask a staff member to place a special order for Games Workshop.

While it is true that our products are easier to find than they were years ago, you may still live far away from any shops that carry Games Workshop merchandise. Or it could be, for some reason, that your local store does not want to participate in our special

ordering program. Games Workshop has a toll-free Mail Order Service that is fast and efficient as well as a fantastic Online Store.

Finding a Store Near You

Every other month, we print a Retailer List in *White Dwarf* magazine that groups all the Independent Rogue Trader stores and Games Workshop Hobby Centers by State or Province. On our web site, under Shopping, you can also run a search to find the store nearest you. You can also place a call toll-free (1-800-394-GAME) to our Mail Order Staff who will happily assist you in finding a local shop.

How Can I Get Catalog Help?

We have done our best to design this catalog in an easy-to-follow method so that hobbyists can find what they want. However, if you have a question that just doesn't seem to be answered in this catalog, we are happy to answer all questions. The best way to get in touch with us is to call us at:

1-800-394-4263 (GAME)

This number is our Mail Order line crewed by Hobby Specialists who know the catalog, the Games Workshop range, and the Hobby. So whether your question is about basics and getting started or bitz variants for incredibly complex conversions, just give us a call.



Above: The front of the Games Workshop web site. Going online is a great way to get caught up on all the new releases.

Right: Games Workshop's monthly magazine is *White Dwarf*, which features pages of new releases in every issue.





COMPLETE CATALOG POLICIES

Defective Parts

Games Workshop strives for 100% Customer Satisfaction, and we will replace defective or damaged parts of any of our games or models.

If you have a damaged item, keep the original packaging and do the following:

- Take the defective item back to the store from which you purchased it. Most stores will gladly replace the damaged piece.
- If, for any reason, the store in question cannot make the exchange, give our Mail Order number a call (number below).
- If you purchased the defective item from Games Workshop Mail Order or our Online Store, just give us a call at:

1-800-394-4263 (GAME)

Coding & Prices

Games Workshop reserves the right to correct errors and modify prices as they appear in this catalog. All prices in *The Complete Games Workshop Catalog and Hobby Reference (2005–2006 Edition)* are subject to change. Price updates, if any, will be sent to Independent Retailers and our Hobby Centers as well as posted on our web site.

Returns

It is conceivable that you may find yourself with an undamaged Games Workshop item that you do not want. Perhaps a well meaning relative or friend purchased a duplicate item for your army, or maybe you just picked up the wrong box and didn't notice until you got home. If you can't fit it into your army/collection/painting plans, then you will want to make a return.

Independent Retailers set their own policies for returns, refunds, store credit, and exchanges. We suggest you ask about the

store policy before purchasing major items, as some shops may be unable or unwilling to accept returns.

Games Workshop's Return Policies

- Games Workshop Hobby Centers accept returns for exchange on packaged, current range products only. The boxed set, blister pack, book, or game must be in saleable condition, i.e., unopened and undamaged. Refunds are also available on returns but only within 30 days of purchase and when accompanied by the original sales receipt. Some limitations and exceptions may apply. Please see the individual Hobby Center manager for more details.
- Games Workshop Direct Services (Mail Order and the Online Store) accept returns for exchange on packaged, current range products only. The boxed set, blister pack, book, or game must be in saleable condition, i.e., unopened and undamaged. Refunds are available only to customers of Direct Services within 60 days of purchase. Some limitations and exceptions may apply. Please contact Direct Services at 1-800-394-4263 (GAME) to obtain a return authorization before sending any products.
- Games Workshop **CANNOT** accept returns on bitz so be very careful when writing down codes and numbers to ensure you are getting the models you want.

If you have an item that you would like to return to Games Workshop, give us a call (1-800-394-GAME) and we will be glad to help you out.

Please note these Return Policies are for customers. Independent Retailers should contact their Sales Representative to discuss replacement products or returns.



Special Note to Independent Retailers

It is obviously impractical for any store to attempt to carry every game, model, and bit that Games Workshop makes. However, *The Complete Games Workshop Catalog and Hobby Reference (2005–2006 Edition)* makes sure that any store stocking any Games Workshop products can special order even the most obscure and unusual bit in our entire product line. This voluminous book is a gateway to vast amount of models, bitz, and more.

Games Workshop has produced a small packet of materials that can help any Independent Retailer understand the Special Order process and also help Retailers advertise to their customers that their store is the place to order all bitz and other special needs. If you're an Independent Retailer and have not yet received a catalog and a retailer's guide, please contact your Sales Representative right away.

Games Workshop strives for 100% Customer Satisfaction.

GETTING THE MOST OUT OF HIS CATALOG

An Invaluable Resource

Army builders, painters, collectors, modelers, and terrain builders will find *The Complete Games Workshop Catalog and Hobby Reference (2005–2006 Edition)* to be an invaluable resource and inspiration for any of their projects. On this page, we've tried to gather some tips, tricks, ideas, and suggestion to help you get the most out of this Catalog.

Tactics & Countertactics

While the main thrust of this catalog is toward the painting and converting aspect of the hobby, the gaming aspect is not entirely left out in the cold. After all, after spending hours crafting and painting your latest unit, it isn't any fun at all for it to be wiped out on the 1st turn of the game. To help you get the most out of your hobby, Tactics and Countertactics can be found at the end of each section.

Conversions

Converting models is the art of altering a model from its normal appearance. There are countless ways to convert a model, like using modeling putty to add extra features or swapping bitz and pieces from other models. From simple additions like a few skulls around a hero's base to wild changes like tentacles or mutations, a conversion can really make a model unique and characterful.

For conversion fans, this complete catalog is like finding the fabled Golden City of El Dorado. All the available bitz, plastic sprues, and individual models are shown on page after page. So whether you are looking at finding some thematic metal shoulder pads for your Space Marine army or looking for some severed heads to adorn your Ork Warlord's trophy rack, you've come to the right place.

Explore Ranges

When planning for conversions, don't just look for bitz to use in your own army section. Branch out and try other games entirely. Use Warhammer 40,000 models in your

Warhammer force or Warhammer bitz to help detail your Warhammer 40,000 vehicles. Below are some ideas.

- Check out the range of metal and plastic shields for each of the Warhammer armies.
- Bitz can make for great campaign markers and really bring a map to life!
- Scavenged Ork weapons can be pulled from any army!
- Chaos mutations know no bounds!
- A few models from your favorite opponent's range make for nice prisoners or casualties.
- Try using Empire or Bretonnian banners for Space Marines or Imperial Guard.

Inspiration

When you sit down to start a new painting project, it is often useful to have a reference. What could be better than hundreds of pages of painted miniatures?

With this catalog, you will no longer be subjected to hasty last-minute scrambles to find a painted picture in an old issue of *White Dwarf* or have to go online to scour the Games Workshop web site. In addition to models from the incomparable 'Eavy Metal team, there are tons of pictures of Golden-Demon-winning models, armies from Grand Tournament champions, and a host of variant schemes in the Colors of War sections.



The 2005 Seattle Grand Tournament was chock-full of great figures as you can see here.
Left: Tony DeFilipps converted this great Beastman standard bearer.
Above: Bob Kelley's Ultramarines capture the feel of one of the greatest of all Space Marine Chapters.
Right: Christopher Bell had an interesting take on Undead with his Undead Orcs and Goblins.

THANKS!

The *Complete Games Workshop Catalog and Hobby Reference* is enormous. There is no denying that this project would never have gotten off the ground without the help of many, many people, and we'd like to take this space to thank as many of them as we can.

First off, thanks to the matchless talents of the Games Workshop Citadel Miniatures sculptors and 'Eavy Metal Team painters. These models are not mere "toy soldiers" but instead are tiny works of art that will continue to bring the exciting worlds of Games Workshop to life for so many of us.

Second, thanks to all the fans and hobbyists out there who we have seen at Games Day, Golden Demon painting competitions, Grand Tournaments, Rogue Trader events, and more. Without your skills and enthusiasm, there would be no Games Workshop.

Special thanks go out to all the hobbyists whose work appears in this catalog. These full-color examples of some of the most splendid paint jobs, conversions, and armies on this planet would not have been possible without your work. We have tried to give credit to all the artists who are shown, but with over

600 pages, we're sure we missed a few. Please get in touch with us, and we'll be sure to add your name to the next edition.

And last but not least, thanks to the Games Workshop U.S. staff, especially William Stilwell, Stu Spengler, Nicole Shewchuk, Drew Will, Sean Forbes, and Jeff Cauley, who slaved under the weighty responsibility of showing off all of the Games Workshop products with as much care, sweat, and skill as with which they were originally made and painted. Special mention goes out to those who fell along the way. Thanks again!

All miniatures are supplied unpainted. Models, bitz, and sprues are all shown at their actual size unless otherwise noted. Contents may vary slightly from those shown.



CHAOS CREATURES

The skies grew blacker still until the darkness became an ominous pressure. None knew if the defenses could hold, but when a forking tongue of lightning cracked the skies, the battlefield was illuminated for a brief, but damning moment. Hordes of snarling creatures with bestial manes and wicked axes were revealed. But what stopped the blood from flowing from our hearts was the towering figure rising above the daemonic throngs. We clapped our hands to our faces and covered our eyes and ears as the creature bellowed its own savage answer to the earth-shaking thunderclap.

A Bloodthirster had come, and our doom was sealed.



Jeff Wilson won second place at the 2004 Atlanta Games Day Golden Demon Painting Competition with his Unliving Idol of Khorne.

Chaos Creatures are otherworldly, powerful, and inherently evil. They are also unique in that the majority of models and troop types may be used for both Warhammer 40,000 and Warhammer games.

There are four major powers of Chaos. Khorne, the Blood God, governs the realm of rage and battle. Tzeentch is the Changer of Ways and the Master of magic and the Weave of Time. Nurgle is the Lord of Decay, whose realm is plagues, disease, and pestilence. Slaanesh is the Dark Prince who is neither man nor woman and whose realm is pleasure and decadence.

In Warhammer 40,000

In the far future, the Warp is mankind's greatest hope and also its greatest threat. As the Warp allows for travel between unimaginable distances, entire systems can be crossed in a span of hours, days, or weeks as opposed to the years, decades, and even millennia that conventional travel would require. However, the Warp is rife with peril.

The ebb and flow of the Warp tide is unpredictable and subject to vast storms that affect space, time, and most of all, the sanity of any who dare to enter. The Warp is home to countless horrible creatures and most notably the four Chaos Powers: Khorne, Nurgle, Tzeentch, and Slaanesh.

On the battlefields of the 41st millennium, the Daemons of Chaos may be summoned to aid

the fight of Chaos Space Marines. Greater Daemons may enter the fray by possession, that is, by erupting from the body of a friendly host.

As manifesting physical form into the real world requires a lot of energy and a deep belief in the Chaos power, the Daemons can rarely stay materialized for long and thus are subject to *Instability*. Still, for the short time they may appear on the battlefield, the Daemons are brutal and potentially game-winning units.

As Daemons are summoned onto the battlefield, they can often materialize right where they are needed most. All Daemons, whether Packs, Nurglings, or Beasts have an invulnerable save. However, appearing on the battlefield where they are summoned means that often Daemons are on top of their victims before too many shots may be fired.

Khorne's Bloodletters and Flesh Hounds excel in close combat. Horrors of Tzeentch hurl sorcerous bolts to defeat the foe, and Plaguebearers use their horrible Nurgle's Rot and oozing venom to take out even the toughest of enemy fighters. Slaanesh Daemonettes use their Warp Scream to slow down the enemy and make them ripe for destruction.

In Warhammer

In the world of Warhammer, Daemons exist in the Realm of Chaos and other magically saturated lands. During times of great upheaval, Daemons may also be summoned to the mortal lands to wreak untold havoc.

Daemons may be fielded in several ways in Warhammer. They may be a part of a Chaos army under the command of a mortal or beasts General, be it a Chaos Lord, Exalted Sorcerer, Beast Lord, or Doombull. Alternatively, a player can choose to field an entire army of Daemons led by a Greater Daemon or Daemon Prince.

On the battlefield, all Daemons are a force to be reckoned with. Blocks of Bloodletters or Plaguebearers are capable of taking out the enemy's best elite units in close combat. Flesh Hounds of Khorne are excellent fast flanking troops, and Screamer of Tzeentch and Chaos Furies can fly to hit the enemy

almost anywhere on the battlefield. Horrors of Tzeentch can mass in units and cast devastating spells, while units that get too close can be assailed by accompanying Flamers who cast magical firebolts within 8". Slaanesh Daemonettes produce an aura that distracts and disables the foe.

Elite units, Dragons, Giants, and more will pale before the powers of Greater Daemons. Greater Daemons and Daemon Princes are colossal embodiments of Chaos and leave only destruction and terror in their wake.

The Nature of the Beast

Whether you are building a unit for Warhammer 40,000 or Warhammer, Daemons are both colorful and hard-hitting. By their very nature, Chaos creatures provide a fantastic opportunity for creative modelers and conversion-fans to really go to town. On the following pages, you will find examples of Golden Demon winners and eye-catching Grand Tournament armies. Many of these examples are converted, that is, they have mixed and matched body parts, weapons, tentacles, mutations, and even extra putty to make them unique (and often quite hideous).

Use these examples, as well as all the pictured bitz and pieces, to spark your own imagination and help you come up with your own twisted mutations of Chaos. So what are you waiting for? Grab your hobby knife and get converting!!!

Brian Hotovec won first place at the 2004 Chicago Games Day Golden Demon Painting Competition with Gorthrax, Greater Daemon of Khorne.



About the Chaos Creatures Section

This section contains models that are for use in armies in both Warhammer and Warhammer 40,000. Unless otherwise noted, all of the boxed sets and blister packs in the Chaos Creatures section come packaged with both Warhammer and a Warhammer 40,000 game-appropriate bases where applicable.



Above: Although the Chaos furies are shown on their box cover with square 25mm bases for Warhammer, they come packaged with both those bases and the 25-mm round bases for use in Warhammer 40,000.



GETTING STARTED

Warhammer Armies: Hordes of Chaos has all of the rules for the majority of the Daemons in this section, as well as tips on collecting and fielding a Chaos Daemon army. Warhammer: Storm of Chaos contains new troop types for Chaos and plenty of background information on Archaon's campaign of destruction.

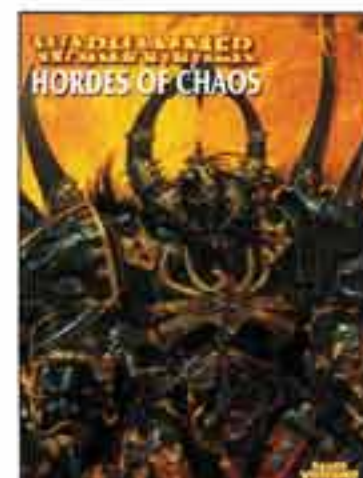

Warhammer Armies: Hordes of Chaos
60030201002



Warhammer Armies: Storm of Chaos
60030201004



GREATER DAEMONS



BLOODTHIRSTER HEAD 1
9947991500511



BLOODTHIRSTER HEAD 1 RIGHT HORN
9947991500510



BLOODTHIRSTER LEGS
9947020106403



BLOODTHIRSTER HEAD 1 LEFT HORN
9947991500512



BLOODTHIRSTER TORSO 1
9947991500512



Bloodthirster, Greater Daemon of Khorne Box (1)
99119915005



BLOODTHIRSTER TABARD
9947020106405



BLOODTHIRSTER AXE
9947020106406



BLOODTHIRSTER WHIP HAND
9947020106407



BLOODTHIRSTER LEFT WING
9947020106408

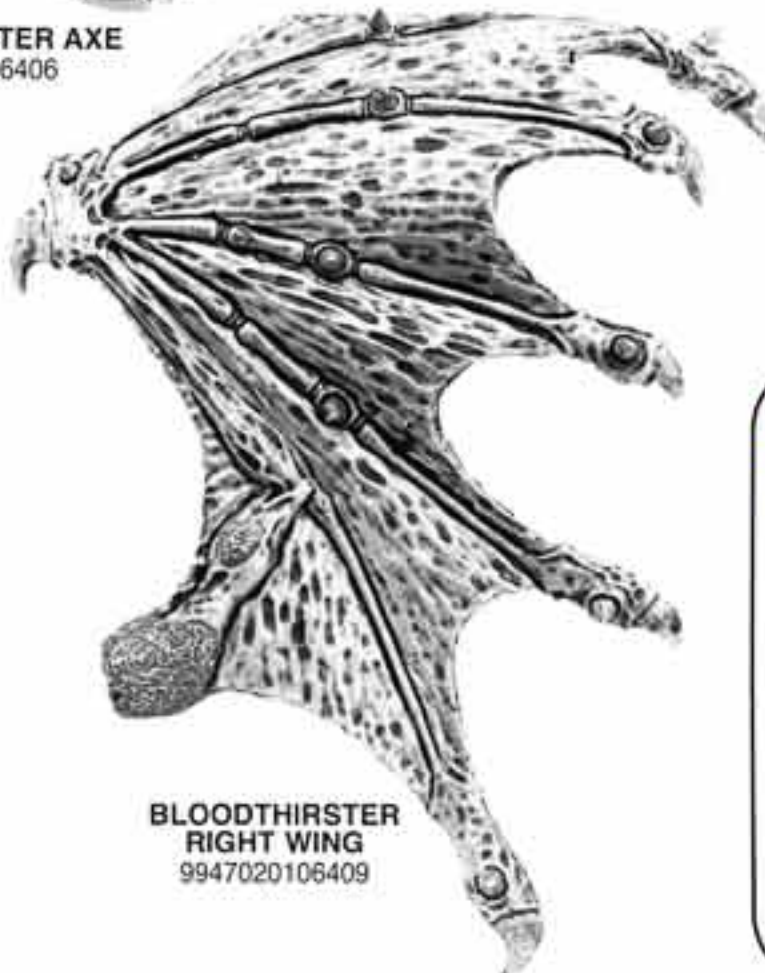

BLOODTHIRSTER RIGHT WING
9947020106409



BLOODTHIRSTER WHIP
9947020106404



These alternate bits for the Bloodthirster are available only via Special Offer.



BLOODTHIRSTER TORSO 2
9947020106402



BLOODTHIRSTER HEAD 2
9947020106401



GREATER DAEMONS



**Great Unclean One,
Greater Daemon of Nurgle Box (1)**
99119915008



GREAT UNCLEAN ONE HEAD
9947991500810



GREAT UNCLEAN ONE UPPER BODY
9947020103101

PAINTING UNCLEAN ONE FLESH

Here, we'll show you a few techniques and tricks you can use to paint the areas of rotting flesh on your Great Unclean One. These techniques are simple to do and, when properly executed, will yield a stunning Greater Daemon.

Undercoat your Greater Daemon with Chaos Black spray and paint any areas of poor coverage with thinned Chaos Black paint. Paint the flesh areas of the Daemon with a basecoat mix of Dark Angels Green and Vomit Brown. Add a little Bleached Bone to the basecoat and highlight the raised areas.



Highlight the Daemon's pustules again after adding more Bleached Bone to the Dark Angels Green and Vomit Brown basecoat mix. Paint the maggots in a 50/50 mix of Bubonic Brown and Bleached Bone. Highlight after adding more Bleached Bone to the mix.



Paint the intestines and gaping flesh with a mix of Bubonic Brown and Chaos Black. Highlight these areas after adding Bleached Bone to the initial paint mix. To finish off, wash these areas with a thin coat of Brown Ink.



Paint the exposed bone areas of the Greater Daemon with a 50/50 mix of Bubonic Brown and Chaos Black. Add Bleached Bone to this mix for a series of successive highlights. Finish off with a final highlight of Bleached Bone. To finish off the rotting flesh areas, apply several glazes of Purple, Green and Brown Inks.



**GREAT UNCLEAN ONE
LEFT LEG**
9947020103105



**GREAT UNCLEAN ONE
LEFT ARM**
9947020103107



**GREAT UNCLEAN ONE
RIGHT LEG**
9947020103106



**GREAT UNCLEAN ONE
LOWER BODY**
9947020103102

The Great Unclean One also comes with two random Nurgling bitz shown later in this section.



These alternate bitz for the Great Unclean One are only available via Special Offer.



**GREAT UNCLEAN ONE HEAD 2
TONGUE TIP**
9947020103111



**GREAT UNCLEAN ONE HEAD 2
TONGUE**
9947020103110



GREAT UNCLEAN ONE HEAD 2
9947020103103



**GREAT UNCLEAN ONE
RIGHT ARM**
9947020103104



**GREAT UNCLEAN ONE
CHAIN & SKULLS**
9947020103109



**GREAT UNCLEAN ONE
LEFT HAND & CHAIN**
9947020103108



GREATER DAEMONS



PAINTING SLAANESH DAEMONS

Daemons of Slaanesh have a pale, almost pastel hue to their skin. We have detailed a few of the techniques we used to paint our Greater Daemon of Slaanesh below.

Undercoat the Greater Daemon with a thin layer of Chaos Black. Paint the skin with a basecoat of Dwarf Flesh. Add increasing amounts of Elf Flesh to Dwarf Flesh and paint a series of successive highlights. Finish with Elf Flesh on its own.



Add Skull White to Elf Flesh and paint another highlight. Finally, apply very delicate highlights of Skull White to the model.

To add some definition to your Daemon, apply a thin layer of Blue Ink to some of the deeper recesses of the model.



Paint a basecoat of four parts Liche Purple to one part Chaos Black on the claws and horns. Highlight first with Liche Purple and then with successive

layers of Liche Purple with Skull White added. Wash these sections with Purple Ink.

Paint the tongue with a basecoat of Shadow Grey. Add in a small quantity of Dwarf Flesh for the highlights on the tongue.



Paint the Daemon's black endoskeleton, talons, and straps with a basecoat of Chaos Black and then highlight with Codex Grey.

Paint the gold areas with a basecoat of Dwarf Bronze. Highlight with Shining Gold and then add Mithril Silver to the Shining Gold for edging highlights.

If you have a steady hand, you might want to try painting some tattoos on the model in Chaos Black paint like the one shown on the right.



Keeper of Secrets, Greater Daemon of Slaanesh Box (1)
99119915011



KEEPER OF SECRETS CLAW 1
9947020110809



KEEPER OF SECRETS CLAW 2
9947020110810



KEEPER OF SECRETS HEAD 1 RIGHT HORNS
9947991501113



KEEPER OF SECRETS HEAD 1
9947991501114



KEEPER OF SECRETS HEAD 1 LEFT HORNS
9947991501115



KEEPER OF SECRETS LEFT ARM
9947020110807



KEEPER OF SECRETS RIGHT LEG
9947020110804



KEEPER OF SECRETS LEFT LEG
9947020110803



KEEPER OF SECRETS BODY
9947020110802



KEEPER OF SECRETS SWORD ARM
9947020110808



KEEPER OF SECRETS LOINCLOTH 2
9947991501111



KEEPER OF SECRETS LOINCLOTH 3
9947991501112



These alternate bits for the Keeper of Secrets are only available via Special Offer.



KEEPER OF SECRETS LOINCLOTH
9947020110805



KEEPER OF SECRETS TAIL PIECE
9947020110806



KEEPER OF SECRETS HEAD 2
9947020110801



GREATER DAEMONS



LORD OF CHANGE
RIGHT WING
9947020103614



LORD OF CHANGE
LEFT WING
9947020103613



LORD OF CHANGE
HEAD 1
9947991501318

Lord of Change, Greater Daemon of Tzeentch Box (1)
99119915013



LORD OF CHANGE
CLAWS
9947020103612



LORD OF
CHANGE BODY
9947020103601



LORD OF CHANGE
NECK A
9947991501317



These alternate bitz for the Lord of Change are available only via Special Offer.



LORD OF CHANGE
HEAD 2
9947020103603



LORD OF CHANGE
STAFF TOP 2
9947020103604



LORD OF CHANGE
NECK 2
9947020103602



LORD OF CHANGE
STAFF 2
9947020103608



LORD OF CHANGE
STAFF 1
9947991501315



LORD OF CHANGE
STAFF TOP A
9947991501316



LORD OF CHANGE
SLEEVE
9947020103607



LORD OF CHANGE
RIGHT ARM
9947020103606



LORD OF CHANGE
FRONT TABARD
9947020103609



LORD OF CHANGE
REAR TABARD
9947020103610



LORD OF CHANGE
LEFT LEG
9947020103611



LORD OF CHANGE
RIGHT LEG
9947020103605



GREATER DAEMONS

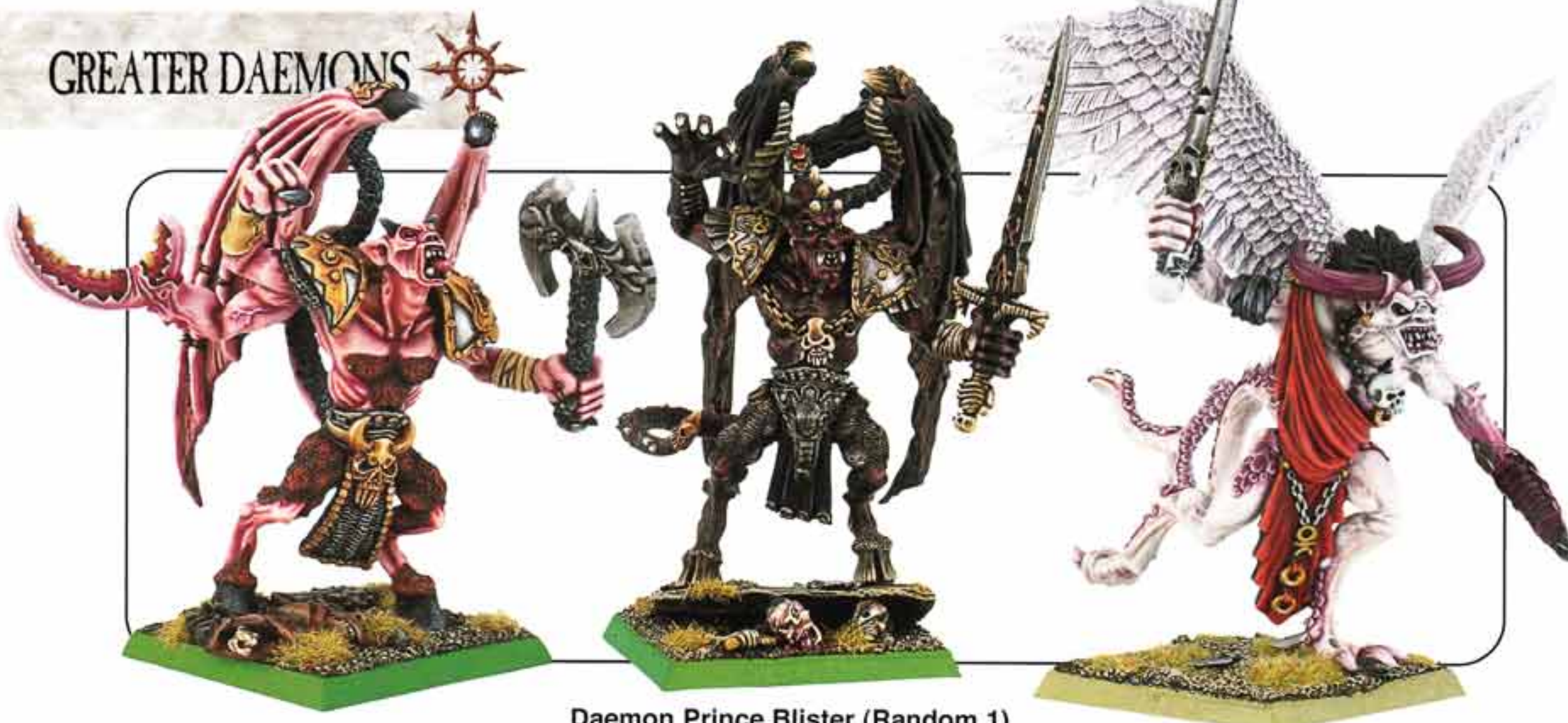

Daemon Prince Blister (Random 1)
99060201048

The Daemon Prince Blister contains enough bitz to build one of three types of Daemon Prince. The two models shown above on the left are examples of what can be built from the bitz shown on this page. The model on the right is the one that can be built from the bitz on the top of the opposite page.



DAEMON PRINCE HEAD 1
9947020104805



DAEMON PRINCE HEAD 1 HAIR
9947020104806



DAEMON PRINCE HEAD 2
9947020104807



DAEMON PRINCE RIGHT ARM 1
9947020104812



DAEMON PRINCE RIGHT ARM 2
9947020104813



DAEMON PRINCE LEFT ARM 1
9947020104808



DAEMON PRINCE LEFT ARM 2
9947020104809



DAEMON PRINCE BODY 1
9947020104803



DAEMON PRINCE BODY 2
9947020104804



DAEMON PRINCE TAIL 2
9947020104815



DAEMON PRINCE TAIL 1
9947020104814



DAEMON PRINCE AXE
9947020104810



DAEMON PRINCE LEGS 1
9947020104801



DAEMON PRINCE LEGS 2
9947020104802



DAEMON PRINCE SWORD
9947020104811



DAEMON PRINCE RIGHT WING
9947020104816



DAEMON PRINCE LEFT WING
9947020104817



DAEMON PRINCE
AZAZEL HEAD
9947020107801



DAEMON PRINCE
AZAZEL BODY
9947020107802



DAEMON PRINCE
AZAZEL LEFT LEG
9947020107803



DAEMON
PRINCE AZAZEL
RIGHT LEG
9947020107804



GREATER DAEMONS



DAEMON PRINCE AZAZEL RIGHT WING
9947020107808



DAEMON
PRINCE AZAZEL
SWORD
9947020107805



DAEMON PRINCE
AZAZEL CLAW
9947020107806



DAEMON PRINCE AZAZEL TAIL
9947020107807



DAEMON PRINCE AZAZEL LEFT WING
9947020107807



LESSER DAEMONS

Chaos Furies Box (10)
99119915012



CHAOS FURY 1
9947991501201



CHAOS FURY 2
9947991501202



CHAOS FURY 3
9947991501203



CHAOS FURY 4
9947991501204



CHAOS FURY
RIGHT WING
9947991501206



CHAOS FURY
LEFT WING
9947991501205



LESSER DAEMONS



BLOODLETTER AXE 1
9947991500302



BLOODLETTER AXE 4
9947991500308



BLOODLETTER AXE 2
9947991500304



BLOODLETTER AXE 5
9947991500310



BLOODLETTER AXE 3
9947991500306



BLOODLETTER AXE 6
9947991500312

**Bloodletters of
Khorne Box (10)**
99119915003

**Bloodletter
Champion Blister (1)**
99069915006

**Bloodletter Musician &
Standard Blister (2)**
99069915004

The weapons and bodies for the Bloodletters are not completely interchangeable. Bloodletter Bodies 1 and 4 go with Bloodletter Axes 1 and 4, Bloodletter Bodies 2 and 5 go with Bloodletter Axes 2 and 5, Bloodletter Bodies 3 and 6 go with Bloodletter Axes 3 and 6.



**BLOODLETTER
BODY 1**
9947991500301



**BLOODLETTER
BODY 4**
9947991500307



**BLOODLETTER
BODY 2**
9947991500303



**BLOODLETTER
BODY 5**
9947991500309



**BLOODLETTER
BODY 3**
9947991500305



**BLOODLETTER
BODY 6**
9947991500311



**BLOODLETTER
CHAMPION BODY**
9947991500601



**BLOODLETTER
CHAMPION AXE**
9947991500602



**BLOODLETTER STANDARD
BEARER BODY**
9947991500403



**BLOODLETTER
STANDARD**
9947991500404



**BLOODLETTER
MUSICIAN BODY**
9947991500401



**BLOODLETTER
MUSICIAN AXE**
9947991500402



LESSER DAEMONS



Flesh Hounds of Khorne Box (5)
99119915002



FLESH HOUNDS HEAD 1
9947991500209



FLESH HOUNDS HEAD 2
9947991500210



FLESH HOUNDS HEAD 3
9947991500211



FLESH HOUNDS HEAD 4
9947991500212



FLESH HOUNDS LEGS 1
9947991500202



FLESH HOUNDS LEGS 2
9947991500204



FLESH HOUNDS LEGS 3
9947991500206



FLESH HOUNDS LEGS 4
9947991500208



FLESH HOUNDS BODY 1
9947991500201



FLESH HOUNDS BODY 2
9947991500203



FLESH HOUNDS BODY 3
9947991500205



FLESH HOUNDS BODY 4
9947991500207

The legs and bodies for the Flesh Hounds shown above are not interchangeable. Legs 1 go with Body 1, and so on.





LESSER DAEMONS



Daemonettes of Slaanesh Box (10)
99119915010



DAEMONETTE 1
9947991501001

DAEMONETTE 2
9947991501002

DAEMONETTE 3
9947991501003

DAEMONETTE 4
9947991501007

DAEMONETTE 7
9947991501010

DAEMONETTE 6
9947991501009

DAEMONETTE 5
9947991501008



DAEMONETTE ARM 1
9947991501004



DAEMONETTE ARM 2
9947991501005



DAEMONETTE ARM 3
9947991501006



DAEMONETTE ARM 4
9947991501011



DAEMONETTE ARM 5
9947991501012



DAEMONETTE ARM 6
9947991501013





LESSER DAEMONS



Daemonettes on Steeds of Slaanesh Blister (Random 1)
99069915018

The Daemonettes on Steeds of Slaanesh blister contains one complete set of body and legs as shown together below. These parts are not interchangeable.



MOUNTED DAEMONETTE SPRUE 1
9947991501802

MOUNTED DAEMONETTE 1
9947991501801



MOUNTED DAEMONETTE 2
9947991501803

MOUNTED DAEMONETTE SPRUE 2
9947991501804



MOUNTED DAEMONETTE SPRUE 3
9947991501806

MOUNTED DAEMONETTE 3
9947991501805



MOUNTED DAEMONETTE 4
9947991501807

MOUNTED DAEMONETTE TAIL 4
9947991501808





LESSER DAEMONS



Flamers of Tzeentch Blister (Random 2)
99069915016



FLAMER BODY 1
9947991501601



FLAMER BODY 2
9947991501602



FLAMER BODY 3
9947991501603



FLAMER BODY 4
9947991501604



FLAMER ARMS 1
9947991501605



FLAMER ARMS 2
9947991501606



FLAMER ARMS 3
9947991501607



FLAMER ARMS 4
9947991501608



*The bodies and tails for the Screamers are not interchangeable.
Tail 1 is designed to go with Body 1 and so on.*



Screamers of Tzeentch Box (5)
99119915015



SCREAMER 1
9947991501501



SCREAMER 1 TAIL
9947991501502



SCREAMER 2
9947991501503



SCREAMER 2 TAIL
9947991501504



SCREAMER 3
9947991501505



SCREAMER 3 TAIL
9947991501506

All miniatures are supplied unpainted. Models, bits, and spines are all shown actual size unless otherwise noted. Contents may vary slightly from those shown.



LESSER DAEMONS



Horrors of Tzeentch Box (10)
99119915014



HORROR 1
9947991501401



HORROR 2
9947991501402



HORROR 3
9947991501403



HORROR 4
9947991501404



HORROR 5
9947991501408



HORROR 6
9947991501409



HORROR 7
9947991501410



HORROR 8
9947991501411



**HORROR ARM
SPRUE 1**
9947991501405



**HORROR ARM
SPRUE 2**
9947991501406



**HORROR ARM
SPRUE 3**
9947991501407



**HORROR ARM
SPRUE 4**
9947991501412



**HORROR ARM
SPRUE 5**
9947991501413



**HORROR ARM
SPRUE 6**
9947991501414

PAINTING TZEENTCH HORRORS

Crackling with magical energy, the Daemons of Tzeentch are resplendent in bright primary colors.

To get a nice, bright final color on your Horrors of Tzeentch, start with a Skull White undercoat. Make sure your coverage is complete.

Start by painting a basecoat of Enchanted Blue. Once this coat dries, wash the model in Blue Ink.

Highlight the skin with Enchanted Blue and then again with Hawk Turquoise.

Blend up a 50/50 mix of Hawk Turquoise and Skull White and highlight the raised areas of the model.



Paint the Horror's nails with Skull White.



Paint the mouth and eyes with Chaos Black. Basecoat the gums, eyes, and tongue in Warlock Purple. Pick out the details with Tentacle Pink and add an extra Skull White highlight to the tongue. Add spots to the tongue by dipping your brush in Magenta Ink and dabbing the tip onto the tongue.



Finish off your Horror by covering the base. Cover the base with white glue and dip it into a container of sand. Paint the sand with Black Ink and then drybrush it with Bleached Bone. Dab a bit of white glue in places on the base and dip it into a container of static grass. Paint the edge of the base in Goblin Green. If you like, you can paint areas of the base in Magenta or Blue Ink to represent dripping magical energy.



LESSER DAEMONS



Group shot shown at approximately 65% actual size.

PAINTING PLAGUEBEARERS

Plaguebearers are rotten with disease and dirty with decay. Their colors are normally muted and muddy. The technique described below allows you to paint 5 or 10 Plaguebearers quickly and at the same time.

Undercoat the Plaguebearer with Skull White and then basecoat it with Bleached Bone.

Apply Black Ink to the entire surface of the model. Once dry, wash the Plaguebearer with Dark Green Ink.

Highlight the model by painting Bleached Bone on the raised and flat areas. Take a little extra time on the face and make sure you pick out the cheek bones and nose.

Next, apply Brown and Chestnut Inks to select parts of the model, generally the darker recessed areas. Streak some ink across the belly to make it look dirty and diseased.

Paint the open wounds and sores with Snakebite Leather and then wash these areas with Red Ink. Don't worry if some of the Ink overruns, as it will only add to the wounded, diseased look of the model.

Highlight the facial features, outer flaps of broken skin, and pustules with Bleached Bone followed by Skull White.

Paint the single eye with Blood Red and then Skull White. Leave red

around the edge of the eye. To finish off the Daemon, dot the eye with a Chaos Black pupil and wash the sword with Brown Ink.



Plaguebearers of Nurgle Box (10)
99119915007



PLAGUEBEARER 1
9947991500701

PLAGUEBEARER 6
9947991500706

PLAGUEBEARER 3
9947991500703

PLAGUEBEARER 8
9947991500708



PLAGUEBEARER 5
9947991500705

PLAGUEBEARER 2
9947991500702

PLAGUEBEARER 7
9947991500707

PLAGUEBEARER 4
9947991500704



Nurplings Blister (2 Bases)
99069915019



NURGLING 1
9947991500901

NURGLING 2
9947991500902



NURGLING 3
9947991500903



NURGLING 5
9947991500905



NURGLING 8
9947991500908



NURGLING 4
9947991500904



NURGLING 6
9947991500906



NURGLING 7
9947991500907

All miniature sets are supplied unpainted. Models, bits, and sprues are all shown at full size unless otherwise noted. Contents may vary slightly from those shown.



Warhounds of Chaos Box (10)
99119915017



LESSER DAEMONS

The bodies, heads, and legs for the Warhounds are not interchangeable. Leg Sprue 1 is designed to go with Body 1 and so on.



CHAOS WARHOUND HEAD 4
9947991501709



CHAOS WARHOUND LEGS SPRUE 1
9947991501702



CHAOS WARHOUND LEGS SPRUE 2
9947991501704



CHAOS WARHOUND LEGS SPRUE 3
9947991501706



CHAOS WARHOUND LEGS SPRUE 4
9947991501708



CHAOS WARHOUND BODY 1
9947991501701



CHAOS WARHOUND BODY 2
9947991501703



CHAOS WARHOUND BODY 3
9947991501705



CHAOS WARHOUND BODY 4
9947991501707



Spawn of Chaos Box (1)
99119915001



SPAWN OF CHAOS BODY
9947991500103



SPAWN OF CHAOS SPRUE 1
9947991500106



SPAWN OF CHAOS SPRUE 2
9947991500107



SPAWN OF CHAOS HEAD
9947991500101



SPAWN OF CHAOS LEFT ARM
9947991500104



SPAWN OF CHAOS RIGHT ARM
9947991500102



SPAWN OF CHAOS FEET
9947991500105



COLORS OF WAR



KEY

■ Top Box(es): Basecoat Colors & Ink Washes

■ Bottom Box(es): Highlights

■ Mixed Colors



*Liche Purple & Warlock Purple
Warlock Purple & Skull White*



*Scaly Green, Codex Grey
Rotting Flesh, Scab Red*



*Regal Blue, Ultramarines Blue
Ultramarines Blue & Skull White*



*Bleached Bone, Bestial Brown
Skull White, Kommando Khaki*



*Enchanted Blue, Hawk Turquoise
Ice Blue, Goblin Green*



*Scorched Brown & Snakebite Leather
Kommando Khaki & Bleached Bone*



*Catachan Green & Camo Green
Camo Green & Rotting Flesh*



*Dark Flesh & Tanned Flesh
Dwarf Flesh & Elf Flesh*



*Chaos Black & Scab Red
Scab Red & Blood Red*



*Red Gore & Blood Red
Blood Red & Fiery Orange*



*Dwarf Flesh, Chaos Black
Skull White, Enchanted Blue*



*Dwarf Flesh, Scab Red
Skull White, Blood Red*

*Jeff Freeman won third place
at the 2004 Atlanta Games
Day Golden Demon Painting
Competition with his
Bloodthirster.*



SHOWCASE



Above: James Ramsey's Slaanesh Daemonettes won third place at the 2004 Baltimore Games Day Golden Demon Painting Competition.



Above: James Ramsey won second place at the 2004 Baltimore Games Day Golden Demon Painting Competition with his Daemonette Standard Bearer.



Above: Michael J. Summers won third place at the 2004 LA Games Day Golden Demon Painting Competition with his Daemon Prince.



Right: Matt Lewandowski's Nurgle Daemon Prince won third place at the 2004 Baltimore Games Day Golden Demon Painting Competition.



WARHAMMER
40,000



WARHAMMER 40,000

Bring It onto Your Tabletop

Warhammer 40,000 is the game that allows two or more players to command the forces of the Imperium of Mankind or its enemies on the tabletop. Using fantastically detailed models for soldiers, futuristic tanks, aliens, and more, players move, shoot, and try to outmaneuver each other on a table-turned-battlefield. Each player controls a whole army. Good tactics win games, while poor ones will get your forces wiped off the gaming table.

More Than a Game

In addition to being a competitive game, Warhammer 40,000 is an entire hobby. Players can build armies, paint models, create new terrain, devise scenarios or special missions to play, and get involved in an ongoing league or campaign – as many challenges as a gamer could want.

Some players get involved in many different aspects of the Hobby, while some settle on a few or even just one particular part. The following pages are all about getting started with the game and building your army.

All Levels of Gaming

The Warhammer 40,000 rules allow great scope for gaming. Games can range in length from quick half hour skirmishes with a dozen or so models per side to massive battles between dozens of players – each with his own sizeable armies. The objectives of each game can be as simple as “wipe out the other side” to complicated missions seeking to capture a powerful artifact or reach a certain portion of the battlefield (perhaps to close down a teleporter).

Some players build large and official armies for play in tournaments, large gatherings of like-minded competitors. The gaming lasts for hours or even whole weekends before a winner is declared. Other gamers quite gleefully (and unofficially) scratch-build their own battle stations, massive tanks, or mutated monsters to make their games even more varied. Still others link their games to form a large campaign, where each battle affects the next.

There is no right or wrong way to play, and many gamers constantly find new favorite ways to play to supplement traditional gaming. It's a big universe out there!

So Many Choices

First off, it is important that we say there is no right or wrong way to choose an army. There is nothing wrong with starting to collect an army and then switching to another because it suits your style better. Just remember, though, the more times you switch armies, the further you'll be from having a fighting force to play with.

Take a look at the following advice and mull it over. Perhaps we can get you on the right course as quickly as possible.

Getting Started

Some lucky players know which army they want to collect immediately. Perhaps they have seen some games in action or spoken with an experienced friend. Others are less sure and may have boiled it down to a few choices but still don't really know. This page and the next can help you reach a decision.

To make your best decision, the first thing to do is to amass all the information you can about the armies that you find appealing. This very catalog is an excellent aid. There may be a lot of criteria for players choosing their armies, but here are some of the ones we've encountered most often: style of play, background, and the miniatures. Each of these topics deserves closer inspection.

Style of Play

Each army in the Warhammer 40,000 game is different and will be better at different things on the tabletop. The important part here is for players to try to imagine the kind of play they'd like best. Do you see yourself as an aggressive, risk-taking commander who is looking to bring the fight to the enemy? Or does a defensive stand sound better? Would you rather lay down a hail of fire from long-range, or do you want superior numbers to swamp the foe? It is possible to achieve some or even all of these tactics with the same army, but every force has strengths and weak points.

For example, let us consider a Tau army. The Tau have some of the best and most advanced weaponry in the Warhammer 40,000 game. They can strike hard from long range. Where Tau fall short is in close quarters combat. There are upgrades, troop choices (like Kroot), and more that can compensate for this lack of hand-to-

hand skill, but even with these things in place, a Tau army is far better off when keeping the foe at range.

In this catalog, players can find out more about how each army plays by reading the Fighting Style sections for each force.

Background

One of the best parts of the Warhammer 40,000 game is the rich background. Each army has its own history, home world, and goals. A lot of players find inspiration for collecting an army in its background.

For example, the Tyranids are an alien race that has a single Hive Mind consciousness. All the swarms of creatures are coordinated as if a single mind controlled them! Tyranids drift through space looking for life forms to consume for the Hive. Most of the troop types are mindless engines of destruction that can be driven to destroy all they encounter.

A player looking for a small army with lots of individuality, a noble history, and a valiant ethos would do well to steer clear of the Tyranids! Each army in this catalog begins with some background information.

Miniatures

Many players choose armies based strictly on the look of the model range. Since collecting and painting are such a large part of the Warhammer 40,000 Hobby, choosing a force based on looks is a sensible option. After all, the more you like and enjoy the models, the more you'll have fun in the collecting, painting, and modeling aspects of the Hobby.

This catalog is ideal in that such minded players can ogle the entire available range of models for each army.

Taking the Next Step

The next step, once you've found an army or two that really capture your interest, is to find out more. The Games Workshop web site is also ideal for this sort of research, and you'll find information about every army.

Finding and talking to a local gaming group is always a great idea. After all, the members may be some of the opponents you'll be squaring off against with your new army in the future. Ask around to find out the times when players meet at your local Rogue Trader Independent Retailer or Games Workshop Hobby Center.



The Essentials – The Codex

Once you've decided on an army, the Codex for that army is the next logical step. Each Codex goes into detail about one particular army, its rules, and background and enables players to build game-legal armies for play.

Each Codex contains a complete army list along with descriptions and rules for every troop and vehicle as well as every weapon and piece of battle gear available to the force. Additional background and history are included, as are the profiles for some special characters and all the special rules you'll need to know about your army of choice.

Collecting Models

If you are anything like us, you often gravitate toward the most eye-catching models in the range first, which is completely understandable. However, if you end up with an army that has only commanders and no troops, playing a standard game can become a problem. It makes sense to balance your force as you collect it.

Most Warhammer 40,000 scenarios are played with the Standard Mission template (shown at right). This is an excellent place to start, as it lists maximums for different types of squads as well as the minimum requirements. These minimums – an HQ choice and two Troops choices – make an excellent starting force.

In this catalog, in the Collecting an Army sections of each chapter, we make a few suggestions about how to begin collecting each army.

As you continue to collect models and expand your force, you'll want to include extra choices in your force, like four or five options for Heavy Support even though only three are allowed in Standard Missions. Why? Having a range of models to choose from allows you to switch your army or gear up to take on specific opponents. The ability to field three tanks or two Devastator Squads is a nice option against tough foes who aren't expecting such a plan. Similarly, having a lot of Fast Attack choices to make a highly maneuverable army will surprise opponents who are expecting a slow or defensive force.



Warhammer 40,000 is full of armies that are fun to play, model, and paint. From the technologically advanced and idealistic Tau to the implacable pinnacle of genetic modification of the Tyranids, you can find an army for you!

Each Codex arranges its army into the following sections: HQ, Elites, Troops, Fast Attack, and Heavy Support. This catalog is similarly organized.



HQ. HQ is short for Headquarters and contains heroes, officers, advisors, and other specialists that lead the army.



Elites. Elites are the best trained or most ferocious warriors in the army. They often have access to the best weapons and armor.



Troops. All armies contain a high number of rank-and-file soldiers. Often, these warriors are flexible, if not spectacular, in all aspects of battle.



Fast Attack. Speed is vital in warfare, and these squads or vehicles are ideal at grabbing objectives, scouting, or disrupting the foe.



Heavy Support. The awesome firepower of battle tanks or war machines can pound the enemy to smithereens!

Standard Missions

The Standard Mission Force Organization Chart provides a good guide for choosing an army. To begin with, you will need at least one HQ unit and two Troop units (dark-shaded boxes indicate units that must be taken for the mission). Beyond these mandatory choices, you have some flexibility in choosing the remainder of your force from the following: up to 1 HQ, 0-3 additional Elites, 0-4 additional Troops, 0-3 additional Fast Attack, and/or 0-3 additional Heavy Support.

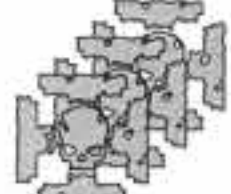

COMPULSORY

- 1 HQ
- 2 Troops

OPTIONAL

- 1 HQ
- 4 Troops
- 3 Elites
- 3 Fast Attack
- 3 Heavy Support

All miniatures are supplied unpainted. Models, bats, and spaces are all shown actual size unless otherwise noted. Contents may vary slightly from those shown.

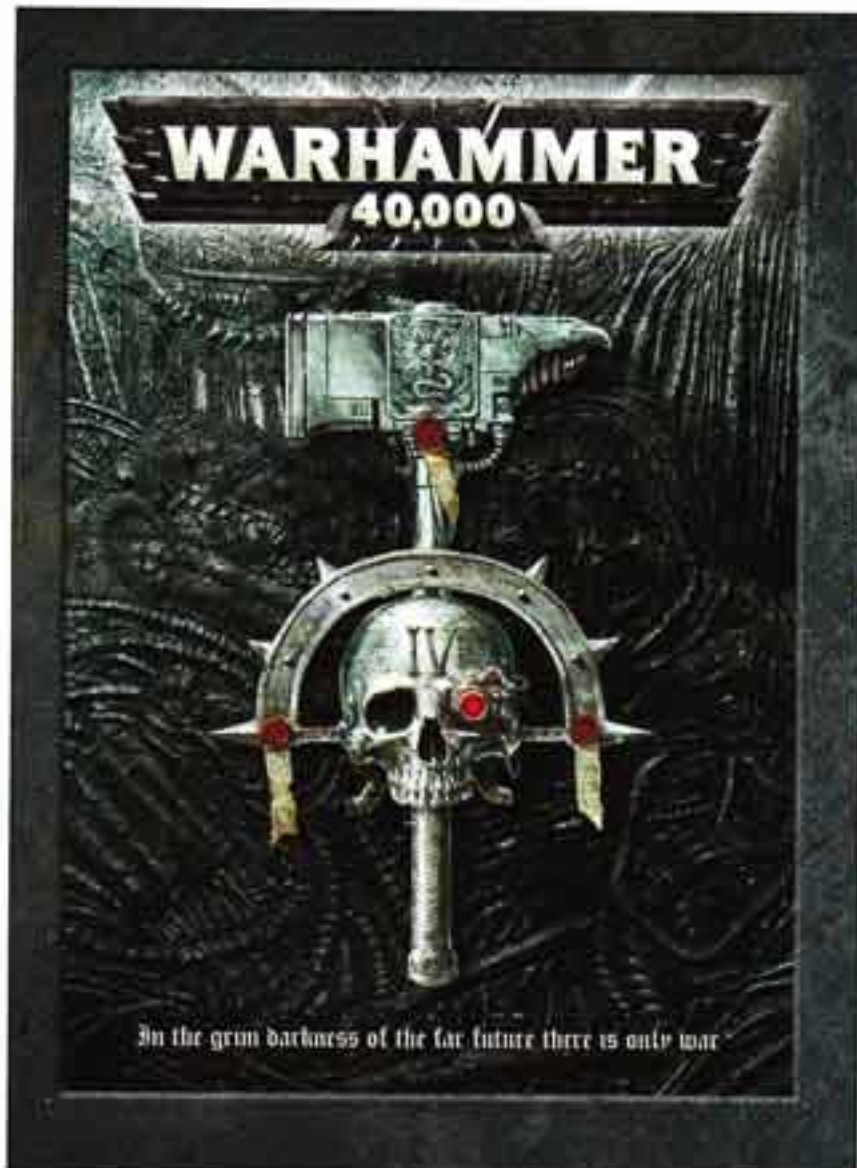

Warhammer 40,000 Rulebook
60040199011



Left: In the nightmare future of the 41st millennium, Mankind teeters upon the brink of extinction! The Warhammer 40,000 rulebook provides all the rules as well as a ton of great hobby support. The rulebook also includes a comprehensive history, campaign rules, and loads of scenarios – all in a handsome hardback!

Below: Battle for Macragge is a great way to get started with Warhammer 40,000. Everything you need to get started right away is included. If you are looking to learn how to play Warhammer 40,000, this set is for you!



WEAPON TEMPLATES
(SHOWN 20% ACTUAL SIZE)
99220199009



Battle for Macragge Box (contains rules, dice, templates, range rulers, 16 Tyranids, 10 Space Marines, 1 Lt. Varras, & crashed Aquila Lander terrain)
60010199002



CHAOS SPACE MARINES

We fight the long war, not for vain notions of duty or honor, but for a far purer purpose: hatred. At the height of our glory, we were betrayed and cast out by our own kin. Guilliman, Dorn, Sanguinius – these are names I curse. Horus, Perturabo, Angron – these are names I revere, names I would follow to the very end. It is that hatred that has sustained me through the long millennia. I tend it with bitterness. I nurture it with the deaths of my former brothers. I know that when the end is upon us and Horus is returned, then the false Emperor shall be cast down from his sepulchral Golden Throne, and we shall take our rightful place at the side of Horus, the true Emperor of Mankind.

Ferrous Ironclaw – Warsmith of the Iron Warriors Second Grand Company

At the very birth of the Imperium of Man, fully half of the Emperor's most trusted Space Marine Legions turned against him in a bitter civil war. Brother fought brother, and Mankind stood upon the very brink of extinction. Ten thousand years after their defeat, those same traitors, intent upon nothing less than the utter destruction of the Imperium and the death of its weakling Emperor, still launch their Black Crusades out of the Eye of Terror.

Fighting Style

Chaos Space Marines are a versatile force. You can specialize your army such that you have a lot of fast troops, heavy assault, close combat experts, or even troops like Daemons. With power and Terminator armor, most Chaos armies can absorb a lot of punishment. As such, almost any fighting style is possible with this army. However, because of their high points cost, Chaos armies tend to be small in number. Thus, wars of attrition are not advisable.

Collecting a Chaos Army

The Warhammer 40,000 Chaos Space Marine army has one of the widest selections of different troop types in the entire game. Not only do Chaos Commanders get to pick from the heretical forces of the Chaos Space Marine Legions, but there are tons of specialty troops including Chaos Space Marine Bikers, high-flying Raptors, and the living weapons of the Chaos Obliterators. There are also cults within the Chaos Space Marine Army dedicated to the four major powers of Chaos (Khorne, Tzeentch, Nurgle, and Slaanesh) like the blood-soaked Khorne Berzerkers and the ear-shattering Noise Marines. Each one specializes in a particular form of destruction. In addition, Chaos Space Marines can summon help from the Warp itself by enlisting the aid of Daemon Packs and Daemon Beasts to crush their opponents' bodies and souls. As if that weren't enough, there is a wide array of vehicles including the Chaos Dreadnought, whose only purpose is to blast opposing forces to bits. Above all, Chaos Space Marine armies are about variety (and evil), and there are plenty of models available to suit even the most warped Chaos Space Marine Lord.



Above: Will Hahn won second place with his Nurgle Daemon Prince at the 2004 LA Golden Demon painting competition.

Below: Terrence Peterson's Emperor's Children Dreadnought won second place in the Warhammer 40,000 Vehicle or Squadron category at the 2004 Chicago Golden Demon painting competition.



Above: Tim Holly's Nurgle Mutants won first place in the Open category at the 2004 LA Golden Demon painting competition.

All miniatures are supplied unpainted. Models, base, and sprays are all shown actual size unless otherwise noted. Contents may vary slightly from those shown.



Chaos Space Marines Battle Force Box 99120102009

- 12 Khorne Berzerkers
- 8 Chaos Space Marines
- 3 Chaos Bikers
- 1 Chaos Rhino



GETTING STARTED



Codex: Chaos Space Marines
60030102003

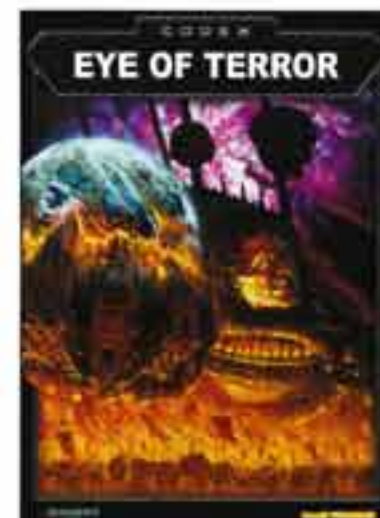

Codex: Eye Of Terror
60030199007



Chaos Space Marines Mega Force Box – 99120102014

- 8 Khorne Berzerkers
- 12 Chaos Space Marines
- 3 Chaos Bikers
- 1 Chaos Rhino & 1 Chaos Defiler



The 80-page Codex: Chaos Space Marines contains all the rules that you'll need to battle the resistance of the whims of the Dark Gods. Inside, you will find a complete army list that can be customized depending on which evil patron(s) your warriors will follow. In addition, there is extensive background info, a 16-page hobby section, and rules for fielding special characters in your games of 40K.

This 48-page rulebook contains background information on "The Eye of Terror" campaign including four variant army lists and lots of great ideas for challenging games of Warhammer 40,000.

HQ



Chaos Space Marine Lord Blister (1)
99060102068



CHAOS LORD SPRUE
9947010206802



CHAOS LORD BODY 2
9947010206801



CHAOS LORD BACKPACK 2
9947010206803





HQ

SCENIC BASES FOR CHARACTERS

The base can be as important as the model. Here are some great base ideas for your character such as Abaddon, Ahriman, Cypher, Typhus, and any other large-base models.

BASES FOR TZEENTCH/CHAOS UNDIVIDED CHARACTERS



Cut Archaon's base to fit. Use Ork hair for flames and putty to fill in any gaps.

BASES FOR NURGLE CHARACTERS



Create maggots and torn, pustular flesh from putty and texture the base with sand.

BASES FOR KHORNE CHARACTERS



Use skulls clipped from the Chaos vehicle accessory sprue. Arrange the skulls around the model's feet.

BASES FOR SLAANESH CHARACTERS



Use Skaven tails and putty to make the fleshy bits. Glue sand over top of the putty for texture.



Chaos Space Marine Sorcerer Blister (Random 1)
99060102013



CHAOS SORCERER BODY 1
9947010201301



CHAOS SORCERER BODY 2
9947010201304



CHAOS SORCERER BODY 3
9947010201307



CHAOS SORCERER BOLT PISTOL ARM 1
9947010201303



CHAOS SORCERER BOLT PISTOL ARM 2
9947010201305



CHAOS SORCERER PLASMA PISTOL
9947010201308



CHAOS SORCERER BACKPACK 1
9947010201302



CHAOS SORCERER BACKPACK 2
9947010201306

All miniatures are supplied unpainted. Models, bits, and sprues are all shown actual size unless otherwise noted. Contents may vary slightly from those shown.



**Night Lord Hero
Blister (1)**
99060102082



**NIGHT LORD
HERO BODY**
9947010208202



**NIGHT LORD HERO
COMBI BOLTER ARM**
9947010208203



**NIGHT LORD HERO
POWER FIST**
9947010208201



**NIGHT LORD HERO
BACKPACK**
9947010208204



**NIGHT LORD
HERO WINGS**
9947010208205



**Emperor's Children
Lord Blister (1)**
99060102064



**EMPEROR'S CHILDREN
LORD BODY**
9947010206401



**EMPEROR'S CHILDREN
LORD DOOMSIREN**
9947010206402



**EMPEROR'S CHILDREN
LORD PISTOL ARM**
9947010206404



**EMPEROR'S CHILDREN
LORD SWORD ARM**
9947010206403



**IRON WARRIORS
WARSMITH CLAW**
994701206606



**IRON WARRIORS
WARSMITH BACKPACK**
994701206602



**IRON WARRIORS
WARSMITH ROBOTIC ARM**
994701206605



**Iron Warrior
Warsmith Blister (1)**
99060102066



**IRON WARRIORS
WARSMITH BODY**
994701206601



**IRON WARRIORS
WARSMITH COMBI-WEAPON**
994701206604



**IRON WARRIORS
WARSMITH BACKPACK CLAW**
994701206603



HQ



Chaos Space Marine Icon Bearer Blister (Random 1)
99060102051



CHAOS MARINE
ICON BEARER BODY
9947010202401



PLAGUE MARINE
ICON BEARER BODY
9947010201901



CHAOS SPACE
MARINE ARM
9947010202702



CHAOS MARINE
ICON BEARER ICON
9947010202402



CHAOS WARP
BANNER ICON
9947010202406



CHAOS BLASTED
STANDARD ICON
9947010202404



KHORNE ICON
9947010201802



PLAGUE MARINE ICON
9947010201902



CHAOS RAPTURIOUS
STANDARD ICON
9947010202403



CHAOS UNDIVIDED ICON
9947010202405



KHORNE ICON
BEARER BODY
9947010201801

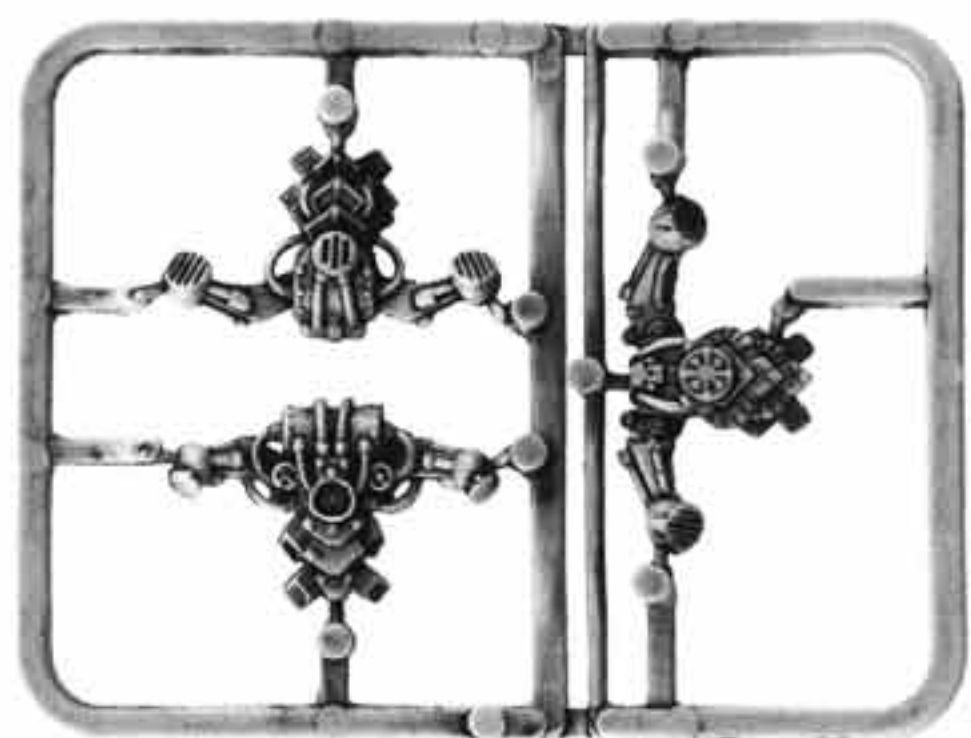

CLASSIC CHAOS BACKPACK SPRUE (3)
99399999004

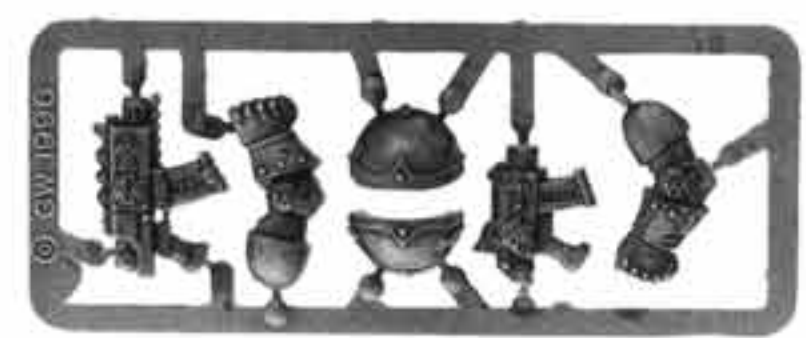

CLASSIC CHAOS MARINE ARM SPRUE (3)
99399999006

All miniatures are supplied unpainted. Models, bits, and sprues are all shown actual size unless otherwise noted. Contents may vary slightly from those shown.



**Chaos Space Marine
Daemon Prince Box (1)**
99110102080



**DAEMON PRINCE
HEAD**
9947010208003



**DAEMON PRINCE
LEFT ARM**
9947010208011



**DAEMON PRINCE
RIGHT ARM**
9947010208006



**DAEMON PRINCE
LEFT VENT**
9947010208004



**DAEMON PRINCE
RIGHT VENT**
9947010208002



**DAEMON PRINCE
LEFT LEG**
9947010208013



**DAEMON PRINCE
RIGHT LEG**
9947010208012



**DAEMON PRINCE
TORSO BACK**
9947010208009



**DAEMON PRINCE
TORSO FRONT**
9947010208008



**DAEMON PRINCE
SWORD**
9947010208007



**DAEMON PRINCE
SHOULDER PAD 1**
9947010208001



**DAEMON PRINCE
SHOULDER PAD 2**
9947010208005



**DAEMON PRINCE
LEFT HAND**
9947010208010



CONVERTING YOUR DAEMON PRINCE



The plastic Dragon Wings (99380299002) make a great addition to your Daemon Prince. They fit so well that the conversion will require minimal putty work to smooth out the join.



This Daemon Prince's head was converted to fit into the theme of an Iron Warriors army. Some careful putty work was applied to create a steel mask that covers the creature's mouth. The Inquisitor range also has many heads that are appropriately sized.



The Chapter symbol on the left shoulder pad is a great way to proclaim the allegiance of your Daemon Prince. This example shows an Iron Warriors insignia made from green stuff.



DRAGON WINGS SPRUE
(SHOWN 60% ACT. SIZE)
99380299002



HQ



Abaddon the Despoiler Blister (1)
99060102026



ABADDON HEAD
9947010202602



**ABADDON DAEMON
SWORD DRACH'NYEN**
9947010202606



**ABADDON RIGHT
TROPHY RACK**
9947010202603



ABADDON BODY
9947010202601



**ABADDON TALON
OF HORUS**
0994710202605



**ABADDON LEFT
TROPHY RACK**
9947010202604



Cypher Blister (1)
99060102057



CYPHER BODY
9947010205701



CYPHER BACKPACK
9947010205702



CYPHER BOLT PISTOL
9947010205704



CYPHER SWORD
9947010205703



CYPHER PLASMA PISTOL
9947010205705



Fabius Bile Blister (1)
99060102006



Fabius Bile is available only via Special Offer.



FABIUS BILE BODY
9947010200601



FABIUS BILE BACKPACK
9947010200604



XYCLOS NEEDLER
9947010200602



ROD OF TORMENT
9947010200603



CHIRURGEON ARM 1
9947010200605



CHIRURGEON ARM 2
9947010200606



Ahriman Blister (1)
99060102016



AHRIMAN BODY
9947010201601



Khârn the Betrayer Blister (1)
99060102014



KHÂRN HEAD
9947010201402



THE BLACK STAFF
9947010201602



AHRIMAN HEAD
9947010201603



KHÂRN BODY
9947010201401



KHÂRN PLASMA PISTOL
9947010201403



AHRIMAN BACKPACK
9947010201604



KHÂRN BACKPACK
9947010201404



Typhus, Herald of Nurgle Blister (1)
99060102084



TYPHUS BODY
9947010208404



TYPHUS BACKPACK
9947010208403



TYPHUS HEAD SPRUE
9947010208401



TYPHUS SCYTHE
9947010208402



The Chaos Space Marine Champion is available only via Special Offer.



**Chaos Space Marine
Champion Blister (Random 1)**
99060102027



**CHAOS SPACE
MARINE CHAMPION 1**
9947010202701



**CHAOS SPACE
MARINE CHAMPION 2**
9947010200403

The Chaos Space Marines come with the Classic Chaos Backpack Sprue (99399999004), the Classic Space Marine Arm Sprue (99399999006), and the Chaos Space Marine Arm (9947010202702) found with the Icon Bearer.



The Khorne Lord on Juggernaut is available only via Special Offer.



Khorne Lord on Juggernaut Box (1)
99110102001



JUGGERNAUT RIDER BODY
9947010200101



JUGGERNAUT BODY
9947010200103



JUGGERNAUT HEAD
9947010200105



JUGGERNAUT RIDER ARM
9947010200102



**JUGGERNAUT RIGHT
FRONT LEG**
9947010200106



**JUGGERNAUT LEFT
FRONT LEG**
9947010200107



**JUGGERNAUT
RIGHT REAR LEG**
9947010200108



**JUGGERNAUT
LEFT REAR LEG**
9947010200109



JUGGERNAUT HEAD PLATE
9947010200104

ELITES



Chaos Obliterator Blister (Random 1)
99060102075



OBLITERATOR TORSO 1
9947010207504



OBLITERATOR TORSO 2
9947010207506



OBLITERATOR BODY 1
9947010207503



OBLITERATOR BODY 2
9947010207505

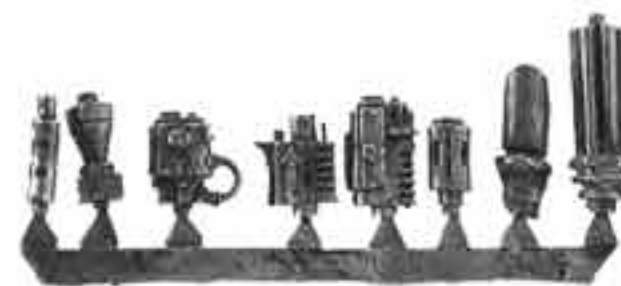

OBLITERATOR GUN SPRUE
9947010207508



OBLITERATOR BLADE SPRUE
9947010207509



OBLITERATOR HEAD (RANDOM 1)
9947010207501



OBLITERATOR RIGHT ARM (RANDOM 1)
9947010207502



OBLITERATOR LEFT ARM (RANDOM 1)
9947010207507



ELITES



Chosen Terminator Squad Box (5)

99110102002

Chosen Terminator Blister (Random 1)

99060102009



**CHAOS TERMINATOR
HEAD 1**
9947010200208



**CHAOS TERMINATOR
HEAD 2**
9947010200210



**CHAOS TERMINATOR
HEAD 3**
9947010200212



**CHAOS TERMINATOR
HEAD 4**
9947010200209



**CHAOS TERMINATOR
HEAD 5**
9947010200211



**CHAOS TERMINATOR
COMBI-BOLTER 1**
9947010200213



**CHAOS TERMINATOR
LEFT TROPHY RACK 1**
9947010200205



**CHAOS TERMINATOR
LEFT TROPHY RACK 2**
9947010200207



**CHAOS TERMINATOR
RIGHT TROPHY RACK 1**
9947010200204



**CHAOS TERMINATOR
RIGHT TROPHY RACK 2**
9947010200206



**CHAOS TERMINATOR
COMBI-BOLTER 2**
9947010200215



**CHAOS TERMINATOR
BODY 1**
9947010200201



**CHAOS TERMINATOR
BODY 2**
9947010200202



**CHAOS TERMINATOR
BODY 3**
9947010200203



**CHAOS TERMINATOR
BOLTER-FLAMER**
9947010200216

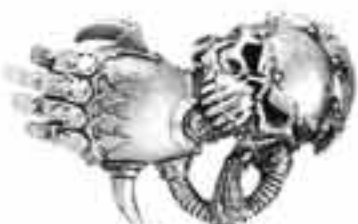

**CHAOS TERMINATOR
POWER FIST**
9947010200219



**CHAOS TERMINATOR
POWER MACE**
9947010200220



**CHAOS TERMINATOR
CHAINFIST**
9947010200221



**CHAOS TERMINATOR
CHAIN AXE**
9947010200218

All miniatures are supplied unpainted. Models, bits, and sprues are all shown actual size unless otherwise noted. Contents may vary slightly from those shown.

The Chosen Terminator blisters below come with bitsz on the opposite page (i.e., the Champion comes with one random right arm and one random left arm out of all the left arms shown on both pages).

ELITES



Chosen Terminator Champion Blister (Random 1)
99060102015



CHAOS TERMINATOR CHAMPION BODY
9947010201501



CHAOS TERMINATOR CHAMPION HEAD 1
9947010201502



CHAOS TERMINATOR CHAMPION HEAD 2
9947010201503



CHAOS TERMINATOR CHAMPION RIGHT RACK
9947010201504



CHAOS TERMINATOR CHAMPION LEFT RACK
9947010201505



CHAOS TERMINATOR CHAMPION LIGHTNING CLAW
9947010201506



CHAOS TERMINATOR CHAMPION POWER AXE
9947010201507



Chosen Terminator w/ Heavy Flamer Blister (Random 1)
99060102011



Chosen Terminator w/ Reaper Cannon Blister (Random 1)
99060102010



Chosen Terminator w/ Bolter-Melta Blister (Random 1)
99060102086



CHAOS TERMINATOR HEAVY FLAMER
9947010201122

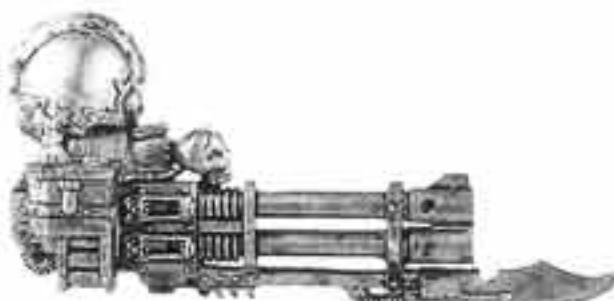

CHAOS TERMINATOR REAPER AUTOCANNON
9947010200217



CHAOS TERMINATOR BOLTER-MELTA
9947010200214



ELITES



Thousand Sons Space Marine Squad Box (9)
99110102073

The Thousand Sons Squad comes with a Chaos Sorcerer Bolt Pistol Arm 1 (9947010201305) and Chaos Sorcerer Backpack 2 (9947010201306) shown in HQ.

CHAOS SPACE MARINE TRANSFER SHEET

CHAOS SPACE MARINE DECAL SHEET (SHOWN 90% ACTUAL SIZE)
99510102002

COMPONENT NUMBER: 99 51 01 02 002



THOUSAND SONS TORSO 1
9947010207306



THOUSAND SONS TORSO 2
9947010207307



THOUSAND SONS ARMS SPRUE
9947010207303



THOUSAND SONS GUN SPRUE
9947010207305



CHAOS BACKPACK SPRUE (RANDOM 1)
99390102003



THOUSAND SONS HEADS SPRUE 1
9947010207301



THOUSAND SONS HEADS SPRUE 2
9947010207302



THOUSAND SONS SHOULDER PADS
9947010207304



THOUSAND SONS CHAMPION
9947010207308

All miniatures are supplied unpainted. Models, bits, and sprues are all shown actual size unless otherwise noted. Contents may vary slightly from those shown.

ELITES



The Emperor's Children Squad comes with the Chaos Space Marine Decal Sheet (99510102002) and Chaos Backpack Sprue (99390102003) shown on the opposite page.

Emperor's Children Squad Box (8)
99110102065



EMPEROR'S CHILDREN BLASTMASTER
9947010206501



EMPEROR'S CHILDREN ARM 1
9947010206505



EMPEROR'S CHILDREN ARM 2
9947010206506



EMPEROR'S CHILDREN TORSO
9947010206510



EMPEROR'S CHILDREN HEAD 1
9947010206507



EMPEROR'S CHILDREN HEAD 2
9947010206508



EMPEROR'S CHILDREN SONIC BLASTER
9947010206502



EMPEROR'S CHILDREN POWER SWORD
9947010206503



EMPEROR'S CHILDREN BACKPACK
9947010206504



EMPEROR'S CHILDREN HEAD 3
9947010206509

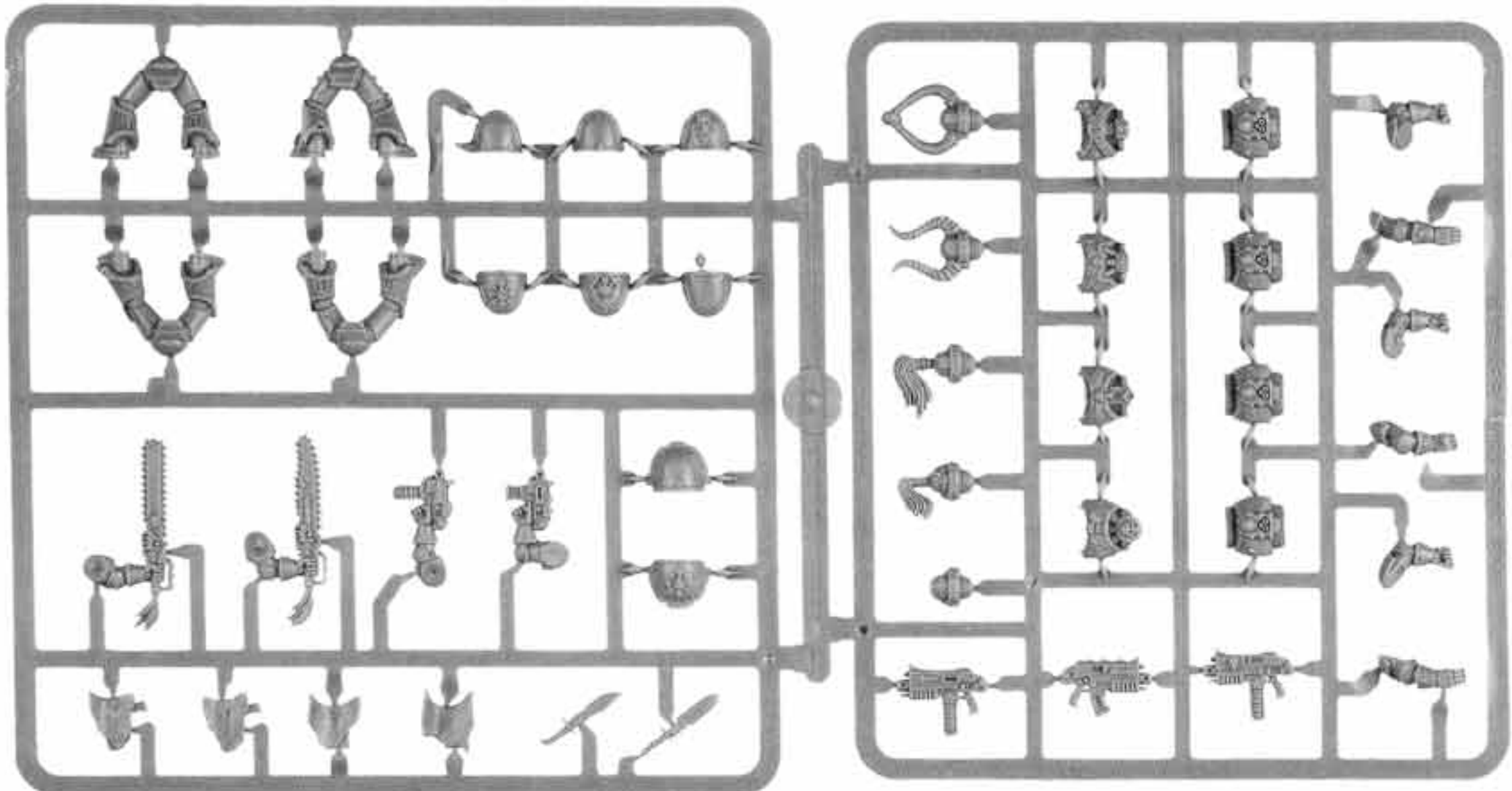

CHAOS SPACE MARINE SPRUE (SHOWN 80% ACTUAL SIZE)
99380102004



ELITES

The Khorne Berzerker Squad comes with the Classic Chaos Backpack Sprue (99399999004) shown in HQ and Chaos Space Marine Decal Sheet (99510102002) shown previously.



Khorne Berzerker Squad Box (12)
99120102005

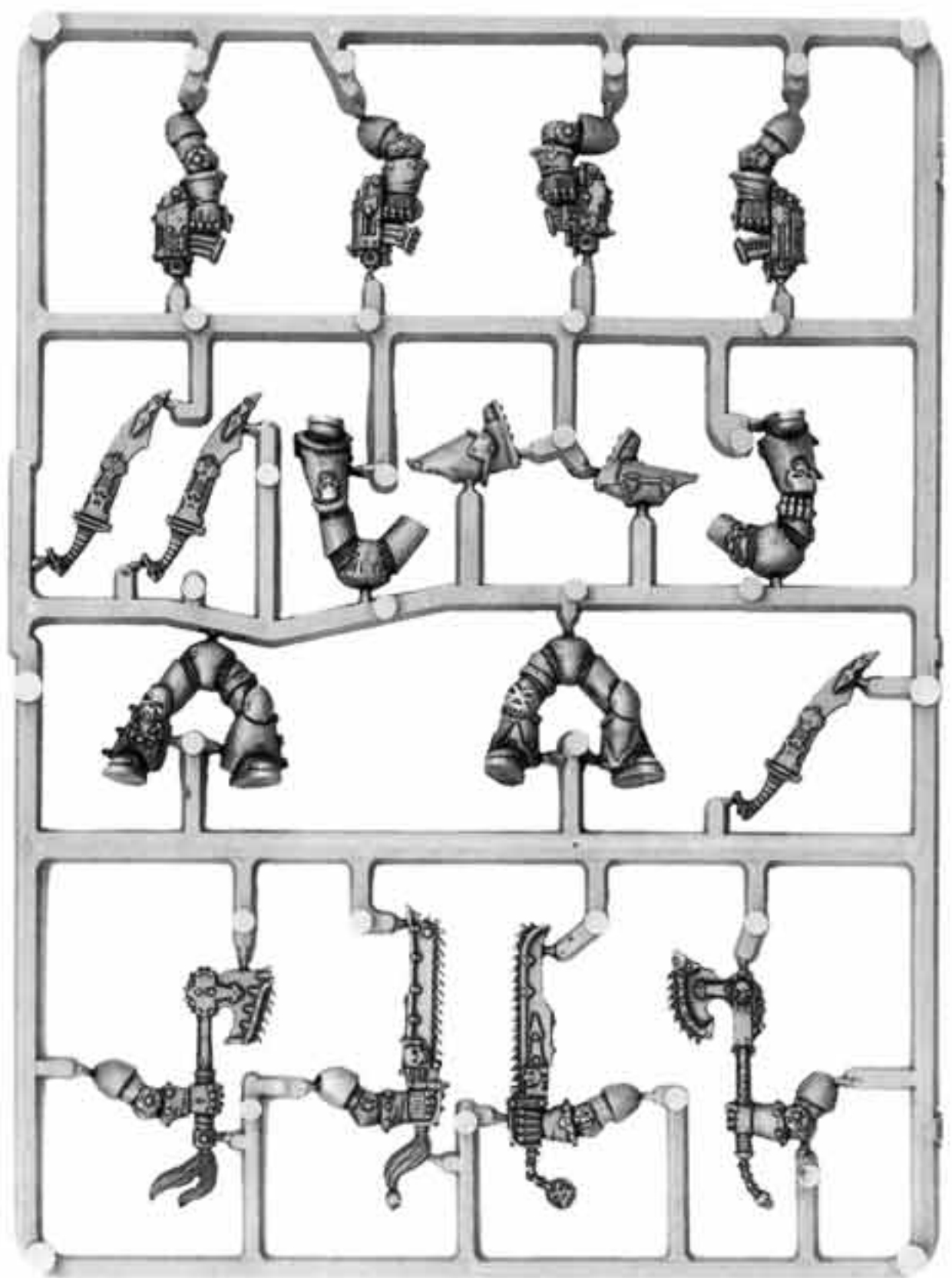
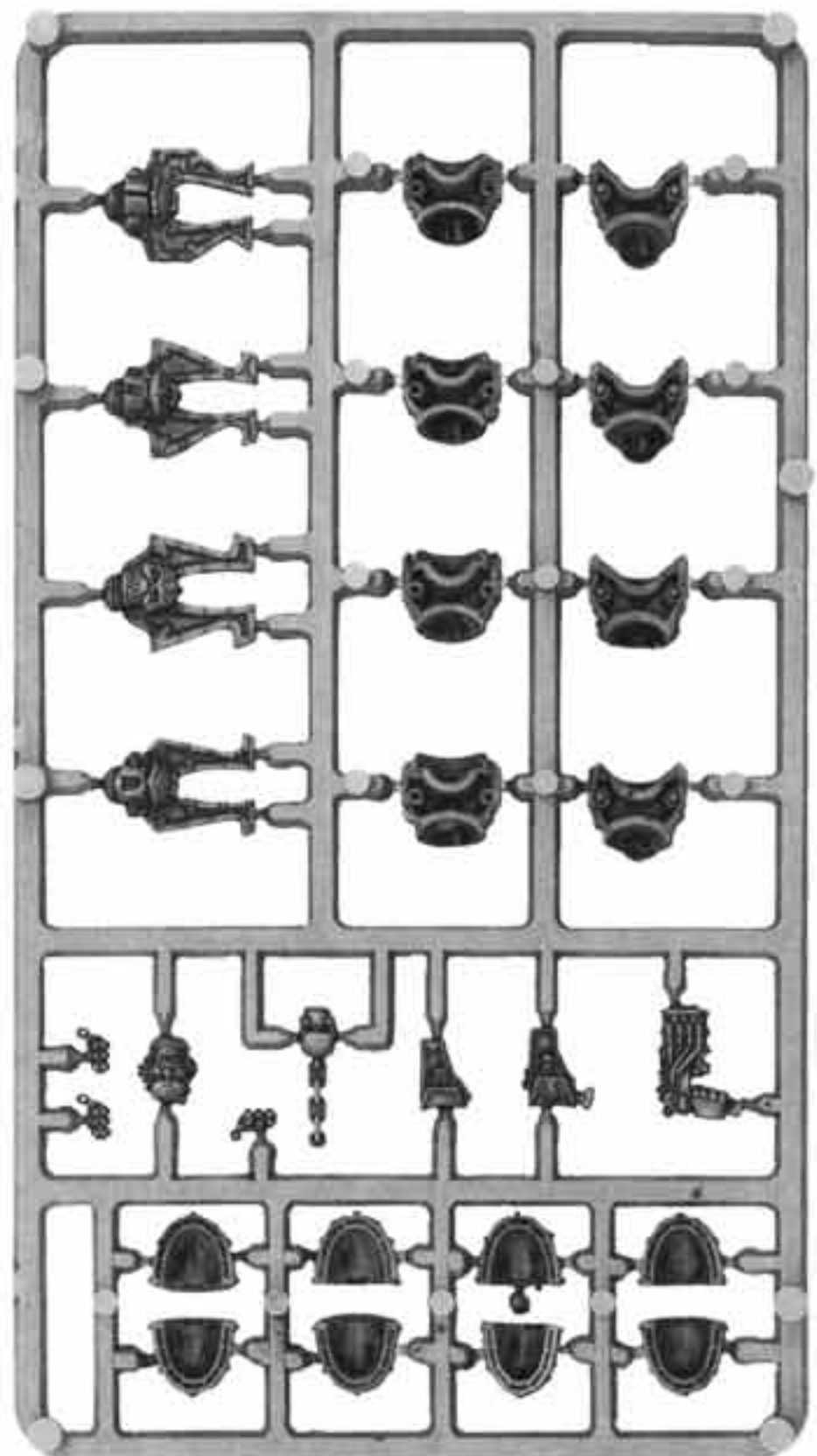

KHORNE BERZERKER PLASTIC SPRUE (SHOWN 80% ACTUAL SIZE)
99380102001

All miniatures are supplied unpainted. Models, lists, and sprues are all shown actual size unless otherwise noted. Contents may vary slightly from those shown.

ELITES



World Eaters Champion Blister (Random 1)
99060102093



World Eaters Champions are available only via Special Offer.



WORLD EATERS CHAMPION HEAD 1
9947010209301



WORLD EATERS CHAMPION HEAD 3
9947010209303



WORLD EATERS CHAMPION HEAD 2
9947010209302



WORLD EATERS CHAMPION BODY
9947010209304



WORLD EATERS CHAMPION WEAPON SPRUE 1
9947010209305

The World Eaters Champion comes with the Chaos Backpack Sprue (99390102003) shown previously.

The Khorne Berzerker Champion comes with the Classic Chaos Backpack Sprue (99399999004), the Classic Chaos Marine Arm Sprue (99399999006), and the Chaos Space Marine Arm (9947010202702) shown in HQ.



The Khorne Berzerker Champions are available only via Special Offer.



Khorne Berzerker Champion Blister (Random 1)
99060102017



BERZERKER CHAMPION 1
9947010201701



BERZERKER CHAMPION 2
9947010201702



BERZERKER CHAMPION 3
9947010201703



WORLD EATERS CHAMPION WEAPON SPRUE 2
9947010209306



WORLD EATERS CHAMPION WEAPON SPRUE 3
9947010209307



WORLD EATERS CHAMPION WEAPON SPRUE 4
9947010209308



ELITES

The Death Guard Plague Marine Squad comes with the Chaos Backpack Sprue (99390102003) shown previously.



Death Guard Sargeant
Blister is available only
via Special Offer.

Death Guard Plague Marines Box (7)
99110102083
Death Guard Champion Blister (1)
99060102092



ELITES



Plague Marine Champions are available only via Special Offer.



Plague Marine Champion Blister (Random 1)
99060102008

The Death Guard Champion comes with the Classic Chaos Backpack Sprue (99399999004) and Classic Chaos Marine Arm Sprue (99399999006) shown in HQ.



PLAGUE MARINE CHAMPION 1
9947010200801

PLAGUE MARINE CHAMPION 2
9947010200802

PLAGUE MARINE CHAMPION 3
9947010200803



Plague Marines w/ Assault Weapons are available only via Special Offer.



The Death Guard Plague Marine Squad comes with the Chaos Backpack Sprue (99390102003) shown previously.

Plague Marine w/ Assault Weapon Blister (1)
99060102087



PLAGUE MARINE W/ MELTAGUN
9947010200701



PLAGUE MARINE W/ PLASMA GUN
9947010200702

CONVERTING PLAGUE MARINES

Even with the many different Plague Marines available, you might find yourself wanting to convert a few yourself to make some variant special weapon troopers, icon bearers, Possessed, or just because!

RUPTURED INTESTINES



This Aspiring Champion has a mass of intestines spilling out of his armor – surely a sign of Nurgle's favor! Making the intestines is easy. Simply make long, thin "snakes" out of green stuff. Starting at the bottom and working to the top and front, layer the rolls of green stuff to give the impression that they are spilling out of a gap in the armor. While it isn't necessary, you can use one

of Cherubael's tabards from the Inquisitor line as both a tabard on the champion and to provide a base to which you can apply the lower bunch of intestines.

You can also see the use of plasticard to make thigh armor plates to make the armor look a bit more archaic and the horn from a Chaos Terminator trophy rack to make a helmet spike similar to the horns of a Plaguebearer. The hole in the side of the helmet is for the placement of a rebreather tube made from guitar wire.

BACKPACKS AND HELMETS

In keeping with the idea of the Plague Marines having older patterns of armor, you can use Skaven Poison Wind Globadier backpacks instead of Chaos Space Marine backpacks. Use guitar wire to link the plasma gun to the apparatus on the backpack. Spikes rescued from an old tank originally from the Chaos Vehicle Accessory sprue can add both height and some Chaos flair to the backpack.



You can convert the helmet to have a look similar to that of a gas mask. Sculpt lenses over the eyes, and use a vent from a Space Marine backpack to make a mouth grille.

Shown below are some more details you can add and an example of how they might look painted.





TROOPS

The Chaos Space Marine Rhino comes with the Chaos Space Marine Decal Sheet (99510102002) shown in Elites.



Chaos Space Marine Rhino Sprues shown on opposite page.



Chaos Space Marine Rhino Box (1)
99120102011



Chaos Space Marine Squad Box (8)
99120102008

The Chaos Space Marine Squad Box comes with the Chaos Space Marine Sprue (99380102004), the Chaos Backpack Sprue (99390102003), and the Chaos Space Marine Decal Sheet (99510102002) shown in Elites.

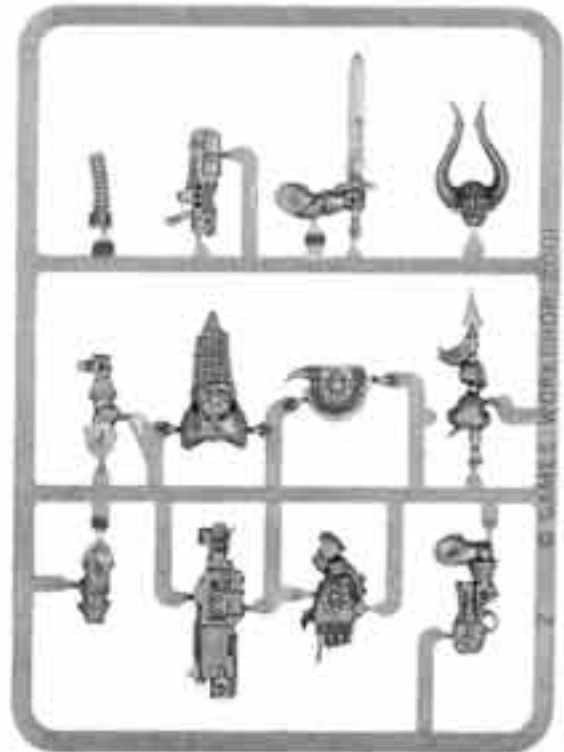

CHAOS SPACE MARINE ACCESSORY SPRUE (SHOWN 50% ACTUAL SIZE)
99380102005

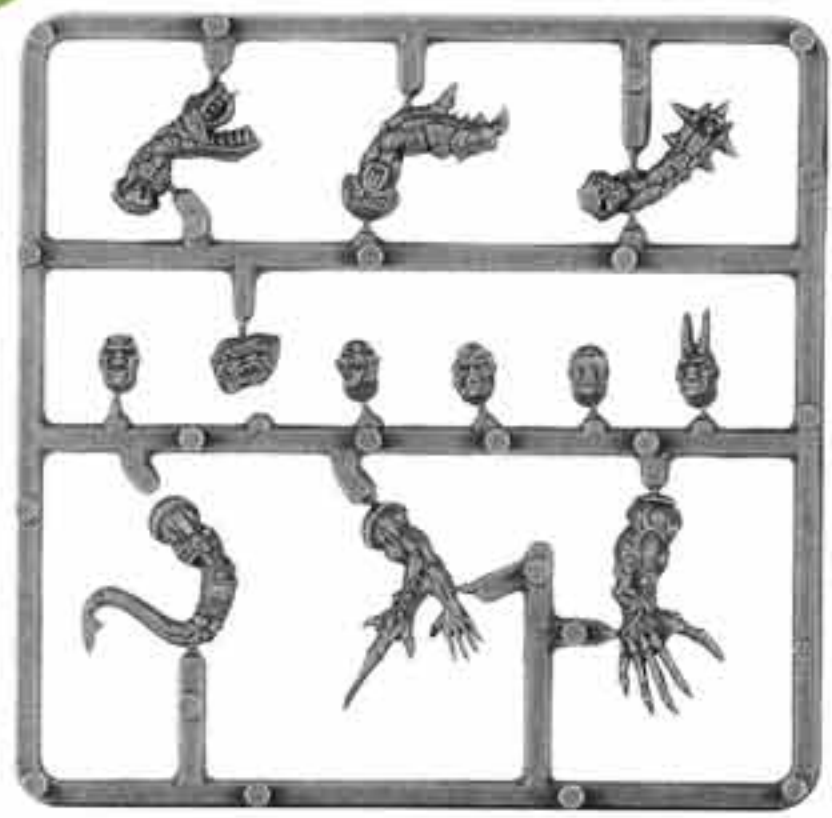

CHAOS MUTATIONS SPRUE
99380102003

All miniatures are supplied unpainted. Models, bits, and sprues are all shown actual size unless otherwise noted. Contents may vary slightly from those shown.

TROOPS

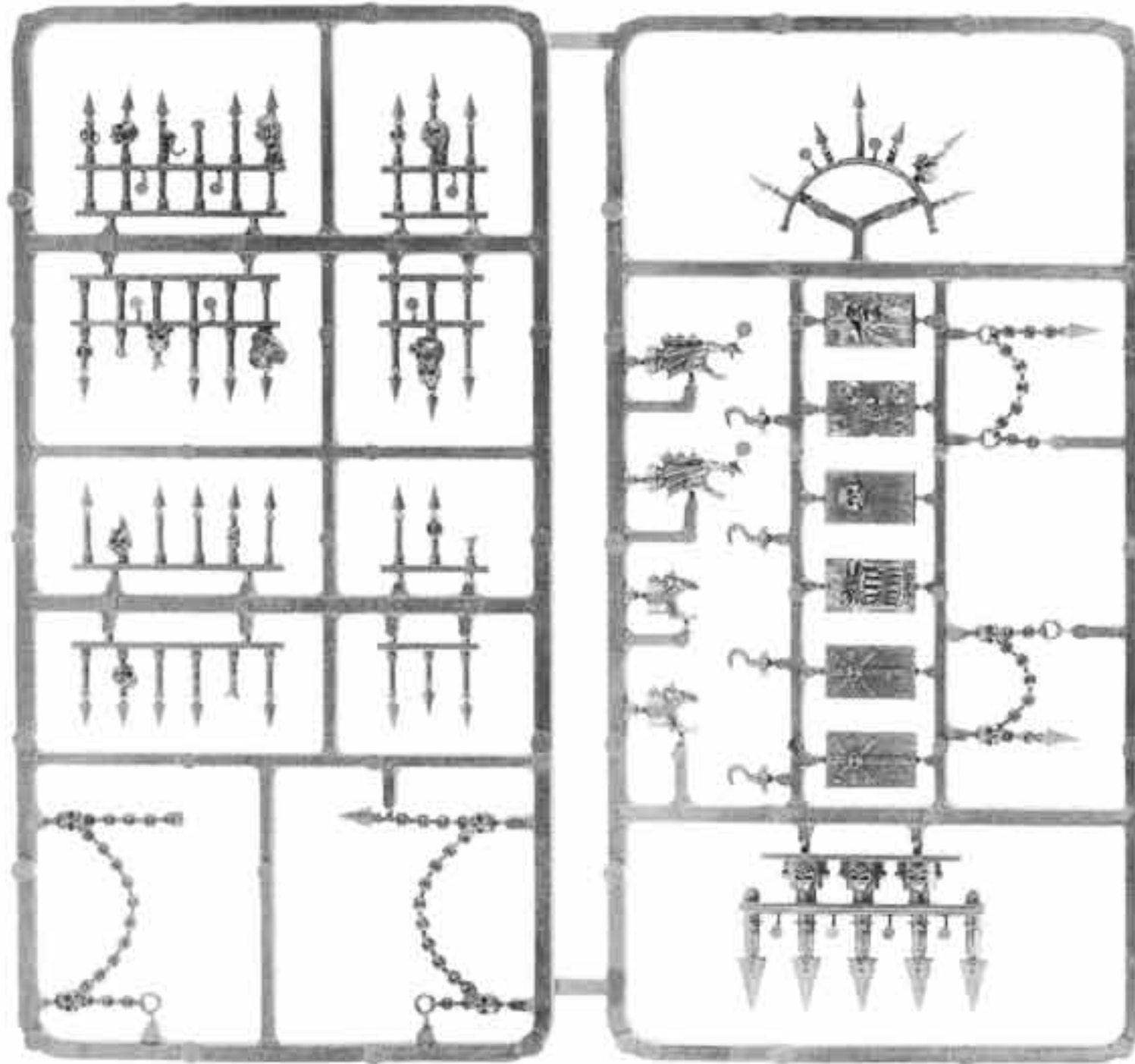

CHAOS VEHICLE ACCESSORY SPRUE 1 (SHOWN 65% ACTUAL SIZE)
99390102001

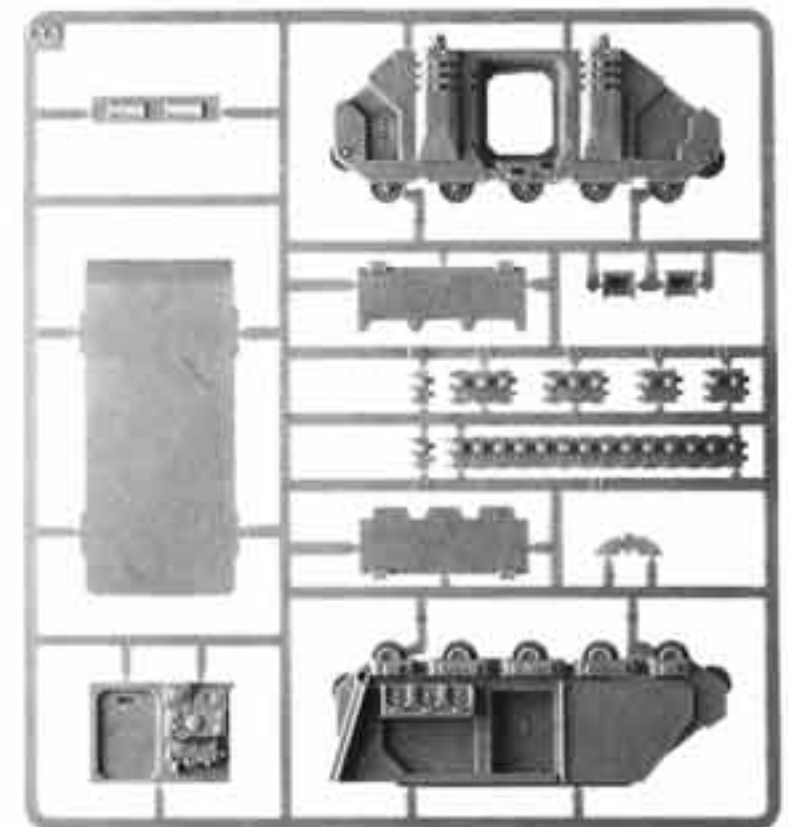

RHINO SPRUE 1 (SHOWN 30% ACTUAL SIZE)
99390199004

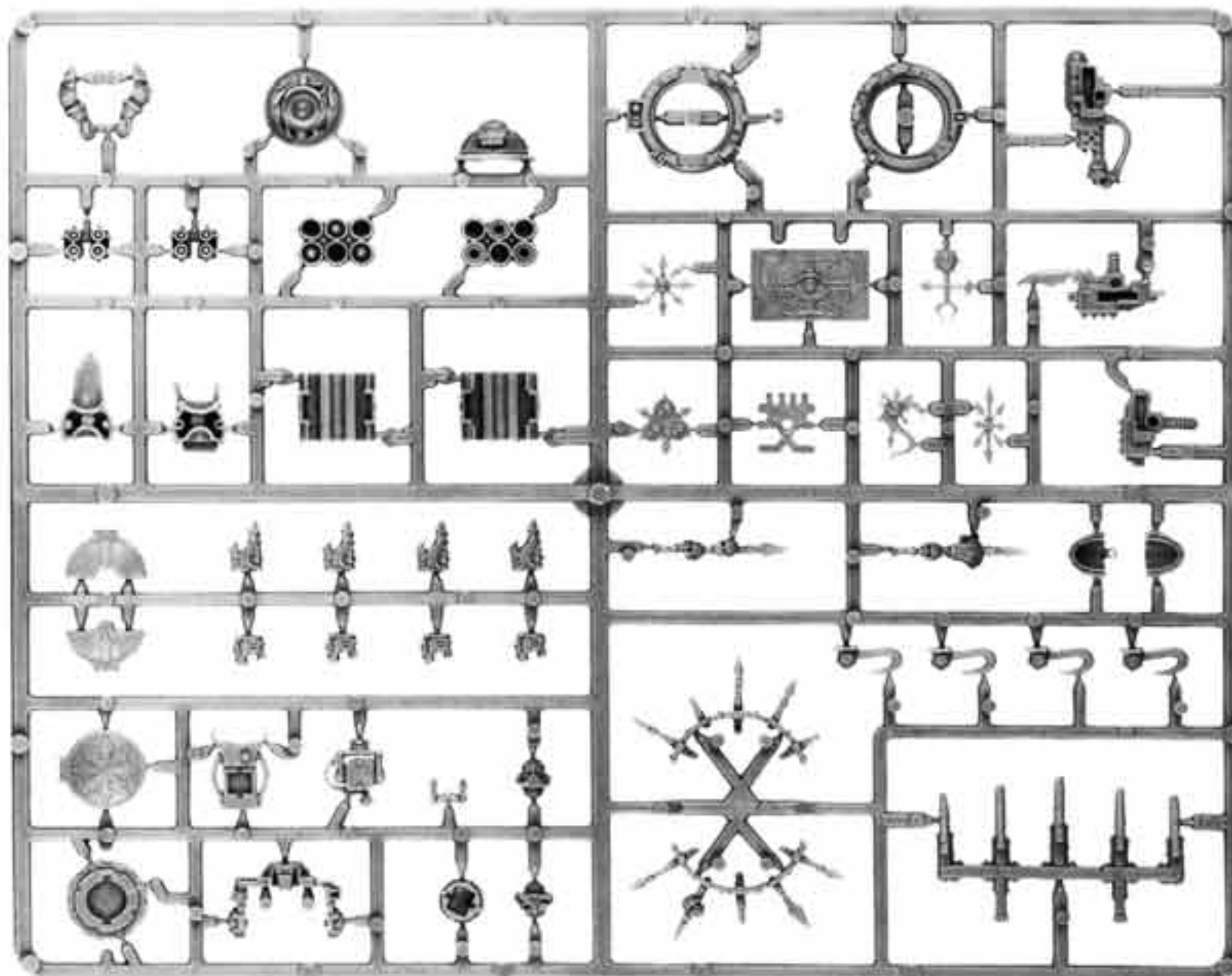

CHAOS VEHICLE ACCESSORY SPRUE 2 (SHOWN 50% ACTUAL SIZE)
99390102004

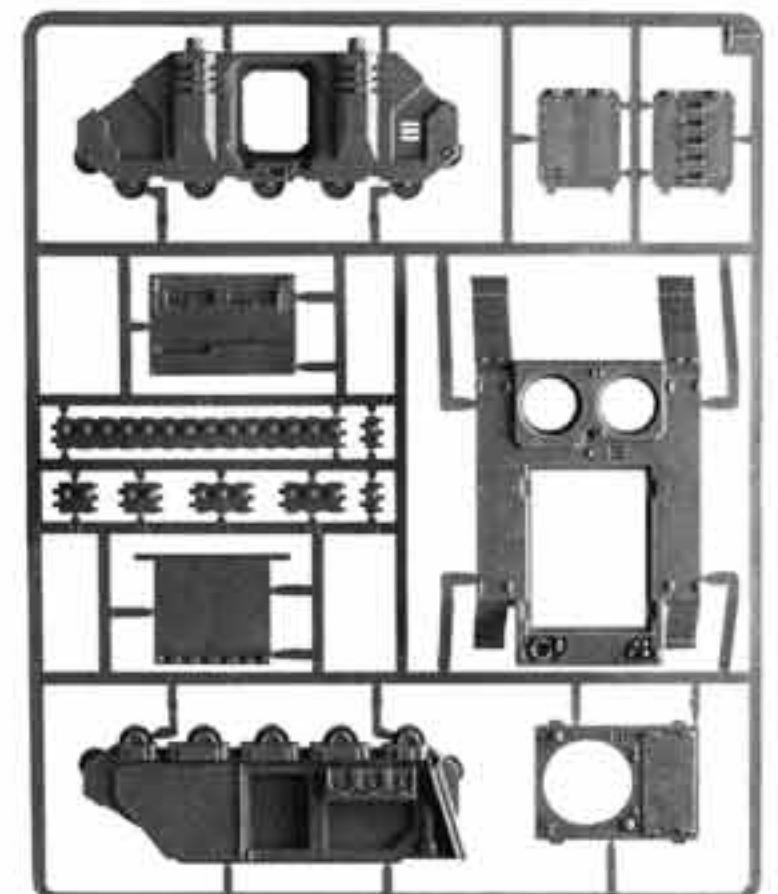

RHINO SPRUE 2 (SHOWN 30% ACTUAL SIZE)
99390199005



TROOPS



Iron Warriors Squad Box (8)
99110102067



IRON WARRIOR LASCANNON
9947010206701



IRON WARRIOR LASCANNON ARM
9947010206702



IRON WARRIOR MELTA GUN
9947010206703



IRON WARRIOR TORSO
9947010206704



IRON WARRIOR HEAD 1
9947010206705



IRON WARRIOR HEAD 2
9947010206706



IRON WARRIOR HEAD 3
9947010206707



IRON WARRIOR HEAD 4
9947010206708

The Iron Warriors and Night Lords come with the Chaos Space Marine Sprue (99380102004), the Chaos Marine Accessory Sprue (99380102005), the Chaos Backpack Sprue (99390102003), and the Chaos Space Marine Decal Sheet (99510102002) shown in Elites.



Night Lord Squad Box (8)
99110102081



NIGHT LORD LEFT ARM
9947010208110



NIGHT LORD HEAD 1
9947010208101



NIGHT LORD HEAD 2
9947010208102



NIGHT LORD HEAD 3
9947010208103



NIGHT LORD HEAD 4
9947010208104



NIGHT LORD HEAD 5
9947010208105



NIGHT LORD SHOULDER PAD 1
9947010208106



NIGHT LORD SHOULDER PAD 2
9947010208107



NIGHT LORD SHOULDER PAD 3
9947010208108



NIGHT LORD SHOULDER PAD 4
9947010208109

All miniatures are supplied unpainted. Models, bits, and sprues are all shown as they will appear unless otherwise noted. Contents may vary slightly from those shown.

TROOPS

The Chaos Space Marines with Assault Weapons come with the Classic Chaos Backpack Sprue (99399999004) shown in Elites.



Chaos Space Marine w/ Assault Weapon Blister (2)
99060102088



CHAOS SPACE MARINE W/ FLAMER
9947010200401



CHAOS SPACE MARINE W/ PLASMA GUN
9947010202802



These Chaos Space Marines are available only via Special Offer.

The Chaos Space Marines come with the Classic Chaos Backpack Sprue (99399999004), Classic Space Marine Arm Sprue (99399999006) found with the Icon Bearer.



Chaos Space Marine Blister (Random 2)
99060102029



CHAOS SPACE MARINE 1
9947010202903



CHAOS SPACE MARINE 2
9947010202904



CHAOS SPACE MARINE 3
9947010202905



CHAOS SPACE MARINE 4
9947010202906



CHAOS SPACE MARINE 5
9947010202907



CHAOS SPACE MARINE 6
9947010202908



CHAOS SPACE MARINE 7
9947010200402



FAST ATTACK

The Chaos Raptor Squad comes with the Chaos Space Marine Decal Sheet (99510102002) shown in Elites. The Chaos Raptor Blister (99060102070) does not include the Raptor with Assault Weapon or the Champion.



Chaos Raptor Squad Box (5)
99110102071

Chaos Raptor Blister (Random 1)
99060102070

Chaos Raptor w/ Assault Weapon Blister (1)
99060102069



CHAOS RAPTOR JUMP PACK 1
9947010207111



CHAOS RAPTOR JUMP PACK 2
9947010207112



CHAOS RAPTOR JUMP PACK 3
9947010207113



CHAOS RAPTOR CHAMPION ARM
9947010207107



CHAOS RAPTOR RIGHT ARM 2
9947010207108



CHAOS RAPTOR RIGHT ARM 3
9947010207109



CHAOS RAPTOR RIGHT ARM 4
9947010207110

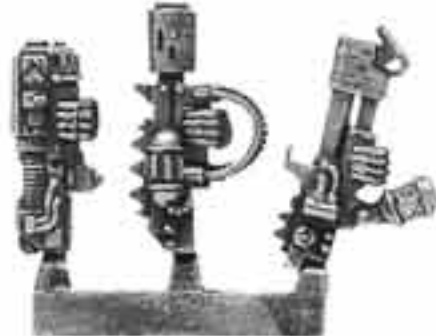

CHAOS RAPTOR ASSAULT WEAPONS
9947010207106



CHAOS RAPTOR BODY 2
9947010207102



CHAOS RAPTOR BODY 3
9947010207103



CHAOS RAPTOR BODY 4
9947010207104



CHAOS RAPTOR ASSAULT WEAPON BODY
9947010207105



CHAOS RAPTOR CHAMPION BODY
9947010207101

All quantities are supplied unpainted. Models, bits, and sprues are all shown actual size unless otherwise noted. Contents may vary slightly from those shown.



Chaos Space Marine Biker Box (1)
99120102003



FAST ATTACK



Chaos Space Marine Biker Squadron
Available Only as Bitz



Chaos Space Marine Biker Squadron above is only available as the bitz shown below via Special Offer.



CHAOS BIKER HEAD 1
9947010205901



CHAOS BIKER HEAD 2
9947010205902



CHAOS BIKER HEAD 3
9947010205903



CHAOS BIKER TORSO
9947010205906



CHAOS BIKER SHOULDER PAD
9947010205905



CHAOS BIKER PLASMA GUN
9947010205910



CHAOS BIKER MELTA GUN
9947010205911



CHAOS BIKER SCANNER
9947010205909



CHAOS BIKER POWER SWORD
9947010205904



CHAOS BIKER HOLSTER 1
9947010205907



CHAOS BIKER HOLSTER 2
9947010205908



SMALL TIRE SPRUE
99399999034

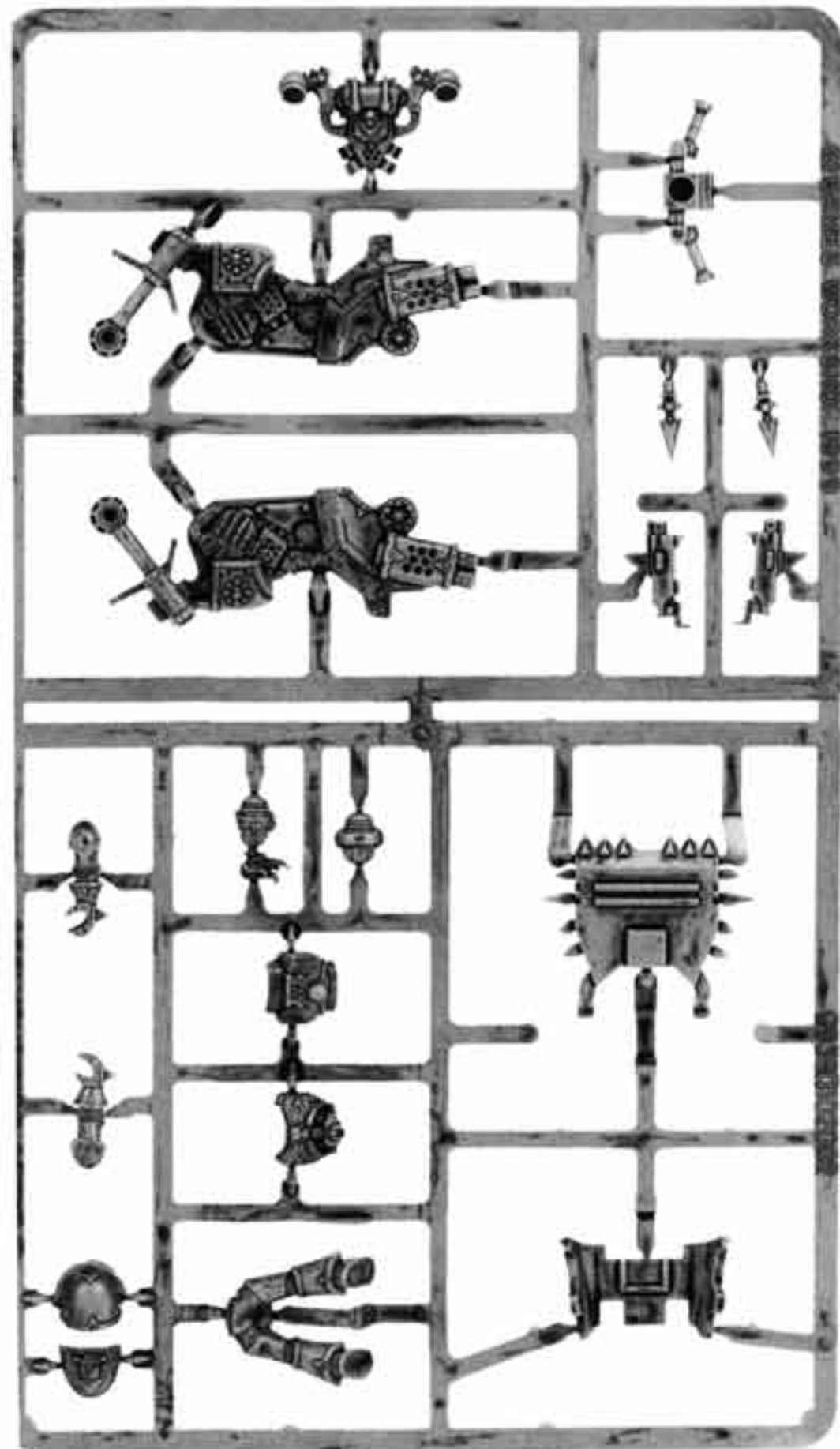

CHAOS BIKER PLASTIC SPRUE
(SHOWN 80% ACTUAL SIZE)
AVAILABLE ONLY IN BOX



HEAVY SUPPORT

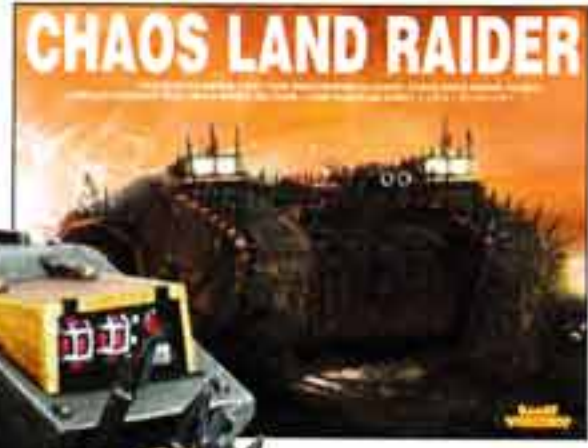

The Chaos Land Raider uses the Chaos Tank Accessory Sprue 1 & 2 (99390102001 & 4) shown with the Chaos Rhino in HQ.

Chaos Land Raider Tank Box (1)
99120102010

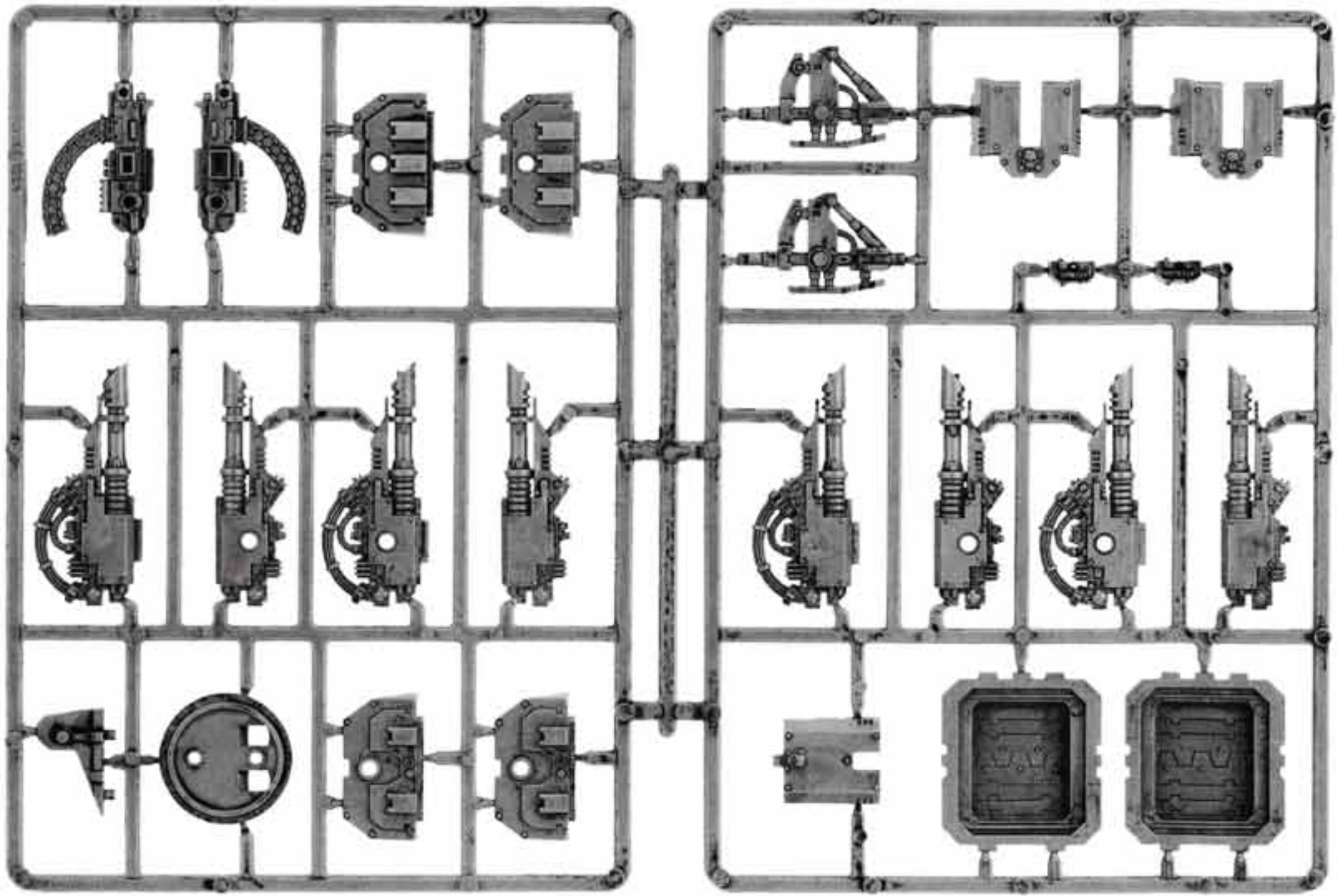

LAND RAIDER SPONSON SPRUE (SHOWN 50% ACT. SIZE)
99390101003

All miniatures are supplied unpainted. Models, kits, and sprues are all shown actual size unless otherwise noted. Contents may vary slightly from those shown.

HEAVY SUPPORT

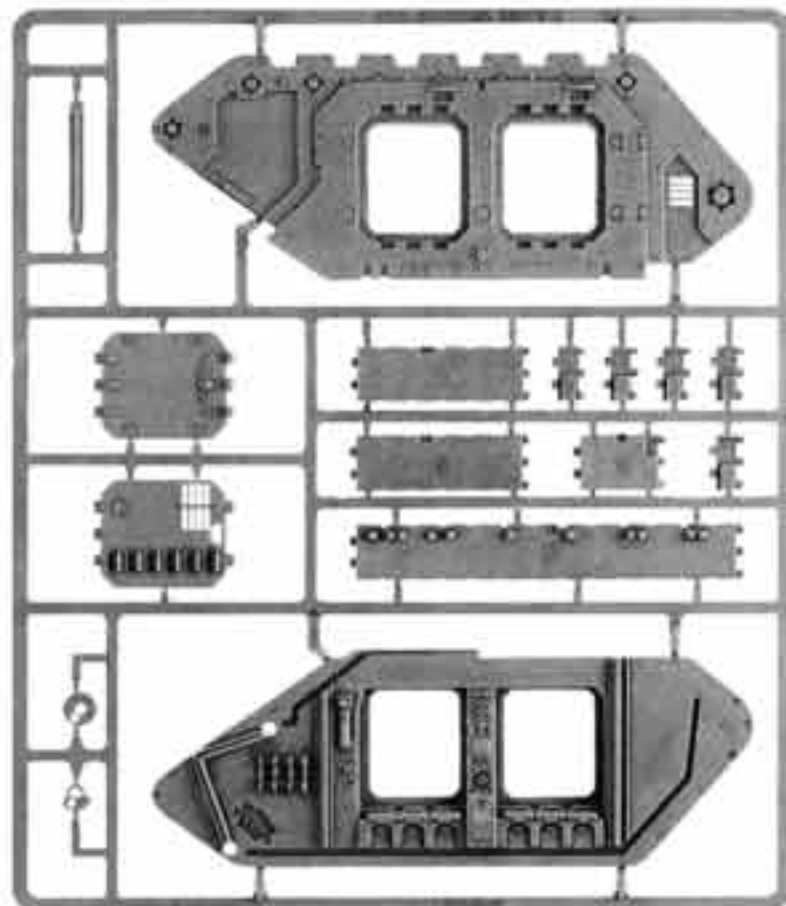

LAND RAIDER RIGHT TRACK SPRUE
(SHOWN 30% ACT. SIZE)
99390101007

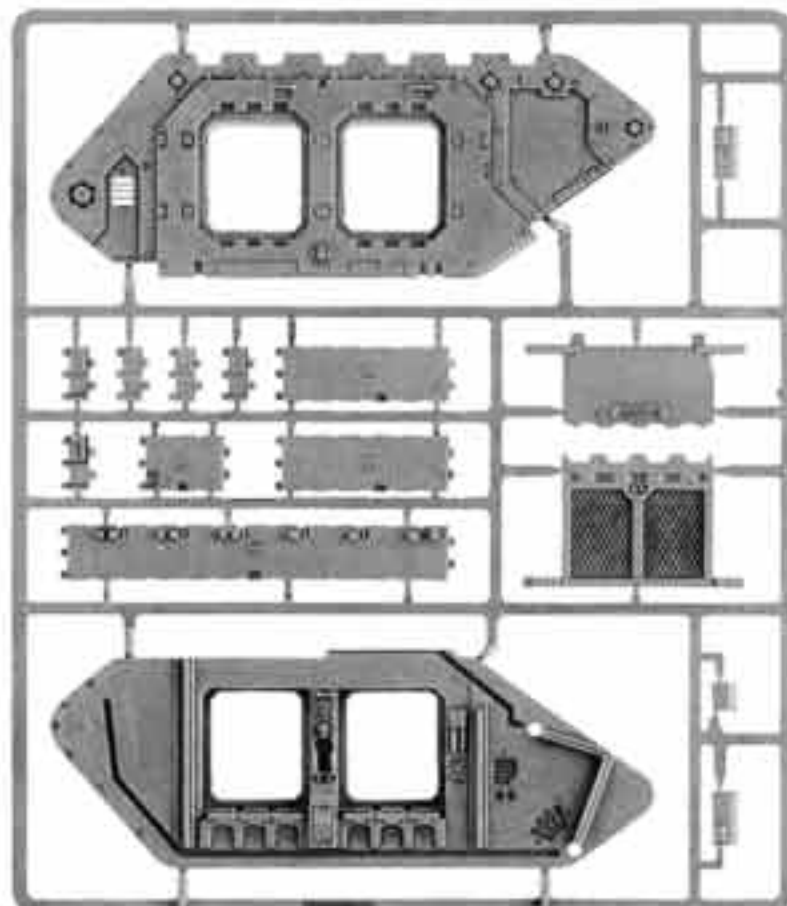

LAND RAIDER LEFT TRACK SPRUE
(SHOWN 30% ACT. SIZE)
99390101002

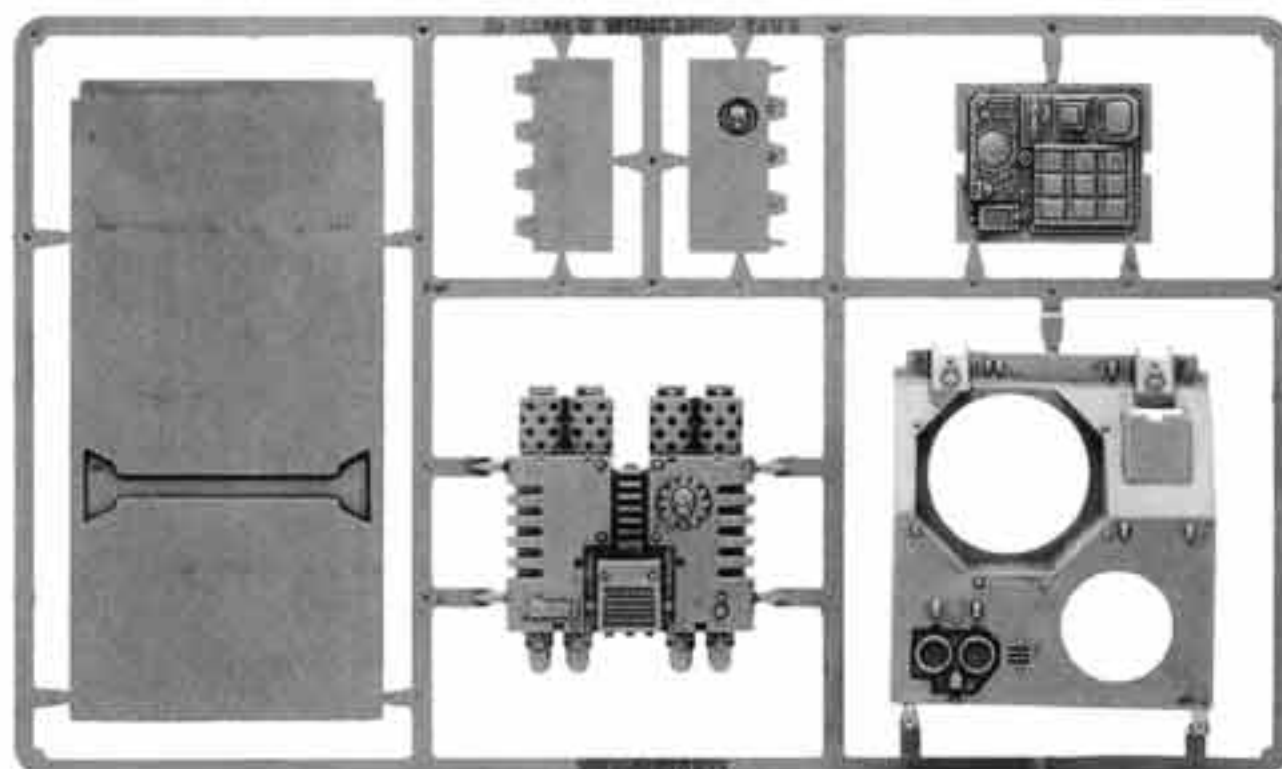

LAND RAIDER FLOOR SPRUE (SHOWN 50% ACT. SIZE)
99390101006

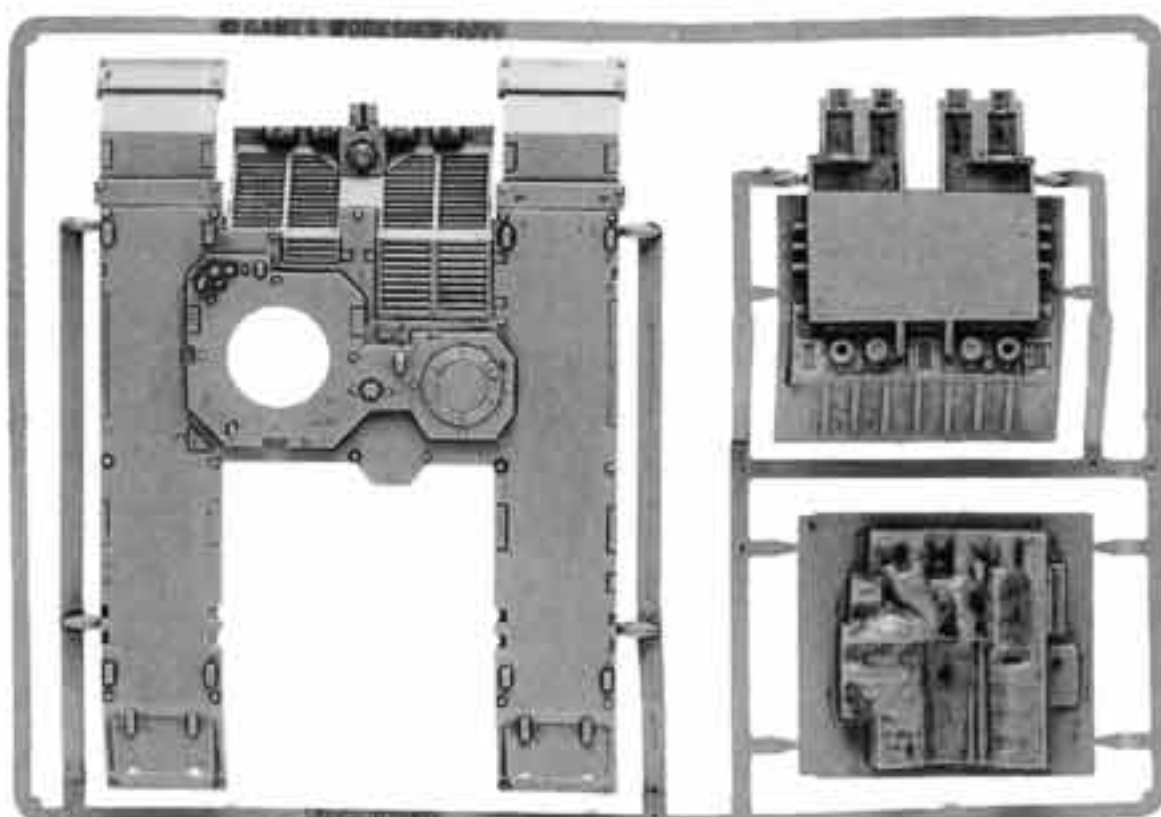

LAND RAIDER TOP SPRUE (SHOWN 50% ACT. SIZE)
99390101005

ADDING CHAOTIC DETAIL TO TANKS

Though bits on the Chaos Vehicle Sprue can make any tank fit into a Chaos Space Marine army, a few extra details will make your tanks look even more evil and corrupt!

RIVETED BANDING

One of the defining characteristics of Chaos Space Marine armor is the use of banding around armor plates. Adding similar detail will help tie your infantry and vehicles together visually and make the tanks look like they are older patterns. Take a piece of plasticard strip to make the banding. You can make rivets made a leather punch tool. The tool shown here is a Golden Eagle leather punch (just search for the terms "leather punch" and "golden eagle" on an internet search engine to find one for purchase).



SPIKE INFESTATION

A good way to depict various forms of Daemonic influence is to have things bursting through the armor. To model spikes on your vehicles, carve some out of pieces of sprue. Drill holes into the armor of your tank where you want the spikes to go. Glue the spikes into the holes from the back – this technique helps to suggest that the spikes are bursting through the armor. Use some green stuff to add a bit of detail around the holes.





HEAVY SUPPORT



The Chaos Predator comes with Chaos Tank Accessory Sprue 1 & 2 (99390102001 & 4) and Rhino Sprue 1 & 2 (99390199004 & 5) shown with the Chaos Rhino in HQ, and the Chaos Space Marine Decal Sheet (99510102002) shown in Elites.

Chaos Predator Tank Box (1)
99120102012

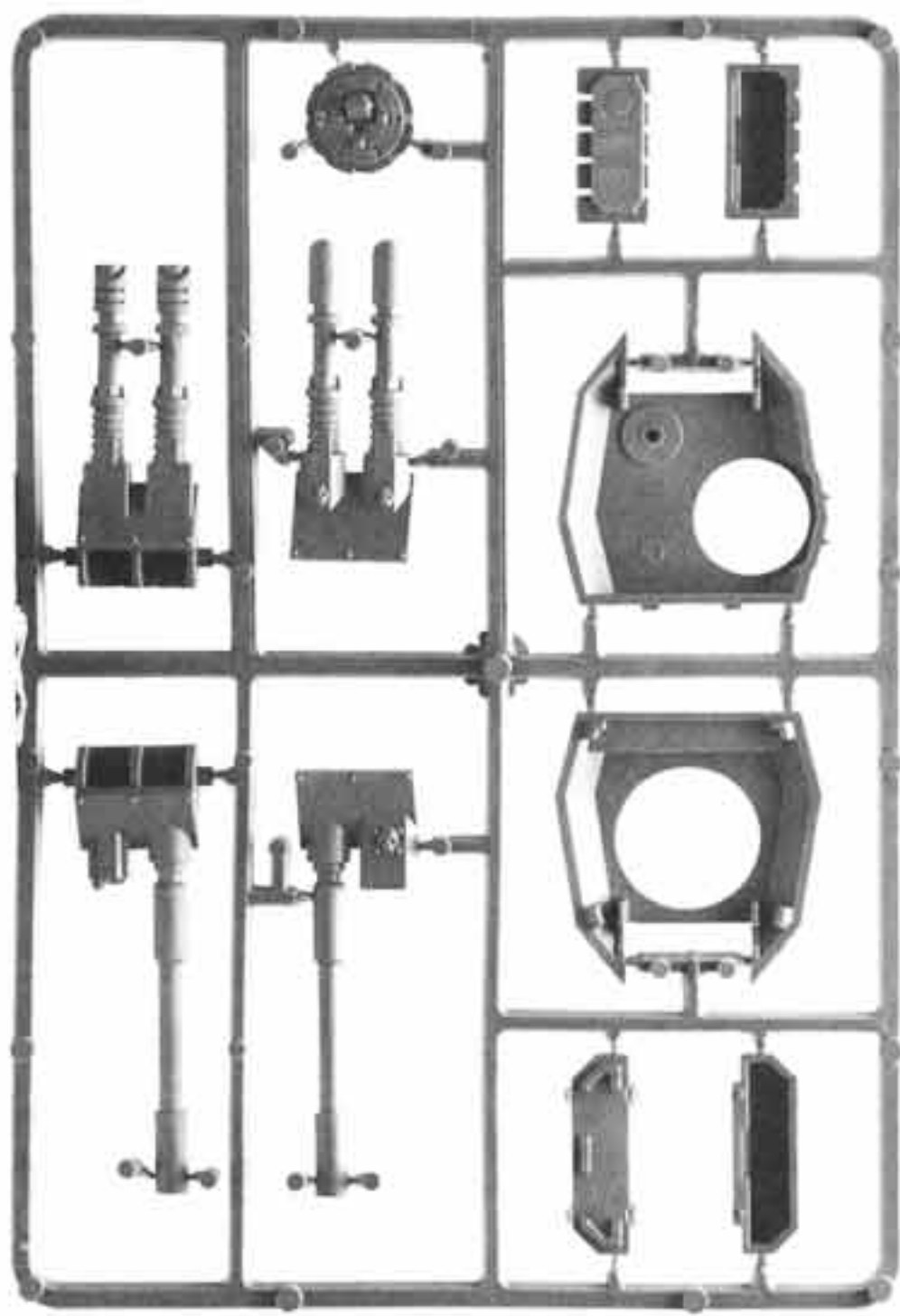

PREDATOR TURRET SPRUE
99390199007

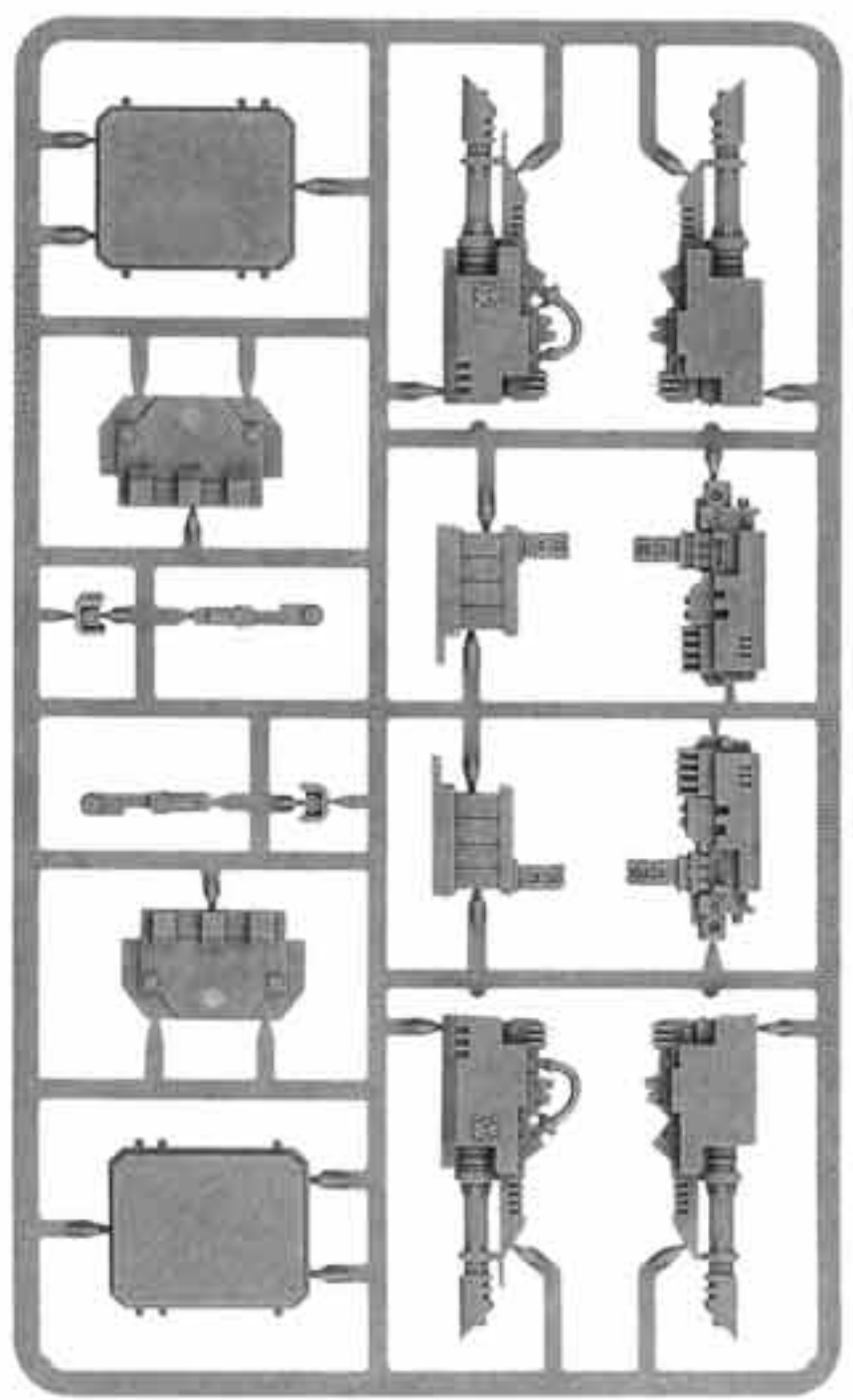

PREDATOR SPONSONS
99390199008

All miniatures are supplied unpainted. Models, bits, and sprues are all shown actual size unless otherwise noted. Contents may vary slightly from those shown.

HEAVY SUPPORT



Chaos Dreadnought Box (1)
99110102003



**CHAOS DREADNOUGHT
POWER CLAW**
9947010200313

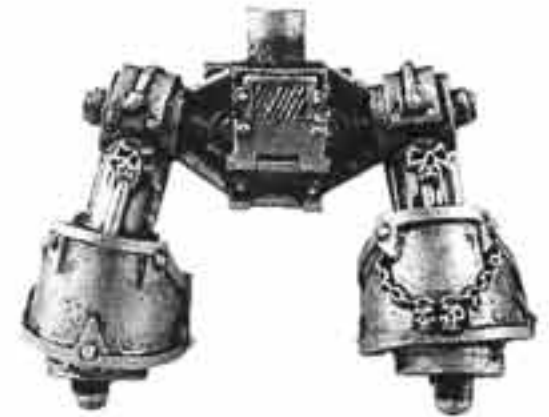

CHAOS DREADNOUGHT LEGS
9947010200302



**CHAOS DREADNOUGHT
POWER SCOURGE**
9947010200312

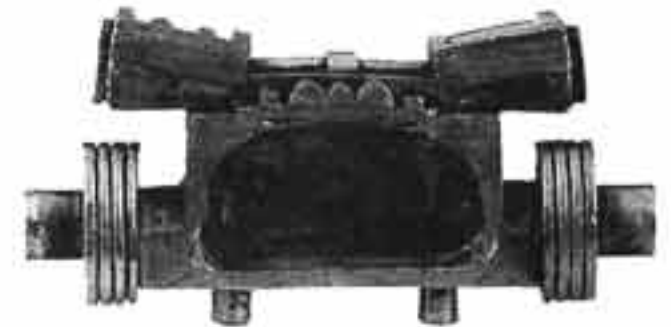

**CHAOS DREADNOUGHT
REAR BODY**
9947010200303



**CHAOS DREADNOUGHT
ASSAULT LAUNCHER**
9947010200308



**CHAOS DREADNOUGHT
POWER PLANT**
9947010200305



**CHAOS DREADNOUGHT
FOOT**
9947010200306



**CHAOS DREADNOUGHT
TROPHY RACK**
9947010200307



**CHAOS DREADNOUGHT
LOWER BODY**
9947010200304

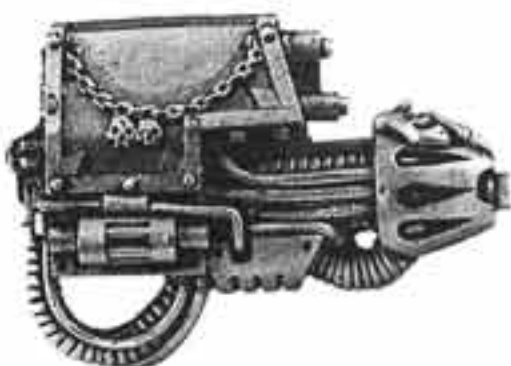

**CHAOS DREADNOUGHT
HEAVY PLASMA GUN**
9947010200309



**CHAOS DREADNOUGHT
TWIN-LINKED AUTOCANNON**
9947010200310

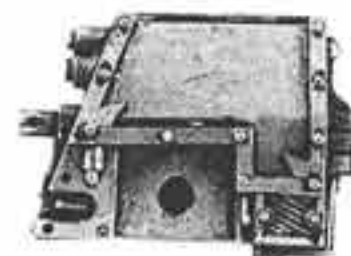

**CHAOS DREADNOUGHT
LEFT SHOULDER**
9947010200311



**CHAOS DREADNOUGHT
SARCOPHAGUS**
9947010200301



HEAVY SUPPORT



Chaos Havoc w/ Heavy Bolter Blister (1)
99060102078

 *Chaos Havoc w/ Heavy Bolter is available only via Special Offer.*

Chaos Havoc Squad Box (5)
99110102074

Chaos Havoc w/ Missile Launcher Blister (1)
99060102079

Chaos Havoc w/ Lascannon Blister (1)
99060102076

Chaos Havoc w/ Auto Cannon Blister (1)
99060102077

The Chaos Havoc Squad comes with the Chaos Space Marine Accessory Sprue (99380102005) shown in Troops as well as the Chaos Space Marine Decal Sheet (99510102002), the Chaos Backpack Sprue (99390102003), and the Chaos Space Marine Sprue (99380102004) shown in Elites.



CHAOS HAVOC HEAVY BOLTER ARM
9947010207803



CHAOS HAVOC CHAMPION ARM
9947010207403



CHAOS HAVOC HEAD 1
9947010207404



CHAOS HAVOC HEAD 2
9947010207405



CHAOS HAVOC BODY
9947010207801



CHAOS HAVOC BACKPACK
9947010207406



CHAOS HAVOC CHAMPION LEGS
9947010207402



CHAOS HAVOC CHAMPION TORSO
9947010207401



CHAOS HAVOC AUTOCANNON ARM
9947010207408



CHAOS HAVOC MISSILE LAUNCHER ARM
9947010207412



CHAOS HAVOC LASCANNON ARM
9947010207410



CHAOS HAVOC HEAVY BOLTER
9947010207802



CHAOS HAVOC AUTOCANNON
9947010207407



CHAOS HAVOC MISSILE LAUNCHER
9947010207411



CHAOS HAVOC LASCANNON
9947010207409

All miniatures are supplied unpainted. Models, lists, and sprues are all shown actual size unless otherwise noted. Content may vary slightly from those shown.



HEAVY SUPPORT



The Death Guard Havocs come with the Chaos Space Marine Accessory Sprue (99380102005) shown in Troops as well as the Plague Marine Body 3 (9947010208304), Plague Marine Sergeant Bolter & Backpack (9947010208310-11), and Plague Marine Plague Knife 3 (9947010208317) shown with the Plague Marines and the Chaos Space Marine Sprue (99380102004) shown with the Emperor's Children.

Death Guard Havoc Box (5)
99110102090
Death Guard Havoc Blister (Random 2)
99060102091



**HAVOC HEAD
SPRUE 1**
9947010209002



**HAVOC HEAD
SPRUE 2**
9947010209003

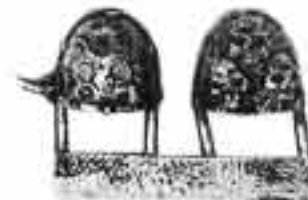

**HAVOC SHOULDER
PAD SPRUE 1**
9947010209004



**HAVOC SHOULDER
PAD SPRUE 2**
9947010209005



HAVOC BODY
9947010209101



**HAVOC ACCESSORY
SPRUE**
9947010209001



HAVOC TORSO 1
9947010209006



HAVOC TORSO 2
9947010209007



HAVOC TORSO 3
9947010209008



HEAVY SUPPORT

The Chaos Defiler comes with the Chaos Tank Accessory Sprue 2 (99390102004) shown with the Chaos Rhino in HQ.

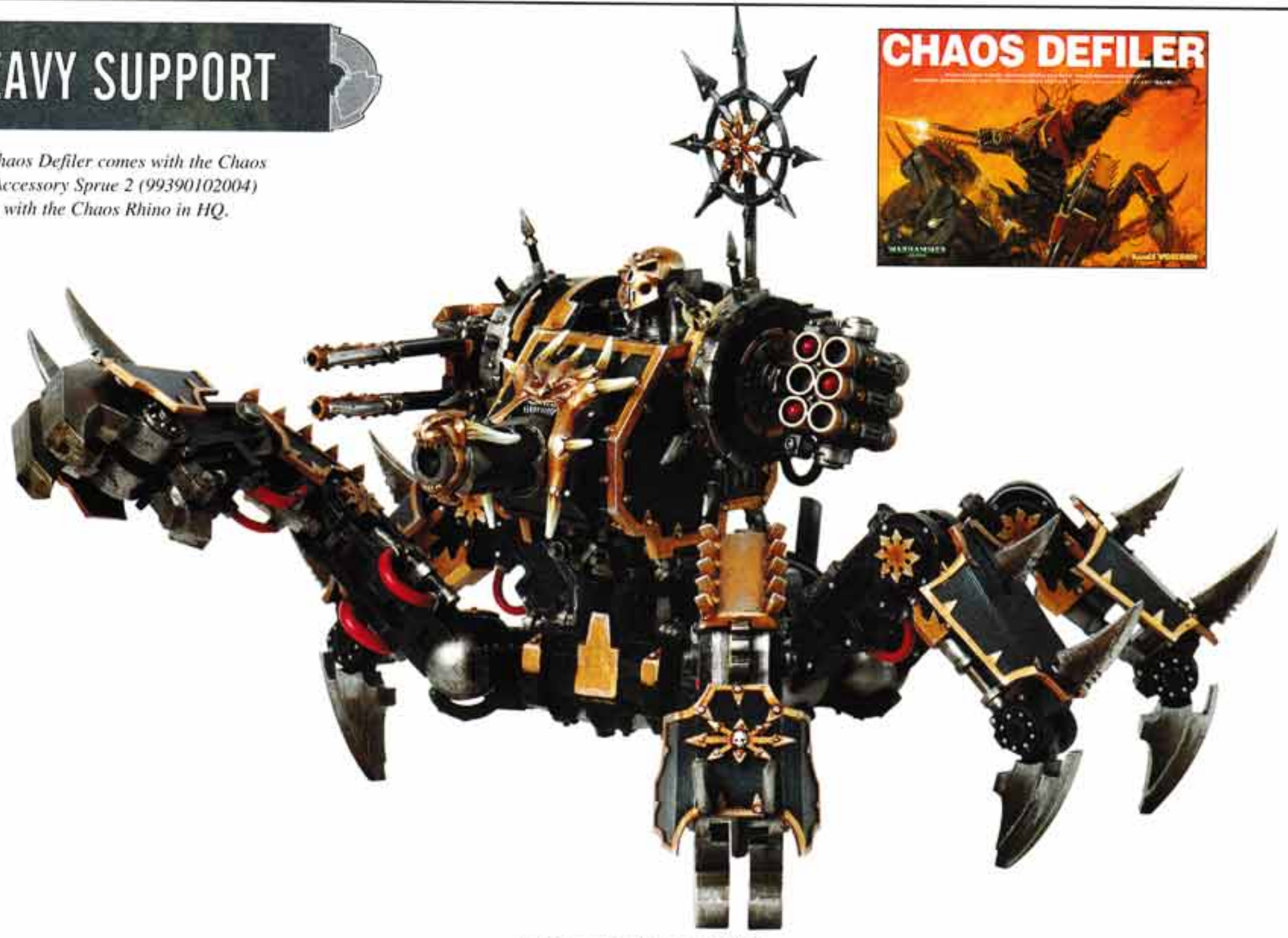

Chaos Defiler Box (1)
99120102013

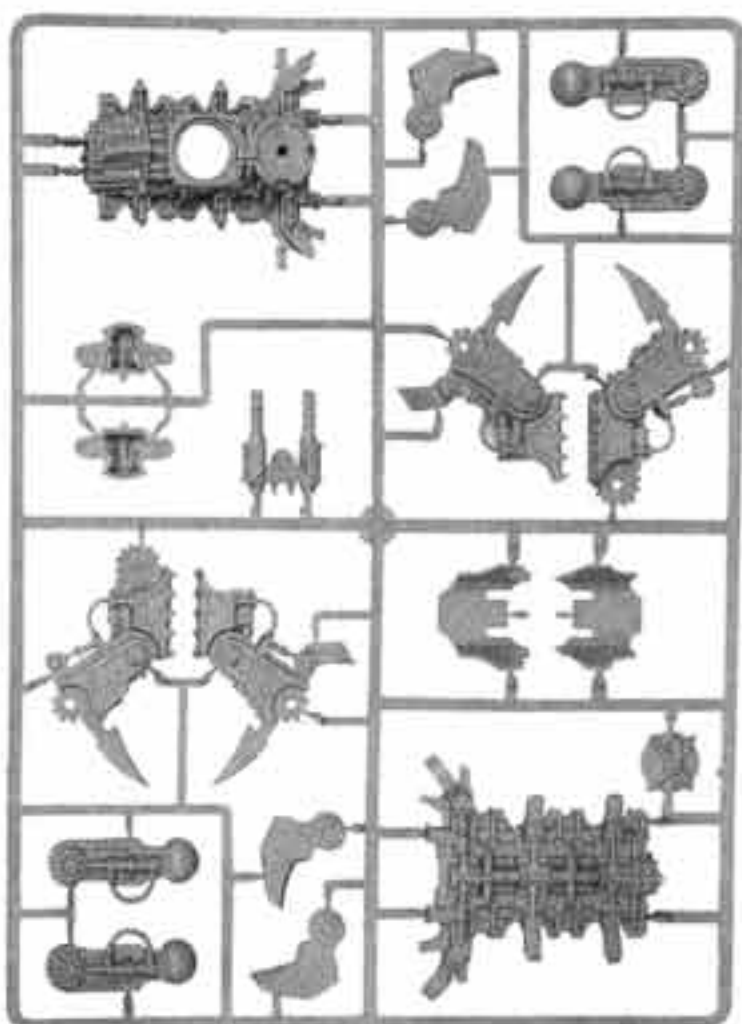

DEFILER BODY SPRUE (SHOWN 30% ACT. SIZE)
99390102005

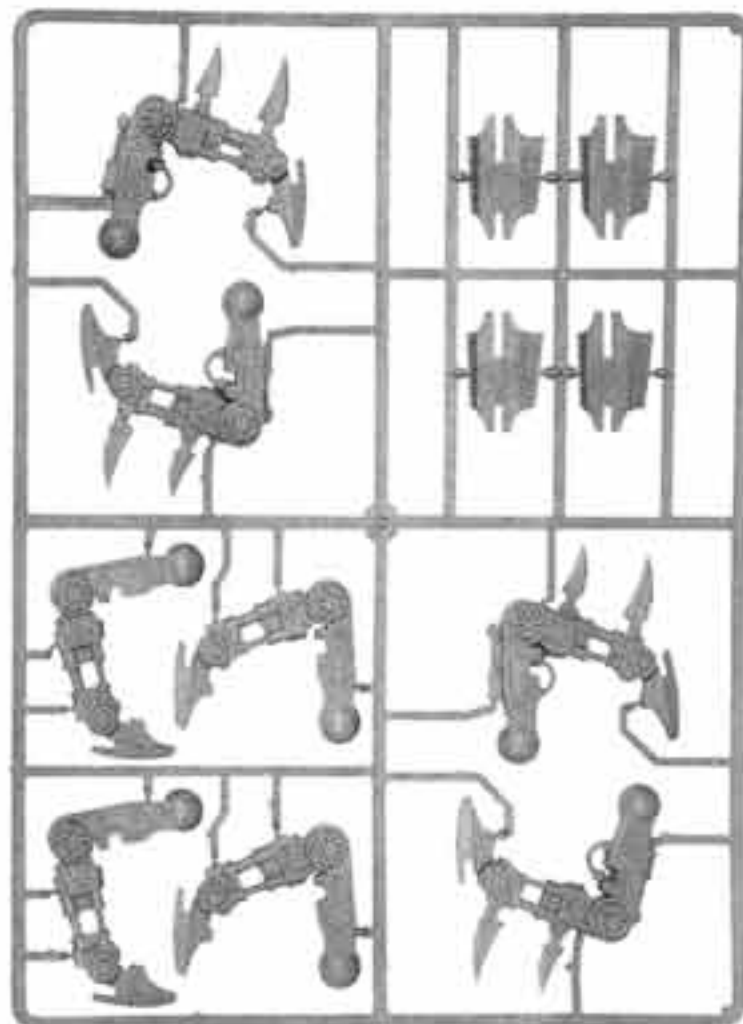

DEFILER LEGS SPRUE (SHOWN 30% ACT. SIZE)
99390102006

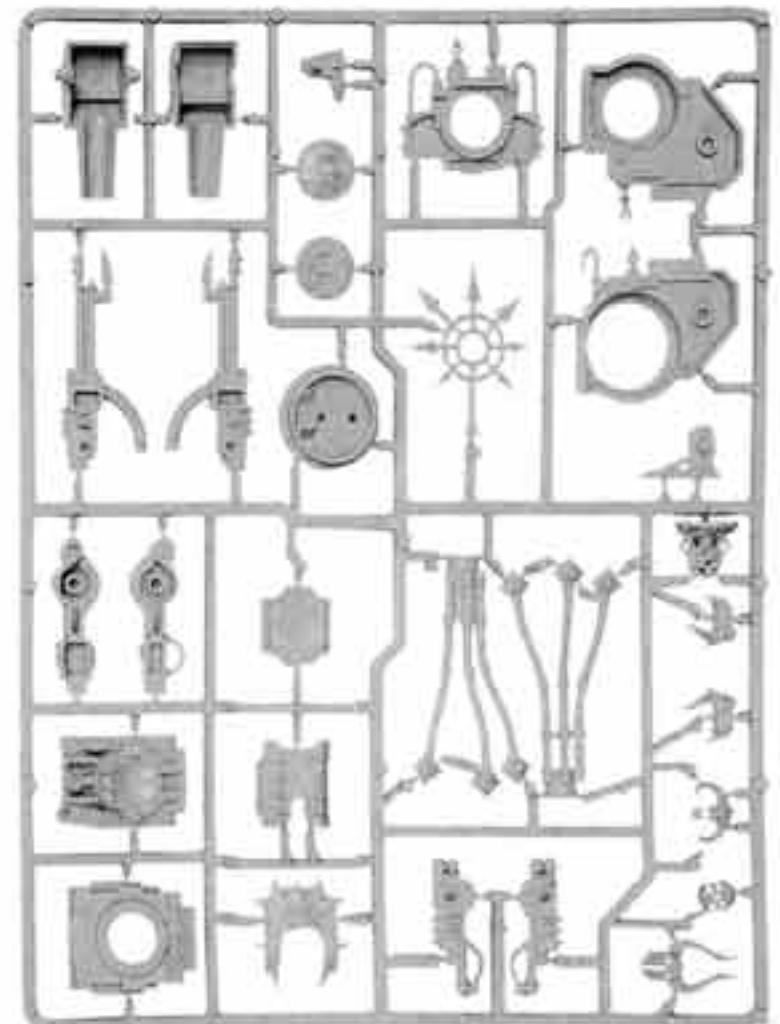

DEFILER WEAPONS SPRUE (SHOWN 30% ACT. SIZE)
99390102007

All measurements are supplied approximate. Models, kits, and sprues are all shown against a plain white background. Contents may vary slightly from those shown.

TACTICS

TIPS FOR WINNING WITH CHAOS SPACE MARINES



- A. An army such as an Alpha Legion army with three Havoc squads and three Chosen squads can field an incredible number of heavy weapons that can also *Infiltrate*. Add a Bloodthirster and some Bloodletters for close-combat support, and this army can be very difficult to deal with in many games.
- B. A Night Lords army can field four units of Raptors. In general, these fast-moving assault specialists can break large units of enemy troops in close combat or use the *Hit & Run* ability to expose a particular target in the Shooting Phase. In a Night Lords force, the Raptors gain even more utility in a mission that uses the *Night Fighting* rules, since all Night Lords have *Acute Senses*.
- C. The Word Bearers are renowned for using large numbers of Daemons. Chaos Bikers can zoom forward with the *Turbo Boost* ability and use icons to summon the army's Daemons practically on top of the enemy lines, where your opponent least expects it! Other units such as Raptors and Possessed with the *Daemonic Flight* upgrade can also be used to cross the table quickly and place their Icons in locations where the Daemons will be the most disruptive to your opponent's plans. In total, Word Bearers could have up to nine Troops units, such a large number of Daemons would be hard for most armies to deal with.



COUNTERTACTICS

TIPS FOR FIGHTING AGAINST CHAOS SPACE MARINES

- A. *Infiltrate* is not used in all missions, but it does show up in most. Some wargear will help when facing armies with lots of *Infiltrators* – the auspex, surveyor, and chooser of the slain come to mind. During deployment, you can spread out your units such that they can see most of the board – that way, the *Infiltrators* will have to be placed over 18" from your units. Lastly, you can use *Infiltrators* of your own to limit the places the enemy can deploy his units. When the Daemons are finally summoned, units that can *Deep Strike* can fill gaps in your line that the Daemons might otherwise exploit.
- B. Close combat specialists of your own can usually handle Raptors in assault, although you'll want to make sure backup is handy. *Fearless* units or units with high Leadership and the ability to reroll failed Morale Checks can withstand the initial charge, although this approach will usually give the Raptors the opportunity to use their *Hit & Run* ability. One alternative is to leave a unit with low Leadership (or one with the ability to reroll successful Morale Checks) out in front to receive the Raptors' assault and then fall back (not very unlikely thanks to the Raptors' *Daemonic Visage*), leaving the Raptors open to your own shooting!
- C. Psycannons (which ignore invulnerable saving throws) can deal handily with *Turbo Boosting* bikers. In addition, if you can pour enough firepower into the bikes you can potentially eliminate them all and stop the Daemons from being summoned onto the board so close by. Since the bikes will be trying to get very close to you, you will usually be in range for rapid fire! If a Word Bearer army does take nine units of Daemons, it is allowed only two selections each of Elites, Fast Attack, and Heavy Support. In the 1st turns of the game, you should outnumber the Word Bearers that are currently on the table (provided you aren't waiting for your own Daemons, *Reserves*, or *Deep Striking* units). Again, wiping units out should be a priority to limit Daemonic summoning. In addition to scoring Victory Points for the destruction of a unit, you will also get Victory Points for the Daemons being off-table at the end of the game.





COLORS OF WAR

KEY

■ Top Box(es): Basecoat Colors & Ink Washes ■ Bottom Box(es): Highlights ■ Mixed Colors



WORLD EATERS
Red Gore, Dwarf Bronze
Blood Red, Burnished Gold



WORD BEARERS
Boltgun Metal, Scab Red
Mithril Silver, Scab Red & Skull White



ALPHA LEGION
Midnight Blue, Goblin Green
Regal Blue, Scorpion Green



NURGLE
Catachan Green, Red Gore
Camo Green, Rotting Flesh

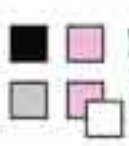

EMPEROR'S CHILDREN
Chaos Black, Tentacle Pink
Fortress Grey, Tentacle Pink & Skull White



IRON WARRIORS
Brazen Brass, Dwarf Bronze
Chainmail, Shining Gold



THOUSAND SONS
Regal Blue, Golden Yellow
Enchanted Blue, Bad Moon Yellow



BLACK LEGION
Chaos Black, Boltgun Metal
Shadow Grey, Mithril Silver



NIGHT LORDS
Regal Blue, Scab Red
Enchanted Blue, Blood Red



WARP GHOSTS
Chaos Black, Kommando Khaki
Shadow Grey, Bleached Bone



VIOLATORS
Ultramarines Blue, Boltgun Metal
Ice Blue, Chainmail



THE DAMNED COMPANY OF LORD CAUSTOS
Codex Grey, Purple Ink
Fortress Grey, Shining Gold



THE PYRE
Chaos Black, Blazing Orange
Shadow Grey, Golden Yellow



CHILDREN OF PURGATOS
Snot Green, Brazen Brass
Scorpion Green, Shining Gold

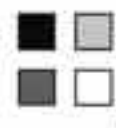

SONS OF MALICE
Chaos Black, Fortress Grey
Codex Grey, Skull White

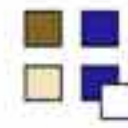

EXTINCTION ANGELS
Snakebite Leather, Liche Purple
Bleached Bone, Liche Purple & Skull White

All miniatures are supplied unpainted. Models, bits, and sprues are all shown actual size unless otherwise noted. Colors may vary slightly from those shown.

SHOWCASE



Left: Mark Mosler's Nurgle Terminator Lord won third place in the Warhammer 40,000 Single Miniature category at the 2004 Baltimore Golden Demon painting competition.

Above: Andrew Muir's Typhus won first place in the Youngbloods category at the 2004 Atlanta Golden Demon painting competition.



Above: Frederick Casler won second place in the Warhammer 40,000 Vehicle category with his Chaos Dreadnought of Nurgle at the 2004 Atlanta Golden Demon painting competition.



Left and Below: Troy Clifton won first place in the Warhammer 40,000 Squad category with his Defense of Prospero at the 2004 Atlanta Golden Demon competition.





SHOWCASE



Right: Vlad Fayershteyn won third place in the Warhammer 40,000 Large Model category with his Daemon Prince at the 2004 LA Golden Demon painting competition.

Right: Adam Catt won second place with his Daemon Prince in the Warhammer 40,000 Large Model category at the 2004 Chicago Golden Demon painting competition.



Right: Howard Samber's Horus was a runner-up at the 2004 LA Golden Demon painting competition.

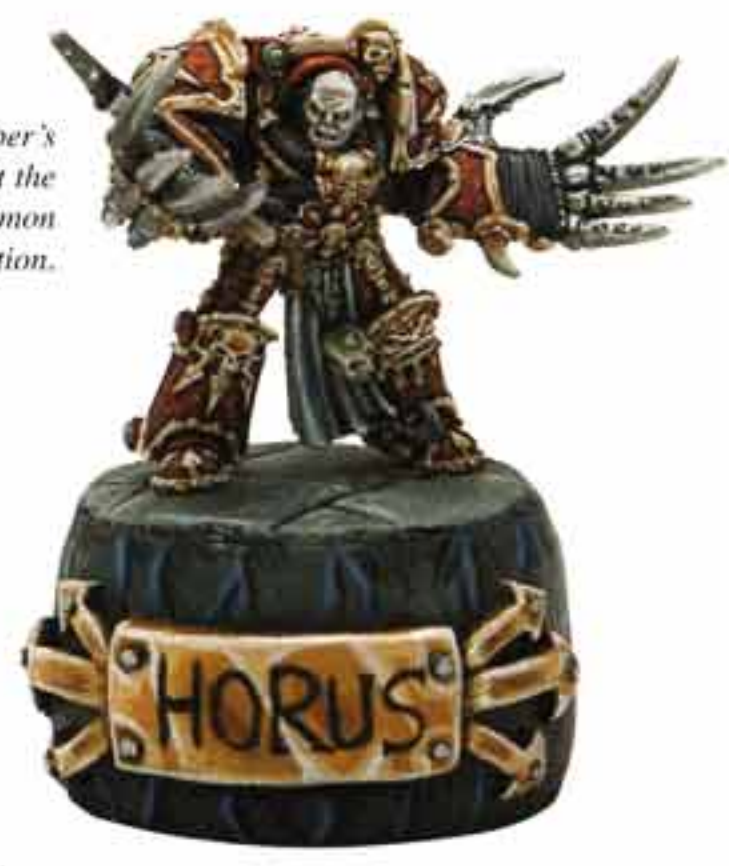

Left: Allan Carrasco won second place in the Warhammer 40,000 Vehicle category with his Possessed Nurgle Dreadnought at the 2003 UK Golden Demon painting competition.



Above: Allan Iano's Typhus won second place in the Youngbloods category at the 2004 Baltimore Golden Demon painting competition.



Above: Brian Hotovec's Word Bearers Champion was a runner-up at the 2004 Chicago Golden Demon painting competition.



SHOWCASE

Below: Dragomir Chris Milanovic won second place with his Death Guard Rhino in the Warhammer 40,000 Large Vehicle category at the 2004 Canadian Golden Demon painting competition.



Above Right: Stéphane Giraud's Emperor's Children Terminator was a runner-up at the 2004 French Golden Demon painting competition.



ALTERNATE MODEL – TROOPS
Chaos Space Marines

COMPONENTS FOR 4 COMPLETE MODELS

- 99380102004 Chaos Space Marine Sprue
- 99380201014 Chaos Warrior Sprue
- 99390102003 Chaos Space Marine Pack

COMPLEXITY RATING



ALTERNATE MODEL – ELITES
Chaos Terminators

COMPONENTS FOR 5 COMPLETE MODELS

- 99380101020 Terminator Sprue A
- 99380101021 Terminator Sprue B
- 9947010207306 Thousand Sons Torso 1 (x5)
- 9947010207503 Obliterator Body 1 (x3)
- 9947010207505 Obliterator Body 1 (x2)
- 9947010206708 Iron Warrior Head 4 (x5)
- 9947010200215 Term. Combi-Bolter 2 (x5)
- 9947010200219 Term. Power Fist (x5)

COMPLEXITY RATING



Above: Jason Richards won second place with his Phykus the Polluted in the Warhammer 40,000 Single Miniature category at the 2004 Canadian Golden Demon painting competition.

All miniatures are supplied unpainted. Models, lists, and options are all shown actual size unless otherwise noted. Contents may vary slightly from those shown.



DARK ELДАР



Special Offer
Only Section

The bladed and sleek Reaver Jetbikes hovered several feet above the roof of the partially collapsed building. Hissrex could feel her bike's powerful anti-gravitic motor thrum and purr beneath her skin-tight gauntlets. The machine was gently pulling at the tethers that held the Jetbike in place. The signal to attack would come soon, and the squad knew its mission was to take out the Ork artillery before the battle started. The Cabal of the Rending Talon could not afford to have its Raiders shot out of the sky. Without a word, the Succubus gave the hand signal. In one fluid motion, all ten of the Jetbikes slipped off their tethers and glided downward in single file. Their approach up a side street of the crumbling city was unchecked. In perfect unison, each rider thumbed the turbo-boosters and sent their machines rocketing over the rubble barriers the Orks had created. Soon, thought Hissrex, the wild joy of the combat drugs would kick in, and the bloodshed would begin.

Among the mysterious race of the Eldar, there are those especially bloodthirsty raiders who have come to be known as the Dark Eldar. Little is known about these debased cousins of the Eldar. Striking without warning, they are well known for piratical raids, and it is rumored that these hit and run attacks are staged to capture prisoners and fresh victims for never-ending tortures back in the twisted Dark Eldar realm. Where Dark Eldar come from and how they came to be this way is largely unknown, but it is assumed that the only thing worse than being killed by these alien raiders is being taken alive by them.

Fighting Style

Dark Eldar are fragile but deadly foes. Their razor sharp attacks can quickly decapitate their enemies before they know what hit them. Capable of lightning-fast raids, the Dark Eldar rely on their speed and anti-gravitic hover vehicles to launch wicked assaults or to get into position to pour massed firepower into an overwhelmed foe. Although vicious in the extreme, Dark Eldar cannot stand for long in a firefight, and their numbers are too few to engage in a battle of attrition.

Using Raider transports and sophisticated weaponry, successful Dark Eldar players need to concentrate their attacks and negate a threat before it has time to respond. The hovering torture device known as a Talos can absorb some punishment, and a Dark Eldar Lord with a retinue

Noel Meyer was a runner-up at the 2004 Chicago Golden Demon Painting Competition.

of Incubi can deliver serious damage. However, the rest of the army is fragile, and your enemies will know it! Dark Eldar offer players a unique challenge. In the hands of a master, the army is swift and ruthless, but as many careless aspiring Dark Eldar Raiders have discovered, the army is unforgiving to tactical blunders.

Collecting a Dark Eldar Army

A good way to start a Dark Eldar army is to collect the compulsory squads from the Standard Missions Organization Chart. Select two core Troops squads and an HQ choice. These selections will also give starting players a great small army to get started. Warrior squads offer a lot of firepower, especially when one or two of the Warriors are equipped with dark lances (for attacking vehicles) or splinter cannons (for attacking squads). Raider squads are also a Troops choice. Although smaller in maximum size than the Warrior Squad, the added mobility of the Raider transport adds not only speed to the squad but another heavy weapon as well. A Dark Eldar Lord is a fearsome close combat monster with access to loads of specialized upgrades from the Dark Eldar Armory.

When a Dark Eldar player is ready to enlarge his army, a great first expansion is a retinue for his Dark Lord. A retinue may be composed of Incubi, wicked followers who are equipped with power armor and

vicious hand-to-hand weaponry. Other great additions are Wyches, who are lightly armored hand-to-hand troops who have access to deadly combat drugs and a wide selection of gladiatorial weapons. Dark Eldar have two great Fast Attack options to rock foes back on their heels: Reaver Jetbikes and Hellions. For Heavy Support, the fallen Eldar use the black-pinioned Scourges, the heavily equipped Ravagers, or the menacing Talos. The Dark Eldar are full of unique choices, and in the end, each player will need to personalize his army with squads and wargear that fit into a preferred strategy or style of play. Start your own terror-causing rampage across the galaxy today!

Marika Reimer entered this Dark Eldar Wych in the 2004 Chicago Golden Demon Painting Competition.

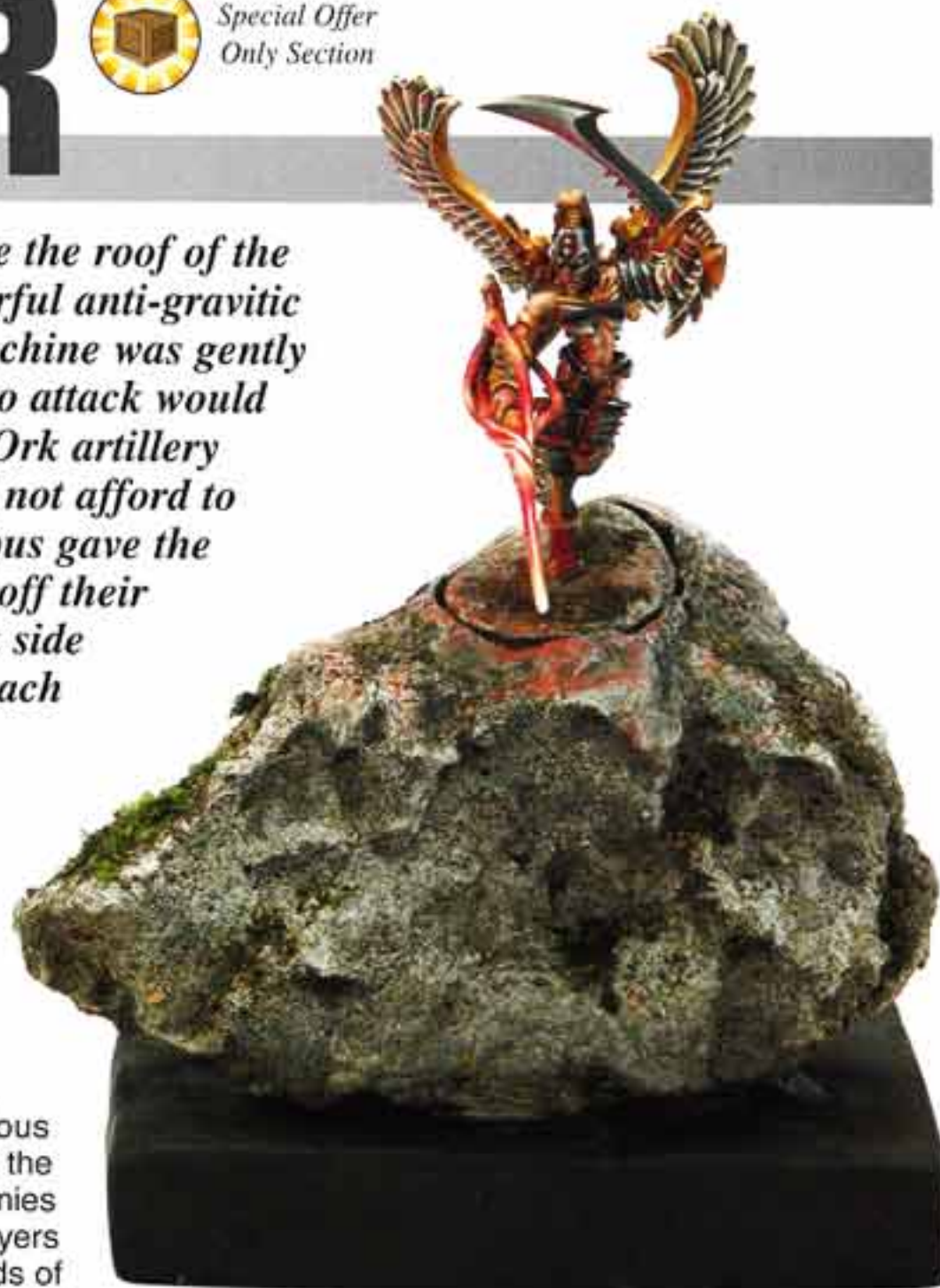

Bryan Shaw's Drazhar won second place at the 2004 Los Angeles Golden Demon Painting Competition.



Dark Eldar Battleforce Box 99120112001

- 20 Dark Eldar Warriors
- 5 Dark Eldar Reaver Jetbikes
- 1 Dark Eldar Raider
- Warhammer 40,000 Jungle Trees



GETTING STARTED



This 48-page rulebook contains painting and modeling guides, background, and the full rules for fielding a force of the Dark Eldar.

Codex:
Dark Eldar
60030112001



HAEMONCULUS 1
9947011200301

HAEMONCULUS 2
9947011200302

Haemonculus Blister (Random 1)
99060112003



DARK ELGAR LORD ARM
9947011200902



DARK ELGAR LORD BODY
9947011200901



HQ



DARK ELGAR LORD (FEMALE)
9947011202601



DARK ELGAR LORD

Dark Eldar Lord Blister (Random 1)
99060112009



**Lelith Hesperax,
Wych Lord Blister (1)**
99060112032



LELITH HESPERAX BODY
9947011203201



**LELITH HESPERAX
IMPALER**
9947011203202



**Urien Rakarth, Master
Haemonculus Blister (1)**
99060112007

**BIT NAME: URIEN RAKARTH,
MASTER HAEMONCULUS**
BIT CODE: 9947011200701



**Kruellagh the
Vile Blister (1)**
99060112029

**BIT NAME: KRUELLAGH
THE VILE**
BIT CODE: 9947011202901



LELITH HESPERAX FOOT
9947011203203



LELITH HESPERAX SPIKES
9947011203204



HQ



DRAZHAR LEFT ARM
9947011202702



DRAZHAR RIGHT ARM
9947011202703



DRAZHAR BACKPACK
9947011202704



DRAZHAR BODY
9947011202701



Drazhar, Incubi Master
Available as Bitz Only



Incubi w/ Assault Weapon Blister (Random 1)
99060112010



INCUBUS SHREDDER
9947011201003



INCUBUS BLASTER
9947011201004



INCUBUS W/ ASSAULT WEAPON 1
9947011201001



INCUBUS W/ ASSAULT WEAPON 2
9947011201002



Incubi Blister (Random 2)
99060112006

The Incubi Blister is a random assortment of two Incubus bodies and two Incubus backpacks, shown below.



INCUBUS BACKPACK 1
9947011200605



INCUBUS BACKPACK 2
9947011200606



INCUBUS BACKPACK 3
9947011200607



INCUBUS 1
9947011200601



INCUBUS 2
9947011200602



INCUBUS 3
9947011200603



INCUBUS 4
9947011200608



INCUBUS 5
9947011200609

All miniatures are supplied unpainted. Models, bits, and sprues are all shown actual size unless otherwise noted. Contents may vary slightly from those shown.



Asdrubael Vect Box (1)
99140112030

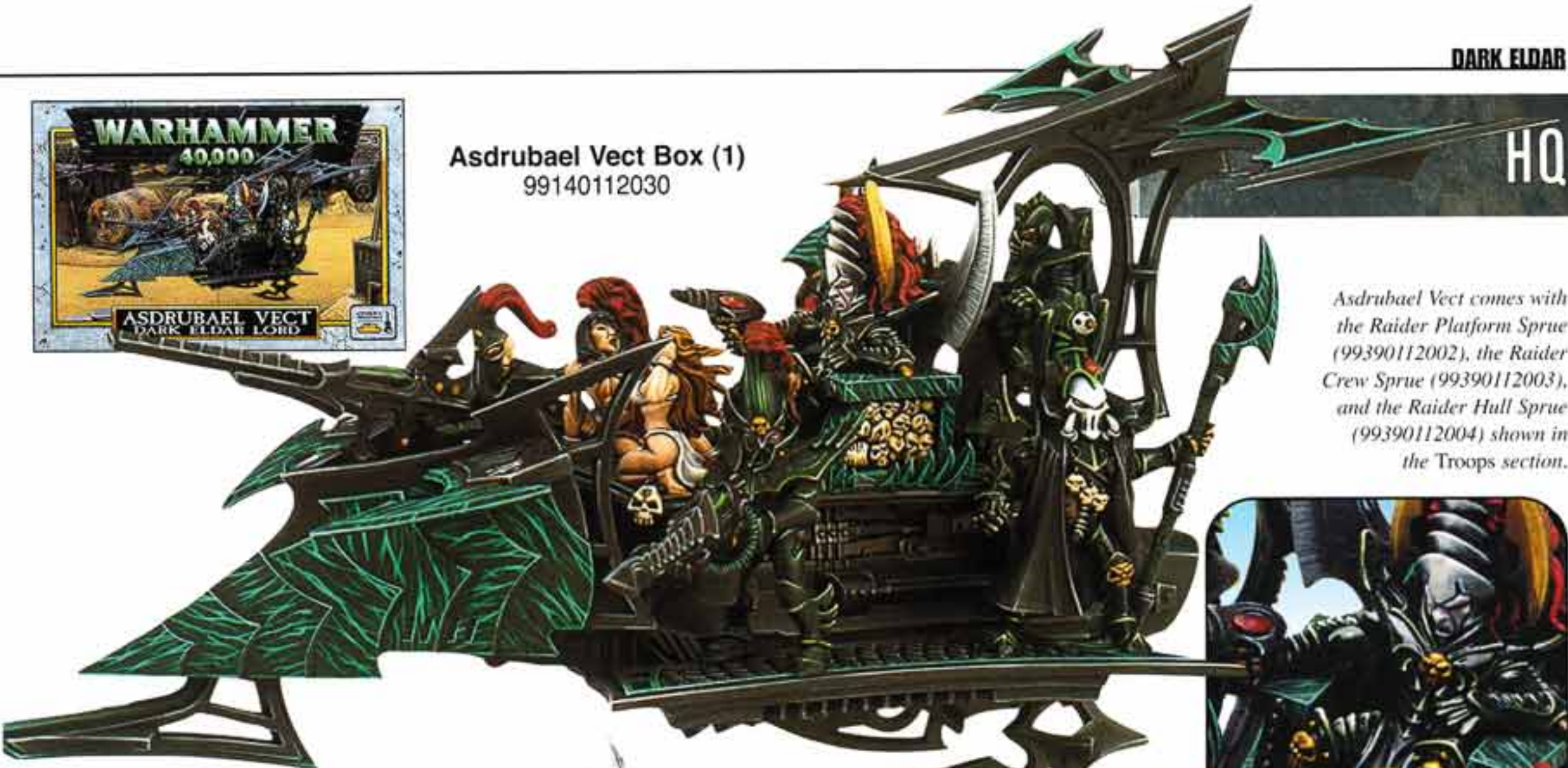

Asdrubael Vect comes with the Raider Platform Sprue (99390112002), the Raider Crew Sprue (99390112003), and the Raider Hull Sprue (99390112004) shown in the Troops section.



BODYGUARD 1 BODY
9947011203002



BODYGUARD 2
9947011203004



WEAPON MOUNT
9947011203007



VECT THRONE SEAT
9947011203021



VECT THRONE BACK
9947011203014

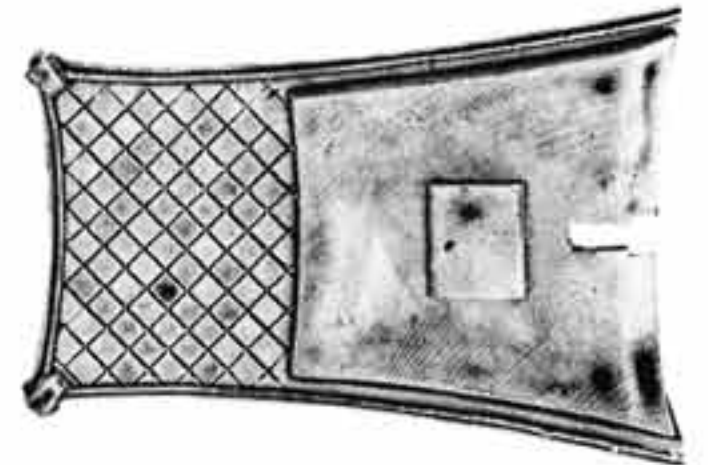

VECT PLATFORM
9947011203001



GUNNER 1
9947011203008



GUNNER 2
9947011203009



INCUBI BACKPACK
9947011203020



GUNNER ARMS
9947011203011



VECT THRONE LEFT SIDE
9947011203017



VECT THRONE RIGHT SIDE
9947011203018



VECT TORSO
9947011203015



VECT LEGS
9947011203016



BROKEN SPIKES
9947011203005



SPIKES
9947011203006



VECT BODYGUARD 1 PUNISHER
9947011203003



RAVAGER DISINTEGRATOR
9947011203010



VECT RIGHT ARM
9947011203019



SLAVE
9947011203013



PRISONER
9947011203012



ELITES

PAINTING DARK ELDAR FLESH



DWARF FLESH BASECOAT

1. Apply a Dwarf Flesh basecoat. 2. Apply a 50/50 mix of Blue and Chestnut Brown Inks. 3. Add Rotting Flesh to the mix and highlight. 4. Final highlight is straight Rotting Flesh.



PALLID FLESH BASECOAT

1. Apply a Pallid Flesh basecoat. 2. Apply a 75/25 mix of Blue and Chestnut Brown Inks. 3. Add Pallid Flesh to the mix and highlight. 4. Final highlight is Skull White added to the step-3 mix.



SHADOW GREY BASECOAT

1. Apply a Shadow Grey basecoat. 2. Highlight with a 50/50 mix of Shadow Grey and Dwarf Flesh. 3. Apply a second highlight with a 50/50 mix of Shadow Grey and Pallid Flesh. 4. Final highlight is Pallid Flesh.



TANNED FLESH BASECOAT

1. Apply a Tanned Flesh basecoat. 2. Apply a Dwarf Flesh highlight. 3. Apply a highlight of Elf Flesh. 4. Final highlight is Pallid Flesh.

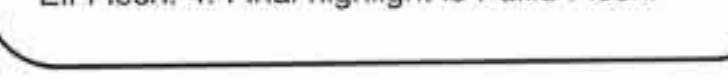

Wych w/ Wych Weapon Blister (Random 1) 99060112018



WYCH W/ FALCHION RAZOR 1
9947011201808



WYCH W/ FALCHION RAZOR 2
9947011201809



WYCH W/ HYDRA KNIVES 1



WYCH W/ SHARDNET 1



WYCH W/ HYDRA KNIVES 2
9947011201806



WYCH W/ SHARDNET & IMPALER 2
9947011201805

Mandrakes are the most malevolent of the Dark Eldar, preying on their own kind from the shadows of Commorragh. Who can say how a Dark Eldar Lord can entice these vile creatures to serve him in battle?



WYCH W/ HYDRA KNIVES 1 BODY
9947011201801



WYCH W/ SHARDNET 1 IMPALER ARM
9947011201804



MANDRAKE 1
9947011202301



MANDRAKE 2
9947011202302



WYCH W/ SHARDNET 1
9947011201803



WYCH W/ SHOULDER 6
9947011201807



MANDRAKE 3
9947011202303



MANDRAKE 4
9947011202304



WYCH W/ HYDRA KNIVES 1 ARM
9947011201802



WYCH W/ SHOULDER 7
9947011201810

Mandrakes Blister (Random 3) 99060112023

ELITES



BEASTMASTER
9947011200801

Beastmaster & Warp Beast Blister
(Beastmaster & Random 1 Beast)

99060112037

Warp Beast Blister (Random 2)

99060112005



WARP BEAST 1 BODY
9947011200501



WARP BEAST 2 BODY
9947011200504



WARP BEAST 3 BODY
9947011200507



WARP BEAST 1
FRONT LEG
9947011200502



WARP BEAST 1
HIND LEG
9947011200503



WARP BEAST 2
FRONT LEG
9947011200505



WARP BEAST 2
HIND LEG
9947011200506



WARP BEAST 3
FRONT LEG
9947011200508



WARP BEAST 3
HIND LEG
9947011200509



GROTESQUE 2

GROTESQUE 4

GROTESQUE 1
9947011202101

GROTESQUE 3
9947011202104

Grotesques Blister (Random 3)
99060112021



GROTESQUE 2 BODY
9947011202102



GROTESQUE 4 BODY
9947011202105



GROTESQUE 2 ARM
9947011202103



GROTESQUE 4
RIGHT ARM
9947011202106



GROTESQUE 4
LEFT ARM
9947011202107



ELITES



Dark Eldar Wyches Box (5)
99110112001
Wyches Blister (Random 3)
99060112016



Succubus Blister (1)
99060112017



Ruled over by their Succubi, Wyches spend their entire lives perfecting the skills of gladiatorial combat.



WYCH 3 BODY
9947011200105



WYCH 4 BODY
9947011200107



WYCH 5 BODY
9947011200110



SUCCUBUS BODY
9947011200101



WYCH 3 SHOULDER
9947011200106



WYCH 4 SHOULDER
9947011200109



WYCH 4 GUN ARM
9947011200108



WYCH 5 SHOULDER
9947011200111



SUCCUBUS SHOULDER
9947011200102



WYCH 6 W/ SHREDDER
9947011200112

WYCH 7 W/ BLASTER
9947011200113

WYCH W/ SHREDDER

Wyches w/ Assault Weapons Blister (Random 2)
99060112038



WYCH W/ SHREDDER BODY
9947011200103



WYCH W/ SHREDDER SHOULDER
9947011200104

TROOPS



Dark Eldar Raider Box (1)
99120112003

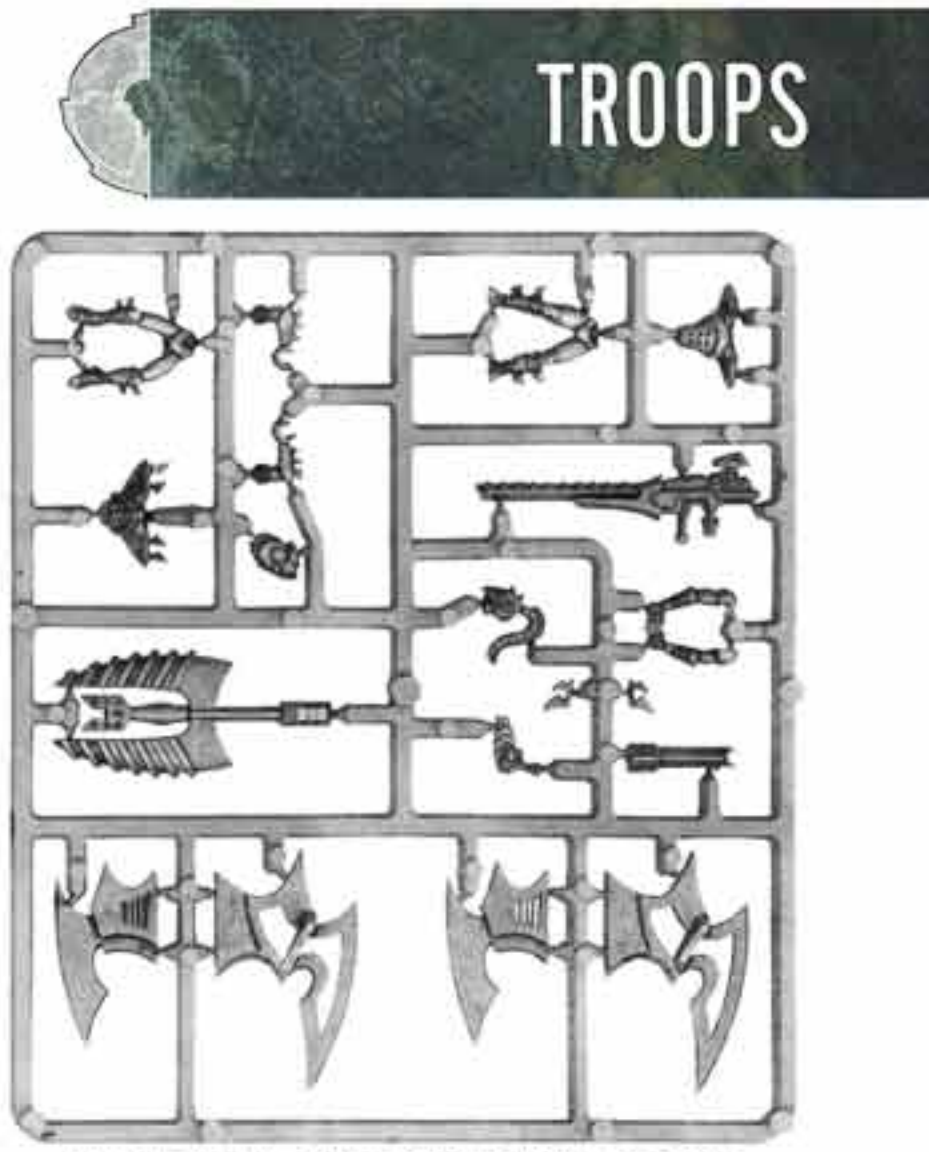

RAIDER CREW SPRUE (SHOWN 50% ACT. SIZE)
99390112003

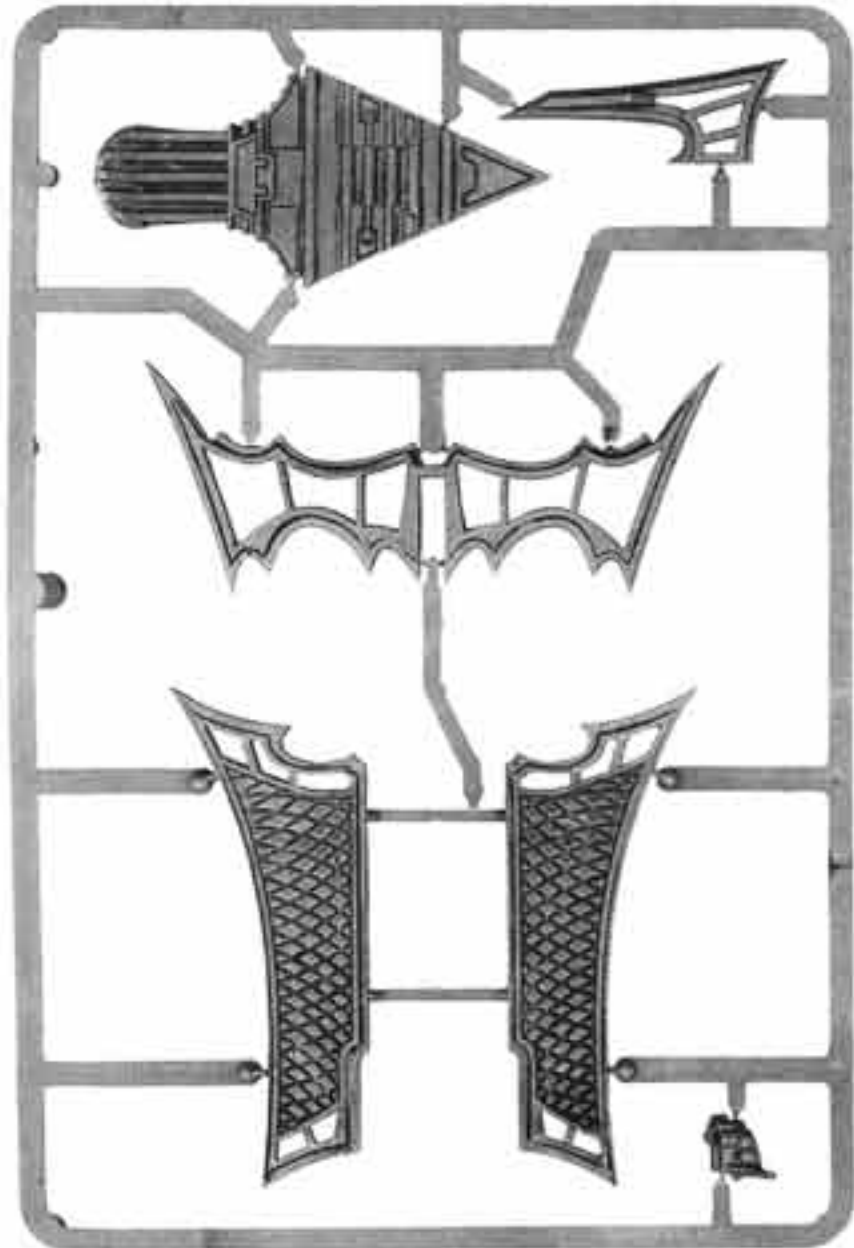

RAIDER PLATFORM SPRUE (SHOWN 50% ACT. SIZE)
99390112002

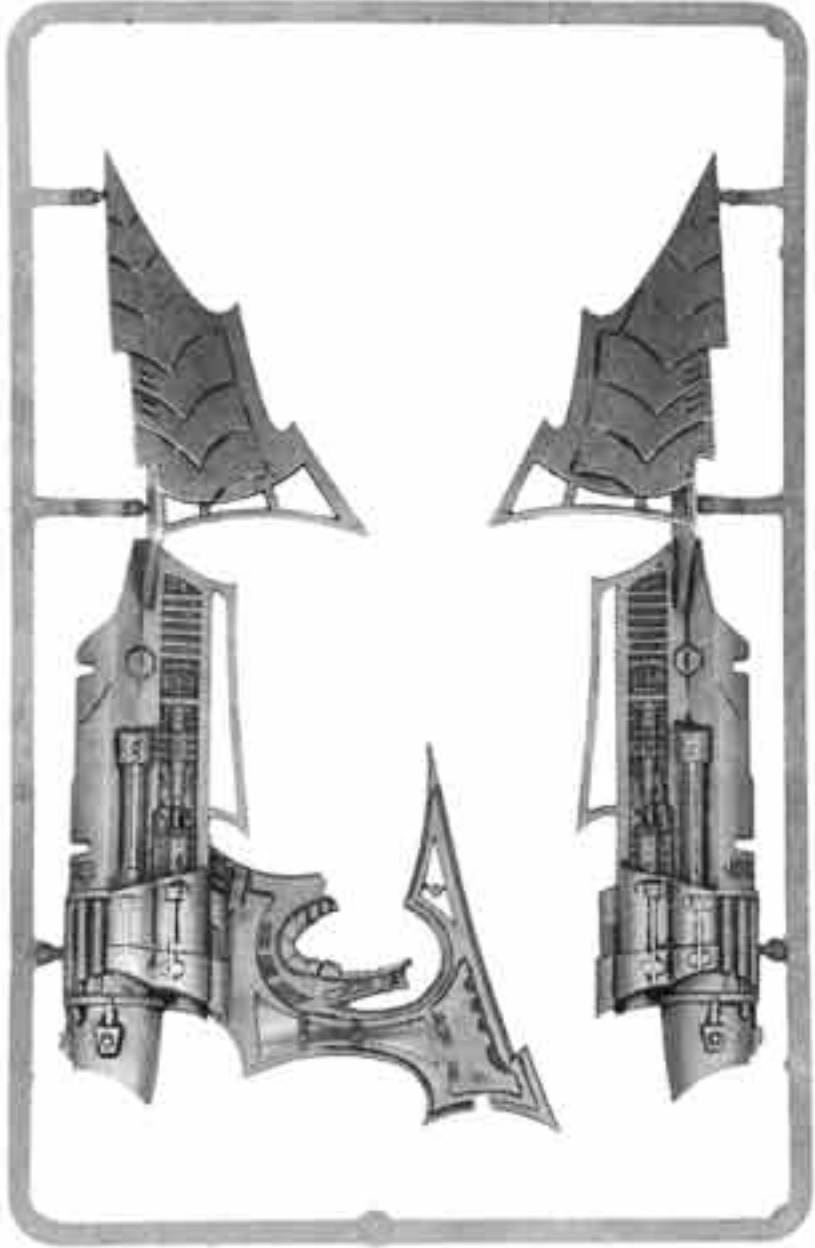

RAIDER HULL SPRUE (SHOWN 50% ACT. SIZE)
99390112004



SYBARITE 1
9947011200201



SYBARITE 2
9947011200202

Sybarite Blister (Random 1)
99060112002

All necessary art supplied unprinted. Models built and printed are all shown in their intended colors. Colors may vary slightly from those shown.



TROOPS



Dark Eldar Warriors Squad Box (16)
99120112002



**DARK ELДАР WARRIOR
BLASTER ARM**
9947011201503



**DARK ELДАР WARRIOR
SHEDDER ARM**
9947011201303



**DARK ELДАР WARRIOR
DARK LANCE ARM**
9947011201403

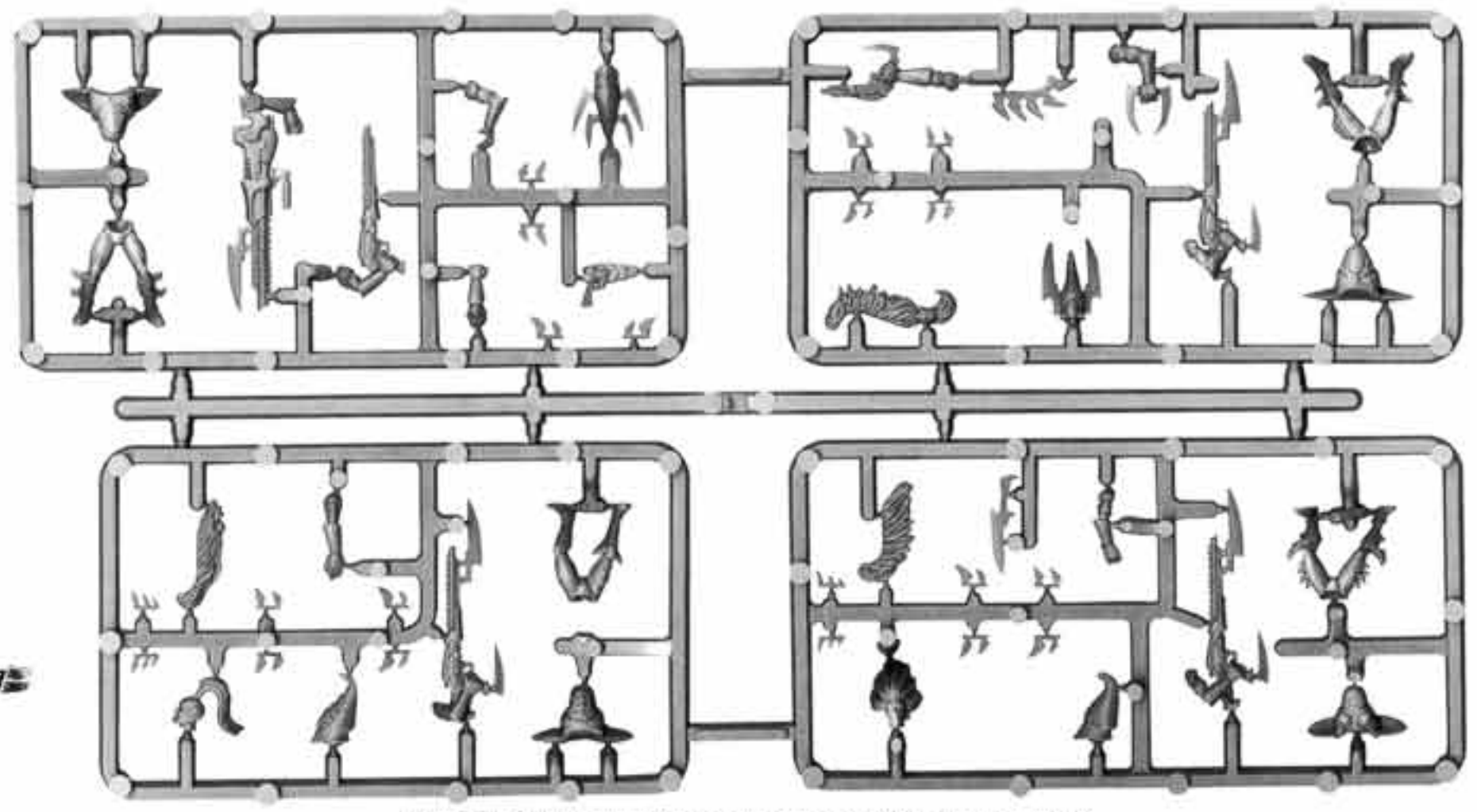

DARK ELДАР WARRIOR SPRUE (SHOWN 50% ACTUAL SIZE)
99380112001 - AVAILABLE ONLY IN WARRIORS SQUAD BOX



**DARK ELДАР WARRIOR
WARRIOR BODY 1**
9947011201301



**DARK ELДАР WARRIOR
WARRIOR BODY 2**
9947011201302



**Dark Eldar Warriors
w/ Dark Lances Blister (2)**
99060112014



**Dark Eldar Warriors
w/ Assault Weapons Blister (2)**
99060112039

All minis are supplied unpainted. Models, bits, and sprues are all shown actual size unless otherwise noted. Contents may vary slightly from those shown.

The Reaver Jetbike is a one-crew vehicle that uses an anti-gravitic impulse engine. The front canopy, rear canards, and keel blade assume various forms. Whether these forms cater to the rider's aesthetic tastes or different battlefield situations is impossible to tell. The Reaver Jetbike is capable of high speeds and fires splinter-like ammunition.

Classified Data:
Adeptus Astartes Dreadnought
Date: 1848576.M41

FAST ATTACK



Reaver Jetbike Squadron Box (3)
Available as Bitz Only

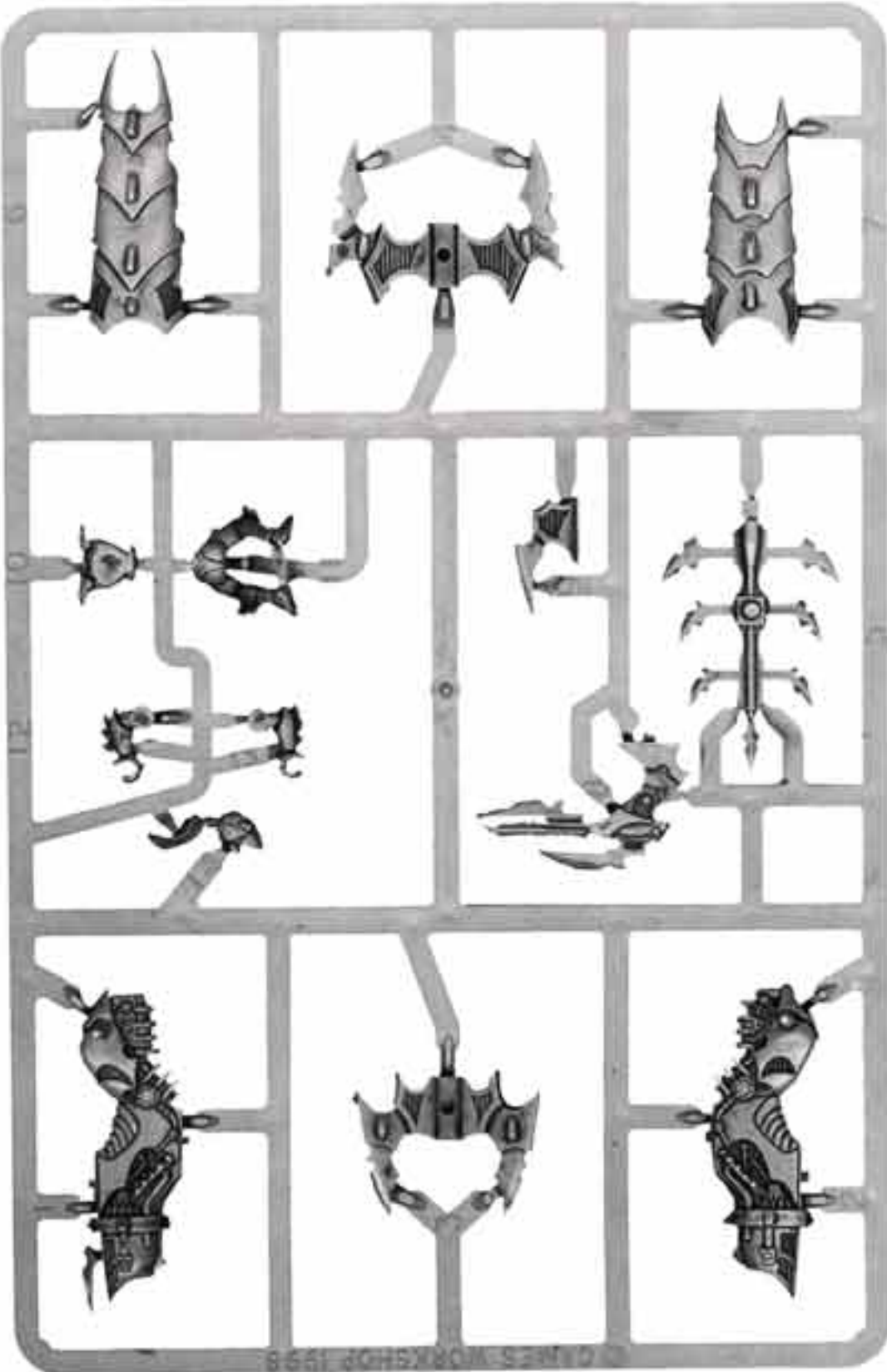

REAVER JETBIKE SPRUE (SHOWN 70% ACT. SIZE)
99390112001



JETBIKE WYCH
TORSO 1
9947011202206



JETBIKE WYCH
TORSO 2
9947011202207



JETBIKE SUCCUBUS
9947011202203



JETBIKE CHAINS
9947011202205



JETBIKE
SUCCUBUS ARM
9947011202204



JETBIKE
WYCH ARM
9947011202208



JETBIKE SHREDDER
9947011202201



JETBIKE BLASTER
9947011202202



FAST ATTACK

RAIDER/RAVAGER PANEL PAINTING



GLYPHS: Pick a glyph you would like to paint and map out where it will be painted. Paint it carefully with Fortress Grey. Highlight the glyph with Skull White. Clean up any jagged lines with the background color. Apply Gloss Varnish to make the glyph stand out.



DIAMONDS: Paint a diamond shape with a 50/50 mix of Vomit Brown and Bleached Bone. Outline the edges with Chaos Black and highlight the diamond by adding more Bleached Bone to your basecoat mix. Apply Gloss Varnish to make it stand out.

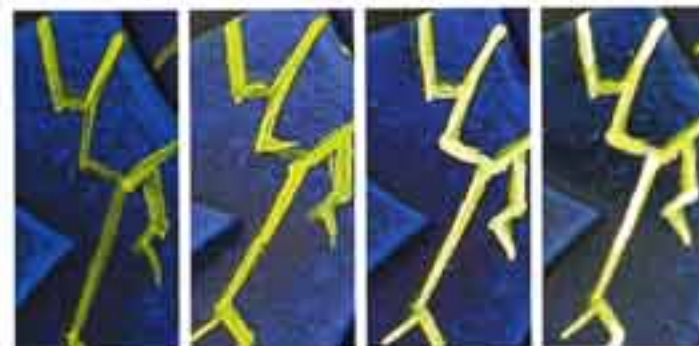

LIGHTNING: Paint your lightning shapes with Sunburst Yellow. Highlight with Bad Moon Yellow. Highlight intersecting areas with a 50/50 mix of Bad Moon Yellow and Skull White. Be sure to leave areas of the previous color showing through. The final, carefully applied highlight is straight Skull White.

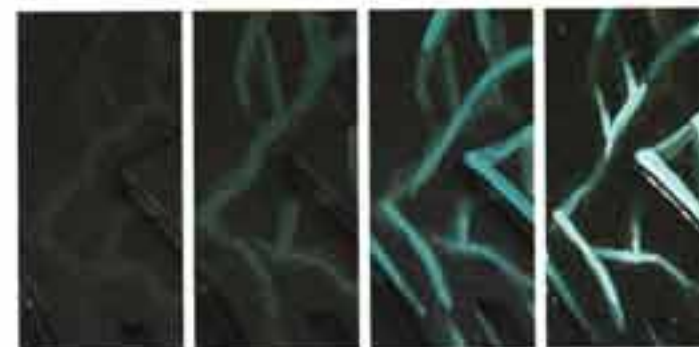

MARBLE: Map out thin lines over black with a 33/33/33 mix of Chaos Black, Dark Angels Green, and Jade Green. Paint thinner lines atop of these lines with more Jade Green to the mix for each successive highlight. The final highlight is a carefully applied thin line of a 50/50 mix of Jade Green and Skull White.



Hellion Blister (Random 1)
99060112031



HELLION BODY 1
9947011203101



HELLION BODY 2
9947011203102



HELLION BODY 3
9947011203103



HELLION HELLGLAIVE 1
9947011203105



HELLION HELLGLAIVE 2
9947011203106



HELLION SKYBOARD
9947011203104



HELLION HELLGLAIVE 3
9947011203107



Mounted on multi-bladed skyboards, Hellions sweep down from the sky while screaming chilling battle cries. These Dark Eldar delight in surprise attacks and use their speed and specialized weapons to strike quick and then move out of range before the enemy can turn their guns to bear.

HEAVY SUPPORT



RAVAGER DARK LANCE
9947011202804



Ravager Box (1)
99140112028



RAVAGER DISINTEGRATOR
9947011202805



The Ravager comes with the Raider Platform Sprue (99390112002), the Raider Crew Sprue (99390112003), and the Raider Hull Sprue (99390112004) shown in the Troops section.



RAVAGER LEFT SCYTHE
9947011202809



RAVAGER RIGHT SCYTHE
9947011202810



RAVAGER GUNNER 1
9947011202801



RAVAGER GUNNER 2
9947011202802



RAVAGER LEFT SIDE
9947011202806



RAVAGER RIGHT SIDE
9947011202807



RAVAGER WEAPON MOUNT
9947011202808



RAVAGER GUNNER ARMS
9947011202803



HEAVY SUPPORT

Constructed by the insane Haemonculi, the Talos is a torture device that sweeps across the battlefield on anti-gravitic motors, latches on to its foes, and incarcerates them within its armored shell.

PAINTING DARK ELДАР BLADES

Dark Eldar models have a variety of different blades that paint up well with a few simple techniques that yield great metallic looks.



TRADITIONAL METAL

1. Start with a Boltgun Metal drybrush. 2. Follow with a Chainmail drybrush. 3. Wash with Black Ink. 4. Finish with a highlight of Mithril Silver.



CLEAN SHARP METAL

1. Paint the blade with a 50/50 mix of Boltgun Metal and Chaos Black. 2. Highlight with Boltgun Metal. 3. Follow with a Chainmail highlight. 4. Finish with a Mithril Silver highlight.



RUSTY, WEATHERED METAL

1. Start with a Mithril Silver basecoat. 2. Add a Chestnut Brown wash. 3. Wash with a Chestnut Brown and Black Ink wash mix. 4. Finish with a Mithril Silver highlight.



ALIEN ALLOYS

1. Start with a Chainmail basecoat. 2. Add a Green Ink wash. 3. Follow with a Chestnut Brown wash. 4. Finish by drybrushing with Chainmail.



TALOS ARM MOUNT
9947011201208



TALOS CARAPACE
9947011201204



Talos Box (1)
99110112012



TALOS FUSELAGE
9947011201201



TALOS SCYTHE
9947011201209



TALOS GUN 1
9947011201210



TALOS GUN 2
9947011201211



TALOS PROW
9947011201203



TALOS SPIKES
9947011201205



TALOS BODY
9947011201202



TALOS NEEDLE ARM
9947011201206



TALOS PINCER ARM
9947011201207

All dimensions are supplied approximate. Models, kits, and sprays are all shown actual size unless otherwise stated. Contents may vary slightly from those shown.

HEAVY SUPPORT



Scourge Squad Box (5)
99110112011

Scourge w/ Heavy Weapon Blister (Random 1)
99060112035



SCOURGE SYBARITE
9947011201101

Each Scourge model in the boxed set or blister comes with the Scourge Wings shown below.



SCOURGE WINGS
9947011201108



Scourge w/ Splinter Rifle Blister (1)
99060112020



SCOURGE W/ SPLINTER RIFLE
9947011202001



SCOURGE BODY 1
9947011201102



SCOURGE BODY 2
9947011201103



SCOURGE BODY 3
9947011201104



SCOURGE BODY 4
9947011201105



SCOURGE DARK LANCE
9947011201106



SCOURGE SPLINTER CANNON
9947011201107



COLORS OF WAR

KEY

- Top Box(es): Basecoat Colors & Ink Washes
- Bottom Box(es): Highlights
- Mixed Colors

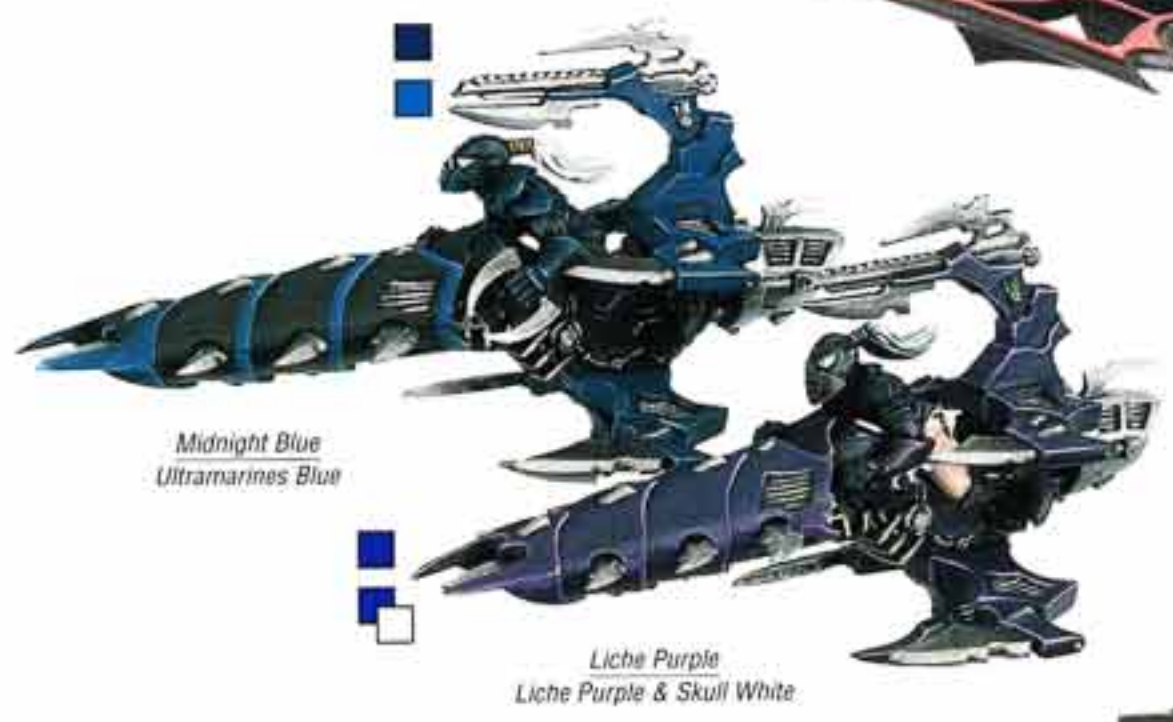

Above: Neil Green & Chris Smart used color banding on the front of the segments of the armor plating at the front of each Jetbike.



Below: Joe Hill used glyphs and runes on his Wych Raider to decorate the prow. (Shown 80% of actual size.)



Scorpion Green, Elf Flesh & Bleached Bone



Blood Red, Mithril Silver



Shadow Grey, Elf Flesh & Skull White



Blood Red, Liche Purple & Skull White



Blood Red, Burnished Gold



Fortress Grey, Mithril Silver



Shadow Grey, Blood Red



Enchanted Blue, Mithril Silver

All miniatures are supplied unpainted. Models, lists, and options are all shown actual size unless otherwise noted. Colors may vary slightly from those shown.

TACTICS

TIPS FOR WINNING WITH DARK ELДАР



- A. The webway portal is a very useful tool for Dark Eldar armies. Dark Eldar can bring in reserves through the portal rather than from the table edge and spring into action much more easily. If one webway portal is good, two are even better! Consider purchasing two webway portals to ensure that you can bring out heavy-hitting units like Talos and Ravagers into a position where they will do the most good when you need them to.
- B. Raiders are another way that Dark Eldar can maneuver into position on the battlefield. A great way to use these swift-but-fragile transports is to concentrate your force on one portion of the enemy lines by zooming up one side of the table. This strategy can be particularly effective in missions that use the *Escalation* rule. You can bring your Raiders onto the board in the same area and focus most of your army in a place where your opponent can bring only a portion of his army to bear.
- C. An Archon or Dracon can become quite a terror in assault with the right wargear. One interesting combination includes a tormentor helm, combat drugs, the shadow field, an agonizer, poison blades, and a Hellion skyboard. This combination of equipment gives you a commander who can zip around the battlefield and engage any enemy with a good chance of success. Against high-Toughness creatures, the poison blades will perform well, while the agonizer can handle most vehicles or opponents with a good armor save. In the meantime, the Hellion skyboard doesn't stop the commander from gaining the bonus for two hand weapons, and the tormentor helm gives the commander something to shoot with in the Shooting Phase as well!



COUNTERTACTICS

TIPS FOR FIGHTING AGAINST DARK ELДАР

- A. Webway portals, while dangerous, are susceptible to a couple of countermeasures. First, there's a chance you can destroy the model carrying the webway portal if you can identify him. Of course, you'll need quite a bit of firepower (and probably some indirect-fire weapons like a Basilisk or Whirlwind as well) to make certain. Second, webway portals are not very useful if you can surround them with your models to stop enemy units from coming onto the board. In this case, what you will need is lots of troops who can reach the webway portal in time (bikes, cavalry, jump infantry, and transports can help).
- B. Deployment is critical when facing an army that is as mobile as the Dark Eldar. By placing your army close together in one area of the board, you can respond with the majority of your force to almost any Dark Eldar maneuver.
- C. This commander is a daunting prospect for any squad to face and extremely difficult to kill due to the shadow field. However, this model can be taken down through several methods. Any weapons that ignore invulnerable saves (such as psycannons, incinerators, or warscythes) should destroy this commander fairly quickly. Another method is to surround the Dark Eldar commander and use the sheer weight of numbers to drag her down – although the shadow field fails only on a 1, if you make your opponent roll enough dice, that result will eventually come up!



SHOWCASE

Right: This menacing Talos conversion won Bruno Rizzo the silver in the vehicle category at the 2000 French Golden Demon competition.

Right: A Dark Eldar Lord by Jay Hall.

Below: A fantastic Dark Eldar Incubi Master by Felipe R. Dominguez is from the Spanish Golden Demon competition.



Above: Jason Dyer won the Best Army Appearance award with his Dark Eldar at the Seattle 2000 Grand Tournament.

Above: Keith Robertson's Drazhar, Master of Blades.



Above: Douglas Hann won the Slayer Sword at the 2002 Canada Golden Demon painting competition with "Brother's Keeper," an amazing Dark Eldar Lord conversion.



ALTERNATE MODEL – ELITES Grotesques

COMPONENTS FOR 4 COMPLETE MODELS

- 99380104001 Eldar Guardian Sprue
- 99380207002 Zombie Sprue

COMPLEXITY RATING



SHOWCASE



Left: This converted Incubi squad earned Tobias Merrian the Gold in the 40K Squad category at the 2000 UK Golden Demon competition.



Left: Paul Chamberlain's Dark Eldar Reavers were used in his 2002 Grand Tournament army.

Left: Dark Eldar Archon by Thomas Barse from the 2000 French Golden Demon competition.

ALTERNATE MODEL – ELITES

Wyches

COMPONENTS FOR 4 COMPLETE MODELS

- 9947011201804 Wych Impaler Arm
- 9947011203019 A. Vect Right Arm (x3)
- 9947021203602 Witch Elf 2
- 9947021203603 Witch Elf 3
- 9947021203604 Witch Elf 4
- 9947021204002 Witch Elf Standard Bearer

COMPLEXITY RATING



All miniatures are supplied unpainted. Models, bits, and sprues are all shown actual size unless otherwise noted. Contrasts may vary slightly from those shown.



ELDAR

Farseer Tyli shifted her mind and broadcast a message to the awaiting commanders. The time to launch the attack was now.

Instantaneously, each Eldar leader set his squads in motion. Their anti-gravitic engines whining under the sudden burst of speed, Jetbike squadrons and Falcons swept forward on the flanks. Guardians with their heavy weapons platforms emerged from cover to anchor the center. Rangers, far closer to enemy lines but hidden by their Cameleoline Cloaks, opened fire at key targets with their long rifles.

As Tyli had planned, the sudden synchronized attack had eradicated the Imperial forward firebase before a distress signal could be sent.



The Eldar race is ancient beyond human reckoning. It is said that the Eldar had mastered the intricacies of space travel before Mankind first looked upward at the stars.

The Eldar are a technically advanced but dying race and have suffered a vast cataclysm that split their once mighty civilization. Now, the Eldar are a race of wanderers fighting to reclaim their shattered domain in a galaxy of barbaric usurpers and insidious evil.

Above: Shawn Ledford won second place at Atlanta Games Day 2004 with his Seer Council.



Right: Bryan Shaw won third place in the Warhammer 40,000 Single Miniature category at the Los Angeles 2003 Golden Demon competition.

Fighting Style

More than any other army, the Eldar are made up of highly specialized squads, HQ types, and vehicles. When a masterful commander can play to the strengths of each squad or model, the Eldar become a nigh unstoppable force. In the hands of a novice, the army is fragile and easily broken. Blending the right mix for each game is an art unto itself.

Collecting an Eldar Army

Most players begin their Eldar armies with a strong force of Guardians (either Storm squads or Defender squads) and a Farseer to fulfill the compulsory HQ and two Troops choices. Next, the varied abilities of the Aspect Warriors allow the commander to pick and choose which skills he values most – the deadly charge of the Howling Banshees, the short-ranged firepower of the Fire Dragons, or the displacing movement of the Warp Spiders. Each of the Elites choices offers superlative abilities in some (but never all) the arts of war.

Eldar vehicles provide more fast and heavily armed options. With Falcons and Wave Serpents, the Eldar excel at swift attacks and flexible defense. These vehicles enable the Eldar to move the right units where they are needed.

Farseers and Warlocks provide the Eldar with very powerful psykers, and the towering might of a Wraithlord or the lightning-fast attacks of a Jetbike squadron will be hard to pass up.

Whether your style is moving quickly into hand-to-hand, hit-and-run attacks, or anything else you can come up with, an Eldar army that is focused toward an overall plan is a deadly force on the battlefield!



This Eldar Vyper by Bruno Grelier won first place in the Warhammer 40,000 vehicle category at the 1999 French Golden Demon.

All miniatures are supplied unpainted. Models, lists, and prices are all shown actual size unless otherwise noted. Contents may vary slightly from those shown.

Eldar Battle Force – 99120104005

- 20 Eldar Guardians
- 3 Eldar Jetbikes
- 1 Vyper Jetbike
- 1 Falcon Grav Tank
- 4 Warhammer 40,000 Jungle Trees



GETTING STARTED



**Codex:
Eldar**
60030104001



**Codex:
Craftworld Eldar**
60030104002



**Avatar of the Bloody-
Handed God Blister (1)**
99060104074



**AVATAR RIGHT
ARM & SWORD**
9947010400103



AVATAR MANE
9947010400105



AVATAR BLOODY HAND
9947010400104



AVATAR TORSO
9947010400102



AVATAR LEGS
9947010400101

HQ



Farseer Blister (1)
99060104068

*Farseers are potent psykers.
Their prodigious powers allow
them to see the future.*



FARSEER BODY
9947010406801



FARSEER SPEAR
9947010406802



**Eldrad Ulthran, Farseer
of Ulthwé Blister (1)**
99060104027
BIT NAME: ELDRAD ULTHRAN
BIT CODE: 9947010402701



HQ



Phoenix Lords on this page are only available via Special Offer.



Phoenix Lord Fuegan Blister (1)
99060104029



FUEGAN FIRE AXE
9947010402902



FUEGAN BODY
9947010402901



Phoenix Lord Karandras Blister (1)
99060104028



KARANDRAS HEAD
9947010402802



KARANDRAS BODY
9947010402801



Phoenix Lord Baharroth Blister (1)
99060104007



BAHARROTH BODY
9947010400701



BAHARROTH WINGS
9947010401906



Phoenix Lord Asurmen Blister (1)
99060104004

Phoenix Lords have traveled the galaxy for millennia and are utterly fearless. A Phoenix Lord will never fall back or be pinned – even by attacks that do not normally allow a Morale check to be taken.



Phoenix Lord Jain Zar Blister (1)
99060104006



JAIN ZAR BODY
9947010400601



JAIN ZAR LEFT ARM AND BLADE OF DESTRUCTION
9947010400602



JAIN ZAR RIGHT ARM & SILENT DEATH
9947010400603



ASURMEN BANNER POLE
9947010400402



ASURMEN BODY
9947010400401

Ulthwé Seer Council Box (5)
99110104084

SEER COUNCIL WITCH BLADE 3
9947010408404

SEER COUNCIL FARSEER 2
9947010408402

WARLOCK 3 W/ WITCH BLADE
9947010402406

SEER COUNCIL WARLOCK

SEER COUNCIL FARSEER 1
9947010408401

SEER COUNCIL WARLOCK BODY
9947010408403

Warlock with Singing Spear (9947010402407) and Warlock 3 with Witch Blade (9947010402406) can also be purchased in the Warlock Blister.

WARLOCK 1 W/ SINGING SPEAR
9947010402404

WARLOCK 2 W/ WITCH BLADE
9947010402401

WARLOCK 4 W/ WITCH BLADE
9947010406401

Warlock Blister (Random 1)
99060104024

Phoenix Lord Maugan Ra Blister (1)
99060104005

MAUGAN RA BACKPACK
9947010400503

MAUGAN RA BODY
9947010400501

MAUGAN RA MAUGETAR
9947010400502

Phoenix Lord Maugan Ra is only available via Special Offer.

PAINTING RUNES



Complete the highlighting and shading of the area where the rune will be positioned and let it dry. Next, take a sharpened pencil (the mechanical ones work the best) and lightly draw out the design that you wish to paint. If you are working over a dark color, use a white charcoal pencil.



Paint over the pencil lines with thinned-down Chaos Black paint. Test the consistency of the paint before applying it to the model. If the paint is too thin, it will no longer be opaque. If it's too thick, it will make your design lumpy and obscure the detail. When painting the design, make sure to cover the pencil lines completely with the paint.



Once dry, go back with a bright opaque color and paint in the center of the Chaos Black lines. When this coat dries, highlight the central line with a bit of pure Skull White. Save these tiny highlights for sharp corners or the tips of lines to make the design appear to have a bit more depth to it.

PAINTING GEMS



Begin by painting the gem with the desired base color. We used Jade Green for the base color.



Next, take the darker shade (Scaly Green here) and paint the upper right or left corner of the gem. While the paint is still wet, take another brush, wet it, and break up the lower border of the darker shade color until it makes a smooth transition into the base color. A little practice may be necessary, but the end result is quite attractive.



For the highlight, paint the bottom edge of the gem opposite the shading using the lighter shade color (Skull White added to Scaly Green in this case). Use the same technique as described above, making sure that you leave enough of the base color to make a smooth transition from highlight to shadow.



When satisfied with the blend of shadow, base, and highlight colors, take a bit of thinned Skull White paint and apply a single tiny highlight in the center of the darkest part of the gem. Finally, add a thin, curved line of Skull White along the bottom edge to finish off the overall effect.



ELITES

APPLYING DECALS



The application of a decal can add some extra detail and character to your models. Start by choosing an appropriate decal for your vehicle or model and carefully cut it

out from the sheet. It's a good idea to cut some extra space around one side of the decal. This space makes it easier to hold the paper while you transfer the decal to the model's surface.



Take a pair of tweezers and hold the transfer by the paper surrounding it. The shiny area is the part that will be transferred, so holding on to the paper anywhere

outside of this area should be fine. Dip the transfer in a shallow dish of water (we used a jar lid) and hold it under water for about 30 seconds. When the decal starts to peel away from the paper, it is ready to be transferred.



Take a brush and dampen the area where you plan to apply the transfer. This method will help you reposition the transfer to get the placement just right. While holding the

edge of the paper with the tweezers, take a brush and gently slide the decal off the paper onto the model's surface.



Reposition the decal with a wet brush until it is in the desired position. Next, take a piece of paper towel or a dry brush and gently dab away any excess water from the surface. This step

should affix your decal into place. If you notice bubbles under the decal, re-wet the decal and smooth it out with a damp brush.



Take some of the background color and paint over the shiny area around the decal. This step will help hide the fact that a decal was used and prevent it from detracting from

the overall appearance of the model. If you like, the rest of the transfer can be painted over in a different color to suggest a hand-crafted appearance.



Howling Banshees Blister (Random 2)
99060104067



HOWLING BANSHEE BODY 1
9947010406701



HOWLING BANSHEE BODY 2
9947010406702



HOWLING BANSHEE BODY 3
9947010406703



HOWLING BANSHEE SWORD 1
9947010406704



HOWLING BANSHEE SWORD 2
9947010406705



HOWLING BANSHEE SWORD 3
9947010406706



Howling Banshee Exarch Blister (1)
99060104070



HOWLING BANSHEE EXARCH BODY
9947010407002



HOWLING BANSHEE EXARCH WEAPON
9947010407001

All miniatures are supplied unpainted. Models, bits, and sprues are all shown at actual size unless otherwise noted. Contents may vary slightly from those shown.

ELITES



FIRE DRAGON BODY 1
9947010408201

FIRE DRAGON BODY 2
9947010408202

FIRE DRAGON BODY 3
9947010408203

Fire Dragons Blister (Random 2)
99060104082



FIRE DRAGON EXARCH FUSION GUN
9947010408002



Fire Dragon Exarch Blister (Random 1)
99060104080



FIRE DRAGON EXARCH BODY 1
9947010408001



FIRE DRAGON EXARCH BODY FOR FIREPIKE
9947010408003



FIRE DRAGON EXARCH FIREPIKE
9947010408004



Striking Scorpions Blister (Random 2)
99060104076



Striking Scorpion Exarch Blister (1)
99060104078



STRIKING SCORPION EXARCH CLAW
9947010407802



STRIKING SCORPION CHAINSWORD ARM 1
9947010407604



STRIKING SCORPION CHAINSWORD ARM 2
9947010407605



STRIKING SCORPION BODY 1
9947010407601



STRIKING SCORPION BODY 2
9947010407602



STRIKING SCORPION BODY 3
9947010407603



STRIKING SCORPION EXARCH BODY
9947010407801



ELITES



**Warp Spider
Exarch Blister (1)**
99060104030



**WARP SPIDER
EXARCH CARAPACE**
9947010403002



WRAITHGUARD HEAD 1
9947010400801



WRAITHGUARD HEAD 2
9947010400803



WRAITHGUARD HEAD 3
9947010400805



WARP SPIDER 1
9947010402601

WARP SPIDER 2
9947010402602

WARP SPIDER 3
9947010402603

Warp Spiders Blister (Random 2)
99060104087



**WARP SPIDER
EXARCH BODY**
9947010403001



**WARP SPIDER EXARCH
DEATHSPINNER**
9947010403003



Wraithguard Blister (Random 1)
99060104008



WRAITHGUARD BODY 1
9947010400804



WRAITHGUARD BODY 2
9947010400802



WRAITHGUARD BODY 3
9947010400806

All miniatures are supplied unpainted. Models, lines, and spaces are all shown actual size unless otherwise stated. Contents may vary slightly from those shown.

TROOPS



Guardians Box (16)
99120104003

Ask no Eldar a question, for they will give you three answers, all of which are true and horrifying to know.

Inquisitor Czevak

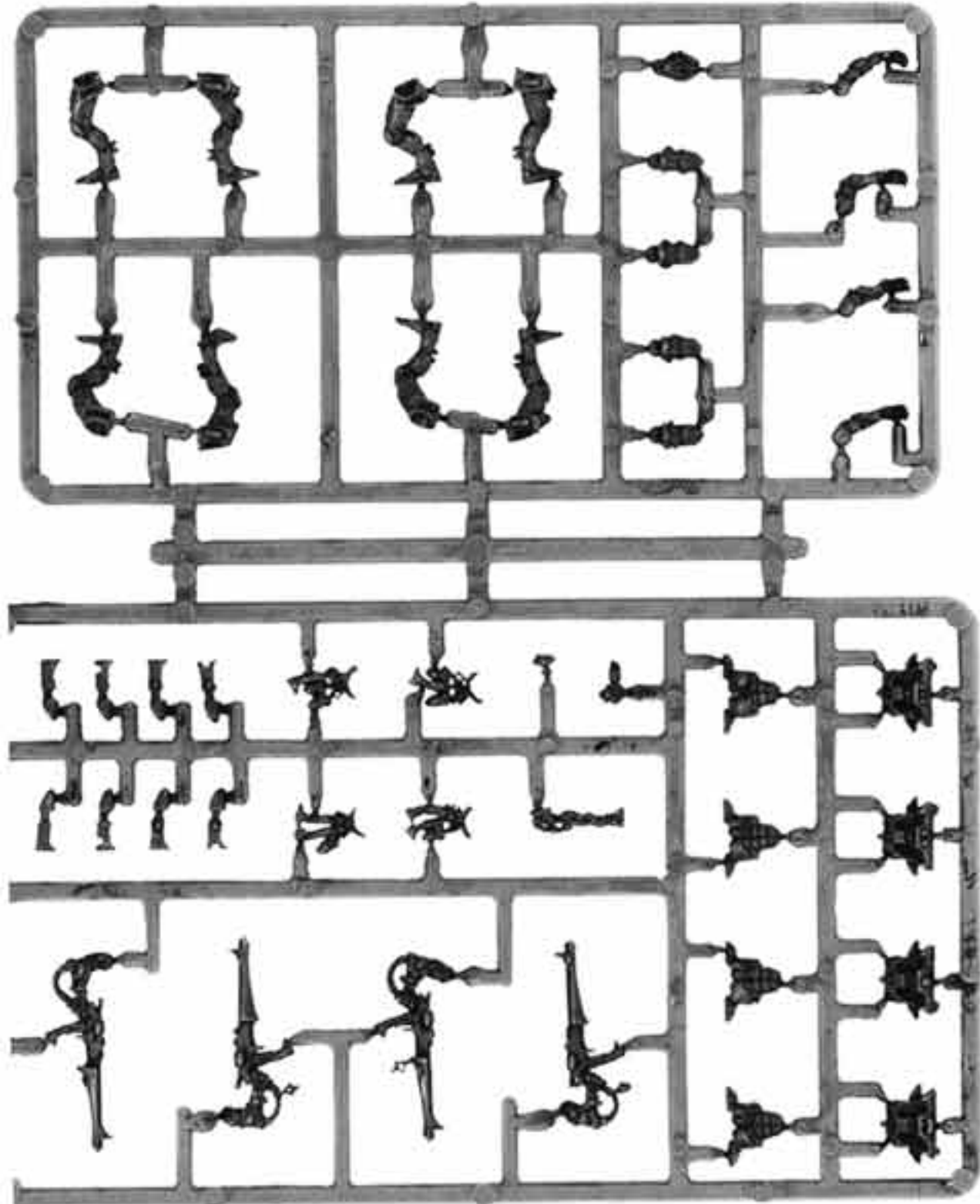

GUARDIANS SPRUE (SHOWN 90% ACTUAL SIZE)
99380104001

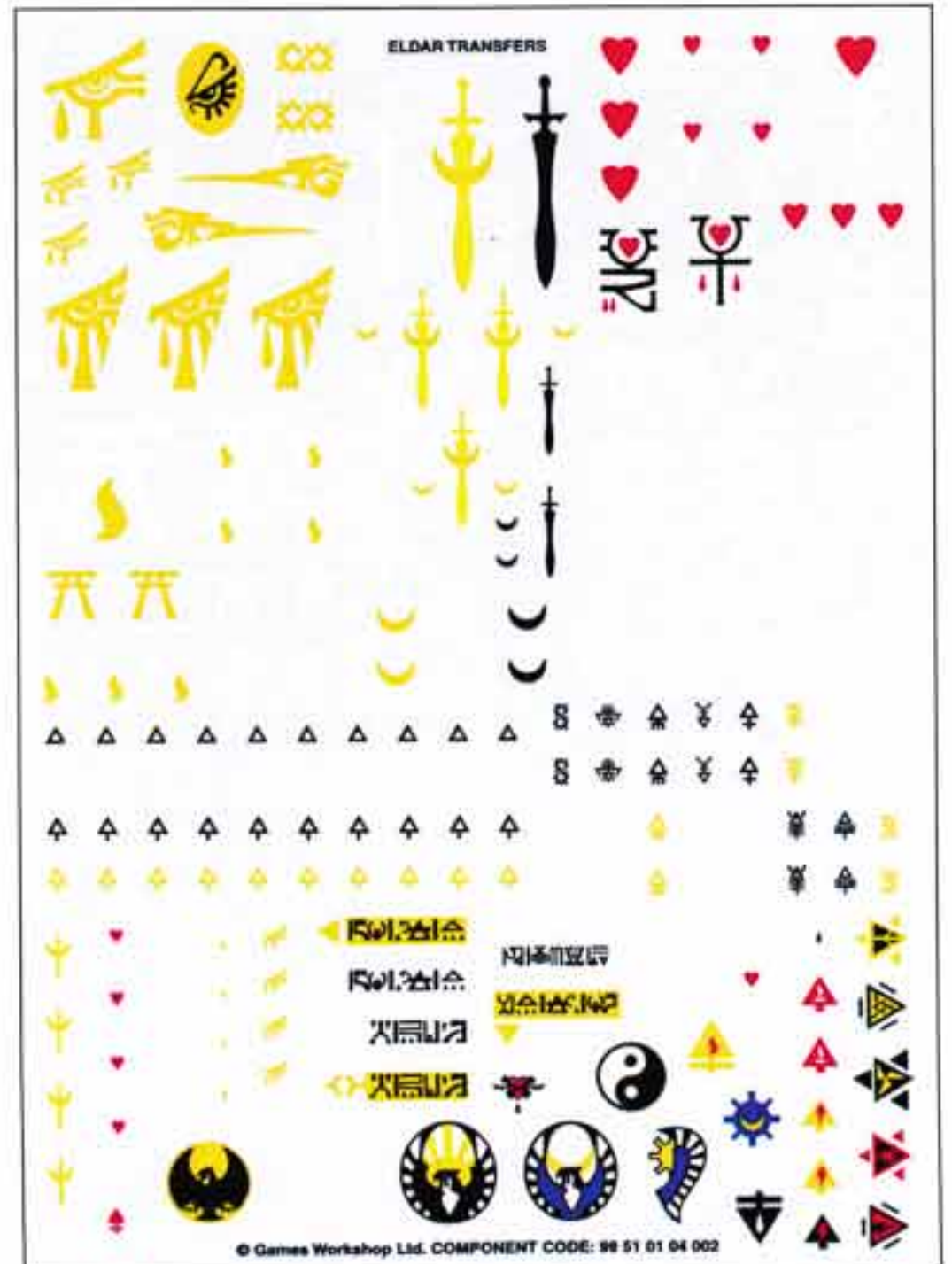

ELDAR DECAL SHEET (SHOWN 90% ACTUAL SIZE)
99510104002



TROOPS

The Eldar Storm Guardians boxed set comes with the Guardians Sprue (99380104001) and Eldar Decal Sheet (99510104002) shown on the previous page.



Eldar Storm Guardians Box (8)
99110104085



STORM GUARDIAN PISTOL SPRUE
9947010408502



STORM GUARDIAN CHAINWORD SPRUE
9947010408503



STORM GUARDIAN HEADS SPRUE
9947010408501



STORM GUARDIAN POWER WEAPON SPRUE
9947010408504



STORM GUARDIAN ASSAULT WEAPON SPRUE
9947010408505



Rangers Blister (Random 3)
99060104015



RANGER W/ LONG RIFLE 1
9947010401511



RANGER W/ LONG RIFLE 2
9947010401513



RANGER W/ LONG RIFLE 3
9947010401516



RANGER W/ LONG RIFLE 4
9947010401512



RANGER W/ LONG RIFLE 5
9947010401514



RANGER W/ LONG RIFLE 7
9947010401503



RANGER W/ POWER SWORD AND SHURIKEN PISTOL
9947010401502

TROOPS



**Dire Avengers
Box (8)**
99110104075



**DIRE AVENGER
TABARD SPRUE**
9947010407505



**DIRE AVENGER
HEAD 1**
9947010407501



**DIRE AVENGER
HEAD 2**
9947010407502



**DIRE AVENGER EXARCH
SHURIKEN PISTOL**
9947010407503



**DIRE AVENGER EXARCH
POWER SWORD**
9947010407504

The Dire Avengers boxed set comes with the Guardians Sprue (99380104001) and Eldar Decal Sheet (99510104002).



**Heavy Weapons Platform Blister
(Random Weapon Platform & 2 Random Crew)**
99060104086

The Heavy Weapons Platform Blister comes with one random weapon.



GUN CREW BACKPACK
9947010407714

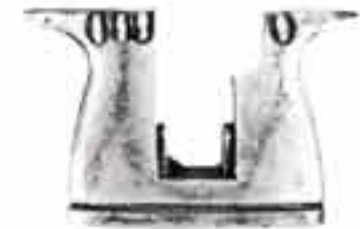

ELDAR WEAPON SHIELD
9947010407902



**ELDAR HEAVY
WEAPON PLATFORM**
9947010407901



**GUN LOADER
W/ AMMO BOX**
9947010407708



**GUN LOADER
W/ SHURIKEN CATAPULT**
9947010407709



**GUN LOADER
W/ BELT SCANNER**
9947010407710

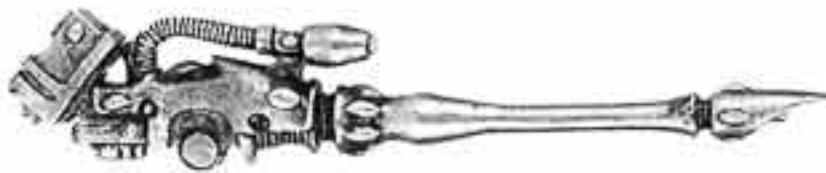

BRIGHT LANCE
9947010402502



STAR CANNON
9947010407905



SCATTER LASER
9947010407903



**GUNNER W/
SHURIKEN PISTOL**
9947010407711



GUNNER
9947010407712



GUNNER W/ HELMET
9947010407713



MISSILE LAUNCHER
9947010402503



SHURIKEN CANNON
9947010407904

TROOPS



Wave Serpent Box (1)
99120104007

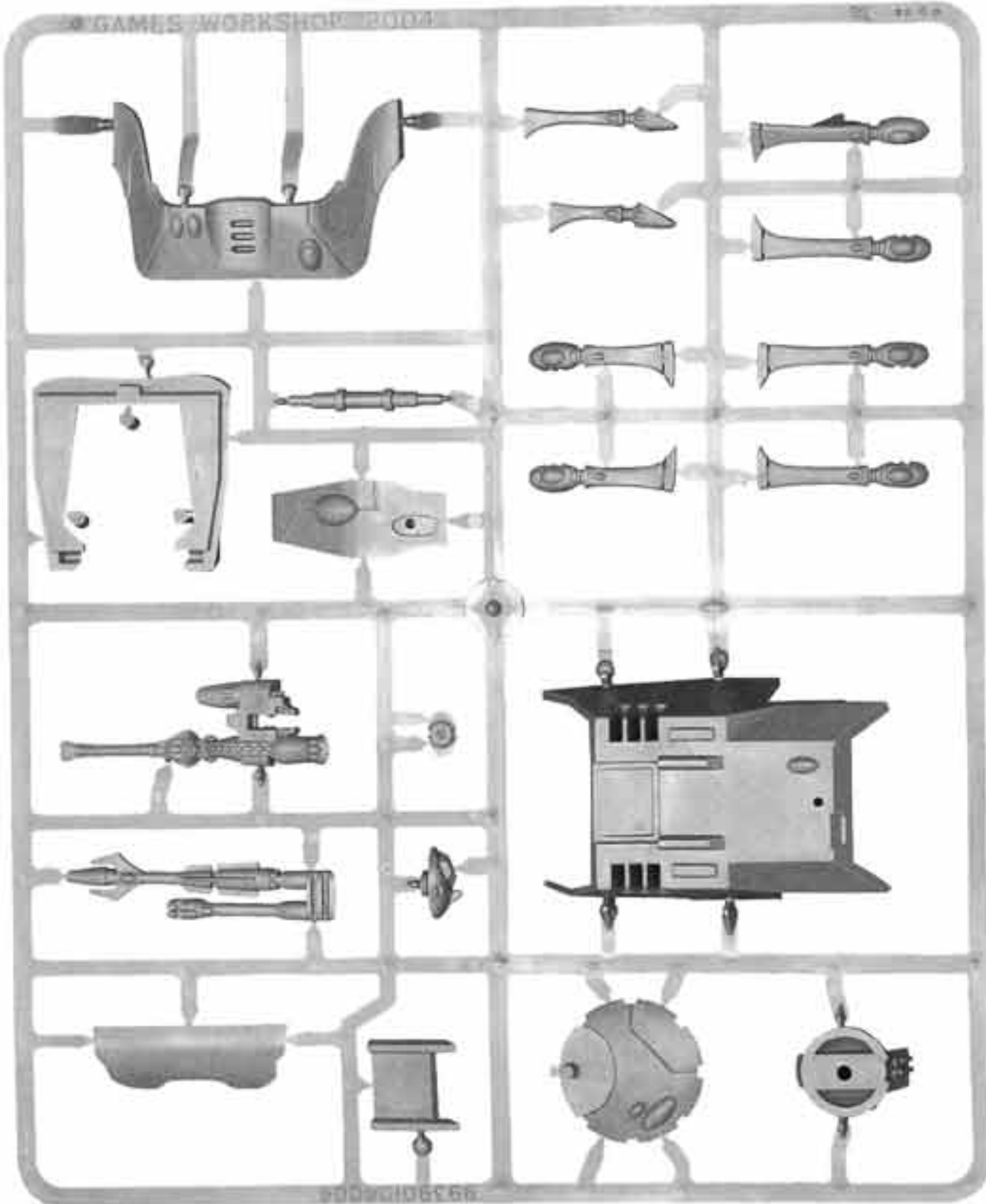

WAVE SERPENT SPRUE
99390104004

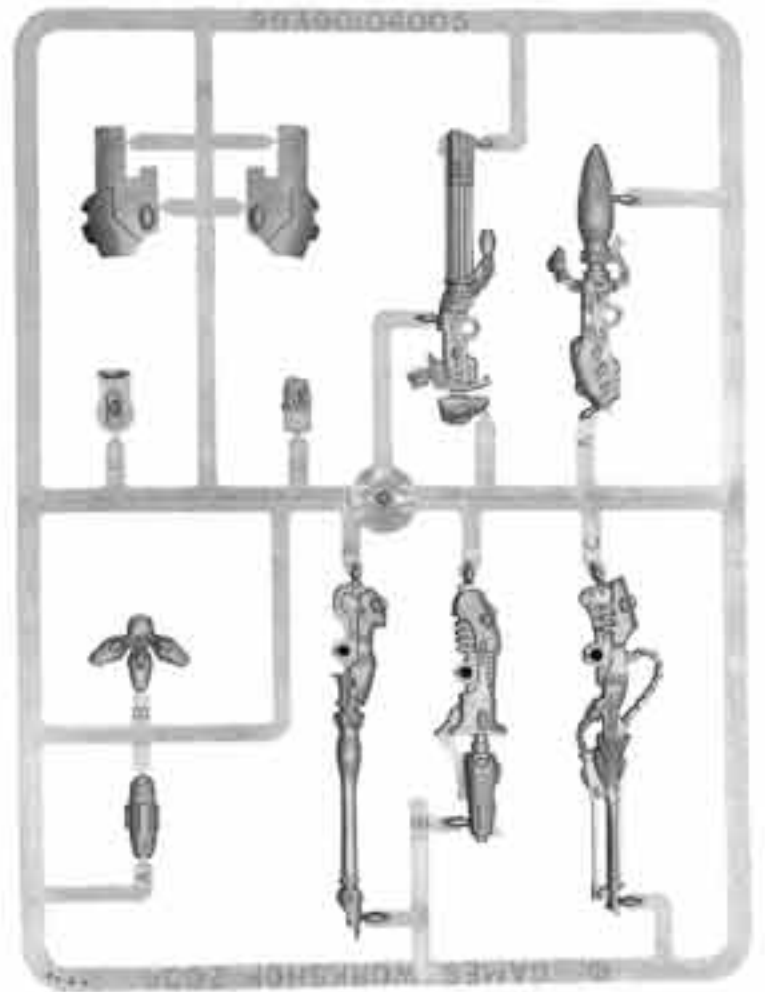

HEAVY WEAPONS SPRUE
99390104005

The Wave Serpent Box includes the Eldar Decal Sheet (99510104002) shown in the Troops section, the Grav Tank Hull Top & Bottom Sprues (99390104001 & 3), and the Vyper Jetbike Canopy (99399999038) all shown with the Falcon Grav Tank.

FAST ATTACK



Shining Spear Mk 2 Box (3)
99140104089

The Shining Spears Squad comes with the Jetbike Sprue (99399999036) shown on the next page.



SHINING SPEAR EXARCH BODY
9947010407101



SHINING SPEAR BODY 1
9947010406901



SHINING SPEAR BODY 2
9947010406902



SHINING SPEAR BODY 3
9947010406903



SHINING SPEAR EXARCH LEGS
9947010407103



SHINING SPEAR LEGS 1
9947010406908



SHINING SPEAR LEGS 2
9947010406909



SHINING SPEAR GUIDANCE SYSTEM
9947010406906



SHINING SPEAR EXARCH WEAPON SPRUE
9947010407102



SHINING SPEAR BANNER POLE
9947010406907



SHINING SPEAR LANCE 1
9947010406904



SHINING SPEAR LANCE 2
9947010406905

The contents of the boxed set can create three Shining Spears or two plus an Exarch.



JETBIKE BANNERS

Feel free to photocopy these banners to use on your Jetbikes! Simply fold them in half along the Jetbike's pole, and the banner will be level with the ground. Banners can help your Jetbikes look more distinctive. If you wish, you can even come up with your own custom design to paint on the banner for an even more personalized look. Just be careful when putting Jetbikes with banners away into your carrying case – you don't want to tear or bend the banners.

ULTHWÉ

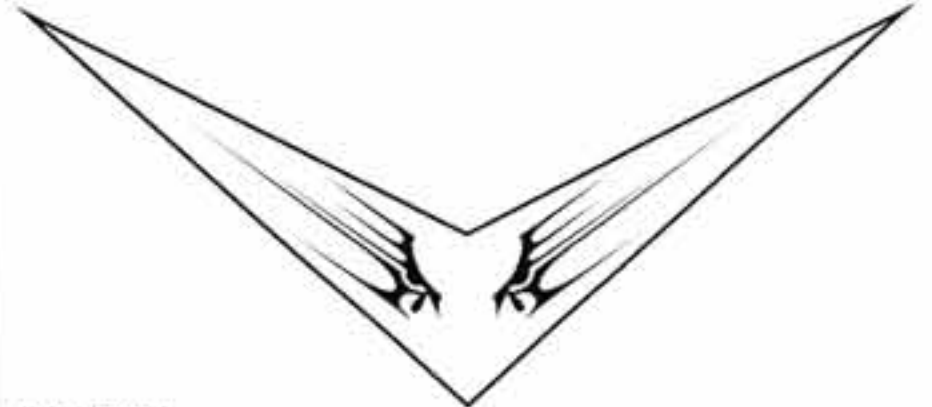

IYANDEN

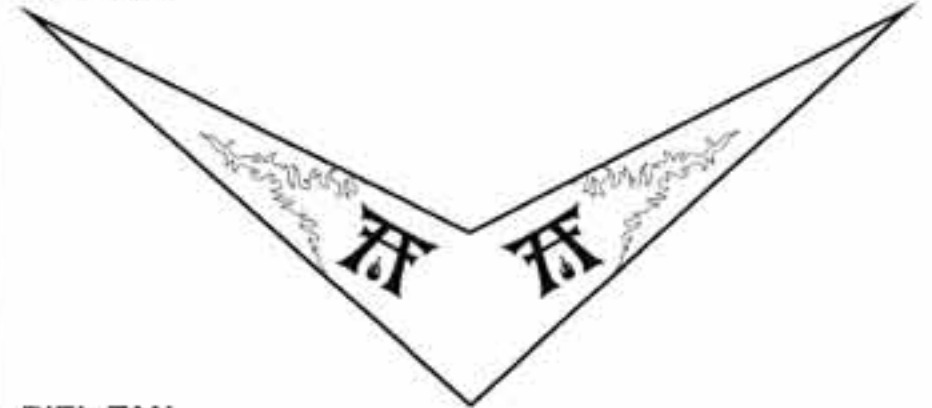

BIEL-TAN



ALAITOC

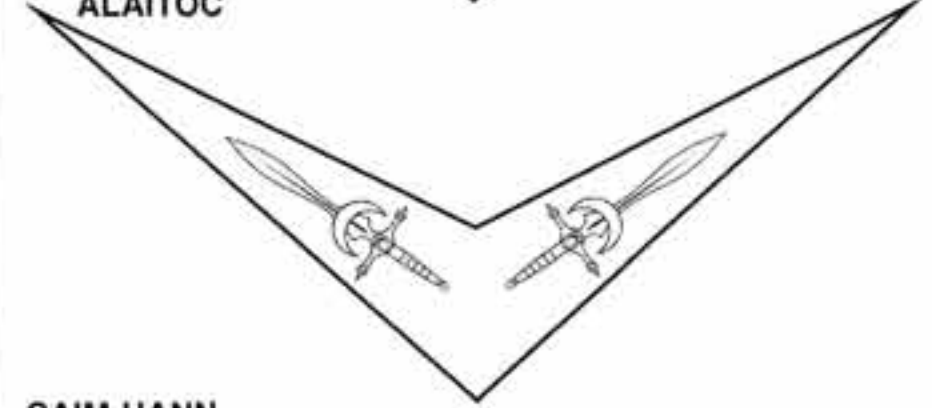

SAIM-HANN

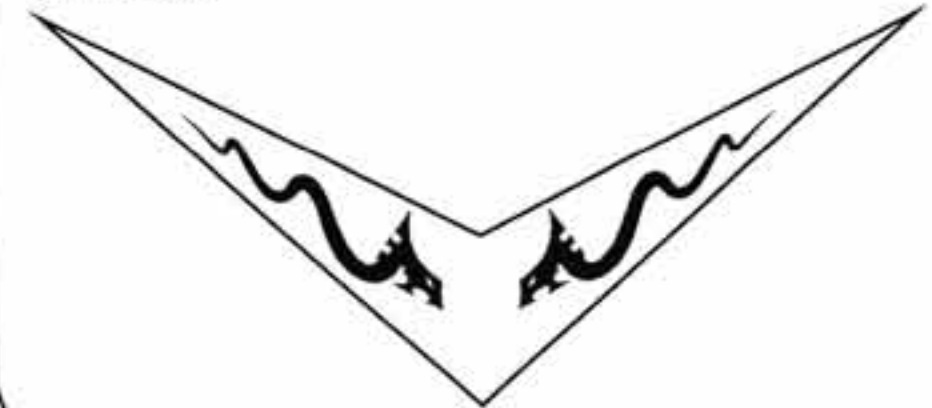

FAST ATTACK



Jetbike Box (1)
99120104002



Jetbike w/ Shuriken Cannon Box (1)
99140104031



Vyper Jetbike Box (1)
99120104006

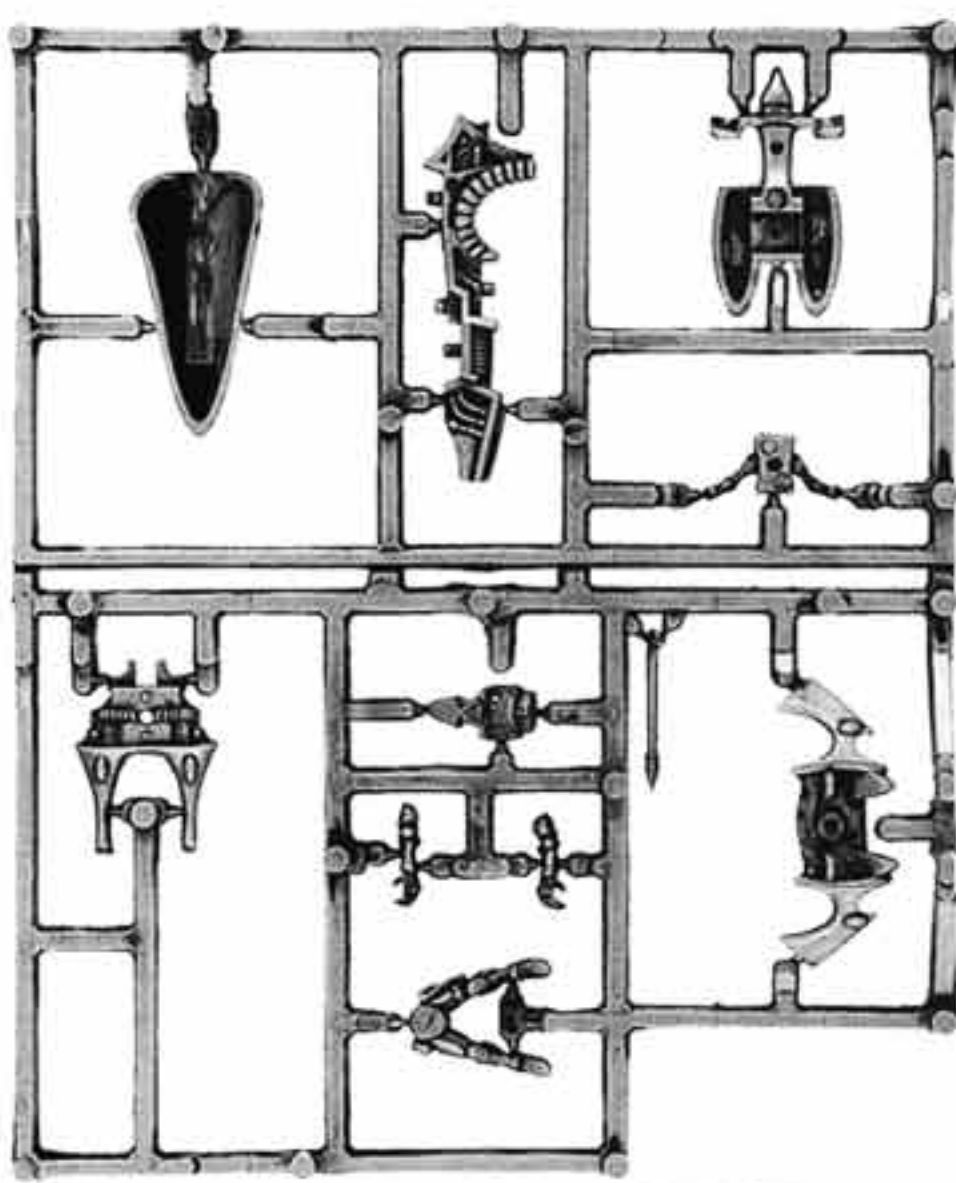

JETBIKE SPRUE (SHOWN 60% ACTUAL SIZE)
99399999036



JETBIKE SHURIKEN RIDER TORSO
9947010403101

The Jetbike w/ Shuriken Cannon includes the Jetbike Sprue (99399999036).

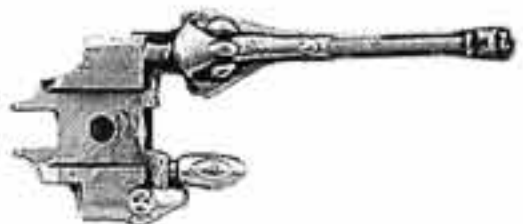

JETBIKE SHURIKEN CANNON
9947010403102



VYPER JETBIKE CANOPY
99399999038

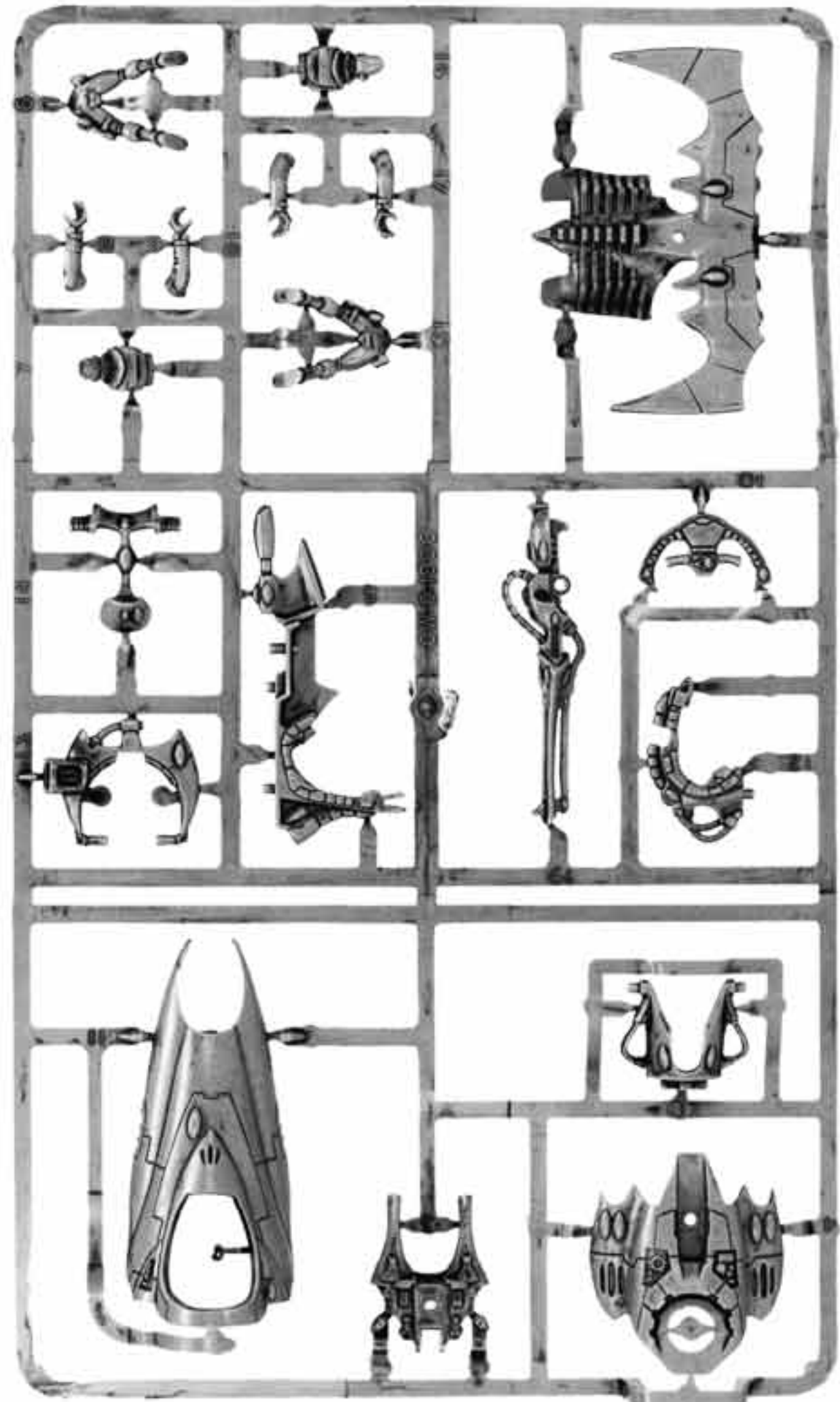

VYPER JETBIKE SPRUE (SHOWN 70% ACTUAL SIZE)
99399999037

FAST ATTACK



Swooping Hawk Exarch Blister (1)
99060104081



SWOOPING HAWK EXARCH WING
9947010408102



Swooping Hawks Blister (Random 2)
99060104083



SWOOPING HAWK EXARCH HEAD & ARM SPRUE
9947010408103



SWOOPING HAWK EXARCH BODY
9947010408101



SWOOPING HAWK WINGS
9947010408304



SWOOPING HAWK BODY 1
9947010408301



SWOOPING HAWK BODY 2
9947010408302



SWOOPING HAWK BODY 3
9947010408303

HEAVY SUPPORT



Dark Reapers Blister (Random 2)
99060104072



DARK REAPER MISSILE LAUNCHER
9947010407204



DARK REAPER BODY 1
9947010407201



DARK REAPER BODY 2
9947010407202



DARK REAPER BODY 3
9947010407203



Dark Reaper Exarch Blister (1)
99060104073

BIT NAME: DARK REAPER EXARCH
BIT CODE: 9947010407301



HEAVY SUPPORT

PAINTING ELДАР VINE PATTERNS

Vines can add some interest to the flat surface of the wings on Eldar tanks such as the Falcon Grav Tank and Fire Prism Grav Tank.

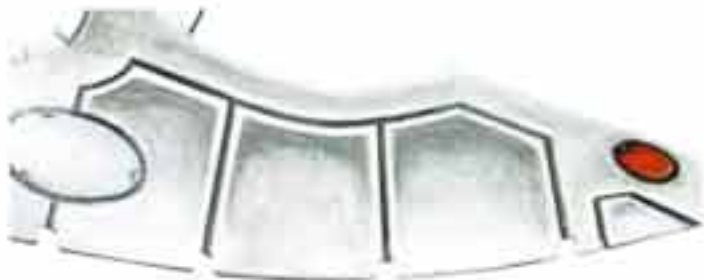

Begin by shading and highlighting the background color over which the vine pattern will be painted. Be sure to choose a background color that will contrast with the color of your vines so that they will really stand out.



Next, draw a series curved lines with a pencil over the surface. Try to keep the pattern looking random and always keep the lines curved with no straight sections. Aim to keep the lines a uniform distance from one another. When you're satisfied with the pattern, water down some paint (Dark Angels Green in this case) and paint over the lines. Varying the width of the lines will add to the overall grace of the curves, but that's a matter of taste.



When the basic lines are dry, go back in with the pencil and add jagged thorns on either side of the vines. As with the vine curves, try to keep the thorns a uniform distance from one another. Paint the thorns with the same base color used on the vines themselves.



Go back in and highlight the centers of the lines with a lighter shade of the vine color. When this is dry, add another brighter highlight around the most pronounced curves to add further depth to the vines. At this point, touch up any blemishes with the background color. Finally, sit back and marvel at how easy and attractive the overall effect is!



Falcon Grav Tank Box (1)
99120104001



The Falcon Grav Tank boxed set includes the Eldar Decal Sheet (99510104002) shown in the Troops section.

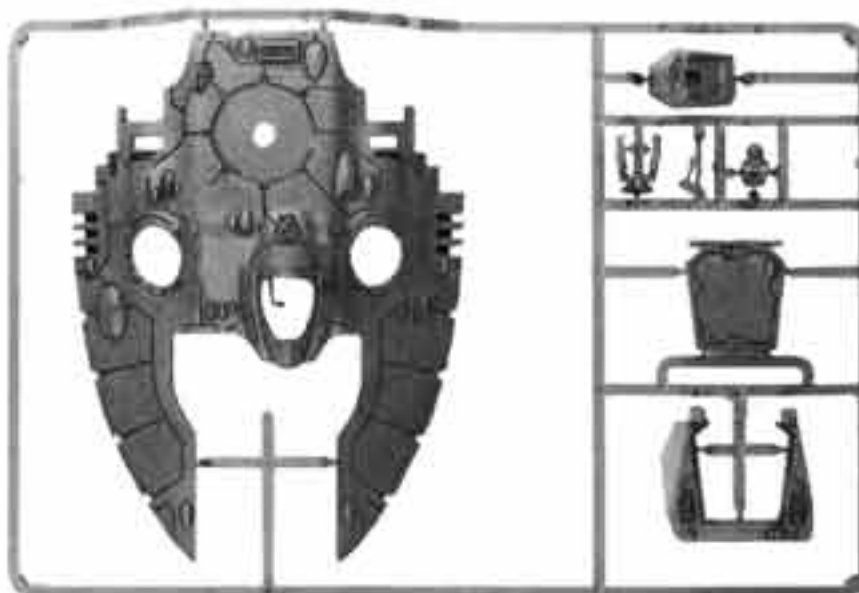

GRAV TANK HULL TOP SPRUE (SHOWN 30% ACTUAL SIZE)
99390104001



VYPER JETBIKE CANOPY
99399999038

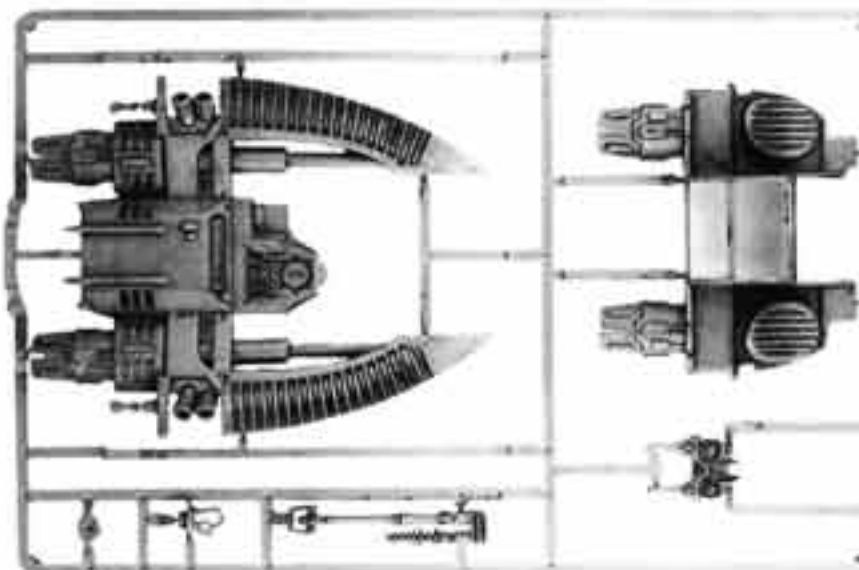

GRAV TANK HULL BOTTOM SPRUE (SHOWN 30% ACTUAL SIZE)
99390104003

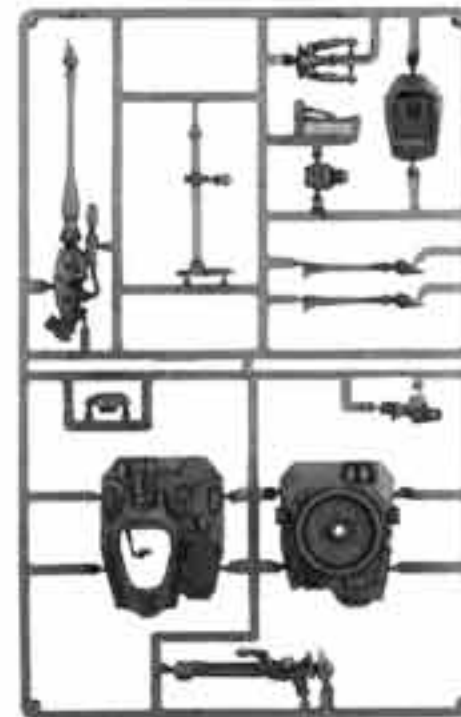

GRAV TANK TURRET SPRUE (SHOWN 30% ACTUAL SIZE)
99390104002

The Fire Prism Grav Tank boxed set comes with the three plastic Grav Tank Sprues (99390104001, 99390104002, and 99390104003) pictured on the previous page and the Eldar Decal Sheet (99510104002) shown in the Troops section.

HEAVY SUPPORT



Fire Prism Grav Tank Box (1)
99140104001



FIRE PRISM CRYSTAL SIDE A & B
9947010403804 & 5



FIRE PRISM PROBE
9947010403802



FIRE PRISM LASER PROJECTOR
9947010403807



FIRE PRISM SENSOR
9947010403803



FIRE PRISM ENERGIZER
9947010403801



FIRE PRISM GENERATOR
9947010403806



Support Weapon Platform Box (1 Platform & 2 Crew)
99110104086

The crew for the Support Weapon Platform (Gunner - 9947010407712 and Gun Loader w/ Shuriken Catapult - 9947010407709) can be found in the Troops section with the Heavy Weapon Platform.

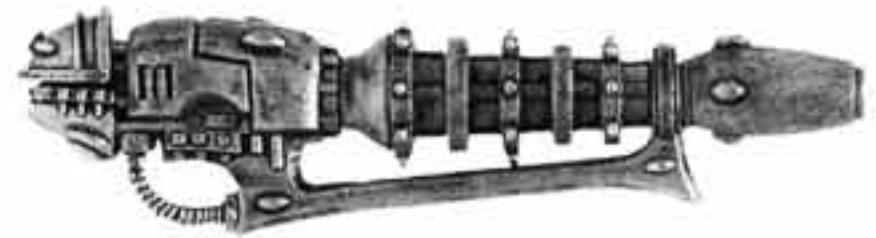

ELDAR VIBRO-CANNON
9947010407705



SUPPORT WEAPON PLATFORM
9947010407701



SUPPORT WEAPON TARGETER
9947010407703



SUPPORT WEAPON MOUNT
9947010407704



ELDAR WEB SPINNER
9947010407706



SUPPORT WEAPON PIVOT
9947010407702



ELDAR D-CANNON
9947010407707



HEAVY SUPPORT



War Walker Box (1)
99110104002

The War Walker includes the Bright Lance (9947010402502), Scatter Laser (9947010407930), and Star Cannon (9947010407905) – all of which can be found in the Troops section.



WAR WALKER LEFT LEG
9947010400214



WAR WALKER RIGHT LEG
9947010400213



WEAPON SHIELD
9947010400212



WAR WALKER & WRAITHLORD TORSO
9947010400201



WAR WALKER GUARDIAN
9947010400205

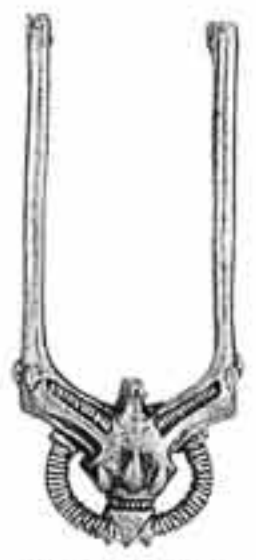

WAR WALKER POWER PLANT
9947010400202



Wraithlord Box (1)
99110104003



WRAITHLORD LEFT ARM
9947010400305

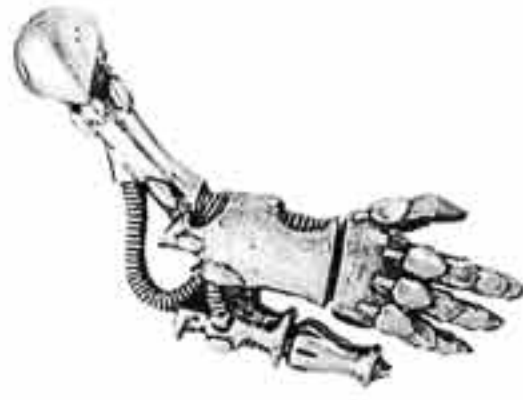

WRAITHLORD RIGHT ARM
9947010400304



The Wraithlord includes the Torso (9947010400201) shown above and the Bright Lance (9947010402502), Scatter Laser (9947010407930), and Star Cannon (9947010407905) – all of which can be found in the Troops section.



WRAITHLORD LEFT LEG
9947010400308



WRAITHLORD RIGHT LEG
9947010400307



WRAITHLORD POWER PLANT
9947010400302



WRAITHLORD HEAD
9947010400303

TACTICS

TIPS FOR WINNING WITH ELDAR



A. A Farseer and some Warlock bodyguards mounted on jetbikes constitute a formidable squad, both for headhunting (shuriken catapults and the Mind War power are very good for taking out enemy HQ units) and tank hunting (singing spears and witchblades, as mentioned above, do very well against vehicles). This unit is amazingly resilient (the jetbikes provide a 3+ armor save in addition to the Warlock's and Farseer's rune armor – not to mention the Fortune power) and also very fast with the new turbo-boost rule that enables the unit to get nearly anywhere it needs to on the battlefield.

B. A unit of Wraithguard led by a Warlock with the Enhance power can tie up enemy units in hand-to-hand turn after turn. This unit also excels at tank hunting. A squad of five Wraithguard and a Warlock in a Wave Serpent can provide you with a nearly unrivaled ability to take out enemy vehicles. Even extremely tough vehicles like the Land Raider or the Monolith are vulnerable to wraithcannon shots, singing spears, and witchblades!



COUNTERTACTICS

TIPS FOR FIGHTING AGAINST ELDAR

A. Although the Farseer and his bodyguard mounted on jetbikes can be very tough to kill, that unit still doesn't cause too many casualties in close combat. Any reasonably resilient unit can tie up the Farseer and his Warlocks for most of the game without needing to worry about being cut down. Another benefit of assaulting the Farseer's unit is that you may shut down some of his psychic powers (some require line of sight, and some are used in the Shooting Phase – neither type works well in the middle of a big melee). One chance to destroy this unit lies in assault – should you manage to win and chase the Eldar down, you'll wipe them out no matter what. Of course, with the Eldar's high Initiative, this result is possible but not likely.

B. Wraithguard are tough, but they are not impossible to beat. Heavy weapons fire (and especially ordnance blasts from battle cannons or earthshakers) will cut Wraithguard down without too much trouble. The key thing to remember about Wraithguard is that the unit is fairly slow. While Wraithguard can be transported in a Wave Serpent, it's rather likely that you'll end up facing them on foot as well. Without a transport, the Wraithguard can be outmaneuvered. If you decide when and where to fight these ghost warriors, they won't be much of a hindrance.



COLORS OF WAR

KEY

■ Top Box(es): Basecoat Colors & Ink Washes

■ Bottom Box(es): Highlights

■ Mixed Colors

Ulthwé. Ulthwé is one of the most sinister Craftworlds, and its black uniforms look suitably grim and foreboding. To emphasize this theme, we used a bone color to contrast the black. Bone is more subtle than pure white and helps keep the tone of the army uniformly dark.



Chaos Black, Red Gore
Shadow Grey, Blood Red



Chaos Black, Golden Yellow
Fortress Grey, Sunburst Yellow & White



Chaos Black, Bleached Bone
Fortress Grey, Skull White

Alaitoc. The primary color of the Alaitoc Craftworld is deep blue with a bright contrasting color such as Sunburst Yellow. To add a bit more of an alien feel, we have used a mottled effect to vary the colors on the blue parts of the armor.



BLUE ARMOR
Regal Blue, Ultramarines Blue
Enchanted Blue, Ice Blue

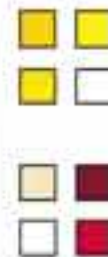

YELLOW ARMOR
Golden Yellow, Yellow Ink
Sunburst Yellow & Skull White



WEAPON
Bleached Bone, Scab Red
Skull White, Blood Red



Scorched Brown, Chaos Black
Desert Yellow & Kommando Khaki

Iyanden. We used a very striking, bright shade of yellow for our Iyanden force and dark blue as a richer color to complement the bold armor. You can vary this color scheme for your own army with different combinations of yellows and contrasting blues.



Golden Yellow, Midnight Blue
Sunburst Yellow, Ultramarines Blue



Golden Yellow, Midnight Blue
Sunburst Yellow, Ice Blue



Golden Yellow, Regal Blue
Sunburst Yellow, Enchanted & Ice Blue



Snakebite Leather, Dark Angels Green
Bleached Bone, Goblin & Scorpion Green



Regal Blue, Bleached Bone
Enchanted Blue, Skull White

Biel-Tan. The Craftworld of Biel-Tan is the most aggressive, and its primary colors are white and green. These colors represent death (white) or hope and renewal (green).



Catachan Green, Fortress Grey
Goblin Green, Skull White



Shadow Grey, Catachan Green
Skull White, Goblin Green



Codex Grey, Snot Green
Fortress Grey, Snot Green & Skull White

Saim-Hann. The best way to get a good looking Saim-Hann force is to find a way of painting a strong red that you are comfortable with. You could make a very bold red by using Blood Red or keep the tone darker and more sinister by choosing Scab Red.



Red Gore, Shadow Grey
Blood Red, Skull White



Scab Red, Chaos Black
Scab Red & Skull White, Fortress Grey

KEY
 ■ Top Box(es): Basecoat Colors & Ink Washes ■ Bottom Box(es): Highlights ■ Mixed Colors

COLORS OF WAR



*Bleached Bone, Snot Green
Skull White, Scorpion Green*



*Red Gore, Bubonic Brown
Blood Red, Bleached Bone*



*Chaos Black, Shadow Grey & Chaos Black
Bleached Bone, Shadow Grey & Skull White*



*Ultramarines Blue, Codex Grey
Ice Blue, Skull White*

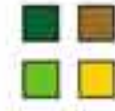

*Snot Green, Dwarf Bronze
Scorpion Green, Shining Gold*



*Hawk Turquoise, Dark Angels Green
Ice Blue, Goblin Green*



*Codex Grey, Golden Yellow
Space Wolves Grey, Sunburst Yellow*



*Codex Grey, Enchanted Blue
Fortress Grey, Skull White*

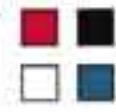

*Blood Red, Chaos Black
Skull White, Shadow Grey*



*Chaos Black, Red Gore
Dwarf Bronze, Shining Gold*

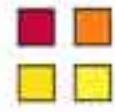

*Blood Red, Fiery Orange
Sunburst Yellow, Bad Moon Yellow*



*Scab Red, Brazen Brass
Blood Red, Burnished Gold*



*Chaos Black, Blood Red
Fortress Grey, Sunburst Yellow*



*Snot Green, Golden Yellow
Scorpion Green, Bad Moon Yellow*



*Golden Yellow, Catachan Green
Skull White, Catachan Green & Skull White*



*Dark Angels Green, Golden Yellow
Scorpion Green, Sunburst Yellow*



*Chaos Black, Liche Purple & Chaos Black
Shadow Grey, Liche Purple & Skull White*

All minifigures are supplied unpainted. Models, bases, and sprues are all shown actual size unless otherwise noted. Contrast may vary slightly from those shown.



SHOWCASE

Below: This Dark Reaper Squad by Doug Bissett won third place at the 2004 Atlanta Golden Demon Painting Competition.



Left: Louis Lamarre's Farseer won third place at the French 2004 Golden Demon Painting Competition.

ALTERNATE MODEL – HQ **Eldar Warlock**

COMPONENTS FOR 4 COMPLETE MODELS

- 9947010406902 Shining Spear Body 2 (x4)
- 9947021204608 Cold One Knight Shield 3 (x4)
- 99380104001 Eldar Guardian Sprue
- 9947010406802 Eldar Farseer Spear (x4)
- 9947010407505 Dire Avenger Tabard Sp. (x4)

COMPLEXITY RATING



ALTERNATE MODEL – FAST ATTACK **Saim-Hann Wild Rider**

COMPONENTS FOR 1 COMPLETE MODEL

- 99399999036 Eldar Jetbike Sprue
- 9947010406704 Howling Banshee Sword 1
- 9947010406902 Shining Spear Body 2

COMPLEXITY RATING:



ALTERNATE MODEL – TROOPS **Alaitoc Pathfinder**

COMPONENTS FOR 4 COMPLETE MODELS

- 99380104001 Eldar Guardian Sprue
- 99380212001 Dark Elf Warrior Sprue
- 9947010800104 Exitus Rifle 2 (x4)

COMPLEXITY RATING



All miniatures are supplied unpainted. Models, foto, and sprues are all shown actual size unless otherwise stated. Contents may vary slightly from those shown.

SHOWCASE



Right: Rich Van Meter's Wave Serpent won first place at the 2004 LA Golden Demon Painting Competition. Rich went the extra mile and ran tiny lights along the sides of his Wave Serpent.



Golden Demon Models – Clockwise, Starting from the Right: Eldar Warlock by Christian Blair (UK – 1999), Phoenix Lord Baharroth by Sebastian Fitch (Canada – 2001), Avatar by Bryan Shaw (U.S. – 2003), Eldrad Ulthran by Thierry Husser (France – 1997), Farseer on Jetbike by Marcus Blackman (Australia – 2000), and Wraithlord by Douglas Hahn (US – 2000).



All positions are supplied unprinted. Models, bits, and sprues are all shown actual size unless otherwise noted. Contents may vary slightly from those shown.

IMPERIAL GUARD

Listen and remember. You are Imperial Guardsmen now. It does not matter to me whether you come from Catachan or Valhalla. I don't care whether you are a volunteer or were rounded up by an enlistment gang. I will teach you to march like Imperial Guardsmen. I will teach you to maintain and fire your lasguns like Imperial Guardsmen. I will teach you to fight like Imperial Guardsmen, and that means learning every dirty trick in the segmentum. Most importantly, I will teach you your duty, and you will do it without hesitation, on command. The reason you will do this is because our immortal Lord, the Emperor of Mankind, owns your pitiful lives. If there is one worthwhile thing you will ever do, it is to honor your debt to Him.

The Imperial Guard are drawn from the innumerable inhabited worlds that make up the Imperium, and their ranks are truly immeasurable. While there is much conformity and regulation in the Imperial Guard, there is also an amazing amount of diversity as many regiments from different worlds maintain aspects of their home identity. These brave soldiers stand and fight for the Emperor across a thousand battle zones scattered throughout the vastness of Imperial space.

Fighting Style

The Imperial Guard are not genetically engineered, nor do they use super-powered alien technology. The basic soldier of the Imperial Guard does not have claws, mutations, or thick chitinous hides. What Imperial Guard members do have, however, is an amazing array of firepower. In addition to squad after squad of infantry armed with lasguns and heavy weapons, the mechanized branch can field deadly armor and artillery. Advancing against an Imperial Guard army means to march forward against

a veritable wall of incoming fire.

Dismissing Imperial Guard tactics as merely standing back and shooting can be misleading.

First off, there are numerous troops and options for



Above: Joe Hill won first place at the 2003 UK Games Day.



Right: Timothy Whittemore's Kasrkin Hunter/Killer Armored Scout Car was a runner-up at the 2004 Chicago Games Day.

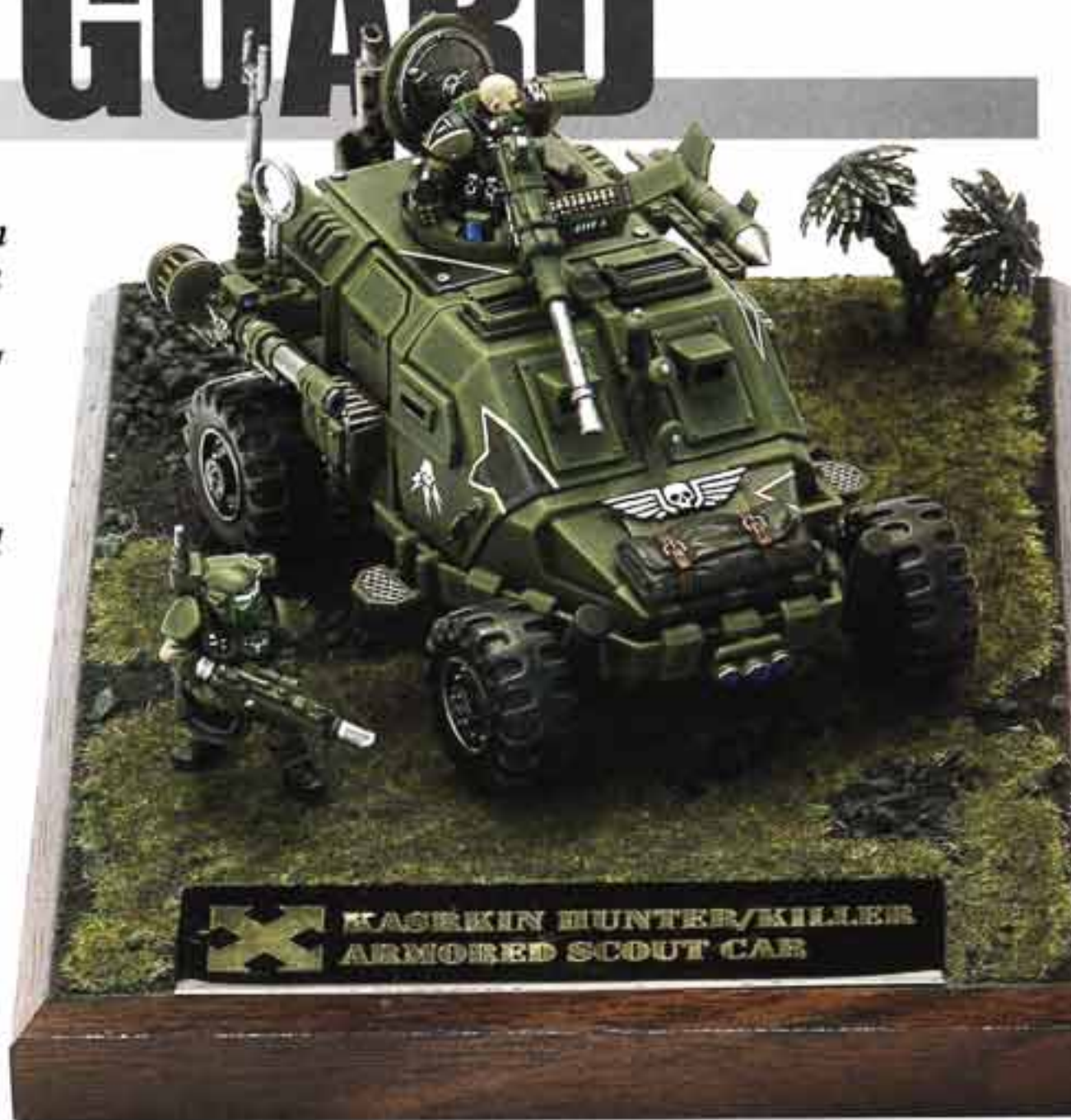

the Guard to launch terrific counterattacks. Some Imperial armies can move quickly either by streaking across the battlefield and deploying out of Chimeras or by employing fast-moving forces like Rough Riders, Sentinel Squadrons, or the flame-throwing Hellhound vehicle. Second, if an Imperial Guard player does stand back and fire, it can do so with a well thought out fire pattern of awesome artillery, heavy weapons teams, tanks, and massed firepower from the infantry squads. No enemy force can afford to disrespect the potential volume of fire that can be called down on any battlefield!

Collecting an Imperial Guard Army

As with any army, the best way to start collecting an Imperial Guard force is to establish a basic playable force. Start with some Troops choices and a leader, which will also fulfill your compulsory selections on the Standard Missions Force template. Not surprisingly, the foundation of an Imperial Guard army is the Infantry Platoon. The standard Infantry squad can be modified by extra weapon options like heavy or special weapons. These options are subtle but can be game-winning. For instance, against a numerous, but lightly armored foe like Orks, the heavy bolter would serve best, while a heavily armored enemy or one that employed

many vehicles would be better countered by a lascannon. A Command Squad is another essential for all Imperial Guard players and also another opportunity to customize with such things as weapon options, Medic, Standard Bearer, or vox-caster upgrades, or even additional characters like Commissars, Sanctioned Psykers, Priests, or even whole Support Squads.

Players looking to add onto their Imperial Guard armies have many great options, but many are first drawn to the vast range of armored fighting vehicles. From the lumbering but heavily armed Leman Russ battle tank to the fast walkers known as Sentinels, the Imperial Guard has a mighty arsenal of weaponry to choose from. A Basilisk can provide artillery support. Hellhounds can spew flame. Should any infantry squads need to be redeployed, the Chimera transport vehicle is ready to do so in a hurry. Imperial Guard commanders looking for even more troop options can go for the massed approach of a Conscript Infantry Platoon, elite Hardened Veterans and Stormtroopers, close-combat-oriented Ogryns, or the mounted support of the Rough Riders. Of course, the Imperial Guard can never get too many infantrymen, and additional Infantry Squads or Heavy Weapons Platoons are always needed. Start recruiting your army today.



Cadian Battle Force Box 99120105010

- 20 Cadian Guardsmen
- 3 Cadian Heavy Weapon Teams
- 1 Leman Russ Battle Tank
- 1 Ruined Building Set



GETTING STARTED

The 64-page Codex: Imperial Guard rulebook (Left) contains painting and modeling guides, background, and the full army list for the Imperial Guard, plus full rules for specialized troops and regimental traits to personalize your Guard to your own fighting style



**Codex:
Imperial Guard**
60030105003



Catachan Battle Force Box 99120105016

- 25 Catachan Guardsmen
- 3 Catachan Heavy Weapon Teams
- 2 Catachan Sentinels
- 1 Set of Jungle Trees



HQ



URSARKAR CREED
9947010516201

JARRAN KELL
9947010516202

Ursarkar Creed & Jarran Kell Blister (2)
99060105162



SANCTIONED PSYKER 1
9947010517301

SANCTIONED PSYKER 2
9947010517302

SANCTIONED PSYKER 3
9947010517303

Sanctioned Psykers Blister (Random 2)
99060105173

HQ



Commissar Yarrick Blister (1)
99060105149



Colonel Commissar Gaunt Blister (1)
99060105179



Colonel Schaeffer Blister (1)
99060105178



Sly Marbo is only available via Special Offer.



Sly Marbo Blister (1)
99060105143



COMMISSAR YARRICK BODY
9947010514901



GAUNT BODY
9947010516001



COLONEL SCHAEFFER BODY
9947010513301



SLY MARBO BODY
9947010514301



COMMISSAR YARRICK ACCESSORIES
9947010514902



GAUNT SWORD ARM
9947010516002



COLONEL SCHAEFFER SWORD ARM
9947010513302



SLY MARBO ARM
9947010514302



Colonel Straken is only available via Special Offer.



Colonel "Iron Hand" Straken Blister (1)
99060105139
BIT NAME: COLONEL STRAKEN
BIT CODE: 9947010513901





Imperial Commissar Blister (Random 1)
99060105019



COMMISSAR 3 BODY
9947010501904



COMMISSAR 1 BODY
9947010501906



COMMISSAR 2 BODY
9947010501901



COMMISSAR 1 ARM
9947010501907



COMMISSAR 2 SWORD ARM
9947010501902



COMMISSAR 2 BOLT GUN ARM
9947010501903



COMMISSAR 3 HAND FLAMER ARM
9947010501905



CATACHAN OFFICER 1
9947010518701

CATACHAN OFFICER 2
9947010518702

CATACHAN OFFICER 3
9947010518703

Catachan Officers Blister (Random 2)
99060105187



The Steel Legion Lieutenants are only available via Special Offer.



STEEL LEGION LIEUTENANT 1
9947010515201



STEEL LEGION LIEUTENANT 2
9947010515202

Steel Legion Lieutenant Blister (Random 1)
99060105152



Catachan Captain Blister (1)
99060105017



CATACHAN CAPTAIN BODY
9947010501701



CATACHAN CAPTAIN BOLTER
9947010501702



CATACHAN CAPTAIN BACKPACK
9947010501703





HQ

The Cadian Command Squad boxed set contains the Cadian w/ Melta Gun (9947010517201) shown in Troops with the Cadian Assault Weapons Blister.



CADIAN COMMANDER
9947010516401



Cadian Command Squad Box (6)
99110105164



CADIAN COMMLINK OPERATOR
9947010516404



CADIAN COMM-LINK
9947010516405



CADIAN CASUALTY
9947010516406



CADIAN STANDARD BEARER
9947010516402



CADIAN MEDIC
9947010516403

Cadian Medic & Standard Bearer Blister (2)
99060105169

CADIAN TRANSFER SHEET											
812	812	812	812	812	812	812	812	812	812	812	1166
265	265	265	265	265	265	265	265	265	265	265	265
190	190	190	190	190	190	190	190	190	190	190	190
501	501	501	501	501	501	501	501	501	501	501	501
728	728	728	728	728	728	728	728	728	728	728	728
450	450	450	450	450	450	450	450	450	450	450	450
317	317	317	317	317	317	317	317	317	317	317	317
541	541	541	541	541	541	541	541	541	541	541	541
609	609	609	609	609	609	609	609	609	609	609	609
144	144	144	144	144	144	144	144	144	144	144	144
812	812	812	812	812	812	812	812	812	812	812	812
265	265	265	265	265	265	265	265	265	265	265	265
190	190	190	190	190	190	190	190	190	190	190	190
501	501	501	501	501	501	501	501	501	501	501	501
728	728	728	728	728	728	728	728	728	728	728	728
450	450	450	450	450	450	450	450	450	450	450	450
317	317	317	317	317	317	317	317	317	317	317	317
541	541	541	541	541	541	541	541	541	541	541	541
609	609	609	609	609	609	609	609	609	609	609	609
144	144	144	144	144	144	144	144	144	144	144	144
Imperialis Dominatus	CADIA	CADIA	CADIA	CADIA	CADIA	CADIA	CADIA	CADIA	CADIA	CADIA	CADIA
Sepulchra Metallica	CADIA	CADIA	CADIA	CADIA	CADIA	CADIA	CADIA	CADIA	CADIA	CADIA	CADIA
Mechanicus Deus	CXXII	CXXII	CXXII	CXXII	CXXII	CXXII	CXXII	CXXII	CXXII	CXXII	CXXII
Nomine Imperator	EXXII	EXXII	EXXII	EXXII	EXXII	EXXII	EXXII	EXXII	EXXII	EXXII	EXXII
Mactis Ordinator	MEXI	MEXI	MEXI	MEXI	MEXI	MEXI	MEXI	MEXI	MEXI	MEXI	MEXI
Monum. Gloriam VII	VII	VII	VII	VII	VII	VII	VII	VII	VII	VII	VII

CADIAN DECAL SHEET
99510105005

All dimensions are supplied unposed. Models, bits, and sprues are all shown actual size unless otherwise noted. Contents may vary slightly from those shown.



Cadian Heavy Weapon Squad Box (3 Teams)
99120105009



Cadian Heavy Weapon Team Box (1 Team)
99120105012



The Cadian Heavy Weapon Teams include the Cadian Decal Sheet (99510105005) shown on the opposite page.

HQ

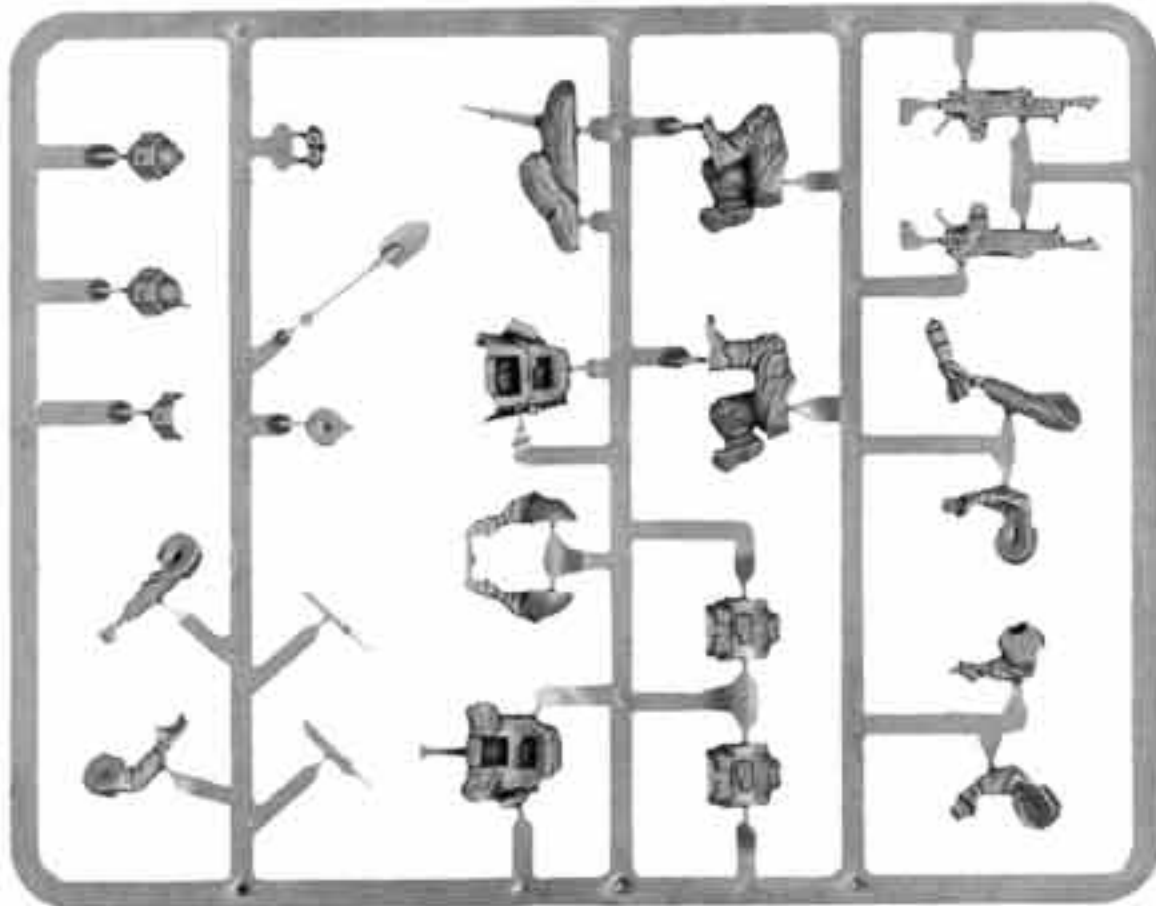

CADIAN HEAVY WEAPON CREW SPRUE (SHOWN 70% ACT. SIZE)
99380105004

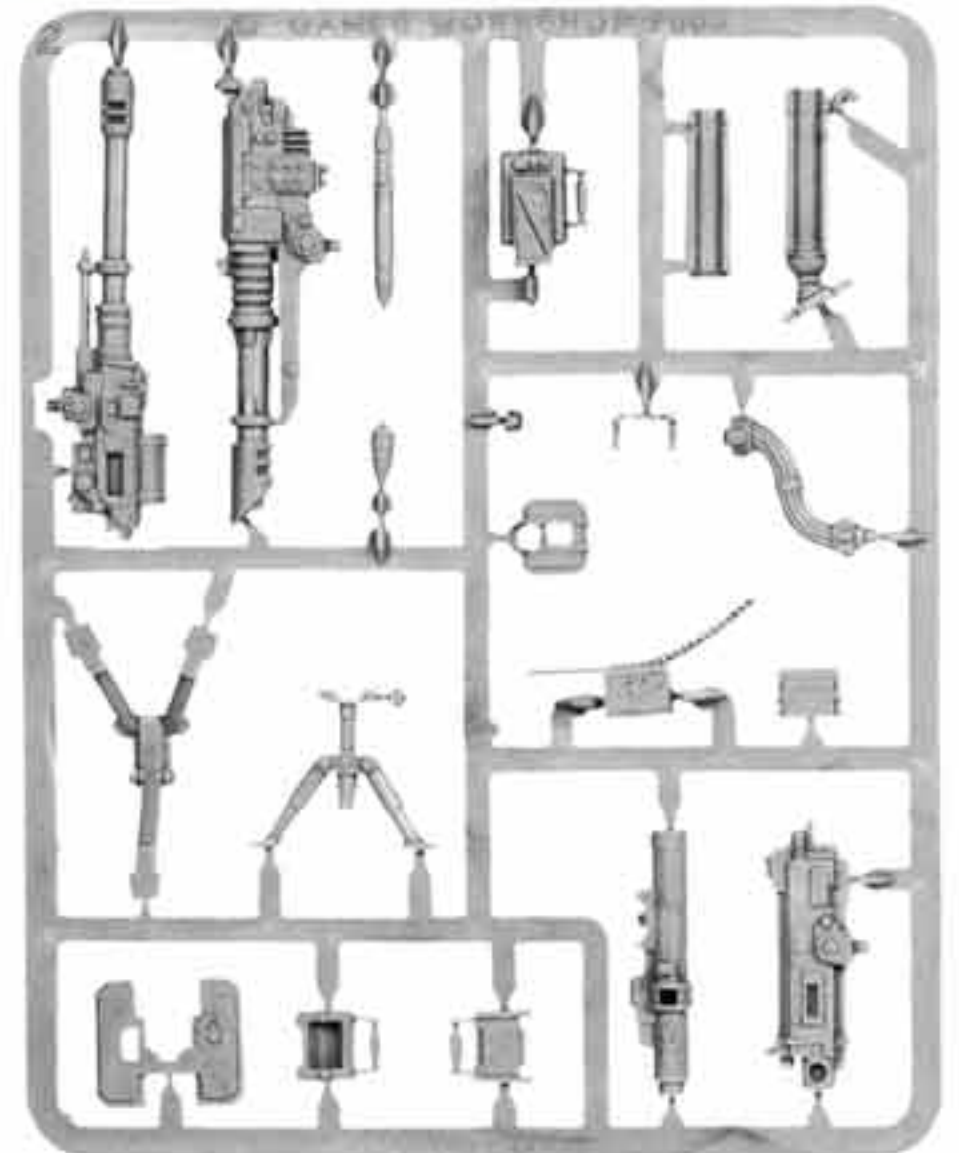

IMPERIAL GUARD HEAVY WEAPON SPRUE (SHOWN 70% ACT. SIZE)
99380105003



CADIAN OFFICER 1
9947010516601

CADIAN OFFICER 2
9947010516602

CADIAN OFFICER 3
9947010516603

CADIAN OFFICER 4
9947010516604

CADIAN OFFICER 5
9947010516605

CADIAN OFFICER 6
9947010516606

Cadian Officer Blister (Random 2)
99060105166



HQ



Catachan Heavy Flamers Blister (2)
99060105140



CATACHAN HEAVY FLAMER
9947010514003



CATACHAN HEAVY FLAMER BODY 1
9947010514001



CATACHAN HEAVY FLAMER BODY 2
9947010514002



Catachan Heavy Weapon Squad Box (3 Teams)
99120105014



Catachan Heavy Weapon Team Box (1 Team)
99120105017

The Catachan Heavy Weapon boxed sets include the Imperial Guard Heavy Weapon Sprue (99380105003) shown on the previous page.

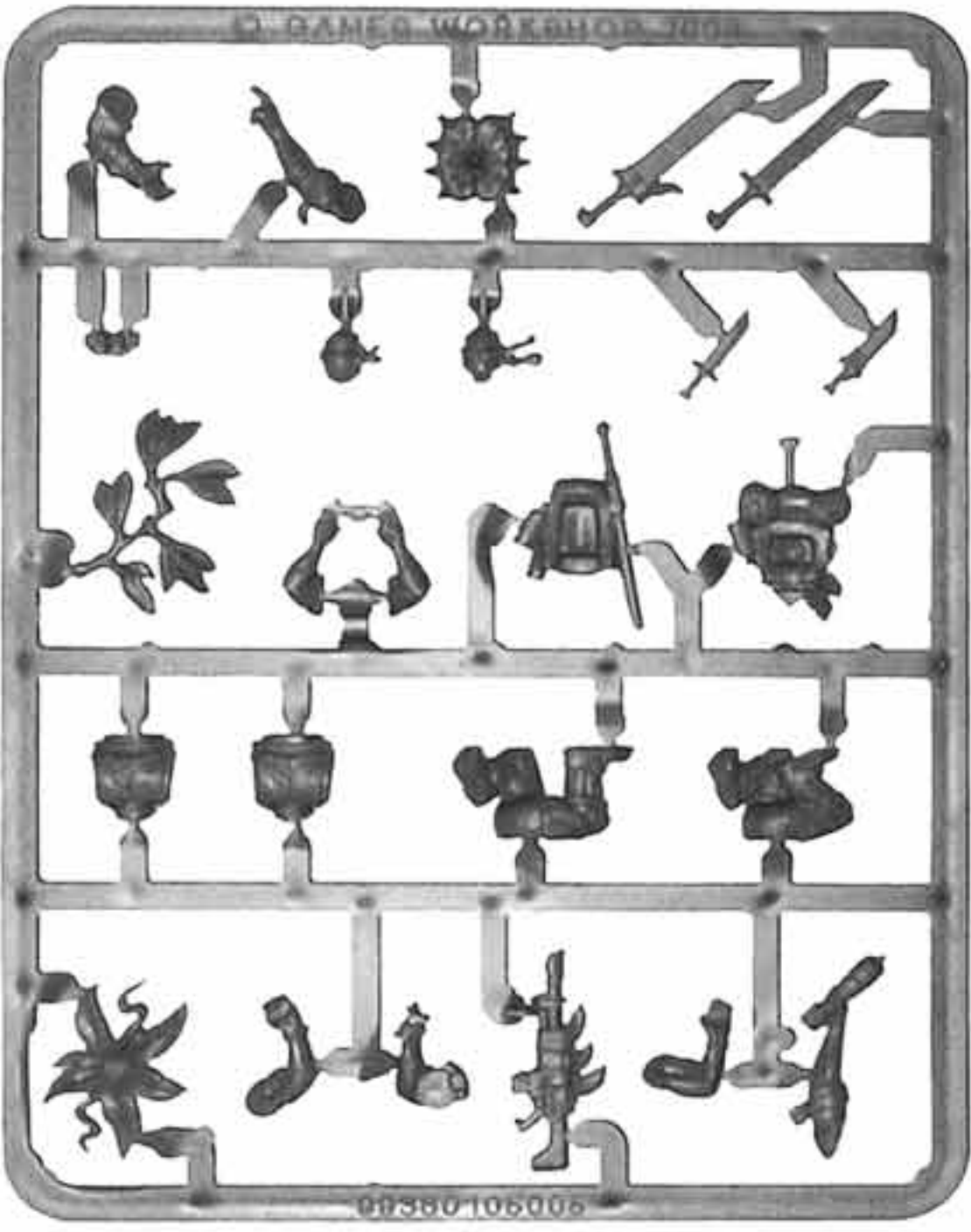

CATACHAN HEAVY WEAPON CREW SPRUE
99380105005



Steel Legionnaire Lascannon Team Blister (1 Team)
99060105157



Steel Legionnaire Heavy Weapon teams are only available via Special Offer.



Steel Legionnaire Heavy Bolter Team Blister (1 Team)
99060105156



Steel Legionnaire Missile Launcher Team Blister (1 Team)
99060105154



LASCANNON GUNNER
9947010515701



LASCANNON LOADER
9947010515702



HEAVY BOLTER GUNNER
9947010515601



HEAVY BOLTER LOADER
9947010515602



MISSILE LAUNCHER LOADER
9947010514810



MISSILE LAUNCHER GUNNER
9947010514811



LASCANNON POWER PACK
9947010515703



LASCANNON TRIPOD FRONT
9947010515704



HEAVY BOLTER
9947010515603



HEAVY BOLTER BI POD
9947010515604



MISSILE LAUNCHER
9947010514812



LOADER BACKPACK
9947010514813



LASCANNON
9947010515705

Imperial Servitors can be found in the Inquisition section.



Tech-Priest Engineers Blister (Random 1)
99060105175

Always endeavor to fight the enemy on your terms. If you are powerful at close quarters, then engage in dense terrain where your advantage will prove greatest. If you are superior at long range, then fight the battle at a distance. No one ever won a battle who failed to take advantage of his enemy's weakness.

The Tactica Imperium



ENGINEER POWER AXE 1
9947010517503



ENGINEER POWER AXE 2
9947010517504



ENGINEER BACKPACK ARM
9947010517505



ENGINEER BODY 1
9947010517501



ENGINEER BODY 2
9947010517502



ENGINEER BACKPACK
9947010517506

ELITES



The Cadian Kasrkin boxed set includes the Cadian Decal Sheet (99510105005) shown in HQ. Stormtroopers can be found in the Inquisition section.



CADIAN KASRKIN BACKPACK
9947010516502



CADIAN KASRKIN FLAMER BACKPACK
9947010517005



CADIAN KASRKIN GRENADE LAUNCHER BACKPACK
9947010517006



Cadian Kasrkin Squad Box (10)
99110105165



CADIAN KASRKIN 1
9947010516503



CADIAN KASRKIN 2
9947010516504



CADIAN KASRKIN 3
9947010516505



CADIAN KASRKIN 4
9947010516506



CADIAN KASRKIN FLAMER
9947010517001



CADIAN KASRKIN GRENADE LAUNCHER
9947010517002



Cadian Kasrkin w/ Special Weapons Blister (2)
99060105170

The Kasrkin Sergeant blister includes the Cadian Kasrkin Backpack (9947010516502).



CADIAN KASRKIN MELTA GUN BACKPACK
9947010517007



Kasrkin Sergeant Blister (1)
99060105184



CADIAN KASRKIN MELTA GUN
9947010517003



CADIAN KASRKIN PLASMA GUN
9947010517004



CADIAN KASRKIN PLASMA GUN BACKPACK
9947010517008



KASRKIN SERGEANT
9947010516501

ELITES



CATACHAN SNIPER 1
9947010514201

CATACHAN SNIPER 2
9947010514202

CATACHAN SNIPER 3
9947010514203

Catachan Sniper Blister (Random 3)
99060105142



CADIAN SNIPER 1
9947010517601

CADIAN SNIPER 2
9947010517602

Cadian Sniper Blister (Random 2)
99060105176



RATLING 1
9947010501203

RATLING 2
9947010501205

RATLING 3
9947010501202

RATLING 4
9947010501204

RATLING 5
9947010501206

RATLING 6
9947010501201

Ratling Sniper Blister (Random 5)
99060105012



CATACHAN DEMOLITION CHARGE 1
9947010514401

CATACHAN DEMOLITION CHARGE 2
9947010514402

Catachan Demolition Charges Blister (2)
99060105144



Ogryn w/ Ripper Gun Blister (Random 1)
99060105043



OGRYN BODY 1
9947010504306

OGRYN BODY 2
9947010504307

OGRYN BODY 3
9947010504310



OGRYN HEAD 1
9947010504303



OGRYN HEAD 2
9947010504301



OGRYN HEAD 3
9947010504302



OGRYN LEGS 1
9947010504304

OGRYN LEGS 2
9947010504305



OGRYN GUN 1
9947010504309



OGRYN GUN 2
9947010504308



OGRYN GUN 3
9947010504311



TROOPS



The Cadian Shock Troops boxed set includes the Cadian Decal Sheet (99510105005) shown in HQ.



Cadian Shock Troops Box (20)
99120105008



CADIAN W/ MELTA GUN
9947010517201



CADIAN W/ PLASMA GUN
9947010517202

Cadian w/ Assault Weapons Blister (2)
99060105172

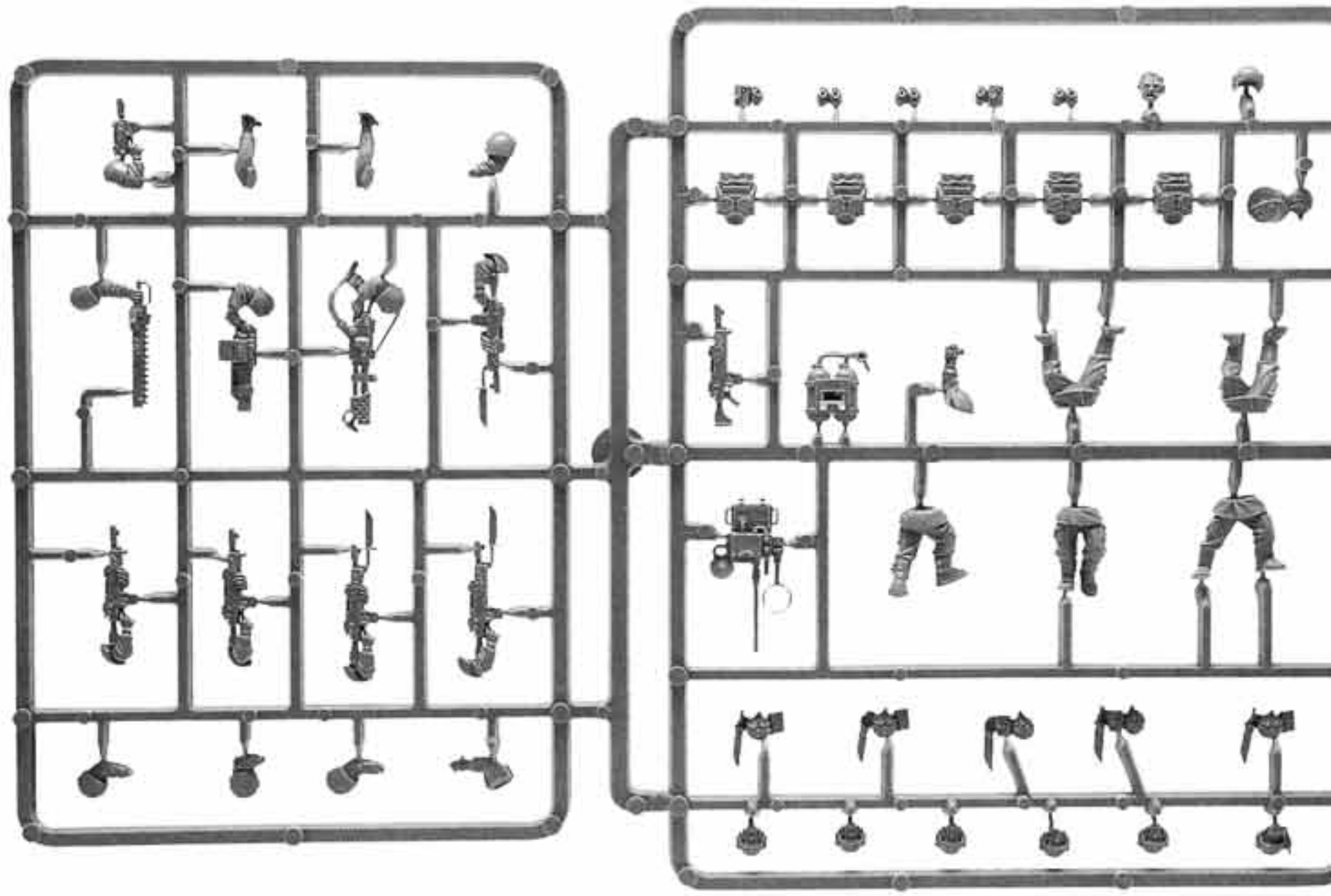

CADIAN SHOCK TROOP SPRUE (SHOWN 60% ACTUAL SIZE)
99380105002

TROOPS



Catachan Jungle Fighters Squad Box (20)
99120105004

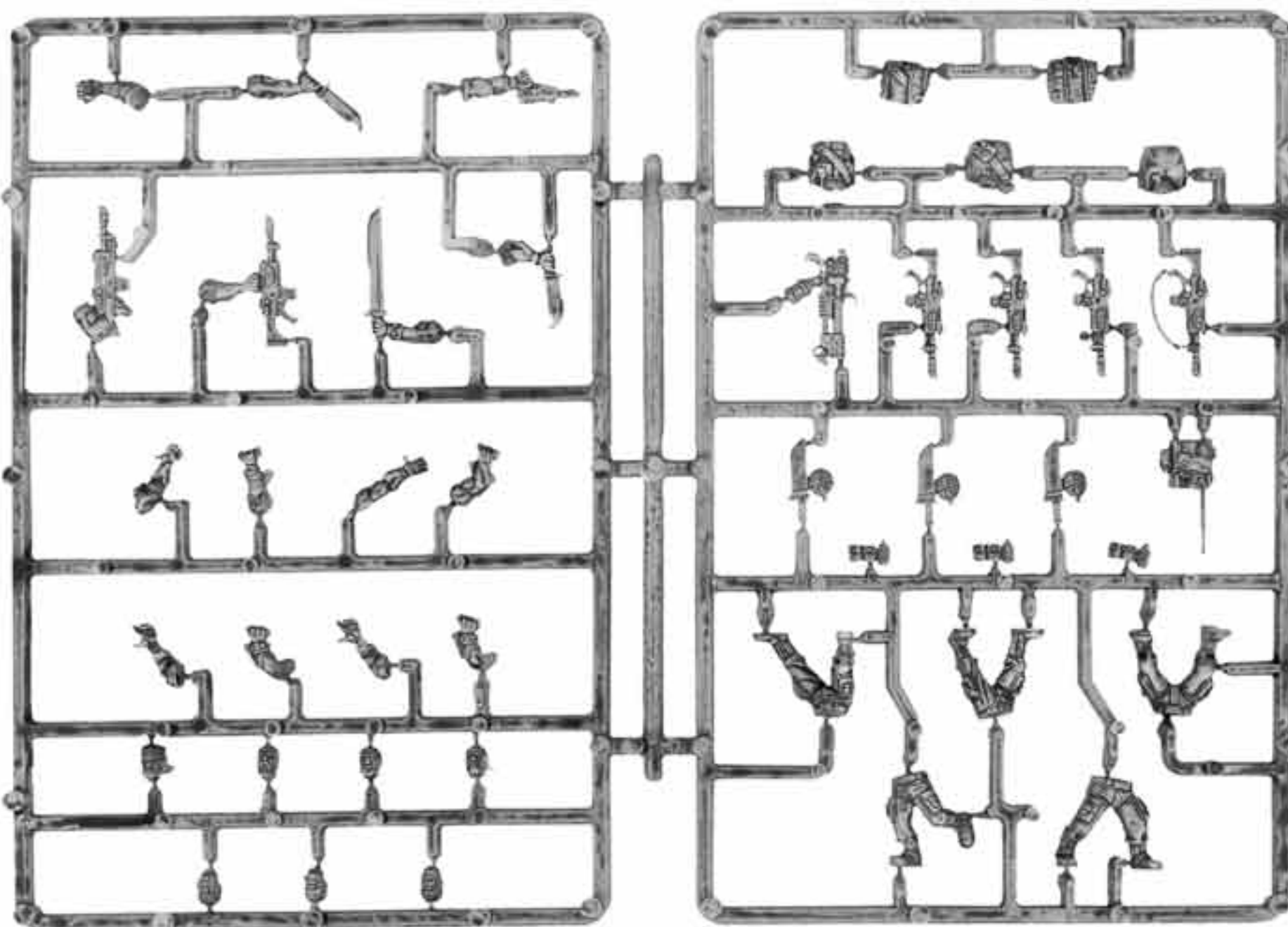

CATACHAN JUNGLE FIGHTER SPRUE (SHOWN 60% ACTUAL SIZE)
99380105001



CATACHAN W/ MELTA GUN
9947010504806

CATACHAN W/ FLAMER
9947010505612

Catachan w/ Assault Weapons Blister (2)
99060105061





TROOPS



Armageddon Steel Legion Squad Box (10)
99110105148

The Armageddon Steel Legion Squad boxed set includes the missile launcher bitz found in the Steel Legion Missile Launcher Team blister (99060105154) shown in HQ. The Steel Legionnaire with Assault Weapon and Sergeant bitz for this boxed set can be found on the opposite page.



STEEL LEGIONNAIRE 1
9947010514804

STEEL LEGIONNAIRE 2
9947010514805

STEEL LEGIONNAIRE 3
9947010514806

STEEL LEGIONNAIRE 4
9947010514807

STEEL LEGIONNAIRE 5
9947010514808

STEEL LEGIONNAIRE 6
9947010514809

Steel Legionnaire Troopers Blister (Random 3)
99060105155

TROOPS



Steel Legionnaire Sergeant Blister (Random 1)
99060105181



STEEL LEGION SERGEANT 2 BODY
9947010514801



STEEL LEGION SERGEANT 1 BODY
9947010515301



STEEL LEGION SERGEANT 1 ARM
9947010515302



STEEL LEGION SERGEANT 2 ARM
9947010514802



STEEL LEGIONNAIRE W/ GRENADE LAUNCHER
9947010514803

STEEL LEGIONNAIRE W/ PLASMA GUN
9947010515303

Steel Legionnaire w/ Assault Weapons Blister (2)
99060105180



Tanith Ghosts are only available via Special Offer.



TANITH GHOST 1
9947010516101



TANITH GHOST 2
9947010516102



TANITH GHOST 3
9947010516103



TANITH GHOST 4
9947010516104

Tanith Ghosts Blister (Random 3)
99060105161

POSING THE BASIC GUARDSMEN

The first things to think about as you assemble a new set of models are their poses. The most basic part of the pose is the position of the legs on the base.



Below, the model is positioned toward the back of its base with most of the space to the front. This position helps to create a sense of forward motion and helps balance the weight of the model.

Example: By making the initial decision to set the model further back on the base, the illusion of speed is generated.



The design of the models means that the weapon arms fit comfortably in only one position. This position makes matching up the gun arm with the supporting arm easier. It's a good idea to attach the weapon arm first and then the supporting arm straight away. By using polystyrene cement, you give yourself a little time to adjust the arms if they don't meet perfectly. To get an idea of what the different arms look like on a finished model, take a look at the photos of models throughout this section of the catalog, in *White Dwarf* magazine, or on the Games Workshop web site.



One thing to keep in mind when putting the models together is to keep the pose natural. A good way to check this out is just to stick the parts of the model together with Blu-Tac before you go ahead with the gluing. This step gives you a chance to see how the model will look before you start gluing. You could even try taking up a pose yourself to get the feel of how a real person would stand. The models above show two very naturalistic poses.



TROOPS



Imperial Guard Chimera Box (1)
99120105013

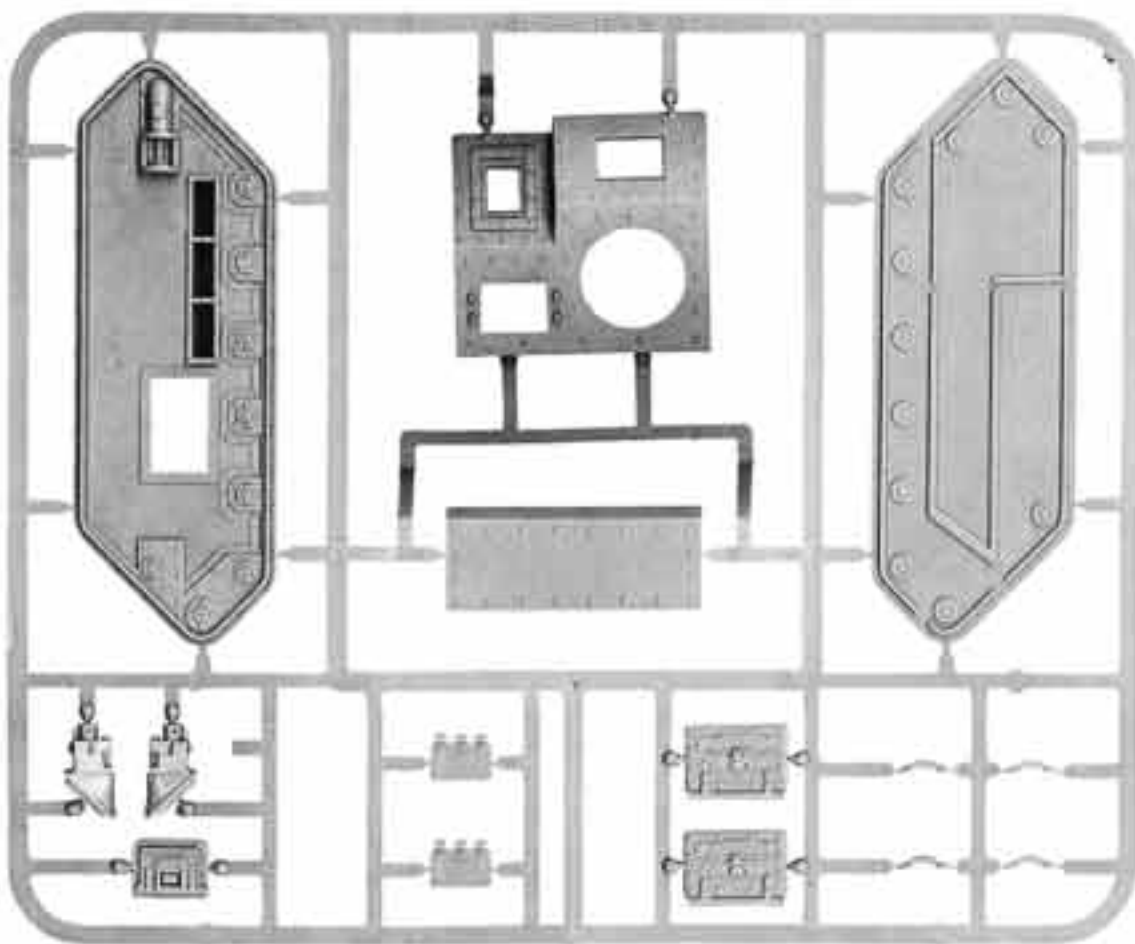

CHIMERA HULL B (SHOWN 40% ACTUAL SIZE)
99399999046

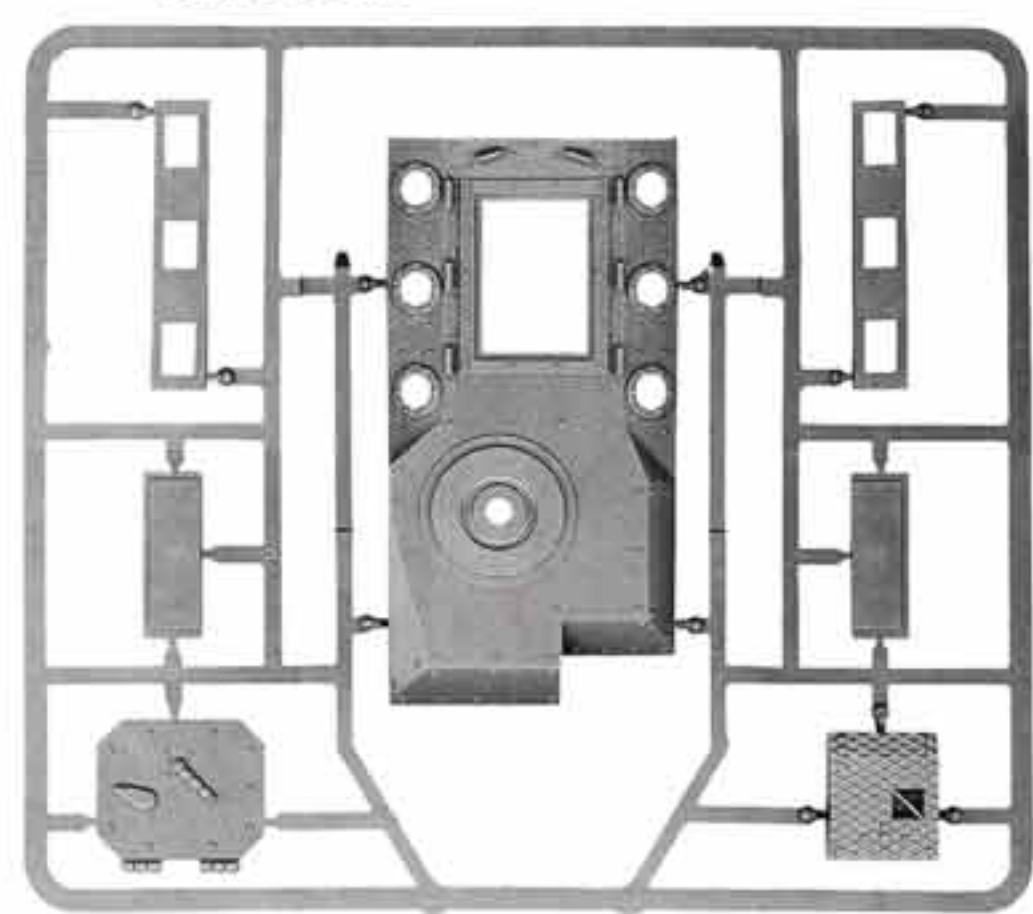

CHIMERA HULL D (SHOWN 40% ACTUAL SIZE)
99399999048

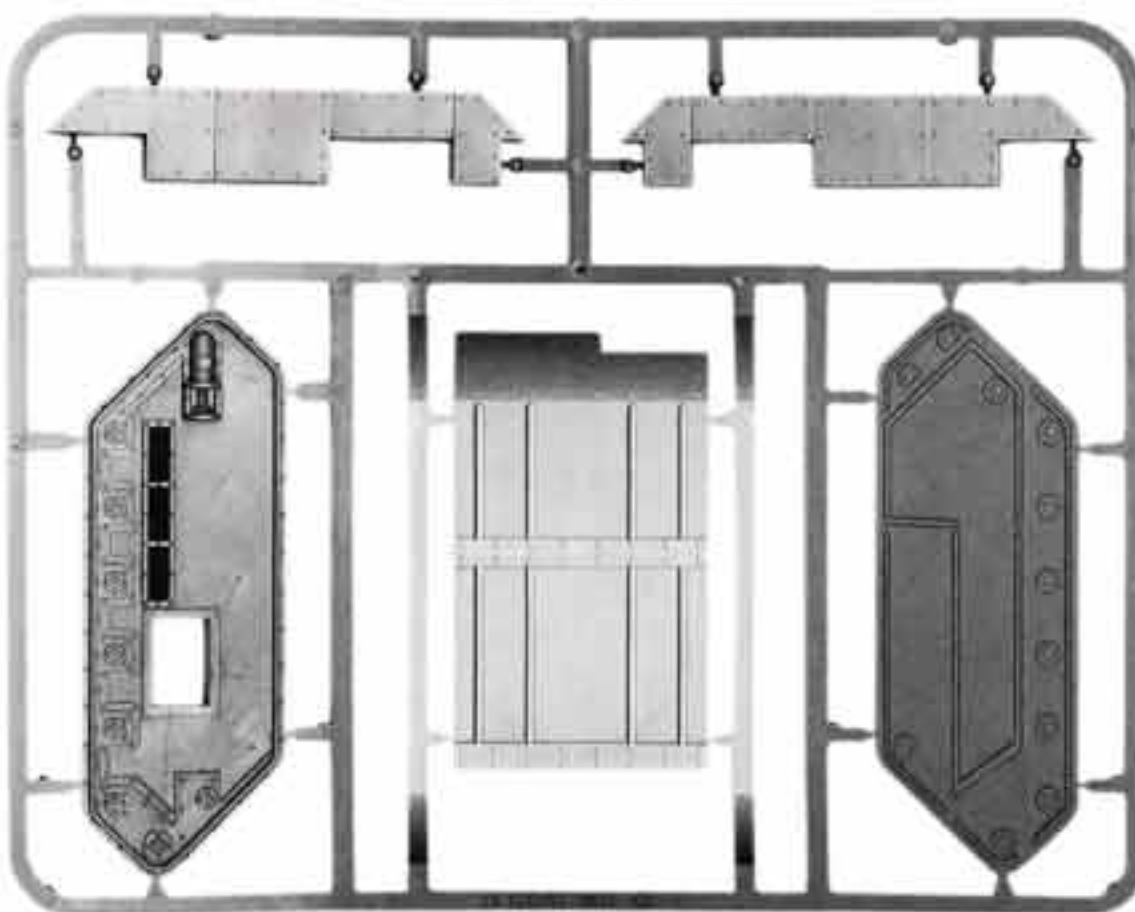

CHIMERA HULL C (SHOWN 40% ACTUAL SIZE)
99399999047

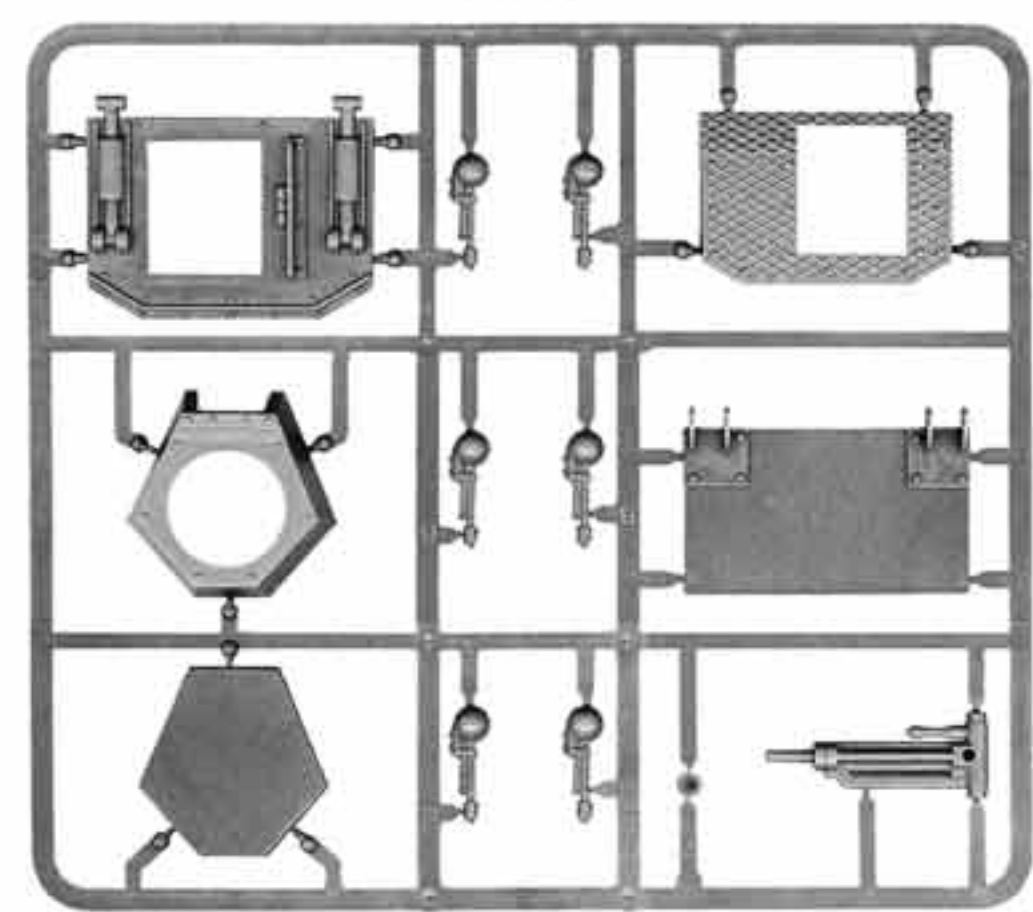

CHIMERA HULL E (SHOWN 40% ACTUAL SIZE)
99399999050

All measures are supplied unrounded. Models, kits and sprues are all shown actual size unless otherwise noted. Contents may vary slightly from those shown.

TROOPS

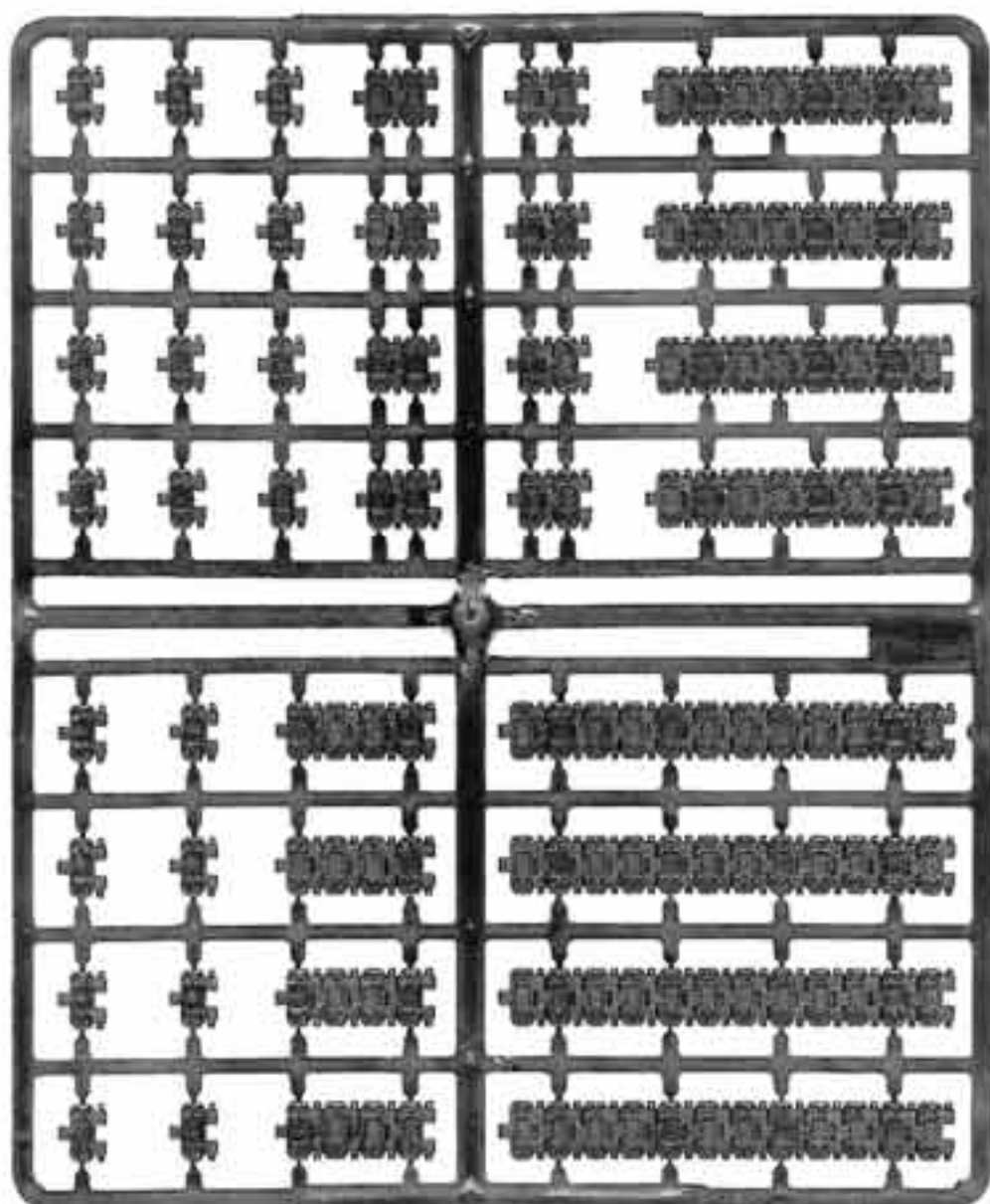

TANK TRACK SPRUE (SHOWN 50% ACTUAL SIZE)
99399999042

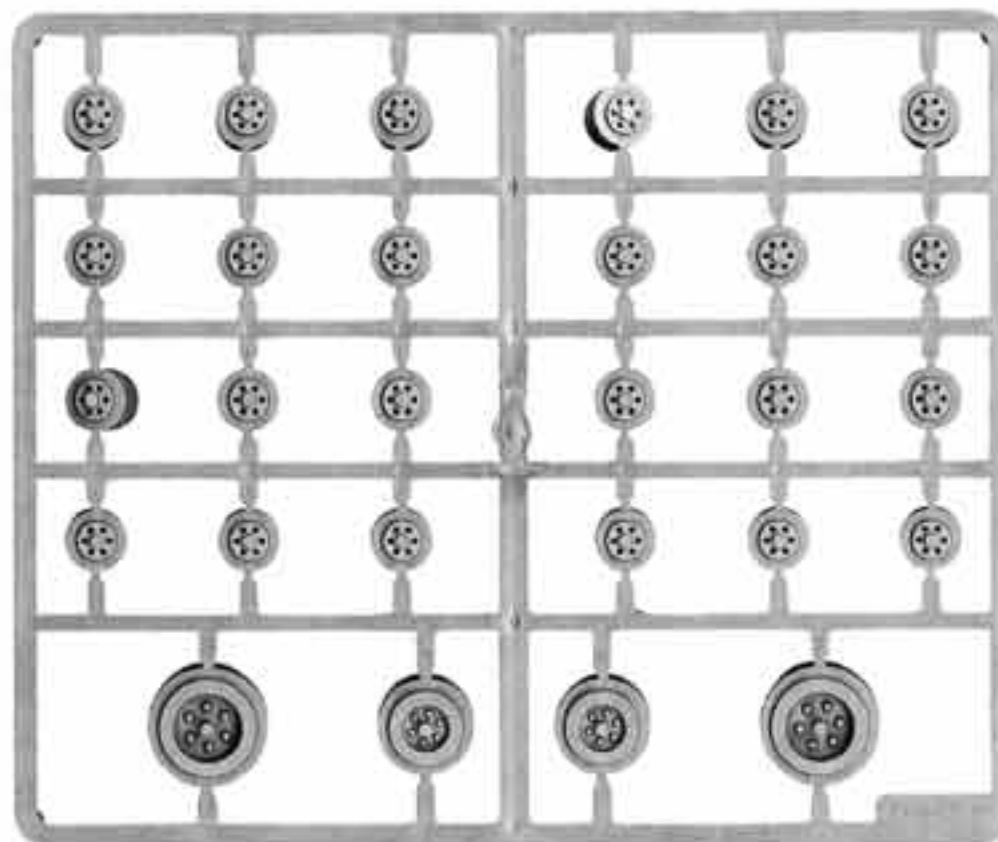

TANK WHEEL SPRUE (SHOWN 50% ACTUAL SIZE)
99399999043

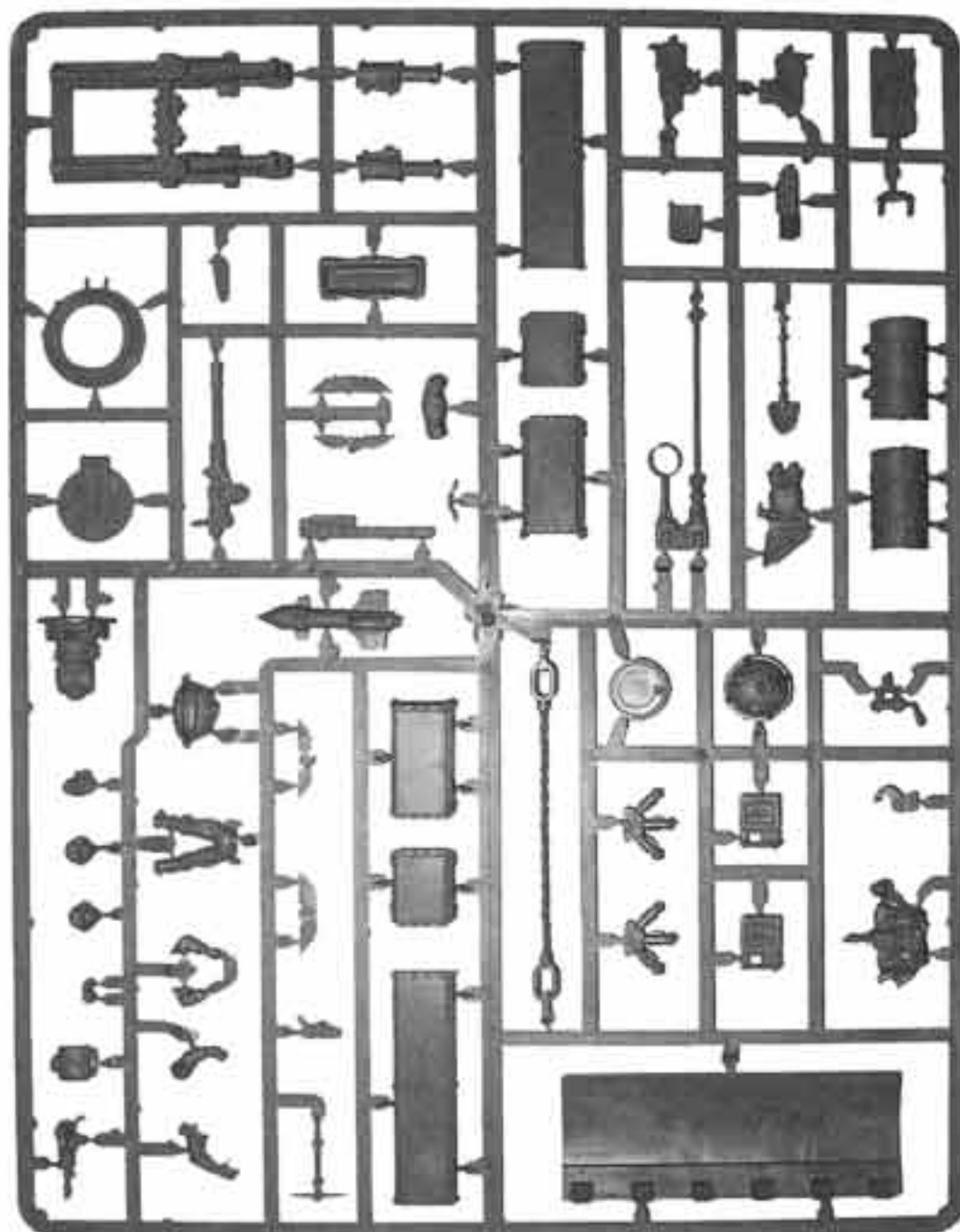

IMPERIAL TANK ACCESSORY SPRUE (SHOWN 50% ACTUAL SIZE)
99390105003

IMPERIAL GUARD TANK TRANSFERS

1 2 3 4 5 6 7 8 9 0
1 2 3 4 5 6 7 8 9 0

A B C
ID: 754621.41 **ARMAGEDDON**
VALHALLA 07968 057152 III II II II III III III
CATACHAN ALPHA CADIA IV IV IV VVV XXX

TALLARN TURAN MORDIAN RYZA
[JUSTUS EXTREMIS ARMOUR]CUM MORTIS IMPERIUS METALLUS KILL!
© Games Workshop Ltd. 2000. COMPONENT Number: 99 51 01 05 004

IMPERIAL GUARD DECAL SHEET
99510105004



FAST ATTACK

The Imperial Hellhound boxed set includes Imperial Guard Decal Sheet (99510105004), Imperial Tank Track Sprue (99399999042), Imperial Tank Wheels Sprue (99399999043), and Chimera Hulls B, C, D, and E (99399999046, 47, 48, 50) shown with the Imperial Guard Chimera.

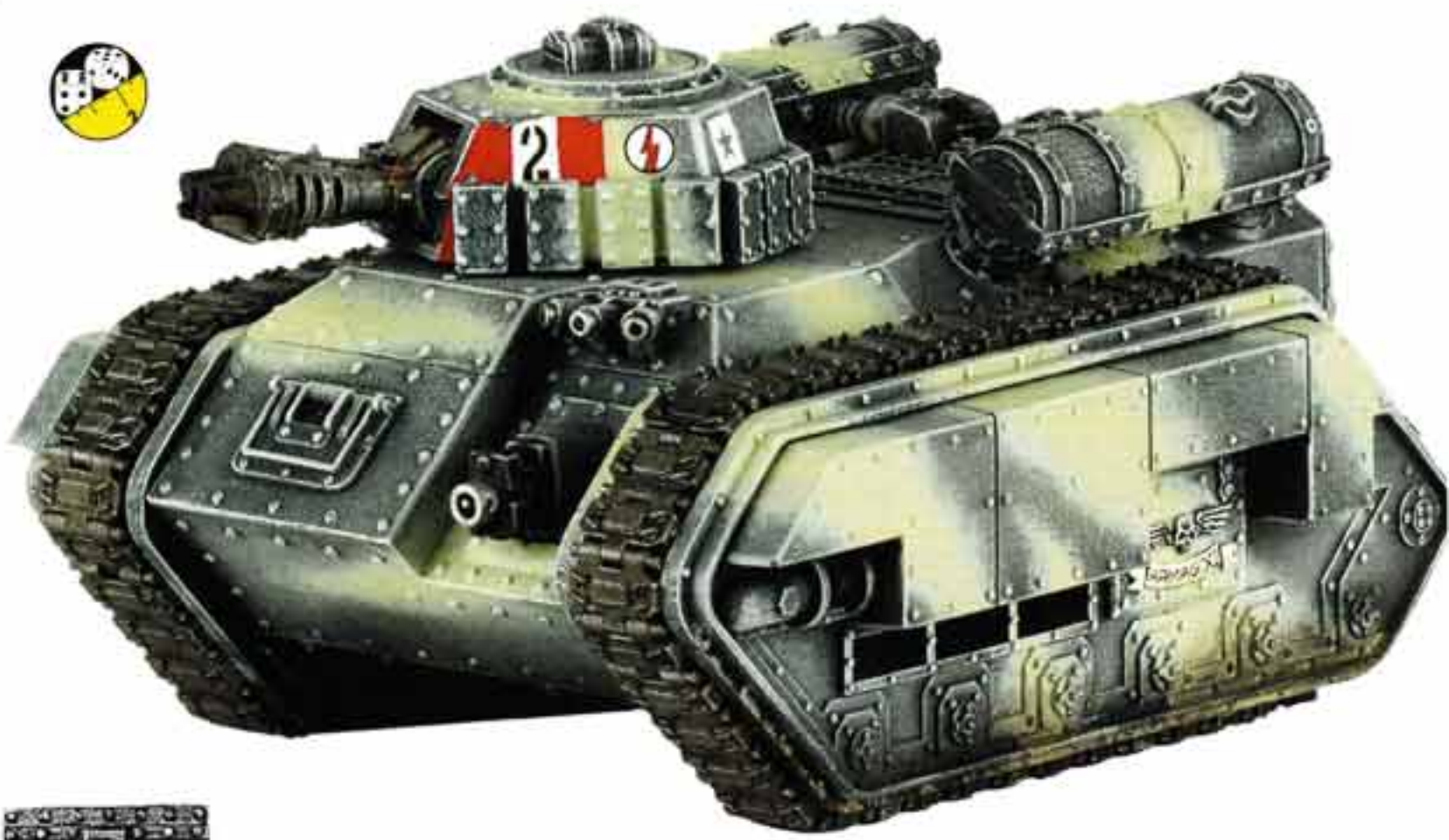

Imperial Hellhound Box (1)
99140105055



HELLHOUND TURRET BOTTOM
9947010505501



HELLHOUND TOP PLATE
9947010505502



HELLHOUND INFERNO CANNON
9947010505503



HELLHOUND TARGETING CUPOLA
9947010505504



HELLHOUND FUEL TANK BOTTOM
9947010505505

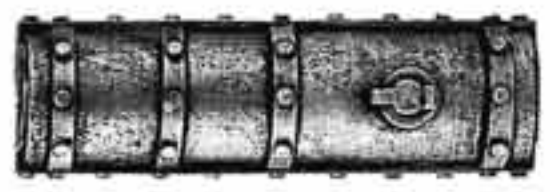

HELLHOUND FUEL TANK TOP
9947010505506



HELLHOUND SMALL TURRET PLATE
9947010505507

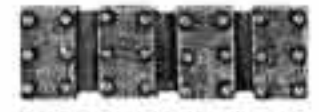

HELLHOUND LARGE TURRET PLATE
9947010505508



HELLHOUND FUEL HOSE
9947010505509

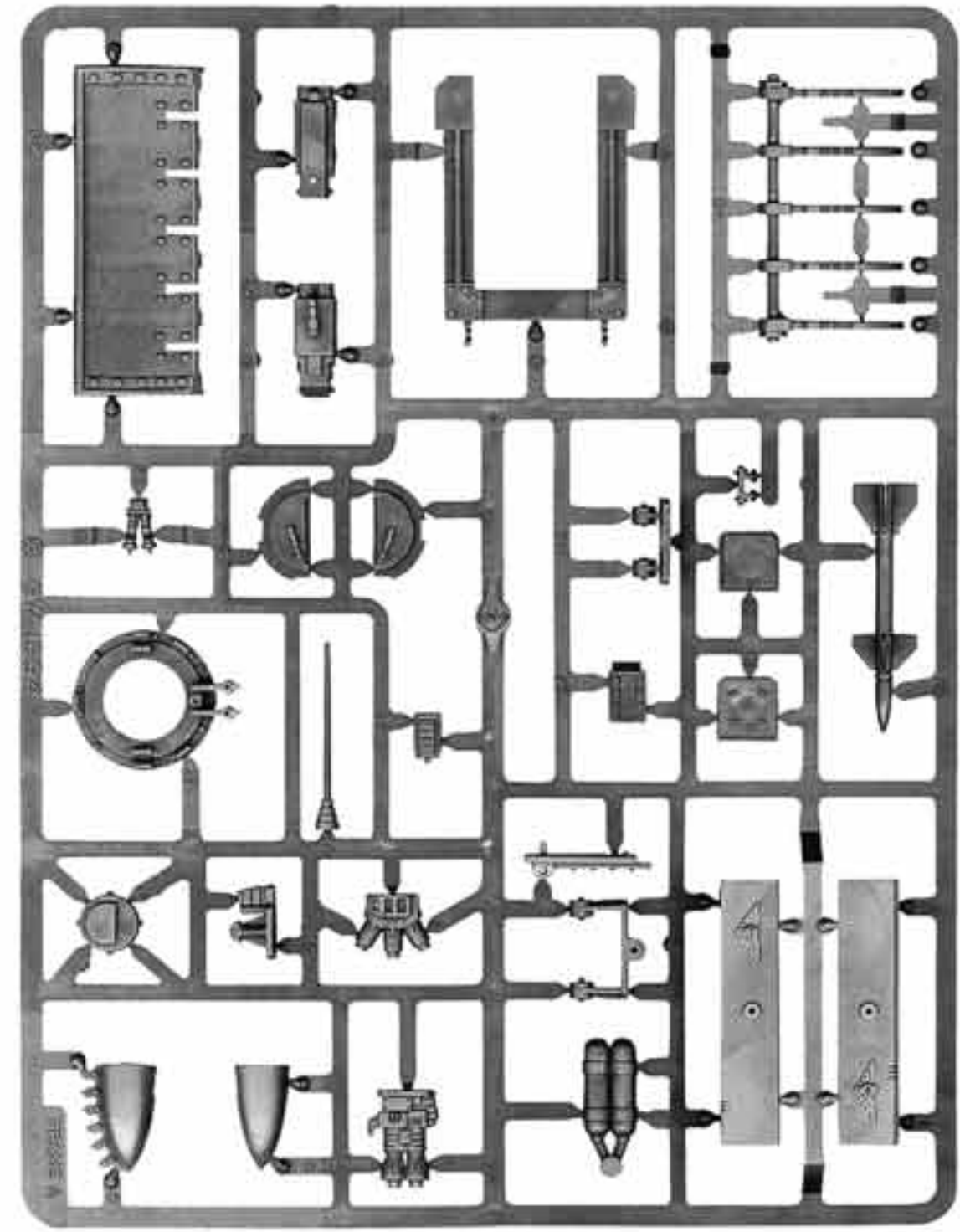

IMPERIAL TANK ACCESSORY SPRUE A (SHOWN 60% ACTUAL SIZE)
99399999035

FAST ATTACK



Rough Rider Blister (Random 1)
99060105044



ROUGH RIDER HUNTING LANCE
9947010504406



MEDIEVAL HORSE BODY SPRUE
99389999003



MEDIEVAL HORSE HEAD SPRUE
99389999013

Both the Rough Rider blister and Rough Rider Command blister include the Medieval Horse Body and Head Sprues.



ROUGH RIDER LIEUTENANT BODY
9947010505201



ROUGH RIDER LIEUTENANT ARM
9947010505202



ROUGH RIDER LIEUTENANT HUNTING LANCE
9947010505203



Rough Rider Command Blister (1)
99060105145



ROUGH RIDER TORSO 1
9947010504401



ROUGH RIDER TORSO 2
9947010504402



ROUGH RIDER TORSO 3
9947010504403



ROUGH RIDER HUNTING 1
9947010504405



ROUGH RIDER LEGS 2
9947010504404

HEROES OF THE 24TH MACHARIAN

The Macharian 24th PDF was the inspiration for this Veteran squad. This regiment from one of the planets in the Cadian sector is known for its devotion to Solar Macharius, their planet's namesake.



The squad consists of the decorated heroes of the Macharian 24th. Although their weapons are very personalized, their uniforms are still standard. The main additions are the Imperial Scripture embroidery and purity seals. These additions show that these troops are the most devout followers of Imperial Scripture in the sector and have proven their faith in battle.

All kinds of plastic and metal components were used with the Sergeant (shown below) as well as purity seals made from green stuff. The halo, made from an Ork shoulder pad, reflects the extreme purity and devotion of the Sergeant.





FAST ATTACK

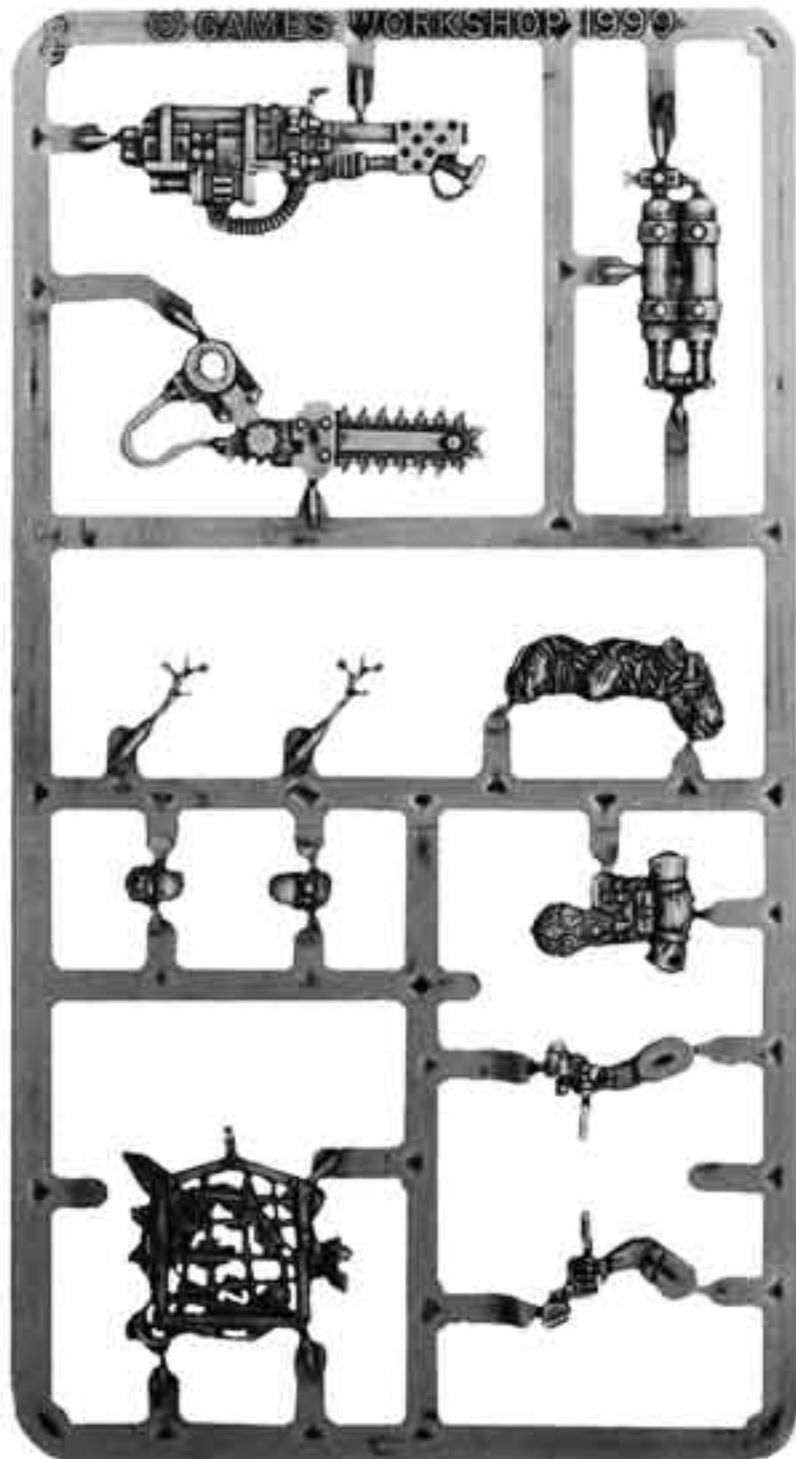

CATACHAN SENTINEL ACCESSORY
SPRUE (SHOWN 60% ACTUAL SIZE)
99390105002



Imperial Guard Sentinel Box (1)
99120105007

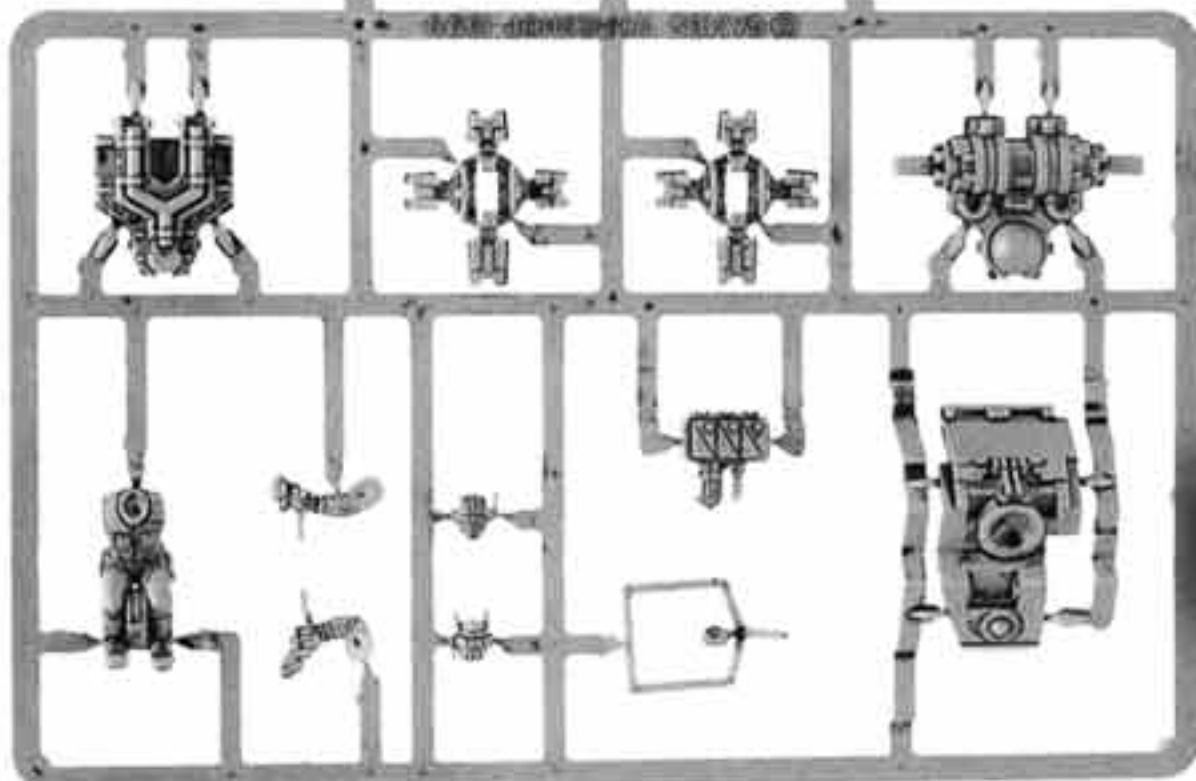
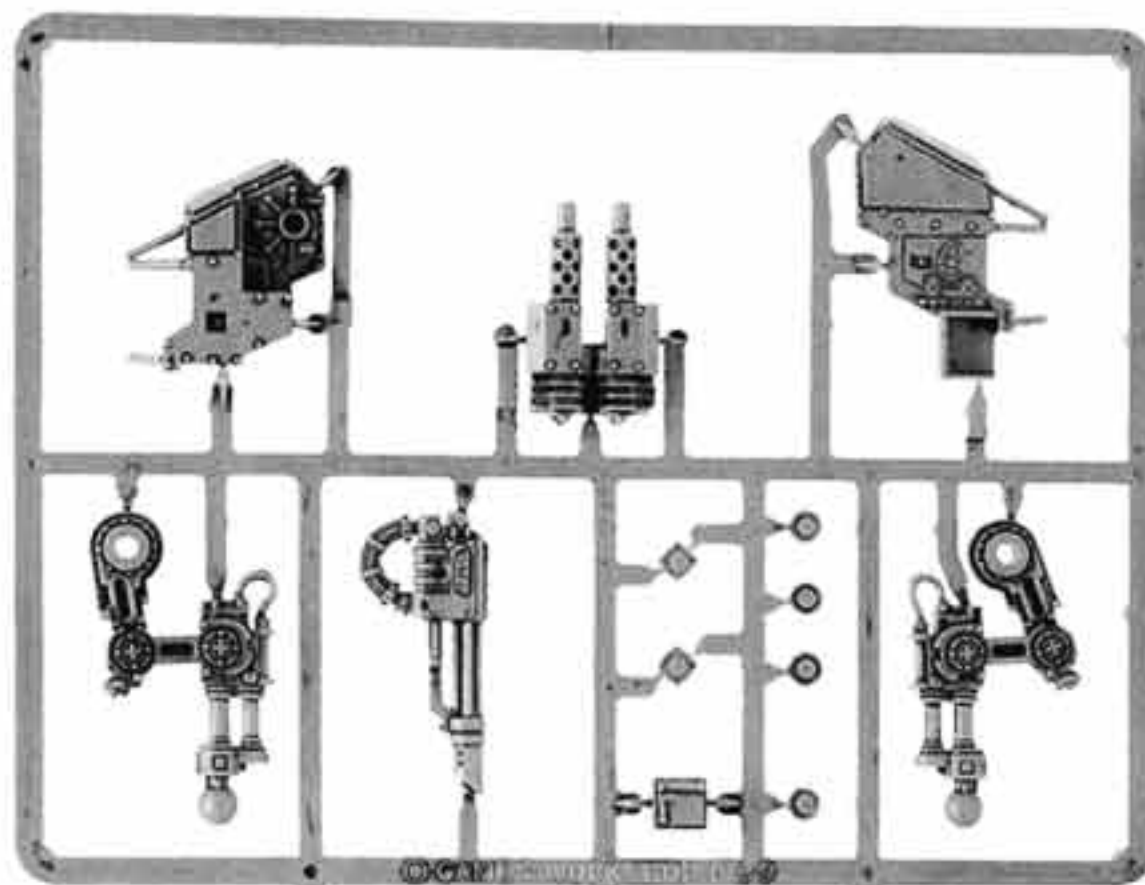

IMPERIAL GUARD SENTINEL SPRUE (SHOWN 60% ACTUAL SIZE)
99390105001

The Imperial Guard Sentinel boxed set includes bits to create an Imperial Guard Sentinel or a Catachan Sentinel (shown to the left).



FAST ATTACK



The Steel Legion Sentinel boxed set includes the Imperial Guard Sentinel Sprue shown on the opposite page and the Imperial Guard Decal Sheet (99510105004) shown with the Chimera.



Steel Legion Sentinel Box (1)
99140105151



STEEL LEGION SENTINEL AERIAL
9947010515101



STEEL LEGION SENTINEL SHIELD
9947010515106



STEEL LEGION SENTINEL SIGHT
9947010515104



STEEL LEGION SENTINEL CANOPY
9947010515102



STEEL LEGION SENTINEL LASCANNON
9947010515103



STEEL LEGION SENTINEL POWER PACK
9947010515105



The Cadian Sentinel boxed set includes the Imperial Guard Sentinel Sprue shown on the opposite page and the Cadian Decal Sheet (99510105005) in HQ.



CADIAN SENTINEL FRONT
9947010516801



CADIAN SENTINEL PLATE
9947010516802



Cadian Sentinel Box (1)
99140105168



CADIAN SENTINEL VISION SLITS
9947010516804



CADIAN SENTINEL HEAD
9947010516805



CADIAN SENTINEL TARPULIN
9947010516808



CADIAN SENTINEL PACK
9947010516807



CADIAN SENTINEL TURRET
9947010516803



CADIAN SENTINEL AUTOCANNON
9947010516806



HEAVY SUPPORT

The Basilisk Tank boxed set includes Chimera Hull B and C (9939999046-7), Imperial Tank Accessory Sprue (99390105003), Imperial Tank Track and Wheels Sprues (99399999042-3), and Imperial Guard Decal Sheet (99510105004) shown with the Chimera. It also includes Cadian Heavy Weapon Crew Sprue (99380105004) shown in HQ.



Basilisk Tank Box (1)
99120105015



Basilisk shown smaller than actual size.

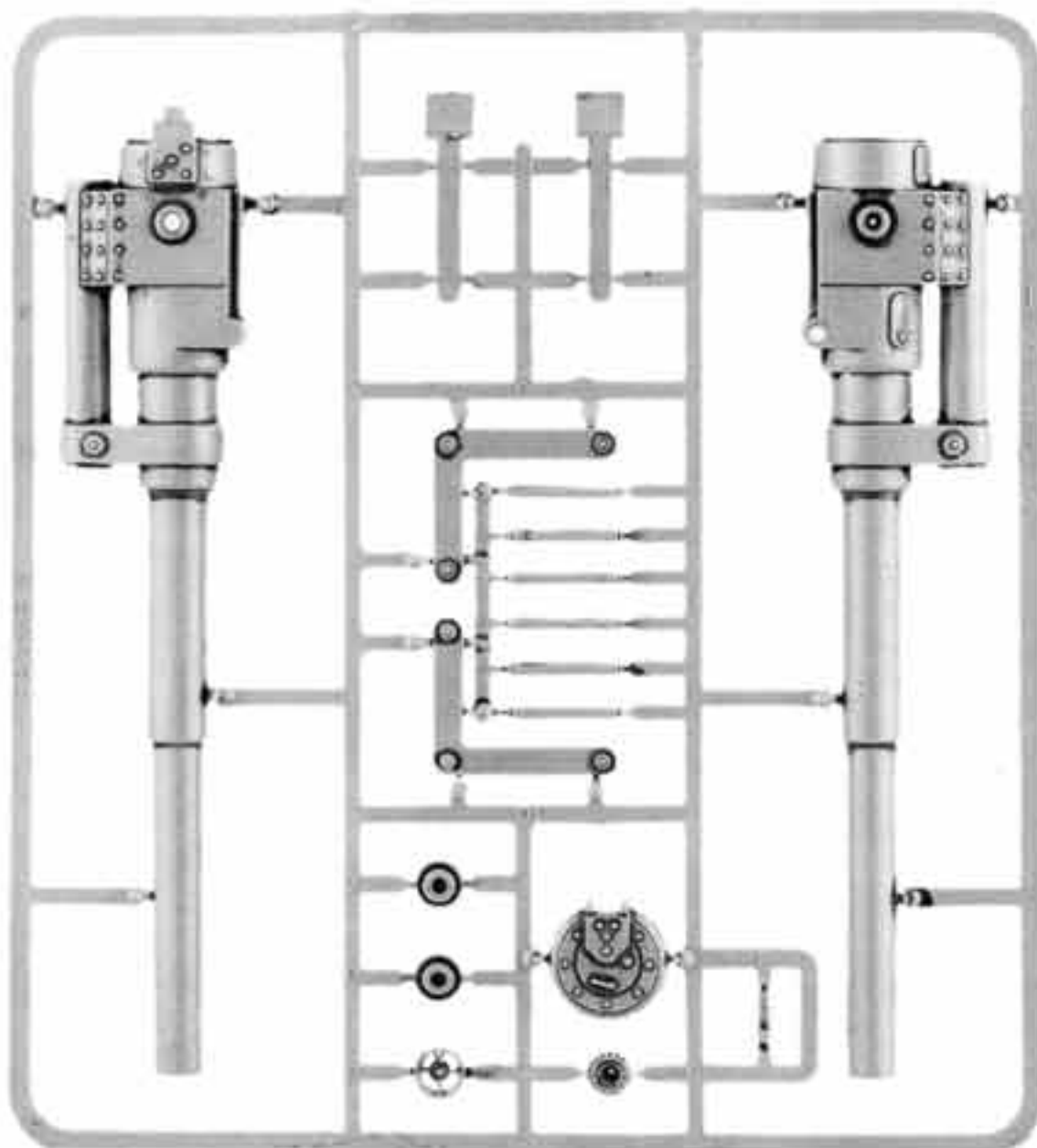

BASILISK FRAME E (SHOWN 60% ACTUAL SIZE)
99399999045

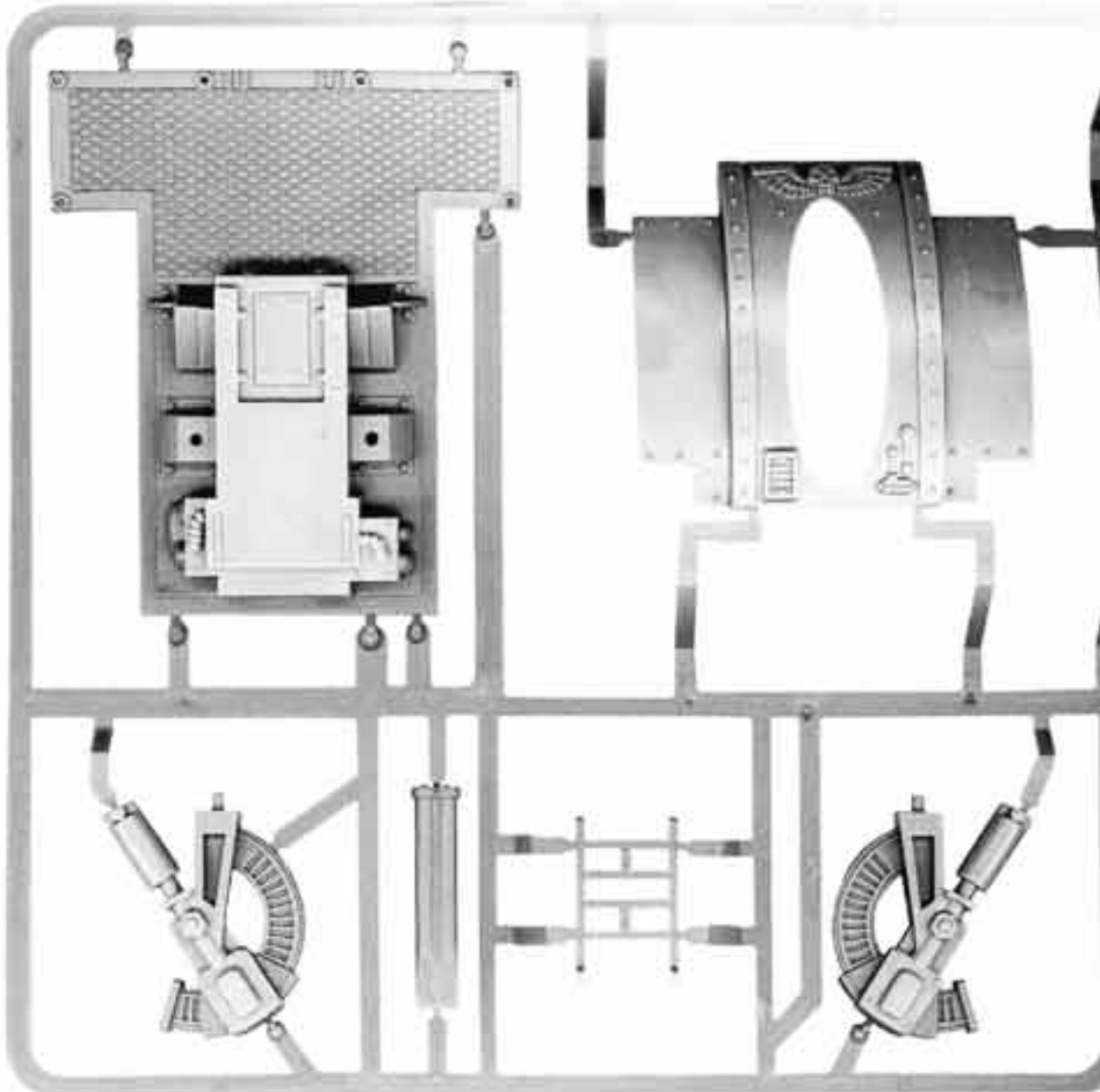

BASILISK FRAME D (SHOWN 60% ACTUAL SIZE)
99399999044



HEAVY SUPPORT

The Leman Russ Battle Tank boxed set includes the Imperial Tank Accessory Sprue (99390105003), Imperial Tank Track and Wheels Sprues (99399999042-3), and Imperial Guard Decal Sheet (99510105004) shown with the Chimera.



Leman Russ Battle Tank Box (1)
99120105011

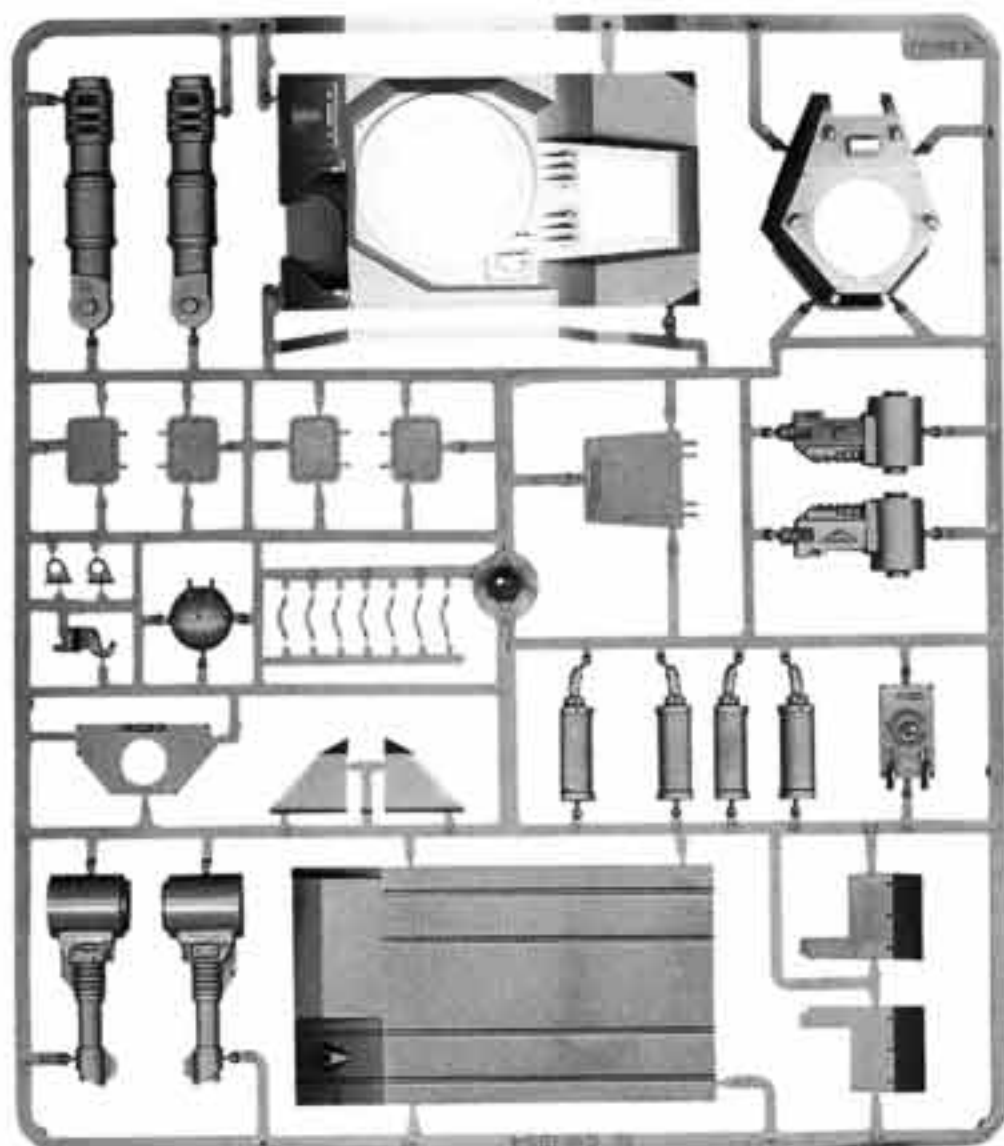

LEMAN RUSS HULL B (SHOWN 40% ACTUAL SIZE)
99399999053

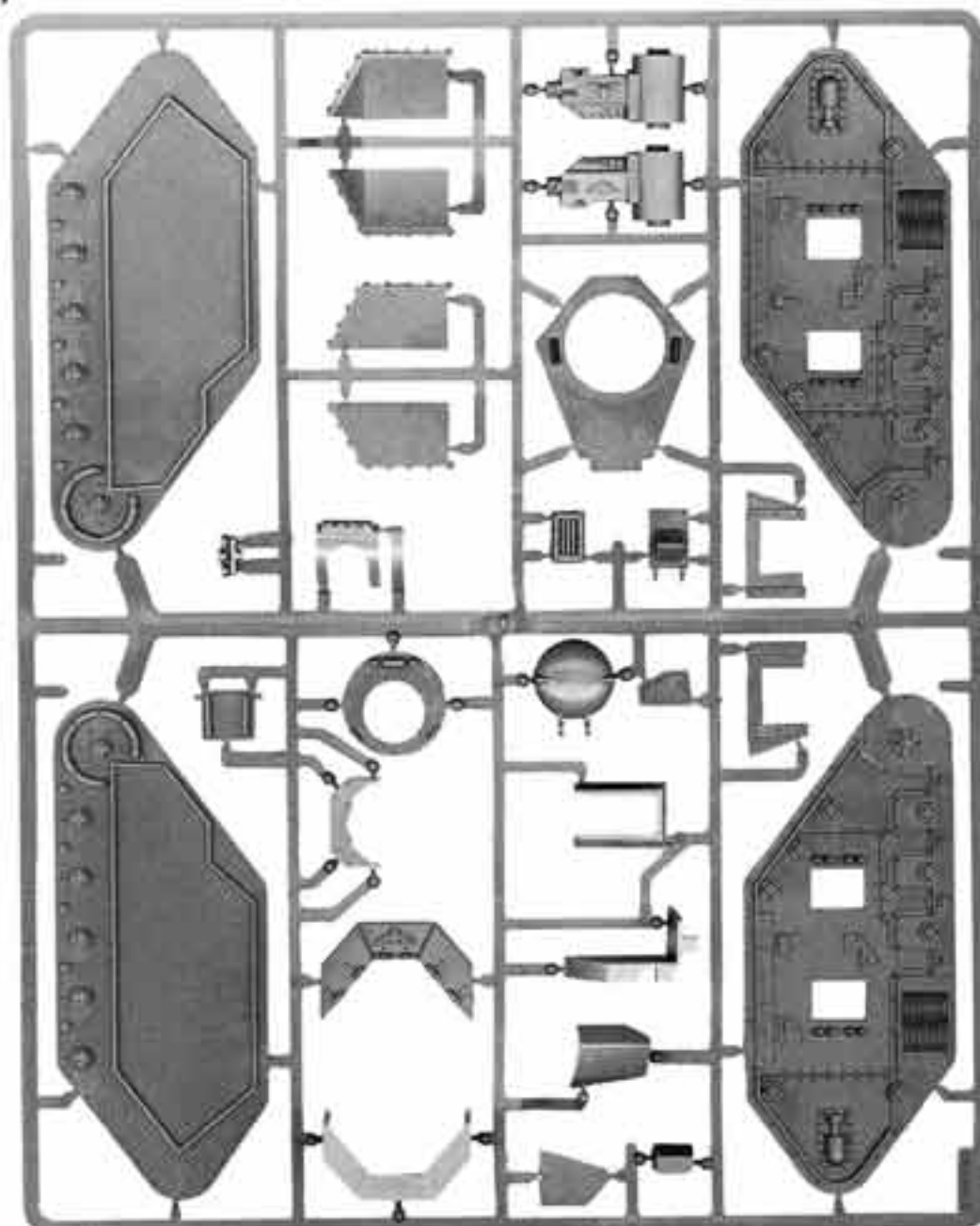

LEMAN RUSS HULL C (SHOWN 40% ACTUAL SIZE)
99399999052



HEAVY SUPPORT

TANK CAMOUFLAGE

Depending on what world and in what terrain you are fighting, camouflage can take on a variety of appearances.

PRAIRIE: Snakebite Leather, Bubonic Brown, and Bleached Bone



SWAMP: Chaos Black, Catachan Green, and Kommando Khaki



DESERT: Bubonic Brown, Graveyard Earth, and Bleached Bone



LAVA: Chaos Black, Bestial Brown, and Scab Red



JUNGLE: Dark Angels Green, Catachan Green, and Camo Green



SNOW: Catachan Green, Skull White, and Codex Grey



The Lemman Russ Demolisher Tank boxed set includes Lemman Russ Frame B and C (9939999052-3) shown with the Lemman Russ, the Imperial Tank Accessory Sprue (99390105003), Imperial Tank Track and Wheels Sprues (99399999042-3), and Imperial Guard Decal Sheet (99510105004) shown with the Chimera.



Leman Russ Demolisher shown smaller than actual size.



Leman Russ Demolisher Tank Box (1)
99140105167



DEMOLISHER CANNON
9947010516701



DEMOLISHER TURRET PLATE 1
9947010516704



DEMOLISHER TURRET PLATE 2
9947010516705



DEMOLISHER CANNON BARREL
9947010516702

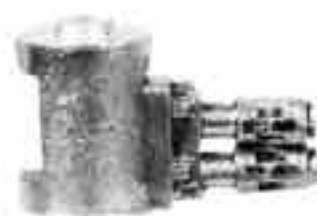

DEMOLISHER MULTI-MELTA SPONSON
9947010516708



DEMOLISHER PLASMA GUN SPONSON
9947010516707



DEMOLISHER CANNON MANTLET
9947010516703



DEMOLISHER ENGINE COVER
9947010516706

TACTICS

TIPS FOR WINNING WITH IMPERIAL GUARD



A. The Hellhound is a good match to the Chimera – both vehicles have comparable weaponry for the most part and both are good at anti-personnel firepower. The Hellhound's higher side armor can shield the Chimera's more vulnerable flanks.

B. A large mob of Conscripts can tie up enemy units in hand-to-hand combat for many turns, as long as you ensure that an officer is nearby to lend his Leadership (ideally, the company standard would be nearby as well in case you need a reroll!). Once the Conscript Squad has done its job and you are ready to open fire on the enemy warriors, you can revert to the Conscript's normal Leadership of 5 and they are very likely to run away and leave their opponents exposed to your guns.

C. If you are using Doctrines for your Imperial Guard force, Close Order Drill and Iron Discipline are both very valuable choices. Close Order Drill increases a unit's Leadership and Initiative, both of which are very handy in close combat – at Initiative 4, a unit of 10 Guardsmen has a chance to fight back against even such formidable foes as Space Marines and Orks! Meanwhile, the Iron Discipline doctrine will let your forces regroup even if under 50%, meaning that your precious heavy weapons and special weapons troopers have a greater chance of participating in the battle even if they need to run away once in a while.

D. The Imperial Guard has an unusual structure for its troops known as the Infantry Platoon. A single Infantry platoon can contain up to six heavy weapons and even more special weapons. Although not cheap, each special and heavy weapon is surrounded by plenty of grunts, meaning that your opponent has to chew through quite a few of your men to silence your best guns. A canny Imperial Guard player often fields as many heavy and special weapons as he can in order to maximize his firepower while leaving his opponent with several difficult choices – no matter which unit the enemy targets, there are still plenty more where that one came from. Manpower and firepower are the bywords of Imperial Guard might!

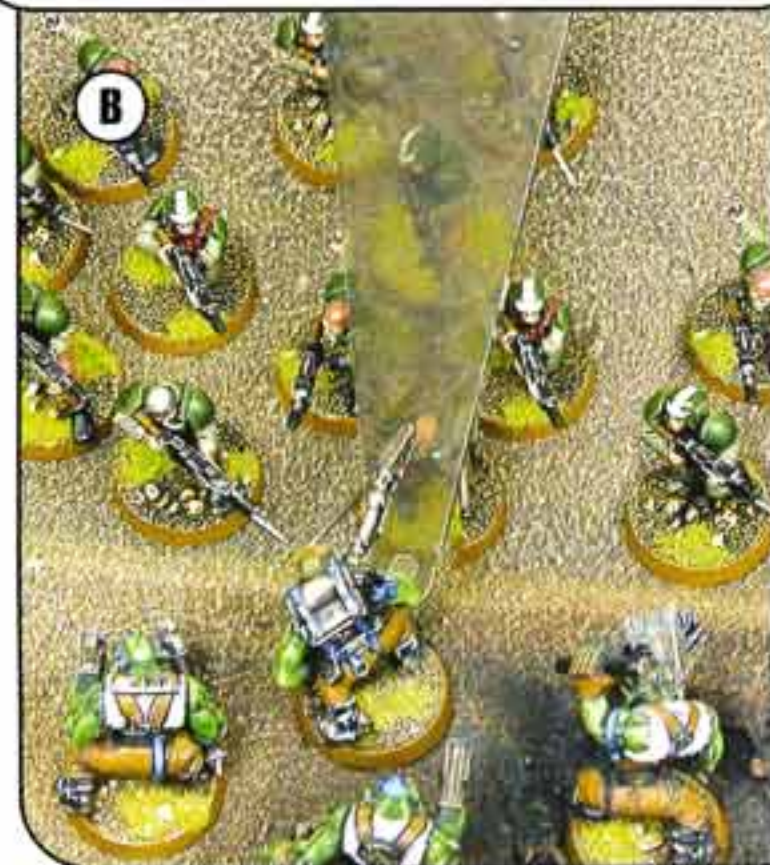
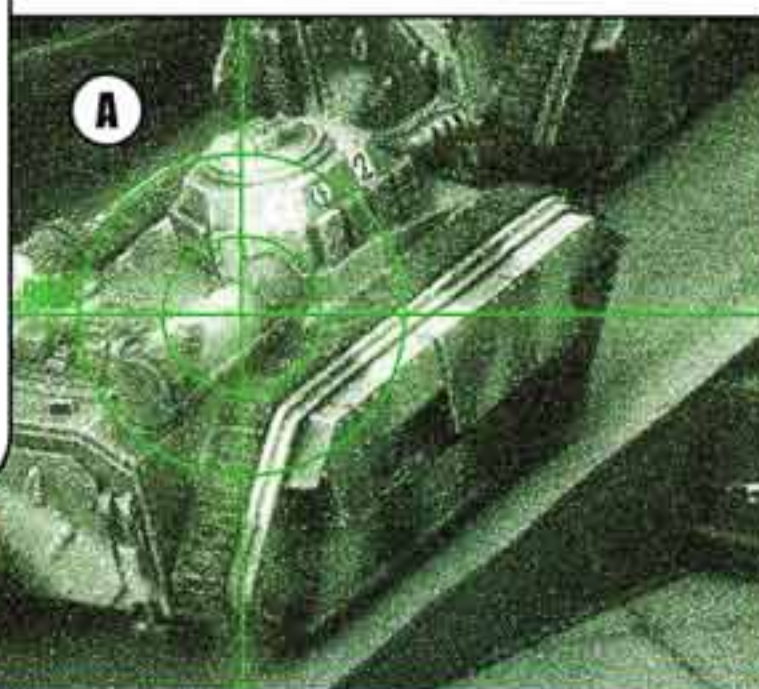

COUNTERTACTICS

TIPS FOR FIGHTING AGAINST IMPERIAL GUARD

A. Hellhounds are still only AV12 on the front and sides, not especially difficult to crack with lascannons or hunter-killer missiles. Also, you should keep in mind that immobilizing the Hellhound is nearly as good as blowing it up, as the Inferno cannon has a relatively short range of 24".

B. Any large infantry unit can be dealt with by template weapons, ordnance, or massed volleys of firepower. Conscripts can be tough to dislodge when they are in cover, but any reasonable amount of anti-personnel firepower (you should not waste lascannons shots on these 4-point soldiers!) will cut down their numbers to manageable levels, cause them to flee, or wipe them out.

C. Close Order Drill means that the Guardsmen have to be base-to-base in order to receive the doctrine's benefits. What this means for you is that the Guardsmen are in perfect flamer and ordnance formation! Any template weapon will reap massive benefits from firing at Close Order Drill troops, so feel free to cut loose with frag missiles and flamers when faced with these ordered firing lines.

D. One of the best ways to eliminate the manpower advantage of the Imperial Guard is to cut down on their Leadership. If you can eliminate the officers, the rank and file troopers won't last long in close combat or against massive casualties. An especially nasty trick is to use a unit that effects leadership in a wide radius, such as Necron Pariahs, and wade right into the middle of the Imperial Guard lines. Soon enough, you should see the Guardsmen (and their many, many heavy weapons) fleeing away from you!



COLORS OF WAR

KEY

■ Top Box(es): Basecoat Colors & Ink Washes

■ Bottom Box(es): Highlights

■ Mixed Colors



*Scorched Brown, Dark Angles Green
Desert Yellow, Camo Green*



*Chaos Black, Kommando Khaki
Kommando Khaki & Skull White*



*Graveyard Earth, Camo Green
Camo Green & Skull White*



*Chaos Black, Codex Grey
Codex Grey, Fortress Grey*



*Chaos Black, Snot Green
Dark Angles Green, Goblin Green*



*Chaos Black, Red Gore
Red Gore & Blood Red*



*Scorched Brown, Catachan Green
Bestial Brown, Goblin Green*



*Regal Blue, Enchanted Blue
Shadow Grey & Skull White*



*Chaos Black, Codex Grey
Fortress Grey, Bubonic Brown*



*Chaos Black, Codex Grey
Shadow Grey, Space Wolves Grey*



*Scorched Brown, Catachan Green
Bestial Brown, Bleached Bone*



*Shadow Grey, Codex Grey
Codex Grey, Skull White*



*Bestial Brown, Snot Green
Kommando Khaki, Golden Yellow*



*Scorched Brown, Kommando Khaki
Bestial Brown, Snakebite Leather*



*Fortress Grey, Shadow Grey
Codex Grey, Space Wolves Grey*



*Chaos Black, Shadow Grey
Fortress Grey, Skull White*



*Dark Angles Green, Snakebite Leather
Bubonic Brown & Bleached Bone*



*Scorched Brown, Kommando Khaki
Terracotta, Rotting Flesh*



*Snot Green, Bubonic Brown
Scorpion Green, Scorched Brown*



*Scorched Brown, Bestial Brown
Snakebite Leather, Kommando Khaki*

KEY

■ Top Box(es): Basecoat Colors & Ink Washes ■ Bottom Box(es): Highlights ■ Mixed Colors

COLORS OF WAR



IMPERIAL COMMISSAR
Chaos Black, Red Gore
Fortress Grey, Blood Red



CATACHAN
Dark Angles Green, Dwarf Flesh
Goblin Green, Dwarf Flesh & Skull White



CATACHAN
Dark Angles Green, Goblin Green
Snot Green, Scorpion Green



STEEL LEGION
Bubonic Brown, Scorched Brown
Bleached Bone, Snakebite Leather



TANITH GHOST
Codex Grey, Scorpion Green & Skull White
Fortress Grey, Goblin Green



CADIAN
Graveyard Earth, Catachan Green
Desert Yellow, Camo Green



CADIAN
Bestial Brown, Dark Angles Green
Bubonic Brown, Goblin Green



KASRKIN
Snot Green, Blood Red
Camo Green, Bleached Bone



CHIMERA TANK
Chaos Black, Fortress Grey
Bubonic Brown, Bleached Bone



ROUGH RIDER
Ultramarines Blue, Red Gore
Ice Blue, Blood Red



SHOWCASE

Left: Nathan Comanse's Cadian Leman Russ won first place at the 2004 Chicago Games Day Golden Demon Painting Competition in the 40K Vehicle or Squad category.



Above: Steve Buddle's Imperial Guard Commissar won third place at the 2003 UK Games Day Golden Demon Painting Contest in the 40K Single Miniature category.



Above: David Dresch's Steel Legion Hydra flak tank was a runner-up at the 2004 Chicago Games Day Golden Demon Painting Competition.

All miniatures are supplied unpainted. Models, bits, and sprues are all shown around size unless otherwise noted. Contents may vary from those shown.

SHOWCASE



Above: Mark Benedict's Imperial Guard Commissar from the 2004 Chicago Games Day Golden Demon Painting Competition.



ALTERNATE MODEL – ELITE
Ogryn
COMPONENTS FOR 2 COMPLETE MODELS

99380213005	Ogre Bull Sprue
9947010207407	Havoc Autocannon
9947099905505	B. Bowl Ogre Legs A
9947099905504	B. Bowl Ogre Shoulder Pads

COMPLEXITY RATING

● ● ● ○ ○ ○

ALTERNATE MODEL – TROOPS
Feral Guardsmen
COMPONENTS FOR 6 COMPLETE MODELS

99380105001	Catachan Sprue
99380201010	Chaos Marauders Sprue A
99380201011	Chaos Marauders Sprue B

COMPLEXITY RATING

● ● ● ○ ○ ○



ALTERNATE MODEL – TROOPS
Imperial Conscripts
COMPONENTS FOR 7 COMPLETE MODELS

99380105002	Cadian Sprue
99381102001	Empire Militia Sprue

COMPLEXITY RATING

● ○ ○ ○ ○ ○



All miniatures are supplied unpainted. Models, bits, and sprues are all shown at their actual size unless otherwise stated. Contents may vary slightly from those shown.



THE INQUISITION

We are at war with forces too terrible to comprehend. We cannot afford mercy for any of its victims too weak to take the correct course. Mercy destroys us; it weakens us and saps our resolve. Put aside all such thoughts. They are not worthy of Inquisitors in the service of Our Emperor. Praise his name, for in our resolve we only reflect his purpose of will.

– Inquisitor Enoch, Castigations of the Last Days

Waging a covert war for over 10,000 years, the vast Imperial institution known as the Inquisition has thousands of divisions and subdivisions. Some of them take to the field of battle when forces threaten the continued survival of the Imperium of Man. Noteworthy among them are the Ordo Malleus, or Daemonhunters, and the Ordo Hereticus, or Witch Hunters.

The Inquisitors of the Ordo Malleus work to destroy the physical manifestation of Chaos itself: the Daemon. An Inquisitor has at his disposal every member of the Imperium and will not hesitate to commandeer local troops at a moment's notice. Such is the influence of the Inquisitor that he can call upon the Space Marines of the Adeptus Astartes or even the feared Grey Knights and lead a force of the Imperium's finest warriors against Humanity's foul nemeses, wherever they appear.

While the Daemonhunters protect the Imperium from outside enemies, the Ordo Hereticus defends Humanity against threats from within: witchcraft, heresy, and mutation. The Witch Hunters keep a close watch on many other Imperial organizations, from the

Adeptus Arbites, to the Astropaths, to the Inquisition itself. It is a brave man who crosses a Witch Hunter, as simply opposing a member of the Ordo Hereticus can bring accusations of heresy and witchcraft. The Chamber Militant of the Ordo Hereticus is the virtuous and pious Adepta Sororitas, the Sisters of Battle. This ancient order of warrior women is dedicated to the Emperor



This Sister of Battle Banner Bearer by Will Hahn was a Runner Up at the 2004 Los Angeles Games Day Golden Demon Painting Competition.

and the Imperial creed and includes the best and bravest warriors a Witch Hunter can call upon.

Fighting Style

The armies of the Ordo Hereticus and Ordo Malleus possess so much variety that they can bring to bear any number of different methods to gain victory. The Grey Knights of the Daemonhunters, while few in number, combine hard-hitting assault capability with an impressive amount of firepower. The Adepta Sororitas, by contrast, can field a massive force of fast-moving troops with devastating short-range firepower. Inquisitorial forces can also call upon Imperial Assassins and Death Cultists to add another type of hand-to-hand combat ability. No doubt, versatility is the greatest strength of the Inquisition, and there is no limit to the combinations of units you can use to smite the foes of the Emperor.

Collecting an Inquisition Army

At the core of the Daemonhunter army is a collection of elite and incredibly skilled individuals who excel in every battlefield role. Even the lowest ranks of the Grey Knights are the equal of the strongest units of other armies. Grey Knights are well equipped, which means that both their ranged and close combat capabilities far outstrip those of their brother Space Marines. A Daemonhunter army can also call on allies and inducted troops. From lethal Death Cultists, to mighty Dreadnoughts, to unpredictable Daemonhosts, the army list presents an entire spectrum of the Imperial war machine. If you're looking for an elite, diverse force, then a Daemonhunter force may be the army for you.

The armies of the Ordo Hereticus can call upon both the zealous forces of the Ecclesiarchy and the well-armed Adepta Sororitas, also known as the Sisters of Battle. The warrior women of the Sisters of Battle form the mainstay of the military forces of



Dave Pauwels' Death Cult Assassin won third place at the 2004 Atlanta Games Day Golden Demon Painting Competition.

the Ordo Hereticus. Battle Sisters armed with bolters, wearing power armor, and possessing frighteningly powerful faith can handle nearly any challenge. In addition, the Ordo Hereticus can call upon highly trained units of Inquisitorial Stormtroopers to lend aid with special equipment and armored personnel carriers. The Ordo Hereticus has other, even more dangerous assets. They include Arco-Flagellants, normal humans who have been transformed into cybernetic killing machines as punishment for past heresies; the Sisters Repentia, Battle Sisters who seek atonement by fighting with righteous and unbridled fury; and Celestian Squads, Battle Sisters who have proven themselves above and beyond the call of duty.

These diverse forces can be tailor made to fit almost any strategic and tactical style. Collecting a Daemonhunter or Witch Hunter force will be a rewarding experience for both the hobbyist and the gamer in you!



Tom Schadle's Inquisitor Acolyte won first place at the 2004 Baltimore Games Day Golden Demon painting competition.

GETTING STARTED

This Witch Hunter army incorporates a number of different elements from the Inquisition's arsenal: Grey Knights, Sisters of Battle, a Dreadnought, and an Inquisitor with his Henchmen.



**Codex:
Daemonhunters**
60030107001



**Codex:
Witch Hunters**
60030108005

Codex: Daemonhunters and Codex: Witch Hunters include all the rules and information you need to field a Daemonhunter or Witch Hunter army, respectively. Also included are painting guides, scenarios, background information, rules for Special Characters, and much more.

Both of these armies are highly adaptable, and both can be used as allies by Space Marine and Imperial Guard armies as well as by each other. Smite the unholy Daemon and the Heretic and defend the Imperium from foes within and without.

HQ



**Living Saint
Celestine Blister (1)**
99060108061



**ST. CELESTINE
BODY**
9947010806101



**ST. CELESTINE
CLOAK**
9947010806102



**ST. CELESTINE
HALO**
9947010806103



**ST. CELESTINE
SWORD**
9947010806104



**Grey Knight
Brother-Captain
Stern Blister (1)**
99060107014



CAPT. STERN SPRUE
9947010701401



**CAPT. STERN
ARM**
9947010701403



CAPT. STERN BODY
9947010701402



HQ



The *Daemonhunter Inquisitor & Retinue Box* contains the two *servo-skulls* shown to the right.



Daemonhunter Inquisitor & Retinue Box (7)
99110107001



DAEMONHUNTER ACOLYTE
9947010700104



ANOINTED DAEMONHAMMER
9947010700101



TORQUEMADA COTEAZ BODY
9947010700102



GLOVODAN EAGLE
9947010700103



DAEMONHUNTER SAGE 1
9947010700105



DAEMONHUNTER CHERUB 1
9947010700106



GUN SERVITOR BODY 1
9947010700107



GUN SERVITOR MULTI MELTA
9947010700108



SERVO-SKULL (RANDOM 1)
9947010700505



Witch Hunter Inquisitor & Retinue Box (7)
99110108045



WITCH HUNTER
INQUISITOR BODY
9947010804501



INQUISITOR
SWORD
9947010804502



WITCH HUNTER
ACOLYTE 1
9947010804506



WITCH HUNTER
CRUSADER 1
9947010804503



WITCH HUNTER
PENITENT WITCH
9947010804507



WITCH HUNTER
CHERUB 1
9947010804508



WITCH HUNTER
HOSPITALIER
9947010804504



WITCH HUNTER
LEXMECHANIC
9947010804505

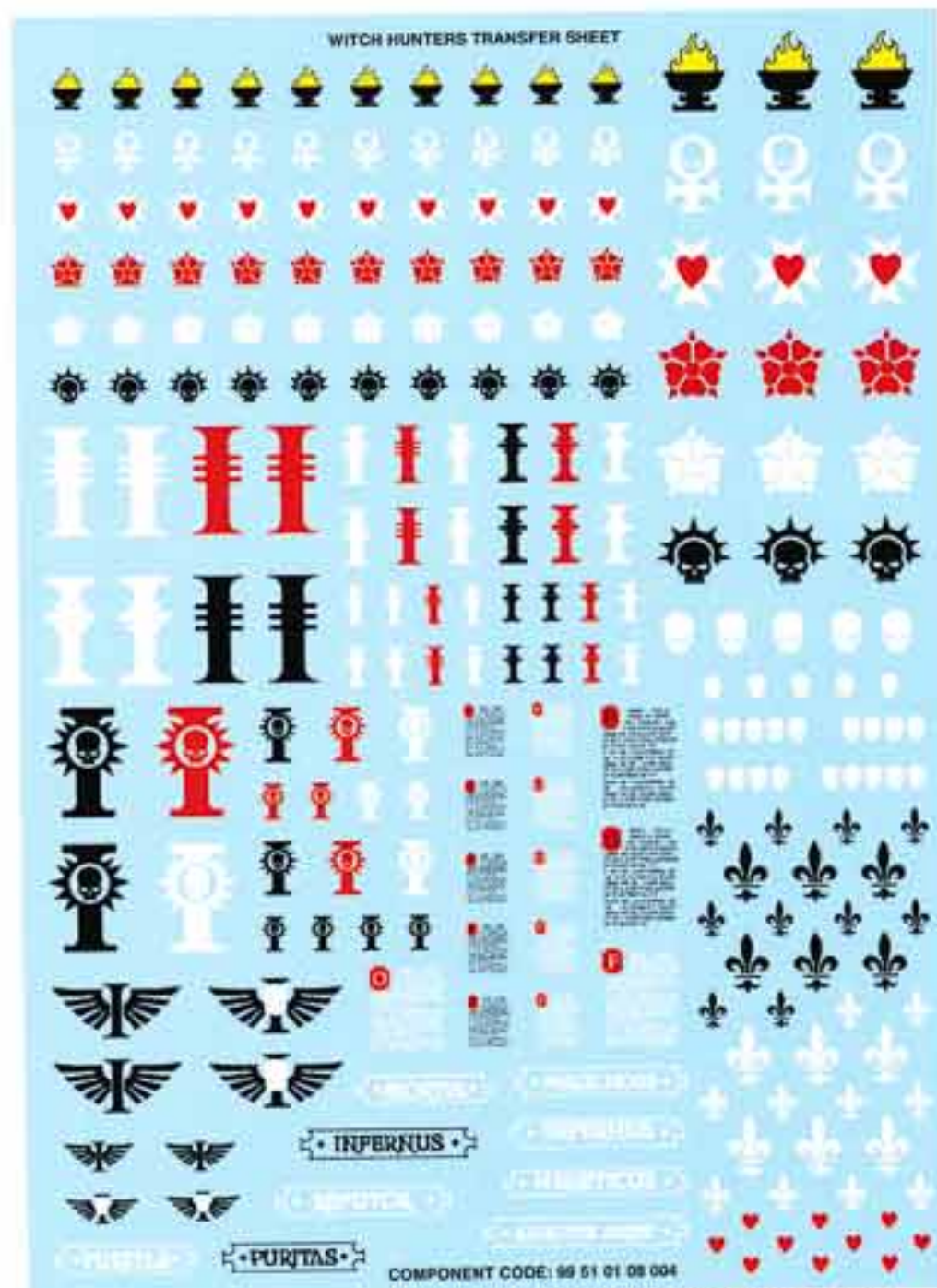

WITCH HUNTERS DECAL SHEET (SHOWN 85% ACTUAL SIZE)
99510108004



HQ



DAEMONHUNTER
BOOK
9947010701202



DAEMONHUNTER
GUN
9947010701204



Daemonhunter Inquisitor Blister (Random 1)
99060107012



DAEMONHUNTER
SWORD
9947010701206



DAEMONHUNTER
BODY 1
9947010701201



DAEMONHUNTER
BODY 2
9947010701203



DAEMONHUNTER
BODY 3
9947010701205



The Daemonhunter Henchmen are only available via Special Offer.



DAEMONHUNTER
MYSTIC
9947010700501



DAEMONHUNTER
HIEROPHANT
9947010700502



DAEMONHUNTER
SAGE 2
9947010700503

Daemonhunter Henchmen Blister (Random 5)
99060107005

The Daemonhunter Henchmen blister also contains two random Servo-Skulls (9947010700505) shown previously.



The Acolyte & Cherub are only available via Special Offer.



DAEMONHUNTER
CHERUB 2
9947010701801



DAEMONHUNTER
ACOLYTE
9947010700104

Acolyte & Cherub Blister (Random 3)
99060107018

The Acolyte & Cherub blister also contains one random Servo-Skull (9947010700505) shown previously.



WITCH HUNTER
INQUISITOR 1
9947010804901

WITCH HUNTER
INQUISITOR 2
9947010804902

WITCH HUNTER
INQUISITOR 3
9947010804903

Witch Hunter Inquisitor Blister (Random 1)
99060108049



MISSIONARY
PACK 1
9947010801203



MISSIONARY
PACK 2
9947010801205



MISSIONARY 1
CHAINSWORD
9947010801202



Imperial Missionary Blister (Random 1)
99060108012



MISSIONARY BODY 1
9947010801201



MISSIONARY BODY 2
9947010801204

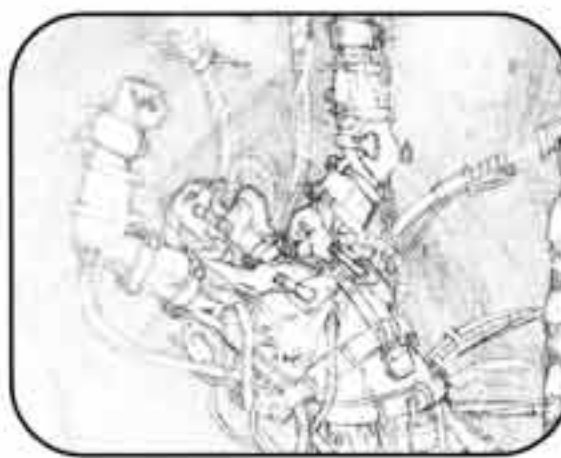

WITCH HUNTER
CRUSADER 2
9947010804801

WITCH HUNTER
DIALOGOUS
9947010804802

WITCH HUNTER
ACOLYTE 2
9947010804803

WITCH HUNTER
SERVO-SKULL 1
9947010804804

WITCH HUNTER
CHERUB 2
9947010804805

WITCH HUNTER
SERVO-SKULL 2
9947010804806

Witch Hunter Henchmen Blister (Random 1 Henchman and Random 1 Servo-Skull or Cherub)
99060108048



HQ



COMBAT SERVITOR 1
9947010701702

COMBAT SERVITOR 2
9947010701703

Imperial Servitor Blister (Random 2)
99060107017



GUN SERVITOR BODY 1
9947010700107



GUN SERVITOR BODY 2
9947010701701

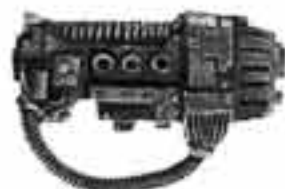

GUN SERVITOR
PLASMA CANNON
9947010701705



GUN SERVITOR
HEAVY BOLTER
9947010701704



GUN SERVITOR
MULTI MELTA
9947010700108



IMPERIAL PREACHER 1
9947010802201



IMPERIAL PREACHER 2
9947010802202



IMPERIAL PREACHER 3
9947010802203

Imperial Preacher Blister (Random 1)
99060108022



Sisters of Battle Canoness Blister (Random 1)
99060108056



CANONESS
BODY
9947010805601



CANONESS
SWORD SPRUE
9947010805602



CANONESS
PISTOL SPRUE
9947010805603



CANONESS
BOOK SPRUE
9947010805604



CANONESS
BACKPACK 1
9947010805605



CANONESS
BACKPACK 2
9947010805606



THRONE OF JUDGEMENT FRONT
9947010805101



THRONE OF JUDGEMENT LEFT TANK
9947010805105



THRONE OF JUDGEMENT RIGHT TANK
9947010805106



THRONE OF JUDGEMENT SEAT
9947010805102



THRONE OF JUDGEMENT SPRUE 1
9947010805107



THRONE OF JUDGEMENT TORSO
9947010805108



THRONE OF JUDGEMENT ENGINE
9947010805103



THRONE OF JUDGEMENT RIGHT LEG
9947010805109



THRONE OF JUDGEMENT LEFT LEG
9947010805110



THRONE OF JUDGEMENT BANNERS
9947010805104



THRONE OF JUDGEMENT SPRUE 2
9947010805111



THRONE OF JUDGEMENT FEET
9947010805112



Throne of Judgement Box (1)
99110108051

The Throne of Judgement also includes Witch Hunters Decal Sheet (99510108004) shown earlier.



THRONE OF JUDGEMENT MELTA
9947010805113



INQUISITOR TORSO
9947010805114



INQUISITOR LEGS
9947010805115



INQUISITOR ARM SPRUE
9947010805116



THRONE SERVITOR 1
9947010805117



THRONE SERVITOR 2
9947010805118



ELITES



**ARCO-FLAGELLANT
BODY 1**
99947010805801



**ARCO-FLAGELLANT
BODY 2**
99947010805803



**ARCO-FLAGELLANT
ARM SPRUE 1**
99947010805802



**ARCO-FLAGELLANT
ARM SPRUE 2**
99947010805804

Arco-Flagellants Box (6)
99110108058



DAEMONHOST 1
9947010700401

DAEMONHOST 2
9947010700402

Daemonhost Blister (Random 1)
99060107004



Sisters Repentia Box (10)
99110108055



SISTER REPENTIA 1
9947010805503

SISTER REPENTIA 2
9947010805504

SISTER REPENTIA 3
9947010805505

SISTER REPENTIA 4
9947010805506

Sisters Repentia Blister (Random 3)
99060108059



**REPENTIA
MISTRESS BODY**
9947010805501



**REPENTIA
MISTRESS ARM**
9947010805502

ELITES



Grey Knight Terminators Box (5)
99110107006



Grey Knight Terminator Blister (Random 1)
99060107013



GREY KNIGHT CAPTAIN BODY
9947010700602



GREY KNIGHT TERMINATOR 1
9947010700604



GREY KNIGHT TERMINATOR 2
9947010700605



GREY KNIGHT TERMINATOR 3
9947010700606



Grey Knight Terminator w/ Incinerator Blister (Random 1)
99060107015



GREY KNIGHT CAPTAIN ARM
9947010700603



GREY KNIGHT STORM BOLTER 1
9947010700607



GREY KNIGHT STORM BOLTER 2
9947010700608



GREY KNIGHT INCINERATOR
9947010700609



GREY KNIGHT PSYCANNON
9947010700610



GREY KNIGHT SHIELD SPRUE
9947010700615



GREY KNIGHT CAPTAIN FORCE HALBERD
9947010700601



GREY KNIGHT FORCE SWORD 1
9947010700611



GREY KNIGHT FORCE SWORD 2
9947010700612



GREY KNIGHT FORCE HALBERD 1
9947010700613



GREY KNIGHT FORCE HALBERD 2
9947010700614



Grey Knight Terminator w/ Psycannon Blister (Random 1)
99060107008



ELITES



DEATH CULT
ASSASSIN 1
9947010700701

DEATH CULT
ASSASSIN 2
9947010700702

Death Cult Assassins Blister (2)
99060107007



CALLIDUS ASSASSIN 2
9947010800203



CALLIDUS ASSASSIN 1

Callidus Assassin Blister (Random 1)
99060108002



CALLIDUS BODY
9947010800201



CALLIDUS LEGS
9947010800202



Vindicare Assassin Blister (Random 1)
99060108001



VINDICARE BODY 1
9947010800101



VINDICARE BODY 2
9947010800103



VINDICARE EXITUS RIFLE 1
9947010800102



VINDICARE EXITUS RIFLE 2
9947010800104



Eversor Assassin Blister (Random 1)
99060108003



EVERSOR BODY1
9947010800301



EVERSOR BODY 2
9947010800304



EVERSOR ARM 1
9947010800302



EVERSOR ARM 2
9947010800305



EVERSOR PACK 1
9947010800303



EVERSOR PACK 2
9947010800306



Culexus Assassin Blister (Random 1)
99060108026



CULEXUS BODY
9947010802601



CULEXUS HEAD 1
9947010802603



CULEXUS HEAD 2
9947010802604



CULEXUS EYE
9947010802602

TROOPS

ADDING INQUISITORIAL FLAIR TO YOUR VEHICLES

While the stock Rhinos and Chimeras available are perfectly fine for inclusion in your Inquisition forces, a few Inquisitorial details here and there can't go too far wrong.

The accessory sprues from various characters in the Inquisitor range are great for little icons and details to add to your vehicles.

Inquisitors Covenant and Eisenhorn come with sprues that include a number of appropriate symbols, and vehicle-sized purity seals can also be made out of putty and thin plasticard.



Shown below is a template that you can use to make an icon for your Inquisitorial Chimeras. Simply copy the template, transfer the shapes to plasticard or cardboard, and cut them out.



CHIMERA ICON TEMPLATE

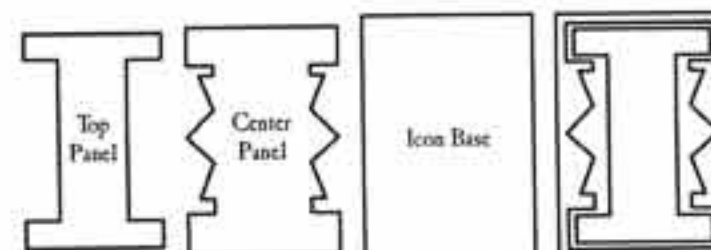

Copy Templates at 135%



All of the Stormtrooper Blisters and Bitz are only available via Special Offer.



STORMTROOPER SERGEANT 1
9947010513601

STORMTROOPER SERGEANT 2
9947010513602

Stormtrooper Sergeant Blister (Random 1)
99060105183



STORMTROOPER 1
9947010513701

STORMTROOPER 2
9947010513702

STORMTROOPER 3
9947010513703

STORMTROOPER 4
9947010513704

Stormtroopers Blister (Random 3)
99060105137



STORMTROOPER W/ MELTAGUN
9947010514101

STORMTROOPER W/ PLASMA GUN
9947010514102

STORMTROOPER W/ FLAMER
9947010514103

STORMTROOPER W/ GRENADE LAUNCHER
9947010514104

Stormtroopers w/ Assault Weapons Blister (Random 2)
99060105182





TROOPS



Sisters of Battle Squad Box (10)
99110108062



SISTER OF BATTLE IMAGIFER 1
9947010805001

SISTER OF BATTLE IMAGIFER 2
9947010805002

Sisters of Battle Imagifer Blister (Random 1)
99060108050



SISTER SUPERIOR W/ PLASMA PISTOL
9947010805201

SISTER SUPERIOR W/ BOLT PISTOL
9947010805202

Sisters of Battle Sister Superior Blister (Random 1)
99060108052



BATTLE SISTER W/ FLAMER
9947010805701

BATTLE SISTER W/ STORM BOLTER 1
9947010805702



BATTLE SISTER W/ STORM BOLTER 2
9947010805703

BATTLE SISTER W/ MELTA 2
9947010805704

Sisters of Battle w/ Assault Weapons Blister (Random 2)
99060108057



SISTER OF BATTLE 1
9947010800403

SISTER OF BATTLE 2
9947010800404

SISTER OF BATTLE 3
9947010800405



SISTER OF BATTLE 4
9947010800407

SISTER OF BATTLE 5
9947010801308

SISTER OF BATTLE 6
9947010801309

SISTER OF BATTLE 7
9947010801310

Sisters of Battle Blister (Random 3)
99060108013



SISTERS OF BATTLE PACK
9947010800401

All Sisters of Battle blisters contain one Sisters of Battle Pack (9947010800401) for each model.

TROOPS



Grey Knight Squad Box (5)
99110107002

Grey Knight Blister (Random 2)
99060107011



**Grey Knight w/
Incinerator Blister (1)**
99060107010
BIT NAME: GREY KNIGHT
W/ INCINERATOR
BIT CODE: 9947010700211



GREY KNIGHT SWORD
9947010700206



**Grey Knight w/
Psycannon Blister (1)**
99060107016
BIT NAME: GREY KNIGHT
W/ PSYCANNON
BIT CODE: 9947010701601



Grey Knight Justicar Blister (1)
99060107009



**GREY KNIGHT
BODY 3**
9947010700204



**GREY KNIGHT
BODY 4**
9947010700205



GREY KNIGHT HALBERD 1
9947010700207



**GREY KNIGHT
JUSTICAR BODY**
9947010700201



**GREY KNIGHT
BODY 1**
9947010700202



**GREY KNIGHT
BODY 2**
9947010700203



GREY KNIGHT HALBERD 2
9947010700208



GREY KNIGHT HALBERD 3
9947010700209



SPACE MARINE BACKPACK SPRUE
99380101004



GREY KNIGHT HALBERD 4
9947010700210



FAST ATTACK

HEAD SWAPS

One of the biggest complaints among Sisters of Battle players is that as the majority of the range is made of metal figurines; thus, larger armies tend to be a bit repetitive, because the same model must be used over and over. One of the best ways to change the look of a figure is to replace the head.

While doing a head swap on most miniatures is rather easy, the design of the Sisters' armor makes this conversion a bit difficult to accomplish. Use a saw and cut across the top of the armored collar. This step serves two purposes. First, of course, you get rid of the old head. Secondly, it is much easier (and safer) to drill on a flat surface rather than a curved or irregular surface.



Now that you have a flat area, drill a hole in the center of the stump. Start with your smallest bit and gradually progress through the sizes until you make a large enough hole. To enlarge the hole you may need to use a routing bit in a motorized rotary tool. If you don't have one, you can also carefully carving out the excess with a hobby knife. While it might seem tempting to begin with the largest bit, it is better to progress through the sizes gradually. With a rotary tool, it is safer to progress from smaller to larger bits, and doing so also gives you more control on the location, angle, and depth of your hole.



You may need to clean up the area with a needle file to make everything neat and smooth. Amazon heads from the Mordheim range make perfect Sisters of Battle heads. Cut off the topknot. To hide the spot where the topknot was removed, use green stuff and sculpt some extra hair. Some Elven heads from the Warhammer range work well as Sisters of Battle heads too.



Sisters of Battle Seraphim Squad Box (5)
99110108063

The Seraphim Squad includes a Witch Hunters Decal Sheet (99510108004) shown in the HQ section.



SERAPHIM JUMP PACK
9947010801001

Seraphim boxes and blisters include one Seraphim Jump Pack (9947010801001) for each model.



SERAPHIM SUPERIOR W/ POWER SWORD
9947010804601

SERAPHIM SUPERIOR W/ PLASMA PISTOL
9947010804602

SERAPHIM SUPERIOR W/ BOLT PISTOL
9947010804603

Sisters of Battle Seraphim Superior Blister (Random 1)
99060108046



SERAPHIM W/ BOLT PISTOLS 1
9947010801002

SERAPHIM W/ BOLT PISTOLS 2
9947010801004

SERAPHIM W/ HAND FLAMERS
9947010801005

Sisters of Battle Seraphim Blister (Random 1)
99060108039

Sisters of Battle Seraphim w/ Hand Flamers Blister (2)
99060108043

All miniatures are supplied unpainted. Models, bits, and sprues are all shown at actual size unless otherwise noted. Contents may vary slightly from those shown.



HEAVY SUPPORT



The Penitent Engine boxed set includes the Witch Hunters Decal Sheet (99510108004) shown in the HQ section.

Penitent Engine Box (1)
99110108053



PENITENT ENGINE DRIVER 1
9947010805301



PENITENT ENGINE DRIVER 2
9947010805302



PENITENT ENGINE BACK
9947010805303



PENITENT ENGINE BODY
9947010805304



PENITENT ENGINE ARM PLATE
9947010805305



PENITENT ENGINE LOWER BODY
9947010805306



PENITENT ENGINE EXHAUST
9947010805308



PENITENT ENGINE RIGHT ARM
9947010805309



PENITENT ENGINE LEFT ARM
9947010805311



PENITENT ENGINE FOOT
9947010805307



PENITENT ENGINE LEFT LEG
9947010805310



PENITENT ENGINE RIGHT ARM
9947010805312





HEAVY SUPPORT

The Immolator boxed set includes the Witch Hunter Decal Sheet (99510108004) shown in the HQ section.



MAKING FIRE

As part of the holy trinity of Bolter, Flamer, and Melta, you might find yourself wanting to represent the fiery wrath of the Emperor! To make your flames, start with an armature to build around. The armature will help your flames maintain their shape as they cure and will help you to shape them while the green stuff is still soft. The easiest way to make an armature is to use a small bit of wire or paperclip. Use pliers to shape the wire into approximate a flame shape and then glue the armature into the barrel of the weapon.

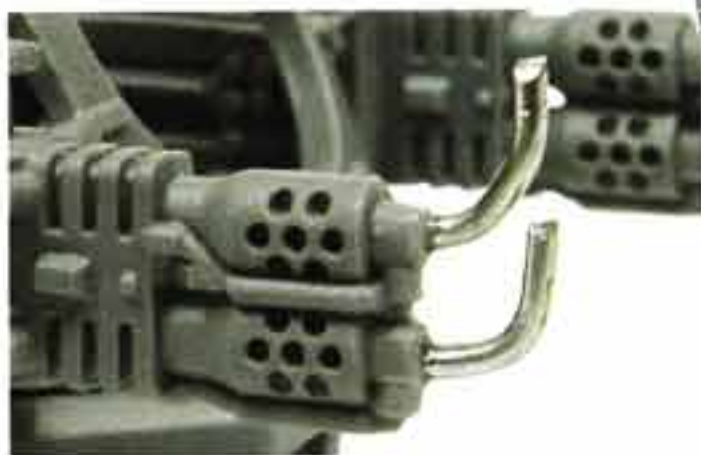

Once the glue on the armature is set, use a teardrop-shaped blob of green stuff to make the general shape of the flames.

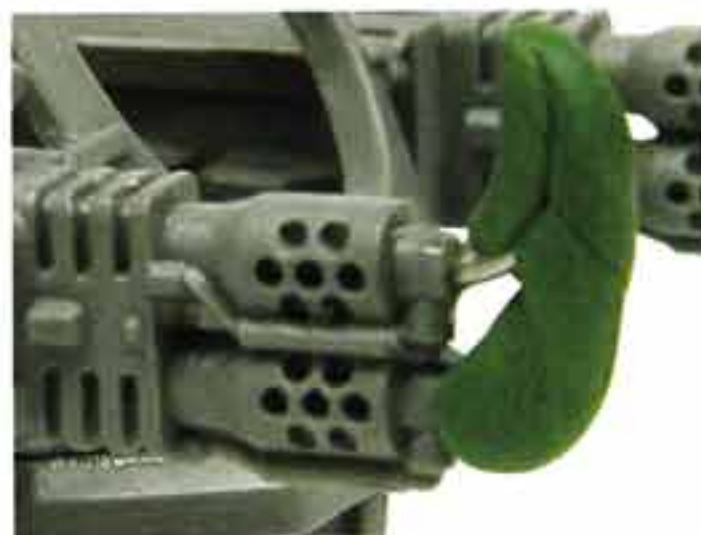

To give it that blazin' look, make a series of parallel, wavy lines to create individual tongues of flame. If you start at the bottom and work your way to the top, you can make very convincing flame effects!

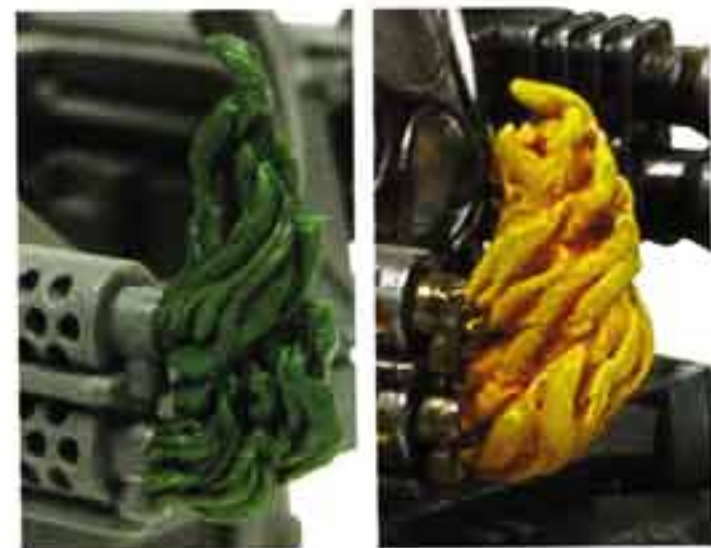

Sisters of Battle Immolator Box (1)
99120108001

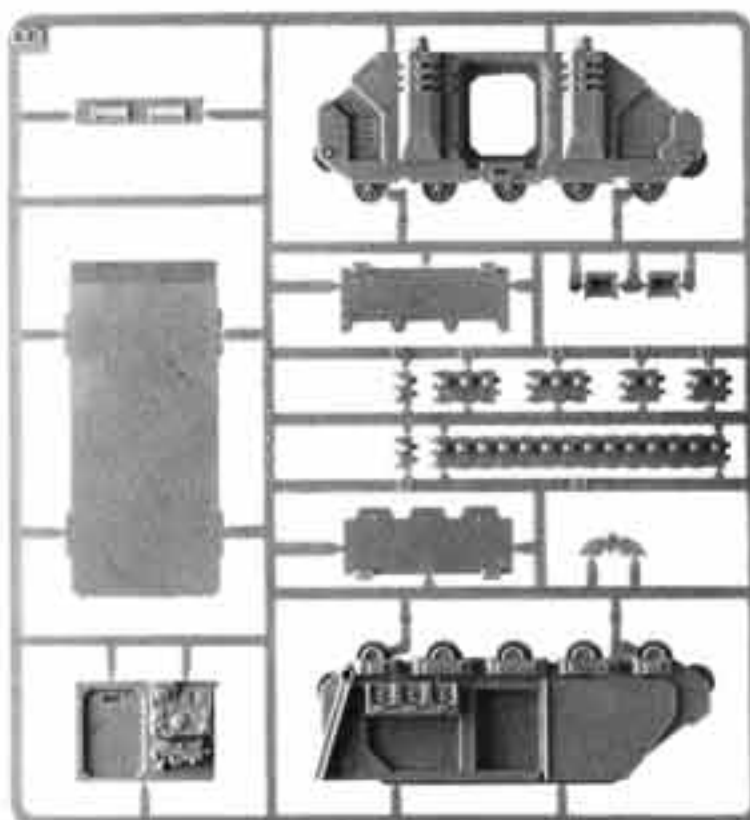

RHINO SPRUE 1 (SHOWN 30% ACTUAL SIZE)
99390199004

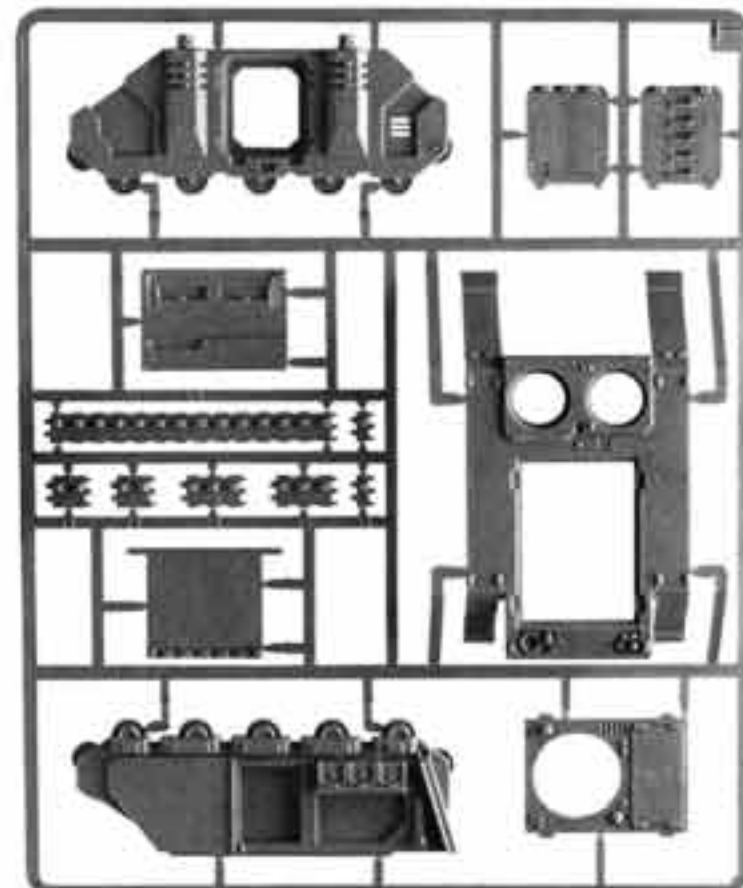

RHINO SPRUE 2 (SHOWN 30% ACTUAL SIZE)
99390199005

Larger pictures of the Rhino sprues can be found in the Space Marine section.



SISTERS OF BATTLE CANOPY
99390108002



HEAVY SUPPORT

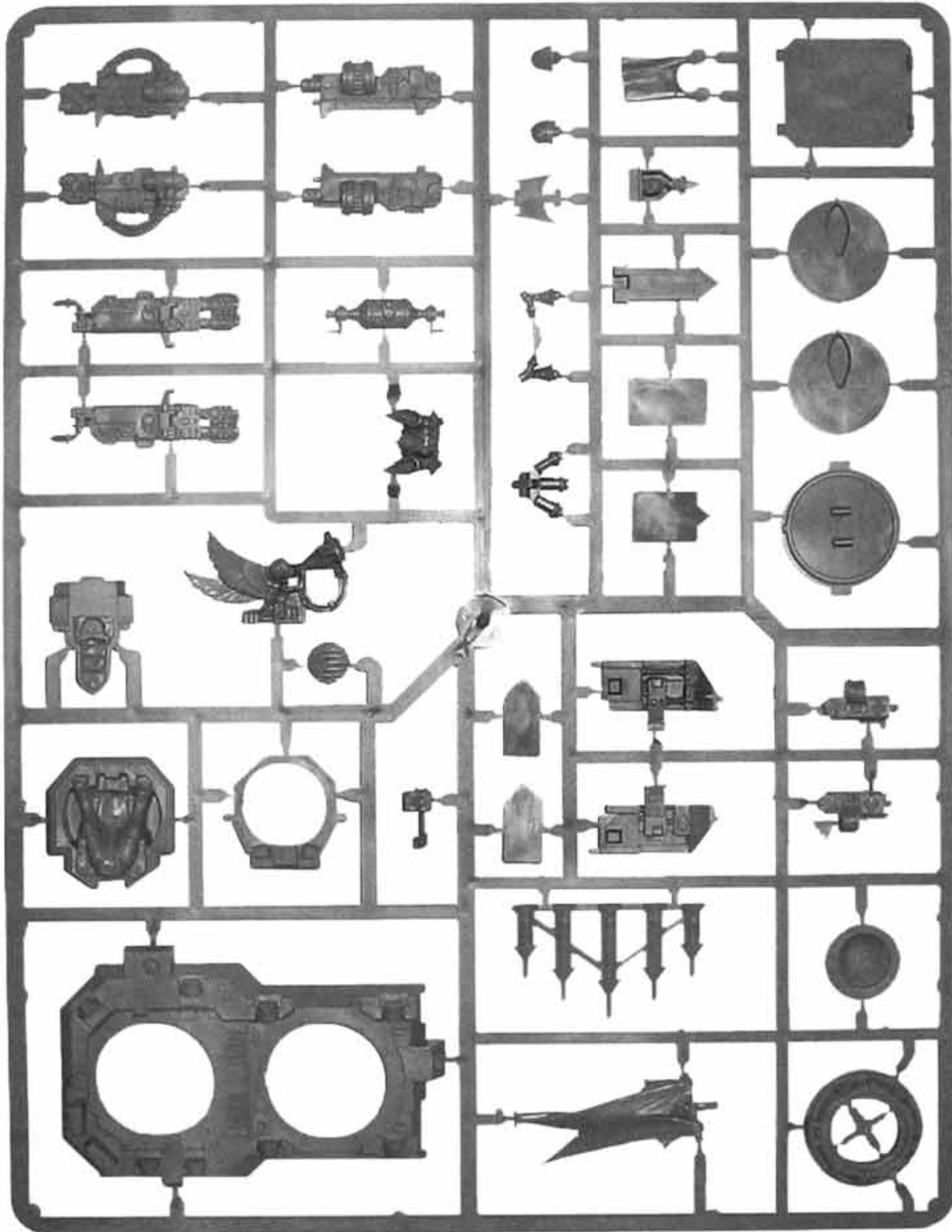

SISTERS OF BATTLE IMMOLATOR SPRUE (SHOWN 75% ACTUAL SIZE)
99390108001



HEAD SUPPORT



The Sister of Battle Exorcist is only available via Special Offer.

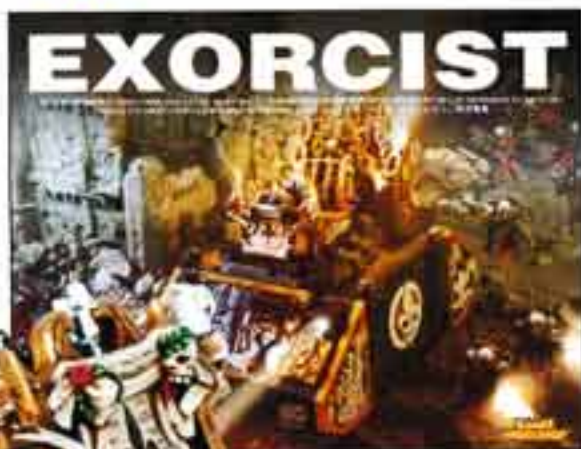

Sisters of Battle Exorcist Box (1)
99140108054

The Exorcist boxed set includes the Witch Hunter Decal Sheet (99510108004) shown in the HQ section and the Immolator Sprue (99390108001) and Rhino Hull Sprue 1 and 2 (99390199004 – 05) shown with the Immolator.



EXORCIST ORGANIST BODY
9947010805401



EXORCIST SERVITOR BODY
9947010805407



EXORCIST SERVITOR ARM
9947010805408



EXORCIST ORGAN KEYBOARD
9947010805403



EXORCIST ORGANIST HANDS
9947010805402

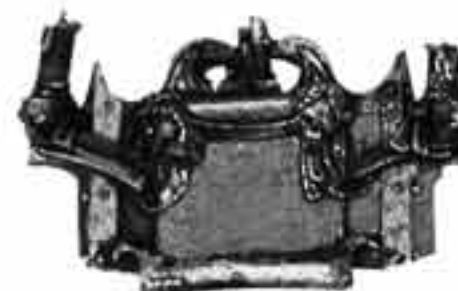

EXORCIST ORGAN FRONT
9947010805405



EXORCIST MISSILE WELL
9947010805409



EXORCIST ORGAN SIDES
9947010805406

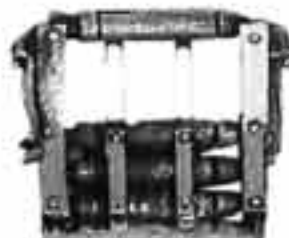

EXORCIST MISSILE RACK
9947010805410

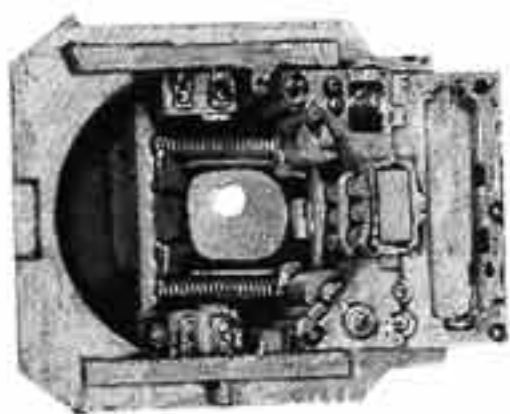

EXORCIST ORGAN BAY
9947010805404



EXORCIST PIPE BASE
9947010805414

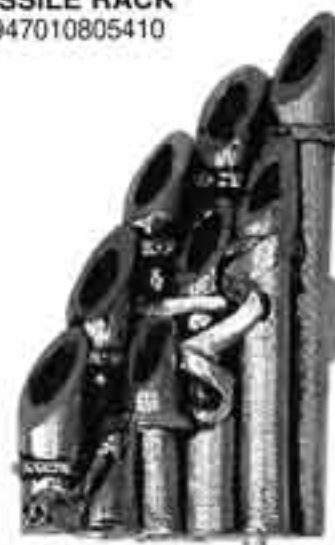

EXORCIST RIGHT PIPES
9947010805411



EXORCIST CENTER PIPES
9947010805413



EXORCIST LEFT PIPES
9947010805412



EXORCIST FRONT ARMOR
9947010805415



EXORCIST LEFT FRONT ARMOR
9947010805416



EXORCIST LEFT REAR ARMOR
9947010805419



EXORCIST RIGHT REAR ARMOR
9947010805418



EXORCIST RIGHT FRONT ARMOR
9947010805417

HEAVY SUPPORT



Sister of Battle w/ Heavy Bolter Blister (1)
99060108006



Sister of Battle w/ Heavy Flamer Blister (1)
99060108007



Sister of Battle w/ Multi Melta Blister (1)
99060108016



HEAVY BOLTER SISTER BODY
9947010800602



HEAVY FLAMER SISTER BODY
9947010800701



MULTI MELTA SISTER BODY
9947010801601



BATTLE SISTER HEAVY BOLTER
9947010800603



BATTLE SISTER HEAVY FLAMER
9947010800702



BATTLE SISTER MULTI MELTA
9947010801602



HEAVY FLAMER SISTER PACK
9947010800703



MULTI MELTA SISTER PACK
9947010801603

The Sister of Battle w/ Heavy Bolter includes one Sister of Battle Pack (9947010800401) shown in the Troops section.

CREATING INQUISITORIAL HENCHMEN

While the Daemonhunters and Witch Hunters ranges both provide ample figures to represent your Inquisitor and retinue, you may find yourself wishing to field a wargear selection that is not currently represented in the miniatures range or perhaps you wish to do a conversion for the sheer joy of it.

Here are a few examples of converted Henchmen that show how you are not limited to just one range when it comes to source material for your conversions.



A Mordheim Chaos Cultist has been converted to make a vicious-looking Henchman, perhaps a Warrior for a radical Daemonhunter?

By pairing the converted Gun Servitor and Sage in a mini-diorama, this conversion conveys an effective representation of how these Henchmen might interact.

This Missionary has traded in his staff and chainsword for a censer and scroll cases, while the Crusader below makes use of Bretonnian bitz.

As you can see, the only thing limiting your conversions is your imagination. If you can visualize it, you can probably find the bitz to make it. A quick perusal of this catalog will probably provide enough ideas to make the craziest Henchmen you can find!



All miniatures are supplied unpainted. Models, bits, and sprues are all shown actual size unless otherwise noted. Conversions may vary slightly from those shown.



COLORS OF WAR

KEY
 ■ Top Box(es): Basecoat Colors & Ink Washes ■ Bottom Box(es): Highlights ■ Mixed Colors



Bronzed Flesh, Boltgun Metal
Bleached Bone, Mithril Silver

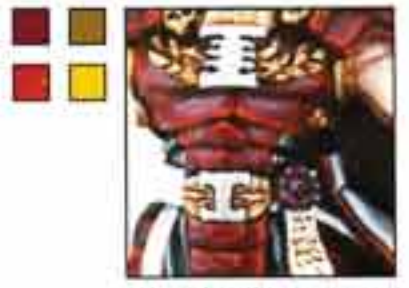

Scab Red, Dwarf Bronze
Blood Red, Shining Gold



BLOODY ROSE
Red Gore, Chaos Black
Blood Red, Codex Grey



EBON CHALICE
Chaos Black, Codex Grey
Shadow Grey, Skull White



Scab Red, Dwarf Bronze
Blood Red, Shining Gold



Codex Grey, Red Gore
Skull White, Blood Red



SACRED ROSE
Shadow Grey, Chaos Black
Skull White, Shadow Grey



ARGENT SHROUD
Boltgun Metal, Codex Grey
Mithril Silver, Skull White

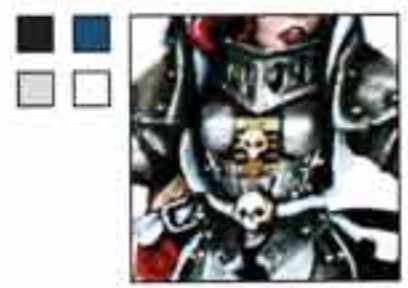

Boltgun Metal, Shadow Grey
Mithril Silver, Skull White

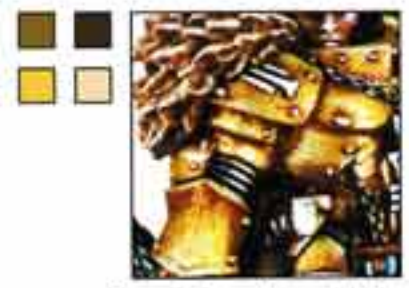

Brazen Brass, Scorched Brown
Burnished Gold, Bleached Bone



MARTYRED LADY
Chaos Black, Scab Red
Shadow Grey, Blood Red



VALOROUS HEART
Chaos Black, Codex Grey
Shadow Grey, Skull White



Chaos Black, Tanned Flesh
Shadow Grey, Dwarf
Flesh & Skull White



Shadow Grey, Dwarf Flesh
Skull White, Elf Flesh
& Skull White



Tanned Flesh, Scab Red
Elf Flesh, Scab Red
& Skull White



Scorched Brown, Bronzed
Flesh & Skull White



Chaos Black, Liche Purple
Fortress Grey, Liche
Purple & Skull White



Bestial Brown, Dark Angels
Green, Bleached Bone,
Goblin Green



Snakebite Leather, Blood Red
Bleached Bone,
Blood Red & Vomit Brown



Fortress Grey, Ultramarines
Blue, Skull White,
Ultramarines Blue & Skull White

All miniatures are supplied unpainted. Models, bits, and sprues are all shown actual size unless otherwise noted. Colors may vary slightly from those shown.

TACTICS

TIPS FOR WINNING WITH THE INQUISITION



- A. A Canoness with a jump pack, eviscerator, Mantle of Ophelia, and Cloak of St. Aspira can be a real headache for your opponent. She can boost into combat with nearly any enemy, burn a faith point for an invulnerable save, and cause all sorts of havoc. A Canoness is not to be underestimated in combat and can kill quite a few enemy models. If she is slain instead, you can celebrate! You've just gained 2 more faith points due to the *Martyrdom* rule.
- B. Seraphim with inferno pistols can charge into assault and then use the *Hit & Run* rule to end up next to a tank after the Assault Phase. During the Witch Hunters player's turn, the Seraphim can double-tap their inferno pistols and easily kill the tank. A somewhat riskier move is to get behind the tank, fire the inferno pistols only once, then follow up with a charge (Seraphim are equipped with krak grenades!) if the pistols fail to destroy the vehicle.
- C. A squad of Dominions armed with multiple flamers can use divine guidance to cause an impressive number of casualties on any foe, regardless of how good the enemy's armor save might be. Since Dominions must take a transport vehicle, an Immolator is usually a very good choice and can provide even more fiery death to your opponent.
- D. A Dreadnought armed with twin-linked lascannons and a missile launcher can hide behind terrain and step out during the 1st turn to hunt enemy tanks. A lack of ability to deal with armored vehicles is one of the weaknesses of the Grey Knights. Thus, this Dreadnought tactic neatly solves the problem and provides some extra hand-to-hand power in a pinch (especially since Grey Knight Dreadnoughts have Weapon Skill 5 and count as 10 models for outnumbering!).
- E. An Inquisitor armed with a psycannon and three Gun-Servitors (two with heavy bolters plus one with a plasma cannon) can add impressive firepower to any force for a reasonable point cost. In addition, the Inquisitor can take more items (such as the Emperor's Tarot to help you take the 1st turn or Mystics to attack enemy Deep Strikers) to improve his overall usefulness.
- F. A squad of Inquisitorial Stormtroopers armed with melta guns or plasma guns and mounted in a Rhino can be very useful in a drive-by capacity. The unit can get into position quickly (thanks to the Rhino) and fire the special weapons from the top hatch at nearby enemy tanks or squads. One way to add surprising hand-to-hand capability to such a unit is to upgrade one Stormtrooper to a Veteran Sergeant and give him a thunder hammer.



COUNTERTACTICS

TIPS FOR FIGHTING AGAINST THE INQUISITION

- A. It's nearly impossible to ignore a Canoness with a jump pack – so squish her early on and just accept that you'll be giving your opponent some free faith points. On the other hand, killing the Canoness gives you over 100 Victory Points and reduces the number of things you need to devote your attention to during the game, so taking her out is still a good idea.
- B. Seraphim should be a priority target when playing against any Witch Hunter opponent. Heavy weapons should be able to thin out a Seraphim Squad, and a dedicated hand-to-hand assault unit can usually handle what the Seraphim dish out. Just keep in mind that the Seraphim can and usually will be jumping away from you after the combat is over thanks to their *Hit & Run* rule. Also, you can keep your tanks away from your hand-to-hand units if you know your opponent is likely to field some Seraphim with inferno pistols.
- C. If you destroy the transport vehicle early on, it won't be too tough to single out the Dominion Squad for destruction. Heavy weapons or hand-to-hand combat will usually net you some Victory Points for each dead Dominion and keep those flamers from roasting your units.
- D. One of the main weaknesses of a Daemonhunters army is a lack of anti-tank firepower. For the most part, Dreadnoughts and Land Raiders are the true threats to tanks. If your tanks eliminate these units first, you can rampage nearly unchecked through the rest of the army. However, make sure to keep your eyes open for Inquisitorial Stormtroopers with melta-guns or multi-melta Gun-Servitors.
- E. The Inquisitor and his retinue may be well-armed, but they are still vulnerable to massed firepower. One good battle cannon shell or a few volleys of heavy bolter fire should eliminate the majority of the Inquisitor's resources.
- F. Rhinos aren't too tough to destroy, especially if the Stormtroopers are shooting out the top hatch (the vehicle then counts as open-topped). As long as you don't ignore the easily underestimated Rhino full of Stormtroopers, you shouldn't be surprised by it later on in the game.



SHOWCASE

Below: Terrance Peterson's Inquisitor and Retinue won first place at the 2004 Chicago Games Day Golden Demon painting competition.



Above: Kanon Bene's Inquisitor Rhino won second place at the 2004 LA Golden Demon painting competition.



Below: Tom Schadle's Inquisition Stormtroopers won first place in the Warhammer 40,000 Squad category at the 2004 Baltimore Games Day Golden Demon painting competition.



Right: Richard Henderson's battle scene, "In The Emperor's Name," won second place at the 2003 UK Games Day Golden Demon painting competition.



SHOWCASE



Right: This spectacular Brother Captain Stern was painted by Liliana Troy for the Baltimore 2003 Golden Demon painting competition.



Below: Garrick Eisenbers won 2nd place for the Warhammer 40,000 Single Miniature in the Los Angeles 2003 Golden Demon painting competition.



Above: Jason Laudiano's Redeptor Kyrinov won first place at the 2004 Los Angeles Golden Demon painting competition.

All miniatures are supplied unpainted. Models, bits, and sprues are all shown actual size unless otherwise noted. Contents may vary slightly from those shown.



SHOWCASE

Below: Gary Hodgson's Grey Knight Terminators won first place in the Warhammer 40,000 Squad category at the 2004 Canada Golden Demon painting competition.



Right: Jakob Nielson won first place for the Warhammer 40,000 Single Miniature in the UK's 2002 Golden Demon competition.



Left: James Kennard's Inquisitor was a runner-up at the 2004 Chicago Games Day Golden Demon competition.



Right: Doug Jones' Inquisitor was a runner-up at the 2004 Chicago Games Day Golden Demon competition.



Below: Tom Schadle's Ordo Hereticus Inquisitor was a runner-up at the 2004 Baltimore Games Day Golden Demon competition.

Lower Right: Steven Song's Inquisitor and Retinue won third place at the 2004 LA Games Day Golden Demon painting competition.



SHOWCASE

Michael Anderson's Daemonhunter Warband won second place at the 2003 UK Games Day Golden Demon painting competition.



Below: For his extraordinary efforts, Jason Richards received a Silver Demon at the Baltimore 2003 Golden Demon competition with this mighty Inquisitor Lord.



ALTERNATE MODEL – HQ
Inquisitorial Retinue

COMPONENTS FOR 4 COMPLETE MODELS

- 99380203004 Bret. Foot Command Sprue
- 99380105002 Cadian Shock Troops Sprue
- 9947139900109 Covenant Sigils Sprue

COMPLEXITY RATING



THIS CONVERSION CONTAINS THE SPECIAL OFFER BITZ SHOWN HERE
See the catalog introduction for more information.



COVENANT SIGIL SPRUE
9947139900609



ALTERNATE MODEL – TROOPS
Inquisition Stormtroopers

COMPONENTS FOR 4 COMPLETE MODELS

- 9947010516502 Cadian Kasrkin Backpack (x3)
- 9947010516503 Cadian Kasrkin 1
- 9947010516506 Cadian Kasrkin 4
- 9947010517004 Cadian Plasma Gun
- 9947010517008 Cadian Plasma Backpack
- 9947139900607 Eisenhorn Sigils Sprue (x4)

COMPLEXITY RATING



THIS CONVERSION CONTAINS THE SPECIAL OFFER BITZ SHOWN HERE
See the catalog introduction for more information.



EISENHORN SIGIL SPRUE
9947139900607



NECRONS

Despite the staccato bursts of big shootas and the bellowing war cries of the greenskins, the Necron Warriors advanced silently across the barren plains. Here and there, the great fusillade of the Orks would drop or dismember one of the mechanical monstrosities, but more often than not, the mechanical warrior would rise out of the dust and continue to march closer.

On the flanks, Destroyers and Heavy Destroyers skimmed over the desert floor, swiveled their cannons, and discharged arcane green bolts that ripped through Ork Dreadnoughts with relative ease. Looming over the oncoming forces was a mighty Monolith, an immense pyramid crackling with incandescent energies.

For the only time in his short and brutal life, Ork Warlord Gruzgutz felt something akin to the human emotion of regret. If only those weedy Grots hadn't disturbed that cursed tomb...

Across the galaxies, something ancient and sinister stirs in the darkness. The skeletal warriors of the Necron race have lain undisturbed and dormant for millions of years, but the horrors are awakening. No longer living, Necrons long ago traded their mortality for metal shells and eternal servitude to the star-born gods, the C'Tan. Now, legions of undying warriors are moving once more and seek domination of all that live.

Below: Jerry Doyle made this great Necron Lord conversion for his 2002 Dallas Grand Tournament army.

Below Right: Bryan Jenson's Necron Lord. See the rest of his army in the Showcase section.

Fighting Style

Necrons can withstand a tremendous amount of damage thanks to their high Toughness, excellent armor, and most of all, the *We'll Be Back!* rule, which allows the mechanical beings to self-repair. Nothing is more demoralizing to a foe than to have all the Necron casualties from the last round stand back up again ready for more battle. However, remember that this implacable nature alone will not ensure victory.

To win the game, a Necron player must do more than receive the enemy's fire and must deliver his own killing blow as well. The Necrons are unique in that they use deadly Gauss technology that can take out vehicles and strip any foe down to its constituent atoms. While the bulk of a Necron army is not fast, there are numerous squads, like Wraiths, that can *Deep Strike* or move quickly or other squads, like Flayed Ones, that can *Infiltrate* to disrupt the enemy. Destroyers and Heavy Destroyers can provide long-range support, and Necron players should not overlook the Scarab Swarms that can tie up enemy forces. While an enemy shifts to counter each of these individual threats, the Necrons move forward to bring more weapons to bear.

Collecting a Necron Army

We always suggest starting a new army by fulfilling the requirements the Standard Missions Force Organization chart. A Necron Lord (HQ) and two units of Necron Warriors (Troops) is a fine start and an imposing center to any army. Bulking up on additional Necron Warriors is always advisable, as they can destroy vehicles, are formidable in hand to hand, and help keep the army from

Right: William Nicholson made this Necron Lord complete with Resurrection Orb for his 2002 Dallas GT army.



Phasing out – a cataclysmic event that causes the army to disappear mysteriously when its numbers drop below 25% of its original total.

Necron commanders have a variety of choices to enlarge the army. Pariahs are anti-psykers and are equipped for hand-to-hand combat. Immortals are tougher and provide more firepower than Warriors. Flayed Ones are close combat specialists that *Infiltrate* the enemy and literally skin them alive. Fast Attack options include the scuttling Scarab Swarms, the floating Wraiths, and the heavily armed Destroyers. Necron players must make a few tough decisions as all their heavy support choices are excellent. The Tomb Spyderys can aid Necrons in their self-repair ability and also create Scarab Swarms on the battlefield. Heavy Destroyers wield the mighty Heavy Gauss Cannon. The Monolith, in addition to being a huge and impressive model, is a valuable (if ponderous) transport craft that allows Necrons anywhere on the battlefield to vanish and re-emerge from the Monolith's portal.

Carefully chosen and used together to support each other on the battlefield, the Necrons are nigh unstoppable and will soon have whole galaxies (or at least all of your opponents) quaking in their boots.

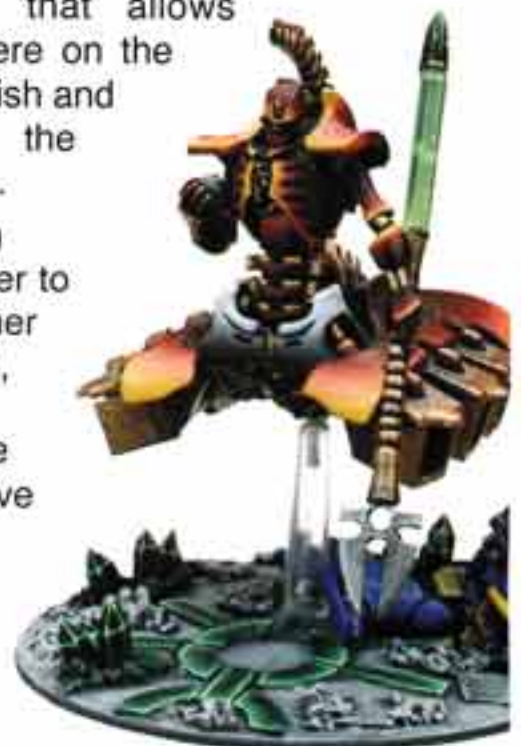



Necron Battleforce Box 99120110003

- 20 Necron Warriors
- 5 Necron Scarab Swarms
- 3 Necron Destroyers
- 1 Necron Decal Sheet



GETTING STARTED



This 64-page rulebook contains painting and modeling guides, background, and the full rules for fielding a force of Necrons.

**Codex:
Necrons**
60030110001

The most sophisticated of the C'Tan's servants, Necron Lords act as leaders and energy loci for the Necron Warriors. Clad in crumbling vestments and wielding ancient, arcane staffs, Necron Lords are a chilling sight on the battlefield and direct their warriors' attack in unnatural silence.

HQ



C'Tan Deceiver Box (1)
99110110020



DECEIVER BODY
9947011002004



Necron Lord Blister (1)
99060110009



LORD BODY
9947011000901



LORD SPRUE
9947011000902



NECRON ROD SPRUE
99390110001



DECEIVER RIGHT ARM
9947011002003



DECEIVER LEFT ARM
9947011002005

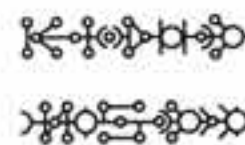

DECEIVER ROCKS
9947011002008



DECEIVER HEAD
9947011002001



DECEIVER CLOAK
9947011002006



DECEIVER BASE
9947011002007



DECEIVER HORNS
9947011002002



HQ



C'Tan Nightbringer Box (1)
99110110014



NIGHTBRINGER BODY
9947011001402



NIGHTBRINGER RIGHT ARM
9947011001401



NIGHTBRINGER LEFT ARM
9947011001403



NIGHTBRINGER LEGS
9947011001405



NIGHTBRINGER BASE
9947011001406



NIGHTBRINGER CLAW
9947011001404

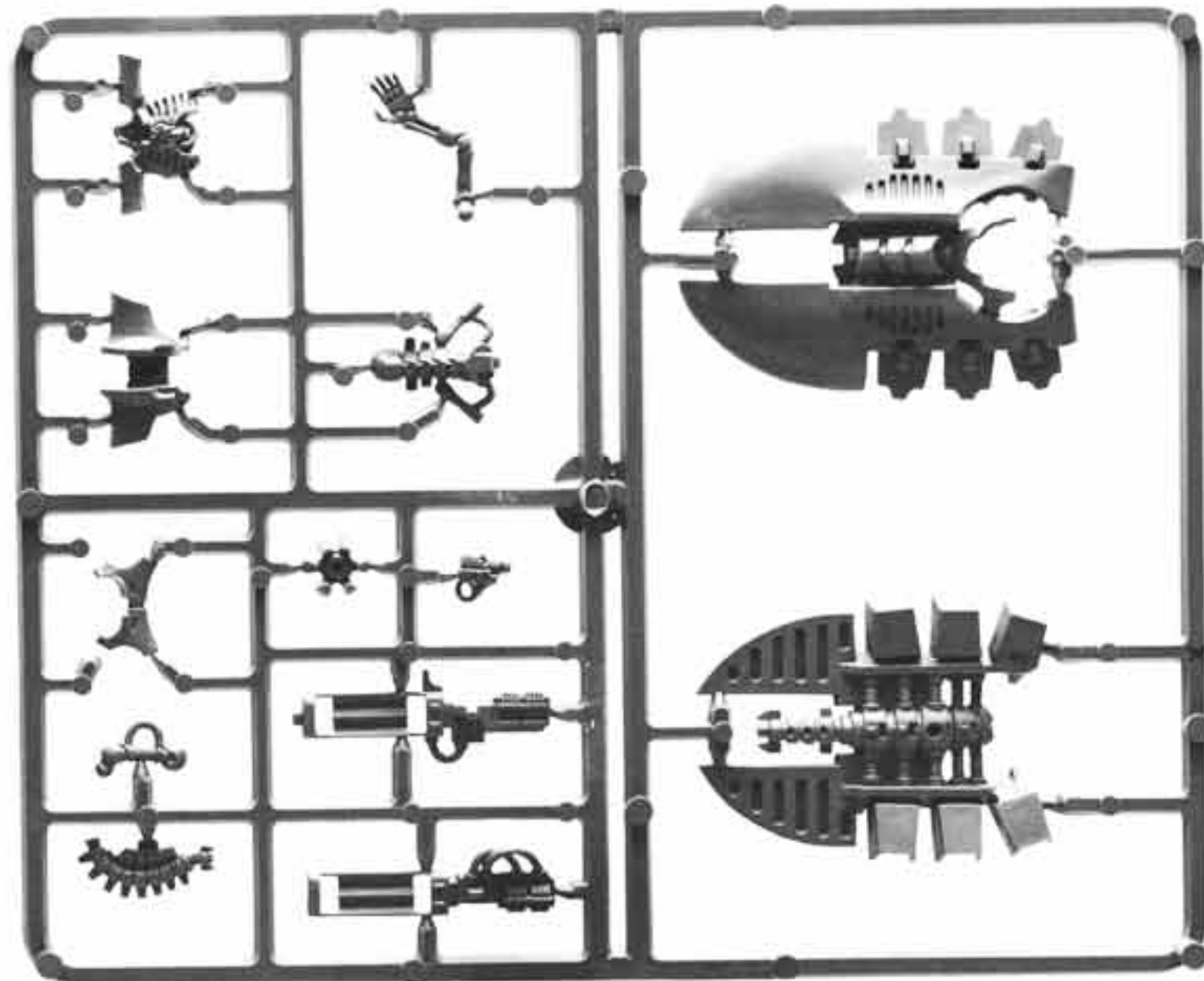

NECRON DESTROYER SPRUE (SHOWN 90% ACTUAL SIZE)
99390110002



Destroyer Lord Box (1)
99140110016



The Necron Destroyer Lord comes with the Necron Rod Sprue (99390110001) shown on the previous page and the Necron Decal Sheet (99510110001) shown in Fast Attack.



DESTROYER LORD STAFF 1
9947011001604



DESTROYER LORD STAFF 2
9947011001605



DESTROYER LORD ACCESSORY SPRUE
9947011001603



DESTROYER LORD SPINE
9947011001602



DESTROYER LORD BODY
9947011001601

ELITES



Pariah Blister (Random 1)
99060110019



PARIAH BLADE
9947011001907



PARIAH WEAPON 1
9947011001905



PARIAH WEAPON 2
9947011001906



PARIAH BODY 1
9947011001901



PARIAH BODY 2
9947011001902



PARIAH BODY 3
9947011001903



PARIAH BODY 4
9947011001904

Both Pariahs and Immortals come with the Necron Rod Sprue (99390110001) shown in HQ.



Immortal Blister (Random 1)
99060110010



IMMORTAL SPRUE
9947011001006



IMMORTAL GUN
9947011001005



IMMORTAL BODY 1
9947011001001



IMMORTAL BODY 2
9947011001002



IMMORTAL BODY 3
9947011001003



IMMORTAL BODY 4
9947011001004

BURNISHED METALS

Here are three different ways to create a metallic look for your Necrons. Whether you choose traditional silver or some other color scheme, you'll find these techniques useful.

BURNISHED SILVER

Prime your model black and drybrush it with Boltgun Metal. Then, thin some Boltgun Metal paint and begin building up the highlights by painting them directly on the model. The next highlights should be Chainmail and then Mithril Silver. If you want a darker color, mix black or dark blue into the Boltgun Metal before you begin drybrushing.



BURNISHED GOLD

Prime your model black. Next, drybrush your Necron with Brazen Brass and then Shining Gold. Thin down a bit of Shining Gold and begin building up the highlights by painting them directly onto the model. The next layer of highlights should be Burnished Gold. Next, add a little Mithril Silver to the Burnished Gold to get that burnished metal effect. Be careful not to add too much silver, as it will make the metal look grey rather than providing a nice shine. Remember to thin your mix.



BURNISHED COLOR METAL

Many players like a burnished metal look for their Necron Warriors. Burnished metal is highly polished, and one way to simulate its appearance is to mix Mithril Silver into your base metal color. Add a bit more Mithril Silver for each highlight. Thin your metallic paint slightly and pull the brush toward the area you wish to highlight.

NONMETALLIC METAL

Creating a metallic look using flat colors takes a little more time, but the outcome looks fantastic! Here is a nonmetallic Necron from Jason Phillips's 2002 Los Angeles Grand Tournament army. For this effect, start with a very dark base color, highlight up very quickly, and finish with a small final highlight of white.





ELITES



FLAYED ONE BODY 1
9947011001501



FLAYED ONE BODY 2
9947011001502



FLAYED ONE BODY 3
9947011001503



FLAYED ONE BODY 4
9947011001504



FLAYED ONE CLAWS 2
9947011001506



FLAYED ONE CLAWS 1
9947011001505



Flayed Ones Blister (Random 2)
99060110015

TROOPS



Necron Warriors Box
(12 Warriors & 3
Scarab Bases)
99120110001

The Necron Warriors come with the Necron Rod Sprue (99390110001) shown in HQ.

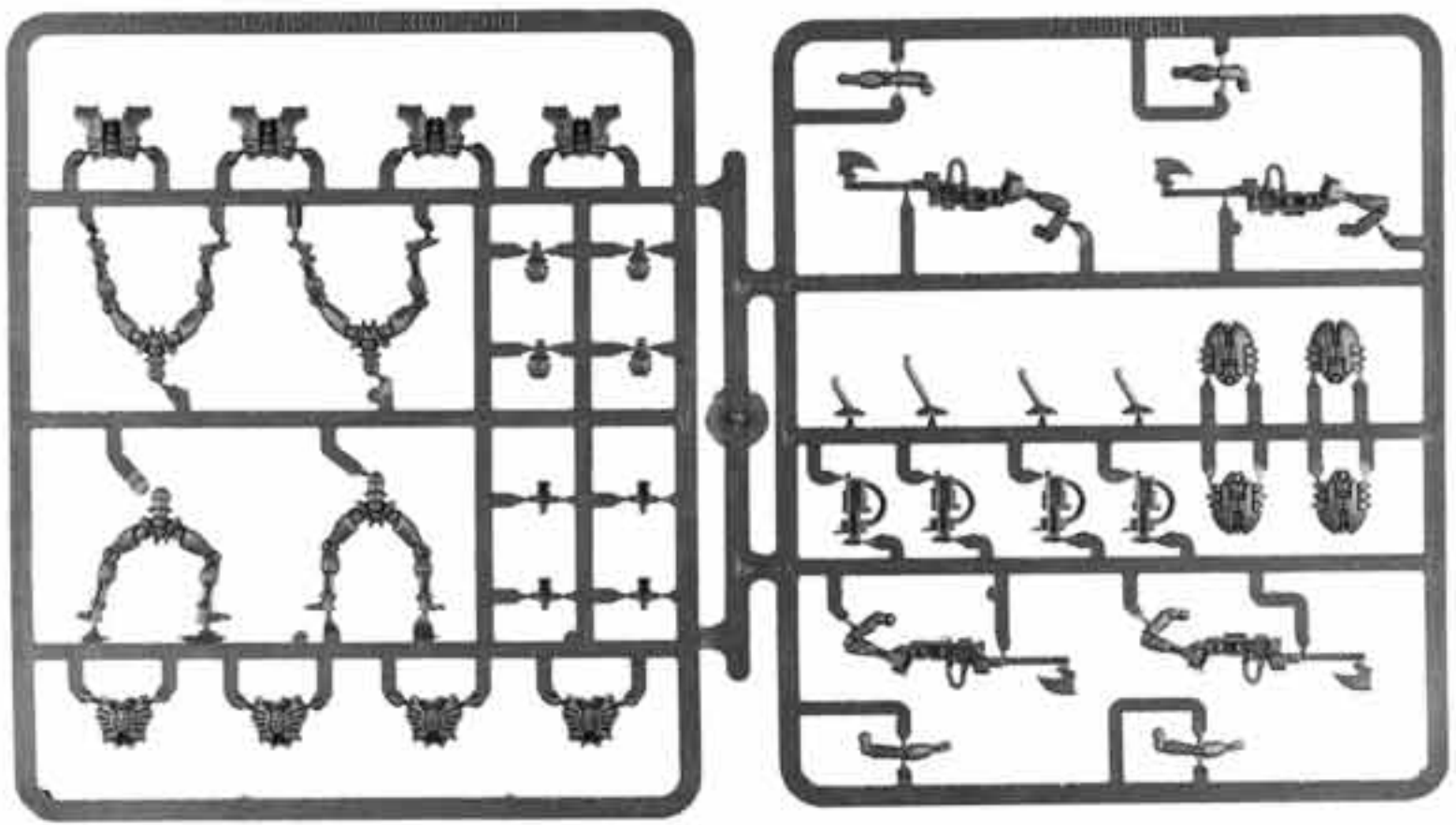

NECRON WARRIOR SPRUE (SHOWN 50% ACTUAL SIZE)
99390110001

All miniatures are supplied unpainted. Models, bits, and sprues are all shown actual size unless otherwise noted. Contents may vary slightly from those shown.

FAST ATTACK

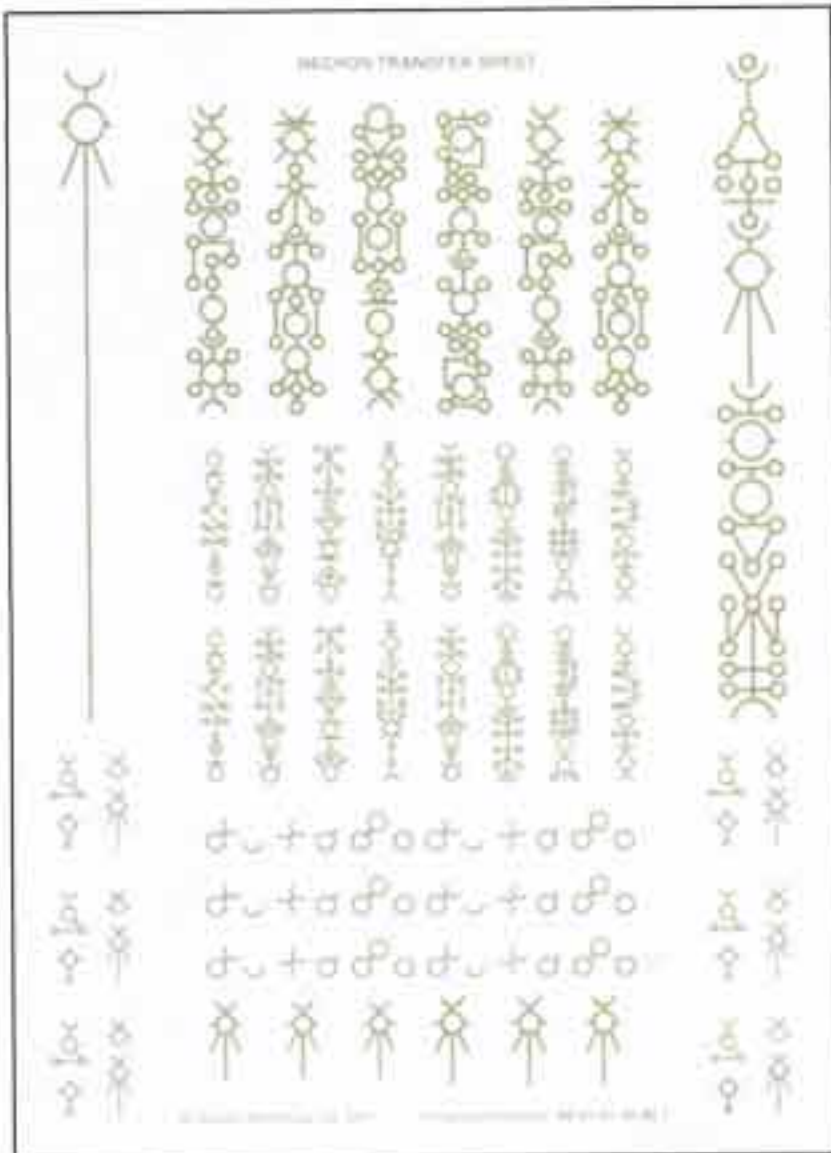

Necron Destroyer Box (1)
99120110002

The Destroyer comes with the Necron Rod Sprue (99390110001) and Destroyer Sprue (99390110002) shown in HQ.

NECRON DECAL SHEET (SHOWN 70% ACT. SIZE)
99510110001



WRAITH BODY 1
9947011001701



WRAITH BODY 2
9947011001702



WRAITH TAIL 1
9947011001705



WRAITH TAIL 2
9947011001706



WRAITH ARMS 1
9947011001703



WRAITH ARMS 2
9947011001704



WRAITH ARMOR
9947011001707



Wraith Blister (Random 1)
99060110017

SPEED PAINTING NECRONS

Necrons are a great army to paint quickly, because drybrushing is a fast and effective way to highlight metal. Follow these steps to get a tournament-ready army in no time!

STEP 1

After cleaning and assembling your models, spray them with Chaos Black primer (not shown). When dry, spray them with Boltgun Metal.



STEP 2

Paint the model with three different ink wash colors. Apply each to random sections of the model and allow the washes to run together. The following inks were used on this model: Brown, Black, and Dark Green. Each was diluted slightly with water, and a drop of Gloss Varnish was added to give the model more shine.



STEP 3

Once the model dries, drybrush it with Boltgun Metal. Next, pick out the eyes and gun tubing with Snot Green.



STEP 4

Highlight the eyes and gun tube with Scorpion Green. Then, paint Shining Gold on the chest icon, glue the rod in place, and finish the base of the model.





HEAVY SUPPORT

The Necron Heavy Destroyer includes the Necron Rod Sprue (99390110001) and Necron Destroyer Sprue (99390110002) shown in HQ and the Necron Decal Sheet (99510110001) shown on the previous page.

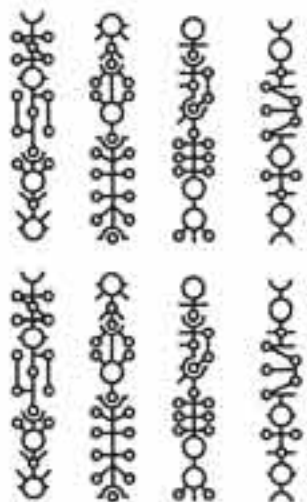

Necron Heavy Destroyer Box (1)
99140110018



TOMB SPYDER BODY
9947011001302



**Tomb Spyder with Particle
Projector Cannon Blister (1)**
99060110013



Tomb Spyder Blister (1)
99060110011

The Tomb Spyder and Tomb Spyder with Particle Projector Cannon both include the Necron Rod Sprue (99390110001) shown in the HQ section.



**TOMB SPYDER
MUZZLE**
9947011001304



TOMB SPYDER CLAW
9947011001303



TOMB SPYDER HEAD
9947011001301



**TOMB SPYDER PARTICLE
PROJECTOR CANNON**
9947011001306



TOMB SPYDER CLAW ARM
9947011001305



TOMB SPYDER LEGS (RANDOM 1)
9947011001307

HEAVY SUPPORT

The Necron Monolith comes with the Necron Decal Sheet (99510110001) shown in Fast Attack.



Necron Monolith Box (1)
99120110004

The Monolith combines the properties of transport craft, armored destroyer, and Necron power icon. Its ponderous form floats across the battlefield, while its crystal core pulses with sickly energy and powerful beams of gauss lightning whip from its weapon mounts. The front section is capable of opening a dark portal and transporting Necrons around the battlefield to cause havoc.

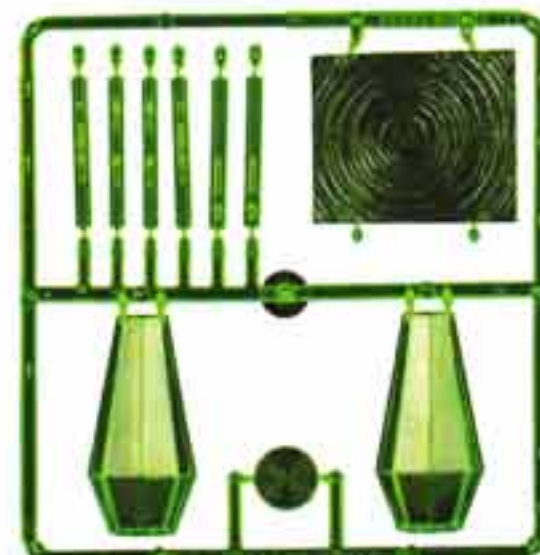

NECRON MONOLITH CRYSTAL SPRUE
(SHOWN 50% ACT. SIZE)
99390110005

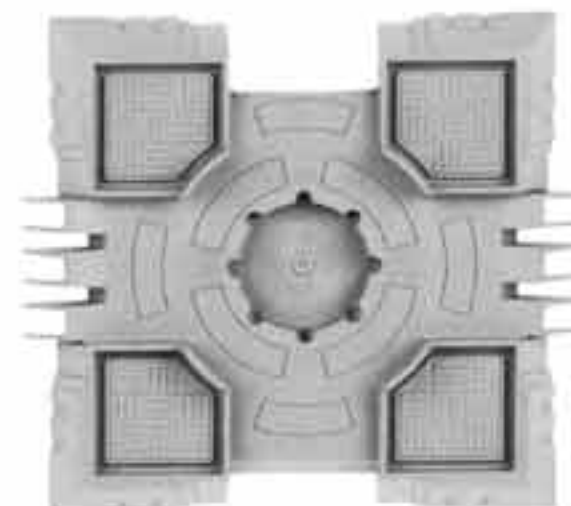

NECRON MONOLITH BASE
(SHOWN 50% ACT. SIZE)
99390110004

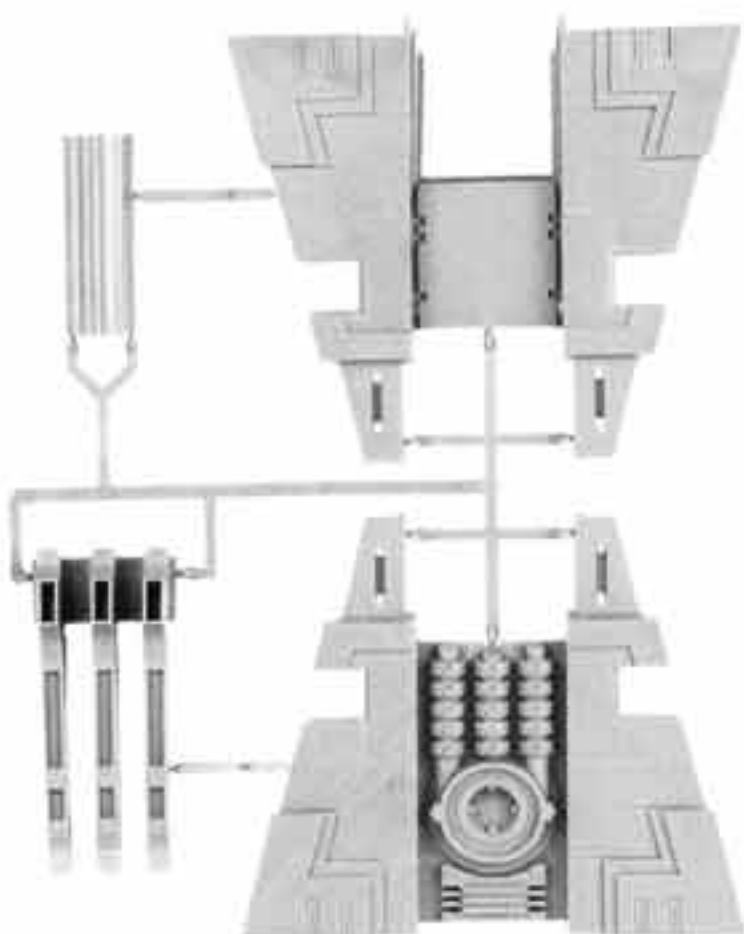

NECRON MONOLITH FRONT SPRUE
(SHOWN 50% ACT. SIZE)
99390110006

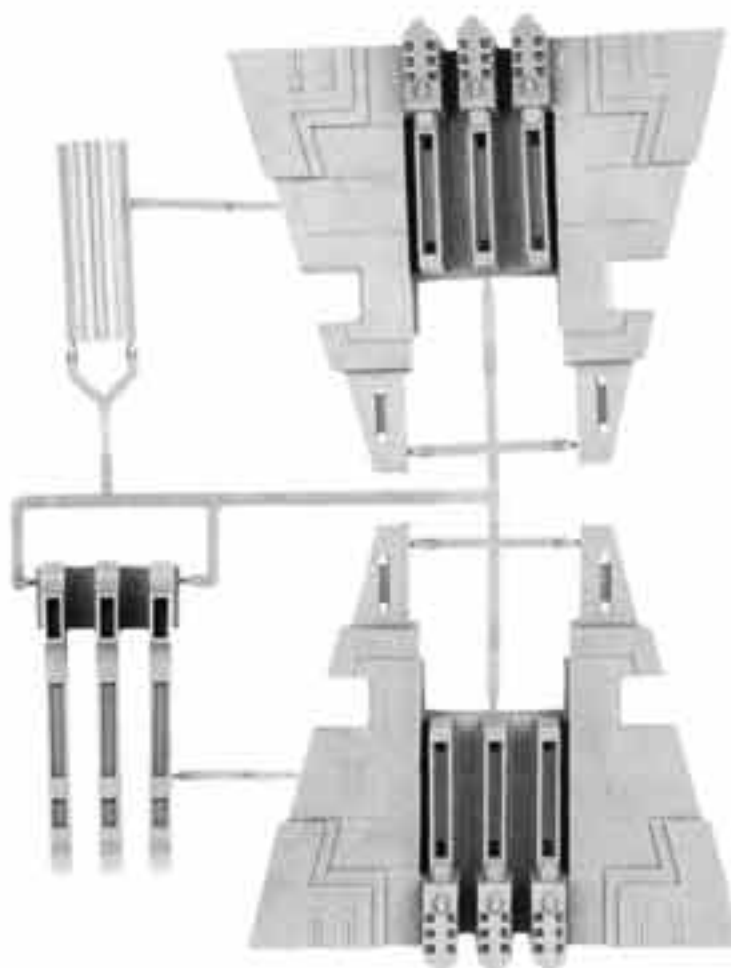

NECRON MONOLITH SIDES SPRUE
(SHOWN 50% ACT. SIZE)
99390110007

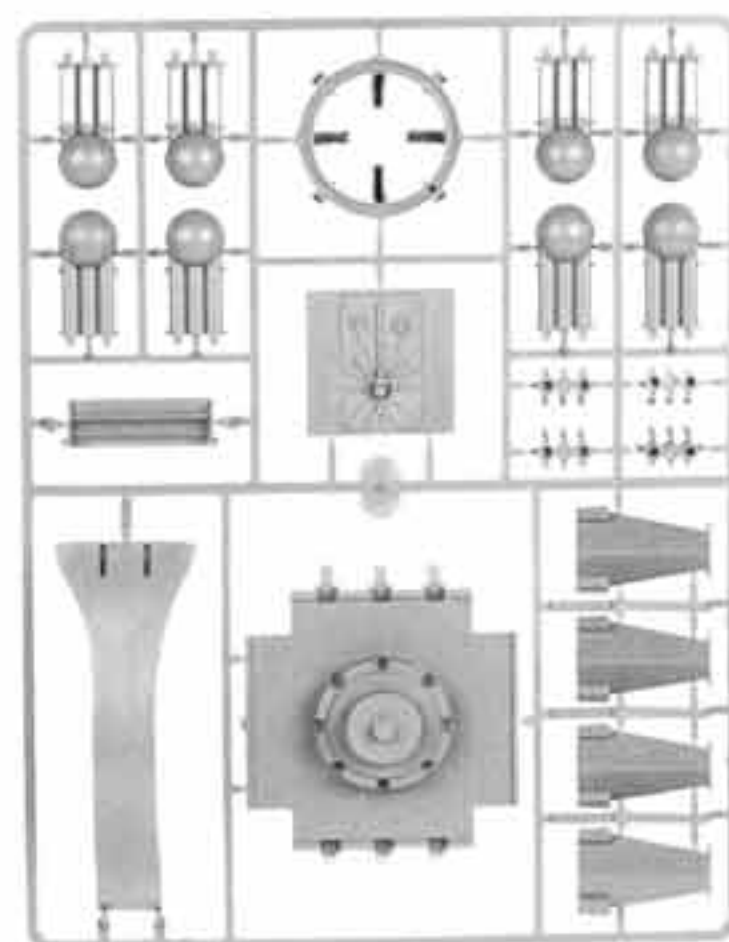

NECRON MONOLITH ACCESSORY SPRUE
(SHOWN 50% ACT. SIZE)
99390110003



COLORS OF WAR

KEY

■ Top Boxes: Basecoat Color ■ Bottom Box(es): Highlight Color or Ink Washes ■ Mixed Colors



*Shining Gold, Chestnut Ink
Burnished Gold, Shining Gold*



*Chaos Black, Boltgun Metal
Ultramarines Blue, Ice Blue*



*Chaos Black, Boltgun Metal
Red Gore, Blood Red*

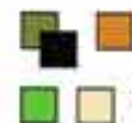

*Camo Green & Chaos Black, Vomit Brown
Scorpion Green, Bleached Bone*



*Chaos Black & Chainmail
Boltgun Metal, Mithril Silver*



*Codex Grey, Skull White
Brown Ink & Green Ink*



*Regal Blue, Vomit Brown
Enchanted Blue, Vomit Brown & Skull White*



*Chaos Black, Space Wolves Grey
Space Wolves Grey & Skull White, Skull White*

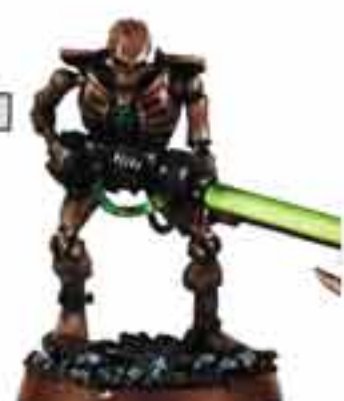

*Dark Flesh & Brazen Brass
Dwarf Bronze, Mithril Silver*



Above: Evan Lougheed has developed his own color scheme and used red instead of the usual metallic colors. Here, we show his Immortals and Pariahs, two squads he fields regularly when his Necrons do battle.

TACTICS



TIPS FOR WINNING WITH NECRONS

- A. Necron Destroyers are horrifically efficient at killing enemy infantry, and their jetbike movement makes performing this role even easier. One interesting tactic to use with Necron Destroyers is to Turbo Boost 24" into cover with a unit of Destroyers and line up for side shots on tanks or in such a way as to ignore the cover behind which your opponent has positioned his vulnerable troops.
- B. The Veil of Darkness is an excellent tool to get your expensive Lord out of close combat and to move him and a nearby unit (ideally, a group of tough, well-armed Immortals) into position for a devastating barrage of firepower on an unsuspecting enemy unit. The Veil is also great for attacking units that are in cover (or even out of sight altogether) or out of range of your other units. Do not use the Veil if doing so would put your precious Necron Lord in range of too many enemy guns.
- C. Scarab Swarms can *Deep Strike* down into the enemy's formation and cause all sorts of disruption. Since they are fearless, they can also tie up a valuable assault unit or draw heavier guns away from your valuable Necron Warriors. At 12 points each, Swarms are an affordable distraction that your opponent will likely either under- or over-estimate. Add in some disruption fields, and the Swarms can handle Sentinels, War Walkers, and occasionally even Dreadnoughts (or at least tie them up in combat for turn after turn).
- D. A Necron Lord with a Destroyer Body and a Resurrection Orb is ideal to keep your Necron Warriors around even in the face of overwhelming firepower or power weapon attacks. The speed and durability of the Destroyer Body can bring your Lord's Resurrection Orb wherever it is most needed and give you the opportunity to add the Lord's own hefty assault power to any developing close combat to make the results rise dramatically in your favor. Add in a warscythe and a phase shifter, and the Lord can take on enemy HQ models in hand-to-hand (and even stand toe-to-toe with a Space Marine Chaplain) and can assist in a Wraith assault.

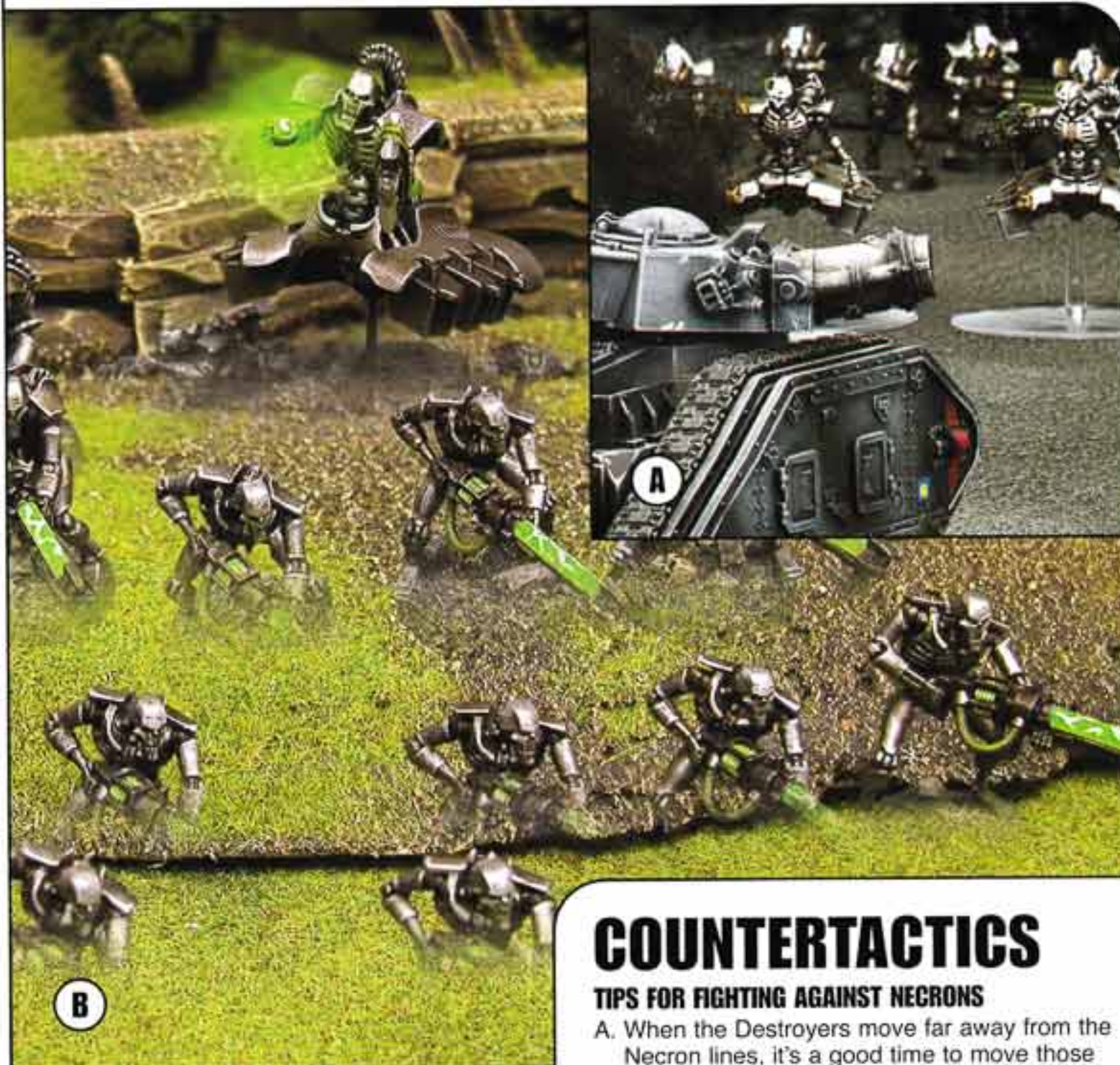

COUNTERTACTICS

TIPS FOR FIGHTING AGAINST NECRONS

- A. When the Destroyers move far away from the Necron lines, it's a good time to move those jump infantry models into assault (or if you are playing Tau, hit the Destroyers with a truckload of burst cannon shots).
- B. Using the Veil of Darkness to move around a large group of Necrons can be dangerous, because the scatter distance can move the target point close to impassible terrain or enemy models. Keeping some assault units nearby can help make this tactic a lot more risky for the Necron player.
- C. Sometimes, it's best to fight fire with fire. If you find Swarms making your life difficult, one of the best ways to handle them is to go ahead and assault. If you can outnumber the Swarms and win combat, the Swarms will take extra Wounds (because they are *Fearless*) and will go away that much faster. The sooner you drive off the Swarms, the better! Remember that template weapons cause double Wounds on Swarms. Thus, even a simple flamer can exterminate these annoying vermin.
- D. Try to kill the Necron Lord as early in the game as possible. If it's not possible to do so, keep in mind that the Lord, while a scary opponent, has only 3 Attacks. It's possible to swamp him with large groups of warriors (such as an Imperial Guard Infantry Platoon, Grots, or Termagants) to tie him up in combat for a number of turns. If the Lord is on a Destroyer body, tying him up in combat is even better, as he can't use all that lovely jetbike movement he paid for! In general, one of the best things you can do in a fight against Necrons is to attempt to reduce the army to 25% or less of its original numbers and force the army to disappear per the Phase out rule.



SHOWCASE



Left: Golden Demon Youngblood contestant Brandon Green won second place at Canadian Games Day with this Nightrbringer entry.



Above Right: Painted by Matt Parkes, this Destroyer Lord won second place in the Warhammer 40,000 Monster category at the 2003 U.K. Golden Demon Painting Competition.

Left: Joe Orteza won first place at the 2004 Atlanta Golden Demon Painting Competition with his "Along Came a Spider" in the Best Battle Scene category.



Left and Above: Bryan Jenson took a different approach to creating a color scheme for his Necrons by using bright oranges and deep bronze colors to make a visually stunning army.

All miniatures are supplied unpainted. Models, bits, and sprues are all shown actual size unless indicated as stated. Contents may vary slightly from those shown.

SHOWCASE



Jason Phillips painted a complete "nonmetallic" Necron army for the 2002 Los Angeles Grand Tournament. Shown here are his Warriors, Wraiths, and Necron Lord.



ALTERNATE MODEL – ELITE Necron Pariah

COMPONENTS FOR 1 COMPLETE MODEL

- 99390110001 Necron Gauss Rod Sprue
- 9947011001605 Destroyer Lord Staff 2
- 9947020711101 Catapult Crew 1

COMPLEXITY RATING



ALTERNATE MODEL – HEAVY SUPPORT Necron Tomb Spyder

COMPONENTS FOR 1 COMPLETE MODEL

- 99390110002 Necron Destroyer Sprue
- 99390113001 Tau Gun Drone Sprue
- 9947010200605 F. Bile Chirurgeon Arm 1 (x2)
- 9947010200606 F. Bile Chirurgeon Arm 2 (x2)
- 9947011001301 Necron Tomb Spyder Head
- 9947011001303 N. Tomb Spyder Claw 2 (x2)
- 9947011001305 N. Tomb Spyder Claw 1 (x2)
- 9947011001307 N. Tomb Spyder Legs (x3)
- 9947011001406 Nightbringer Base

COMPLEXITY RATING



ORKS

With guttural howls, Mekboy Krudz and his Burna Boyz stormed past the broken remnants of a mob of Slugga Boyz and charged the trench. With several ominous whooshes, great gouts of oily flames shot into the hastily dug Imperial positions. The blackened and horrible things that still moved and screamed in the trench were loudly dispatched by slugga fire.

For a single moment, the entire squad paused in a very un-Orky fashion and twisted nozzles, adjusted goggles, and tapped fuel tanks. Assured that their gear was working, the Mekboy led his boyz down the trench and towards the bunker that had caused the Orks so much trouble.

“Dem ’Oomies is gonna pay,” growled Krudz.

Orks are the most widespread of all alien races known to the Imperium of Man. Orks are savage, barbarous, and so totally warlike that their thirst for battle and conquest is unquenchable. Orks don't negotiate – they fight, and they like it that way.

Fighting Style

Ork Warbosses have long been accused of using unsubtle, sledgehammer tactics. These charges are undeniably true, but then again, so is the bloody evidence of their success. Even basic Orks are fearsome hand-to-hand opponents. The fact that Orks are relatively cheap points-wise means that there are usually a large number of them. While a frontal assault by overwhelming numbers is

an obvious place to start, a cunning Ork Warlord can make an infinite amount of adjustments to this theme.

For instance, an Ork mastermind with a fondness for mechanized movement can easily invest in lots of Trukks to speed his force across the board. Dreadnoughts and Killer Kans make awesome support for an infantry advance, and the potential of facing as many as nine Killer Kans on the battlefield has caused many an Ork opponent to quake in his boots. Screens of Ork bikers and Grots can soak up a lot of enemy firepower and allow large Boyz mobs to advance with a minimum of losses, and a Warlord can trim the foe down before assaulting by fielding lots of shooty stuff like plenty of big shootas, a few pieces of Grot artillery, and a motley assembly of Wartraks. There are many brutal tactics to try, but remember, the best ones are the ones that result in your foe dripping off the end of your choppas! Waaagh!!!

Collecting an Ork Army

We always suggest starting a new army by fulfilling the requirements of the Standard Missions Force Organization Chart. For Orks, this means a Warboss for the HQ choice and two Troops choices – pretty much an ideal situation for getting started and forming the center of your army. Expanding the Ork army after you've collected and painted your HQ and two Troops choices is easy. Ork armies have everything a Warboss could want: rock-hard infantry, screening troops, lots of fast attack options, and plenty of heavy support. Having a range of models will allow the Ork player to change his forces from battle to battle. For one game, he can field high numbers of hand-to-hand fighters to swamp

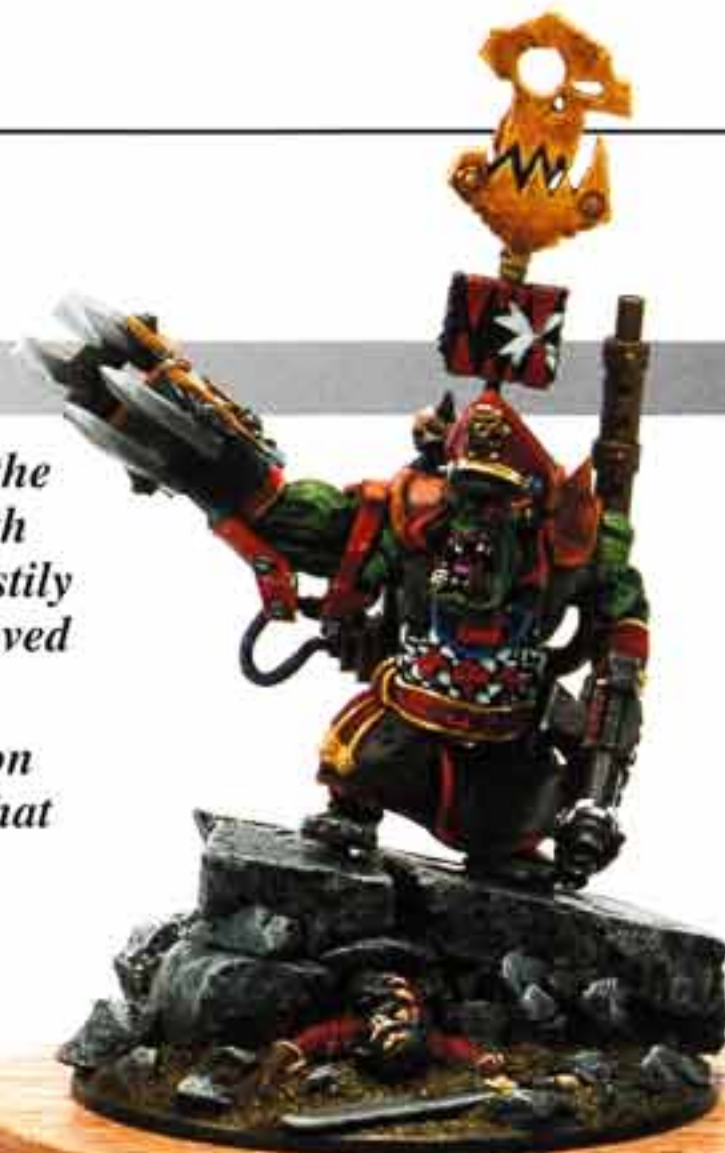

Benjamin Hardy's Kommissar Yarsnikk won first place at the 2004 Atlanta Games Day Golden Demon Painting Competition.

an enemy. For the next, he can go with more speed or firepower.

A few specialized mobs fielded alongside a healthy number of Ork Boyz can add lots of punch to an army. Burna Boyz can field an extraordinary number of flame-throwing burnas, which can also be used as power weapons (no armor save!) in combat. Skarboyz are crusty veteran Orks who pack close combat attacks with extra strength, while Stormboyz use Jump Packs to close the gap with the foe more quickly. For heavy support, it is tough to beat the walking menace of Killer Kans or Dreadnoughts, but Big Gunz provide some wicked options, like the always-hitting Zzap guns or the far-reaching shells of a Lobba. Orks can be battlefield scavengers too, and troops like Lootas may make use of enemy heavy weapons and even Looted vehicles from other armies. Even a Basilisk or Land Raider can turn up in an Ork force.

With so many effective and fun-to-play choices, it won't be long before you are building up your own Ork Waaagh! (the Orky word for massive invasion).



Andrew Cromwell won the Slayer Sword at the 2004 Baltimore Games Day Golden Demon Painting Competition with his Ork Big Mek.



**Ork Battle Force Box
99120103004**

- 16 Ork Boyz
- 5 Ork Warbikes
- 1 Ork Warbuggy
- 1 Ork Wartrukk
- Battlefield Accessories



GETTING STARTED

The 48-page Ork rulebook (left) contains painting and modeling guides, background, and the full army list for the Orks. The 32-page Armageddon rulebook (right) contains army list variants for the Armageddon war.



**Codex:
Orks**
60030103002



**Codex:
Armageddon**
60030199001

HQ



**Warlord Ghazghkull
Thraka Box (1)**
99110103092



**GHAZGHKULL'S
TUSKS**
9947010309201



**GHAZGHKULL'S
JAW**
9947010309202



**GHAZGHKULL'S
STIKK BOMB CHUKKA**
9947010309206



**GHAZGHKULL'S
POWER CLAW**
9947010309208



**GHAZGHKULL'S
HEAD**
9947010309203



**GHAZGHKULL'S
BODY**
9947010309204



**GHAZGHKULL'S
BACK BANNER**
9947010309207



**GHAZGHKULL'S
KUSTOM SHOOTA**
9947010309209

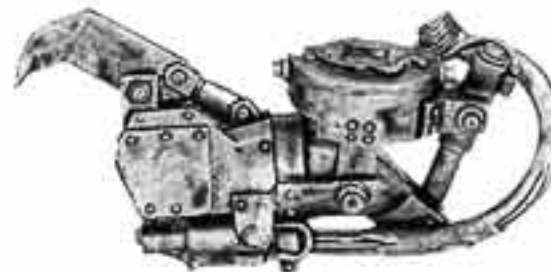

**GHAZGHKULL'S
POWER CLAW ARM**
9947010309210



**GHAZGHKULL'S
LEGS**
9947010309205



Nobz Mob Box (5)
99110103082

Nob Blister (Random 1)
99060103087



**NOB ICON
POLE 1**
9947010308213



**NOB ICON
POLE 2**
9947010308214



**NOB ICON
POLE 3**
9947010308215



**NOB
STANDARD
BOTTOM**
9947010308216



NOB HEAD 1
9947010308218



NOB HEAD 2
9947010308219



NOB HEAD 3
9947010308220



NOB HEAD 4
9947010308221



NOB HEAD 5
9947010308222



**NOB POWER
CLAW ARM**
9947010308210



**NOB CLAW
BOTTOM**
9947010308209



**NOB STANDARD
BACKPACK**
9947010308223



NOB BODY 1
9947010308201



NOB BODY 2
9947010308202



NOB BODY 3
9947010308203



NOB BODY 4
9947010308204



**NOB LEFT
CHOPPA ARM**
9947010308212



**NOB RIGHT
CHOPPA ARM**
9947010308208



**NOB LEFT
SLUGGA ARM**
9947010308206



**NOB RIGHT
SLUGGA ARM**
9947010308211



NOB BIG SHOOTA 1
9947010308205



NOB BIG SHOOTA 2
9947010308207



**ORK NOB
BACK BANNER**
9947040300408



**NOB STANDARD
TOP**
9947010308217



Warboss Blister (Random 1)
99060103079



ORK WARBOSS ATTACK SQUIG ARM
9947010309104

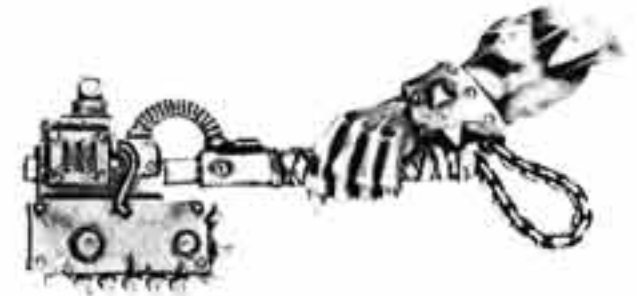

WARBOSS CHOPPA ARM
9947010307903



ORK WARBOSS SHOOTA/BURNA
9947010309103

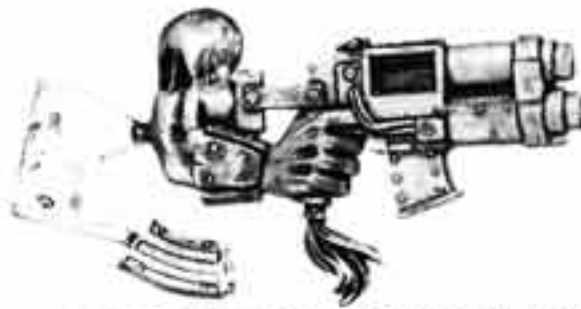

WARBOSS SHOOTA ARM W/ MAGAZINE
9947010307902



WARBOSS BODY 1
9947010307901



WARBOSS BODY 2
9947010309101



WARBOSS HEAD 1
9947010307904



WARBOSS HEAD 2
9947010309102



WARBOSS BACK BANNER
9947010307905



Mad Dok Grotsnik Blister (1)
99060103097



MAD DOK GROTSNIK BODY
9947010309701



MAD DOK GROTSNIK HEAD
9947010309702



MAD DOK GROTSNIK CLAW
9947010309704



MAD DOK GROTSNIK SHOOTA
9947010309703



MAD DOK GROTSNIK CLAW ARM
9947010309705



HQ



Nob in Mega Armor Blister (Random 1)
99060103078



MEGA ARMOR
HEAD SPRUE 1
9947010307803



MEGA ARMOR
HEAD SPRUE 2
9947010307804



MEGA ARMOR
HEAD SPRUE 3
9947010307805



MEGA ARMOR
JAW PLATE 1
9947010307807



MEGA ARMOR
JAW PLATE 2
9947010307808



MEGA ARMOR
JAW PLATE 3
9947010307806



MEGA ARMOR BODY 1
9947010307801



MEGA ARMOR BODY 2
9947010307802



NOB CLAW BOTTOM
9947010308209



MEGA ARMOR
POWER CLAW
9947010307813

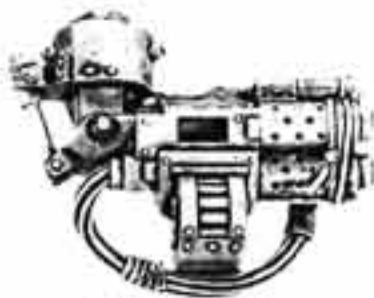

MEGA ARMOR
SHOOTA
9947010307809

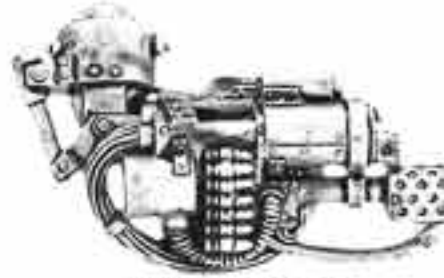

MEGA ARMOR
SHOOTA/SKORCHA COMBI
9947010307810

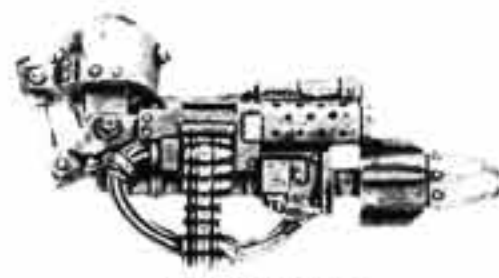

MEGA ARMOR
SHOOTA/ROKKIT COMBI
9947010307811

MEGA ARMOR
POWER CLAW BLADE
9947010307812

Occasionally, a Mekboy will exhibit the kind of ambition usually seen only among Nobz. Although he can never aspire to lead a whole warband, the Mekboy will gather other Mekboyz as followers and gain in power and stature.



MEKBOY RIGHT
ARM W/ SHOOTA
9947040300505



MEKBOY RIGHT
ARM W/ SLUGGA
9947040300506



MEKBOY
BACKPACK 1
9947040300503



Mekboy Blister (Random 1)
99060403005



MEKBOY W/
WRENCH BODY
9947040300501



MEKBOY W/
MALLET BODY
9947040300502



MEKBOY
BACKPACK 2
9947040300504



Stormboyz Mob Box (8)
99110103076

The Stormboyz Mob boxed set also includes the Ork Boyz Sprue (99380103001), shown with the Ork Boyz Mob boxed set.



STORMBOY ACCESSORY SPRUE
9947010307601



STORMBOY ROKKIT 1
9947010307602



STORMBOY ROKKIT 2
9947010307603



STORMBOY BODY
9947010307604



Stormboy Nob Blister (1)
99060103090



STORMBOY NOB BODY
9947010309001



STORMBOY NOB HEAD SPRUE
9947010309002



STORMBOY NOB JUMP PACK
9947010309003

The Stormboyz Nob blister also contains Nob Right Choppa Arm (9947010308208) and Nob Left Slugga Arm (9947010308206), both shown with the Ork Nobz.

ELITES

ORK FLESH

Even though all Orks are green, they don't all have to look the same! Below are some different ways to paint your greenskins.

Tip: Try mixing up different greens and browns and then add lighter shades to create your own skin tones.



BASECOAT: CATACHAN GREEN

For a basic Ork color, begin with Catachan Green and add Goblin Green to it for the first two highlights. Add some Rotting Flesh to the green mixture for the final highlight.



BASECOAT: DARK ANGELS GREEN

To create darker Orks, use Dark Angels Green and add Bad Moon Yellow for the highlights. For each highlight, simply increase the amount of Bad Moon Yellow that is added to the green.



BASECOAT: 50% DARK ANGELS GREEN 50% BESTIAL BROWN

After the basecoat is mixed, add Camo Green for the first two highlights. For the final highlight, use straight Camo Green for a more defined look.



BASECOAT: 50% SNOT GREEN 50% GRAVEYARD EARTH

This lighter green uses Rotting Flesh as the highlight ingredient. Add an increasing amount of Rotting Flesh to the Snot Green/Graveyard Earth mix for each of the highlights.



TROOPS



Ork Boyz Box (16)
99120103003

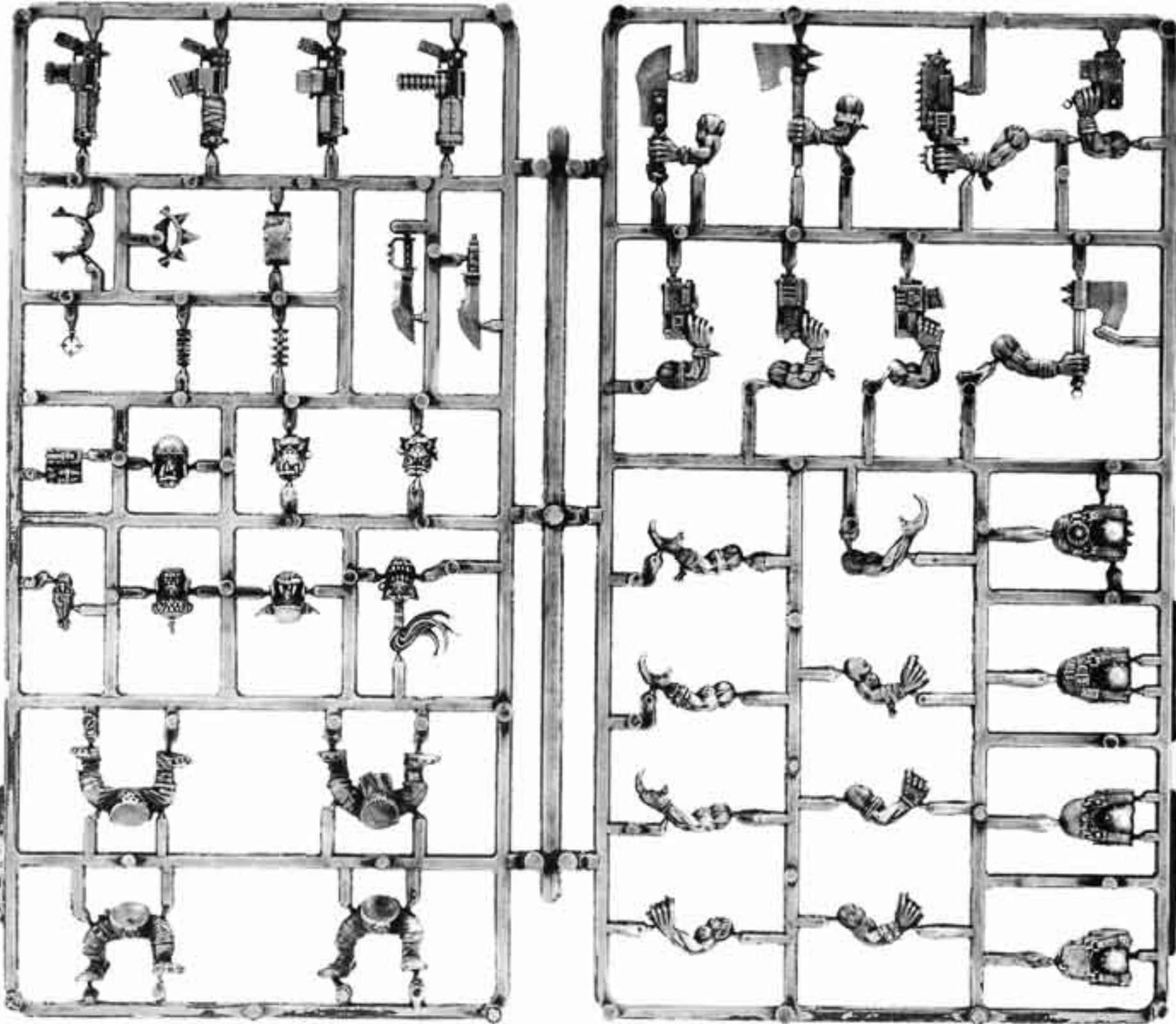

ORK BOYZ SPRUE (SHOWN 70% ACTUAL SIZE)
99380103001

You can assemble the Boyz in this boxed set with shootas (as shown above) or with sluggas and choppas (as shown below).



All miniatures are supplied unpainted. Models, bits, and sprues are all shown actual size unless otherwise noted. Contents may vary slightly from those shown.

TROOPS



SLAVER GRABBA STIKK
9947040301102



SLAVER WHIP
9947040301103



SLAVER BODY
9947040301101



Slaver Blister (1)
99060403011



GROT 1
9947040301201



GROT 2
9947040301202



GROT 3
9947040301203



**GROT W/
BLUNDERBUSS 1**
9947040302801



**GROT W/
BLUNDERBUSS 2**
9947040302802



GROT 4
9947040301204



GROT 5
9947040301205



GROT 6
9947040301206



**GROT W/
SLUGGA & KNIFE**
9947040302803



**GROT W/ 2 SIX
SHOOTAS**
9947040302804

Grots Blister (Random 4)
99060403028



Tankbusta Boyz Blister (2)
99060103093



TANKBUSTA BODY 1
9947010309301



TANKBUSTA BODY 2
9947010309303



TANKBUSTA ARM 1
9947010309302



**TANKBUSTA
ARM 2**
9947010309304



TROOPS

ORK SCRAP PILE



Start by cutting out a base from hardboard and sanding the edges down. Create a hill shape out of insulation foam and glue it in place on top of the hardboard.

Cover the base with white glue and sand. This layer will protect the foam from the super glue and spray primer.

Take bits and pieces from various models and glue them into place with super glue. Stack them to look random and disorganized. Make multiple layers of bits to create a disheveled look.



Once the scrap pile is built, prime it with black spray primer and then paint it with slightly watered-down Bestial Brown paint. Add some areas of Scab Red throughout the pile. Drybrush with Boltgun Metal and use Chestnut Ink to "stain" random areas. Finish up by gluing static grass to the base.



Boyz w/ 'Eavy Weapons Blister (Random 2)
99060103088



'EAVY BOY LEGS 1
9947010308803



'EAVY BOY LEGS 2
9947010308804



'EAVY BOY 'EAVY SHOOTA TORSO
9947010308801



'EAVY BOY ROKKIT LAUNCHA TORSO
9947010308802



'EAVY BOY HEAD 1
9947010308805



'EAVY BOY HEAD 2
9947010308806



'EAVY BOY HEAD 3
9947010308807



'EAVY BOY HEAD 4
9947010308808



Burna Boyz Blister (Random 2)
99060103083



BURNA BOY BODY 1
9947010308301



BURNA BOY BODY 2
9947010308302



BURNA BOY HEAD 1
9947010308303



BURNA BOY HEAD 2
9947010308304



BURNA BOY HEAD 3
9947010308305



BURNA BOY HEAD 4
9947010308306

All miniatures are supplied unpainted. Models, bits, and sprues are all shown as they are unless otherwise noted. Contents may vary slightly from those shown.

TROOPS



Stikk Bommas Mob Box (12)
99110103080



STIKK BOMMAS SPRUE
9947010308005



STIKK BOMMAS ARM 1
9947010308001



STIKK BOMMAS ARM 2
9947010308002



STIKK BOMMAS ARM 3
9947010308003



STIKK BOMMAS ARM 4
9947010308004

The Stormboyz Mob boxed set also includes the Ork Boyz Sprue (99380103001), shown with the Ork Boyz Mob boxed set.

FAST ATTACK



Warbike Box (1)
99120103005

The Warbike comes with the Small Tire Sprue (99399999034), shown with the Wartrukk and the Ork Decal Sheet (99510103004) shown later.

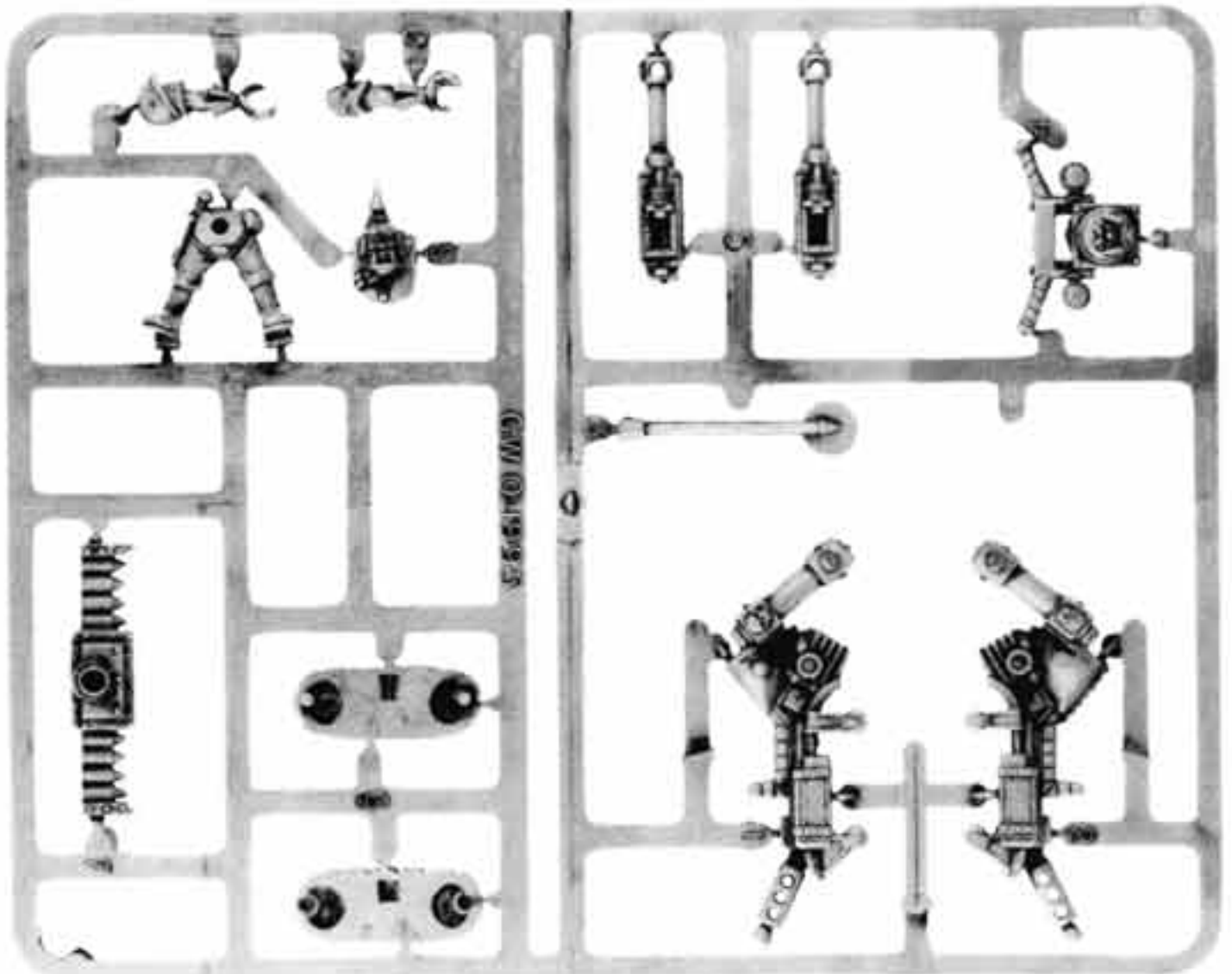

WARBIKE SPRUE (SHOWN 65% ACTUAL SIZE)
AVAILABLE ONLY IN WARBIKE BOX



FAST ATTACK

The Wartrak Skorcha comes with the Small Tire Sprue (99399999034), shown below, the Iron Wheel Sprue (99399999032), shown later, and the Ork Decal Sheet (99510103004) shown later.



SKORCHA CUPOLA
9947010303101

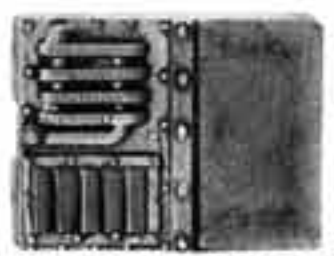

SKORCHA BASE PLATE
9947010303102



SKORCHA FLAMER
9947010303103



Wartrak Skorcha Box (1)
99140103001



SKORCHA GAUGES
9947010303109



SKORCHA TAPS & LEVERS SPRUE
9947010303107

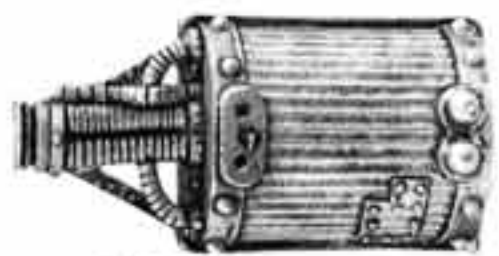

SKORCHA TANK TOP
9947010303104



SKORCHA TANK BOTTOM
9947010303105



SKORCHA TRAILER COUPLING
9947010303106



SKORCHA HATCH
9947010303108



SKORCHA SNOTLING PUMPER
9947010303110

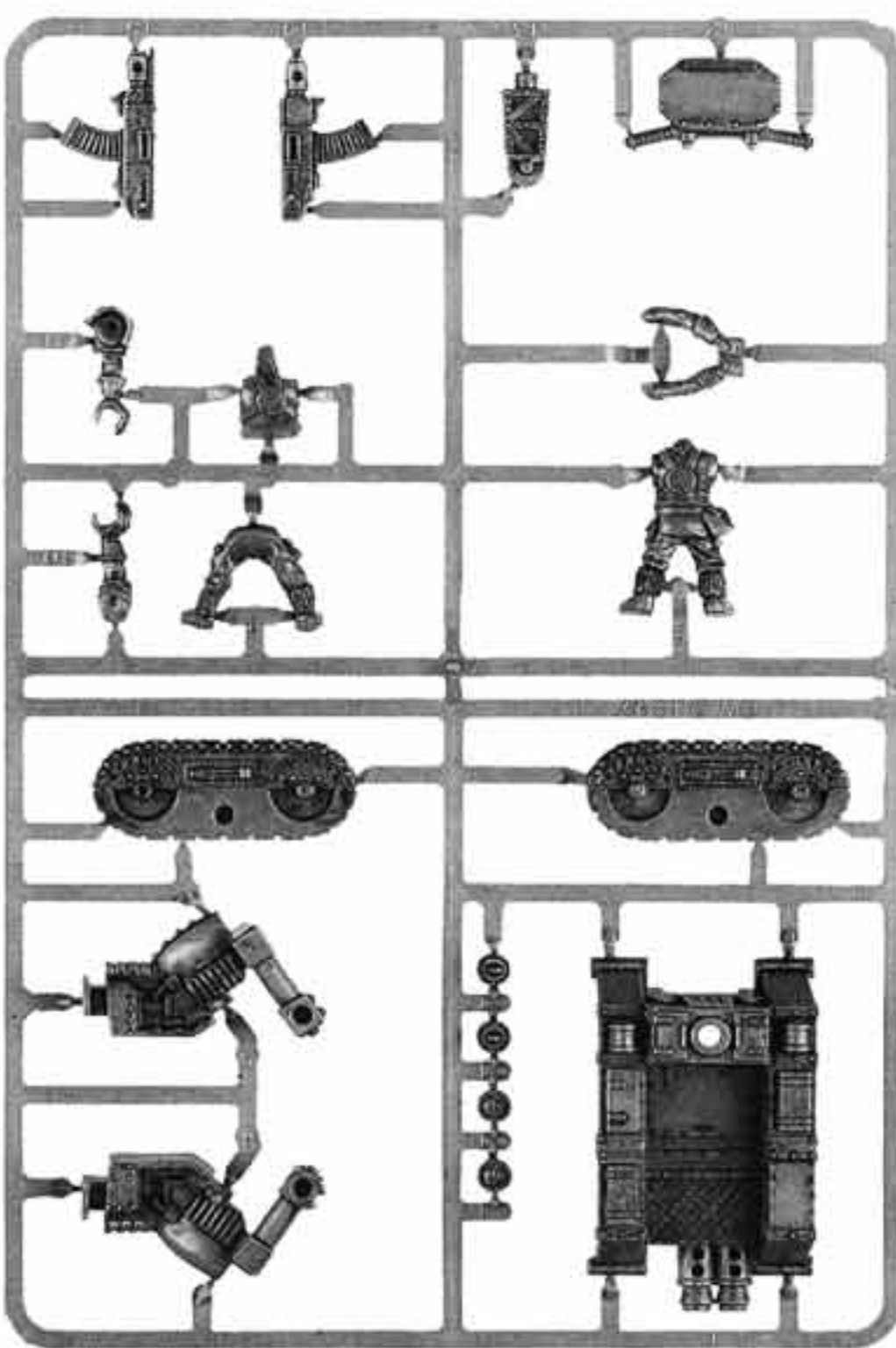

WARTRAK SPRUE (SHOWN 57% ACTUAL SIZE)
AVAILABLE ONLY IN WARTRAK BOX



The Wartrak comes with the Small Tire Sprue (99399999034), shown with the Wartrukk, and the Ork Decal Sheet (99510103004) shown later.



Wartrak Box (1)
99120103001





The Wartrukk comes with the Ork Decal Sheet (99510103004) shown later.

FAST ATTACK



Wartrukk Box (1)
99120103002

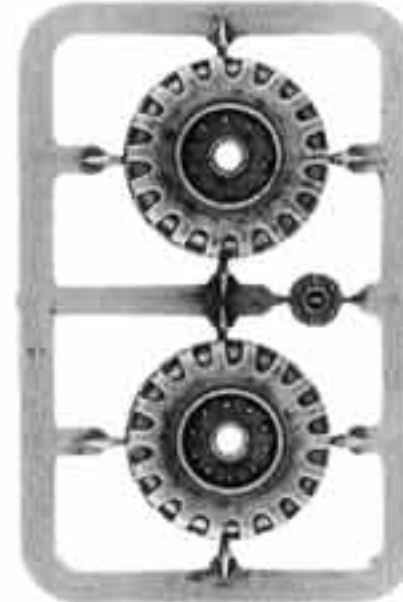

LARGE TIRE SPRUE
99399999033



SMALL TIRE SPRUE
99399999034

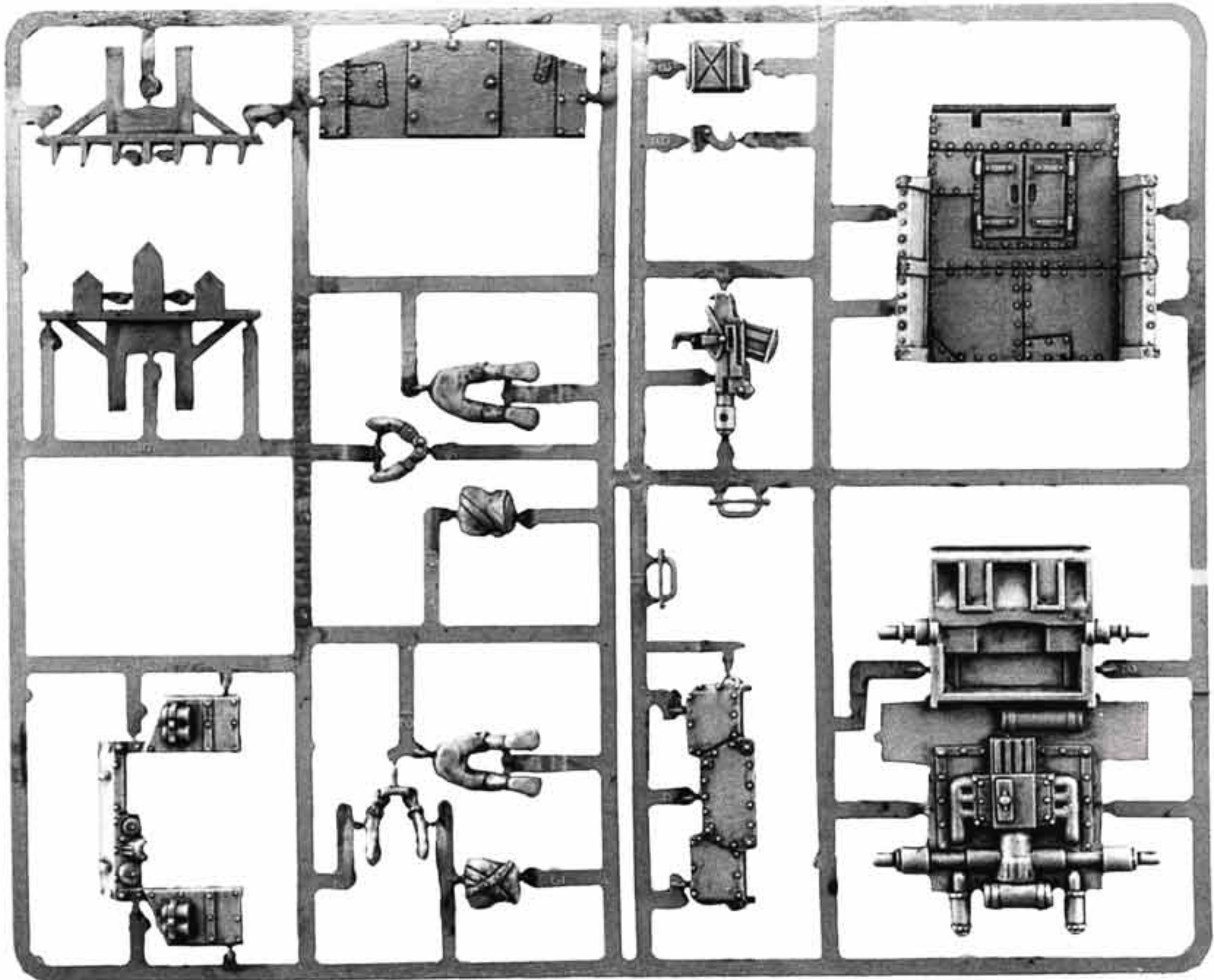

WARTRUKK SPRUE (SHOWN 75% ACTUAL SIZE)
AVAILABLE ONLY IN WARTRUKK BOX



FAST ATTACK



Warbuggy Box (1)
99120103006

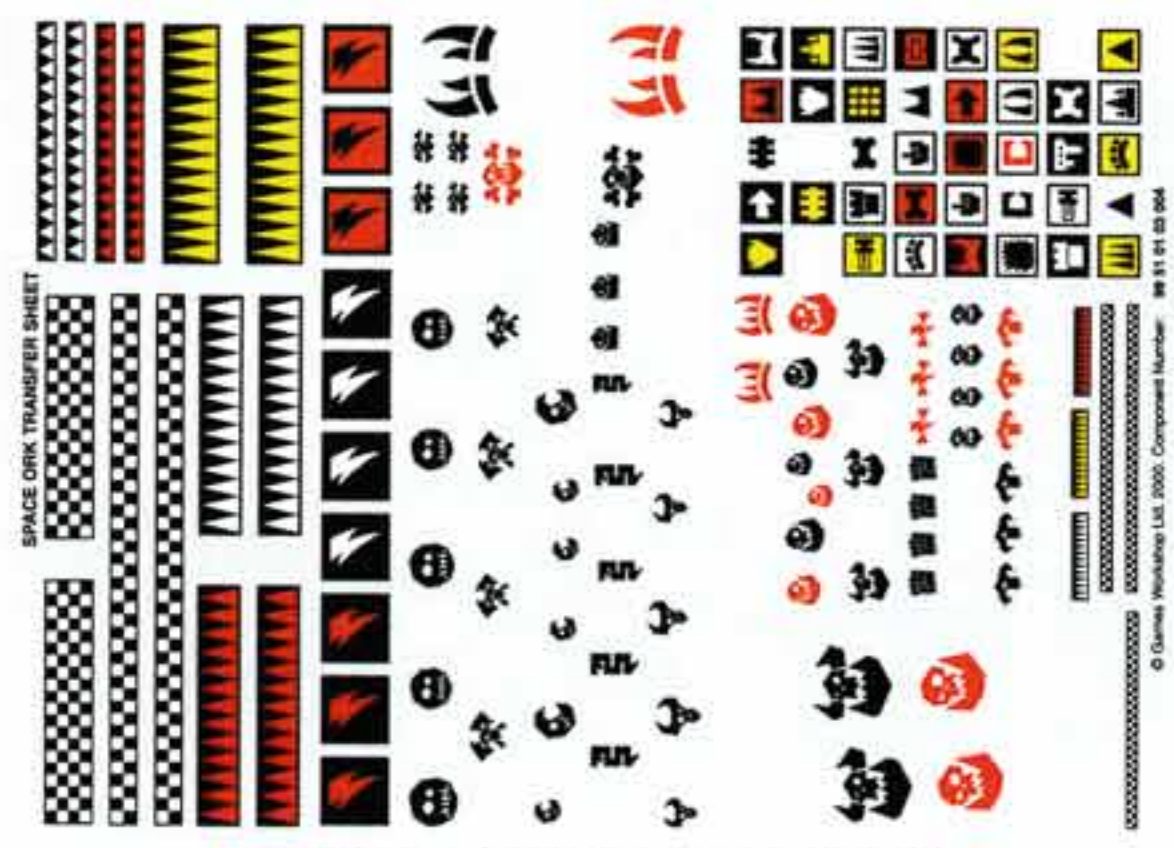

ORK DECAL SHEET (SHOWN 72% ACTUAL SIZE)
99510103004

The Warbuggy comes with the Large Tire Sprue (99399999033) and the Small Tire Sprue (99399999034), both shown with the Wartrukk.

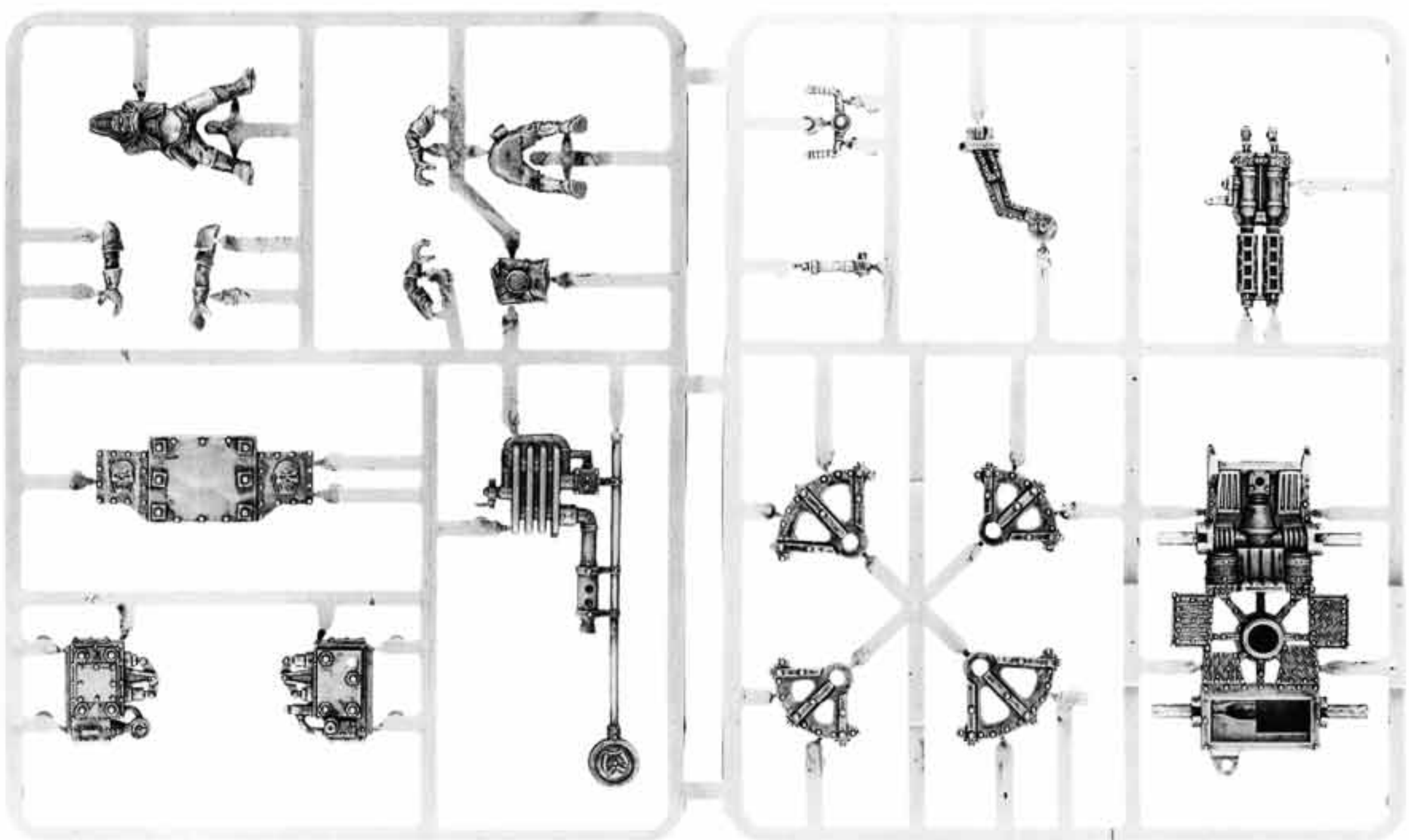

WARBUGGY SPRUES (SHOWN 70% ACTUAL SIZE)
AVAILABLE ONLY IN WARBUGGY BOX

All miniatures are supplied unpainted. Models, kits, and sprues are all shown actual size unless otherwise noted. Contents may vary slightly from those shown.

HEAVY SUPPORT

Each complete model on this page includes the two bits shown here.



ORK KANNON SPRUE
9947010309606

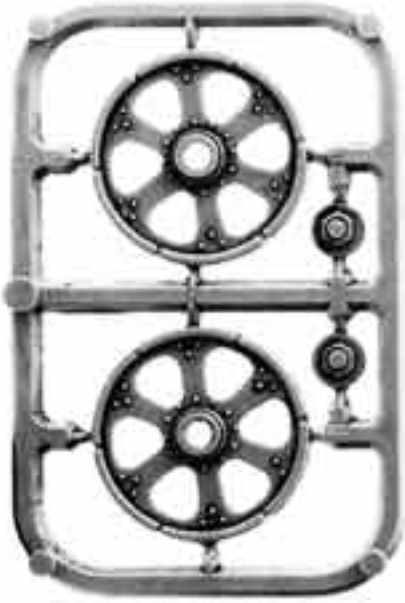

IRON WHEELS
99399999032



ORK ZZAP GUN
9947010309503



ORK ZZAP GUN FIRER
9947010309502

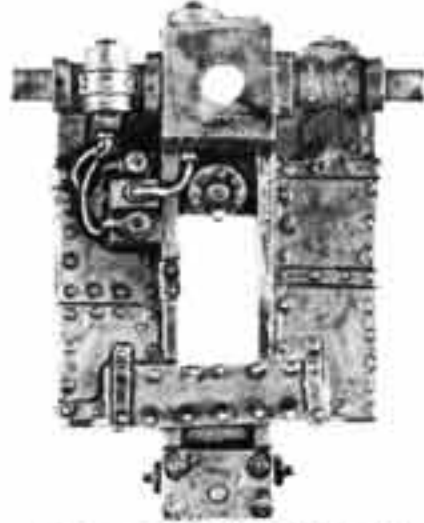

ORK ZZAP GUN CHASSIS
9947010309504



ORK ZZAP GUN SPOTTER
9947010309501



Zzap Gun Blister
(1 Zzap Gun and 2 Crew)
99060103095



Kannon Blister
(1 Kannon and 2 Crew)
99060103096



ORK KANNON LOADER
9947010309601



ORK KANNON FIRER
9947010309602



ORK KANNON SHIELD
9947010309605

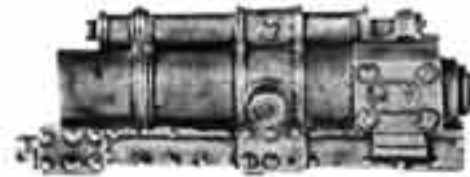

ORK KANNON BARREL
9947010309603



ORK KANNON CHASSIS
9947010309604



ORK LOBBA CHASSIS
9947010309404



ORK LOBBA MOUNT
9947010309405



ORK LOBBA HATCH
9947010309406



ORK LOBBA BARREL
9947010309403



ORK LOBBA FIRER
9947010309402



ORK LOBBA SPOTTA
9947010309401



Lobba Blister
(1 Lobba and 2 Crew)
99060103094



HEAVY SUPPORT

ORKY VEHICLE AND WEAPON DETAILS

CHECKS

To create checks, start by painting two straight lines with a fine detail brush and thinned



Chaos Black paint. Paint another line in the center of them to create three evenly spaced lines.



Make a grid by carefully painting lines that are perpendicular to the original three.



For the checkered effect, paint alternate squares Skull White.



Fill in the rest of the squares with Chaos Black.

DAGS



Begin by painting two parallel lines with thinned Chaos Black. Paint a zig-zag pattern in between these lines.



Carefully fill in one set of triangles with a color of your choice (we used Sunburst Yellow).



Finish by filling in the rest of the triangles with a different color (we chose Skull White).

GLYPHS

Choose a glyph and paint it onto a model with thinned Chaos Black paint. Remember, Orks aren't the best artists, so it's okay if the glyph is a little sloppy.



Fill in the area with another color, but leave the edges black. Here we used Codex Grey, but a darker shade of your army color would work well too!



Using a lighter color, start from the top (the teeth points) and paint streaks downward (toward the base of the teeth). We used Skull White.

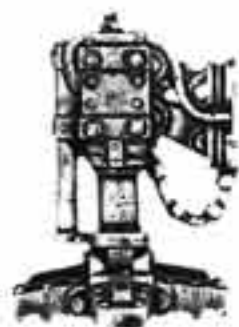

KILLER KAN LEG
9947010308408

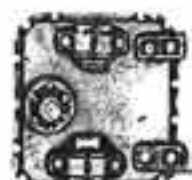

KILLER KAN TOP HATCH
9947010308409



KILLER KAN ARM 1
9947010308406



KILLER KAN ARM 2
9947010308407



KILLER KAN BITZ SPRUE
9947010308405



KILLER KAN BANNER POLE
9947010308410



KILLER KAN BACK
9947010308404

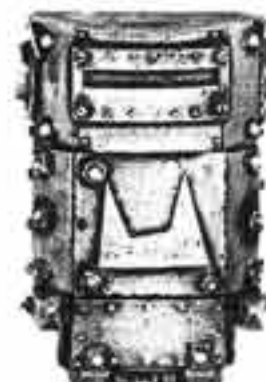

KILLER KAN FRONT 1
9947010308401

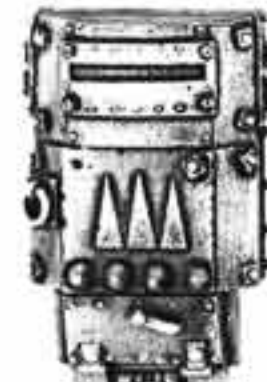

KILLER KAN FRONT 2
9947010308402

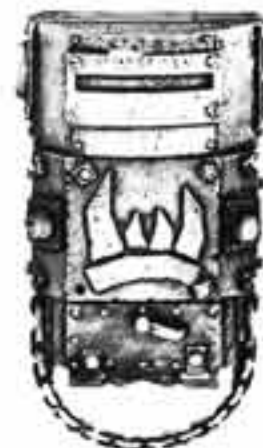

KILLER KAN FRONT 3
9947010308403



NOB ICON POLE 1
9947010308213



NOB ICON POLE 2
9947010308214



Killer Kan Blister (Random 1)
99060103084

The Killer Kan also includes the Skorcha (9947010307705), 'Eavy Shoota (9947010307703), Power Claw (9947010307707), Buzzsaw (9947010307708), and Rokkit Launcha (9947010307704) shown with the Ork Dreadnought, plus the Ork Decal Sheet (99510103004) shown earlier.



HEAVY SUPPORT



The Dreadnought also comes with the Ork Decal Sheet (99510103004) shown earlier.

Ork Dreadnought Box (1)
99110103077

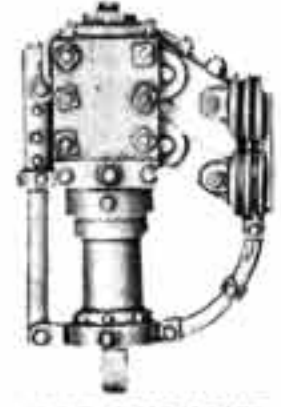

DREADNOUGHT LEG
9947010307711



DREADNOUGHT FOOT
9947010307712



DREADNOUGHT ARM 1
9947010307709



DREADNOUGHT ARM 2
9947010307710

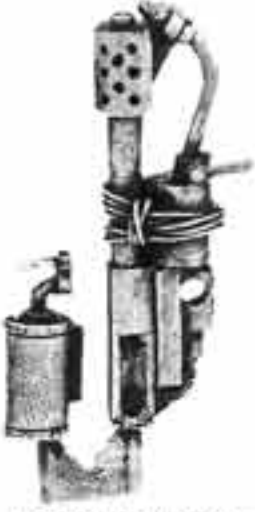

DREADNOUGHT SKORCHA
9947010307705

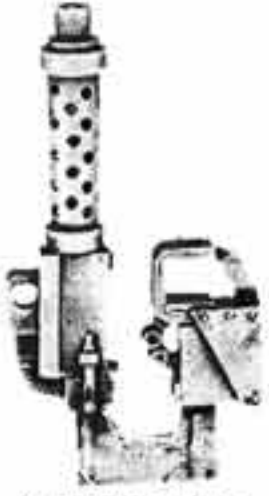

DREADNOUGHT 'EAVY SHOOTA
9947010307703



DREADNOUGHT ICON POLE
9947010307706



DREADNOUGHT POWER CLAW
9947010307707



DREADNOUGHT BUZZSAW
9947010307708

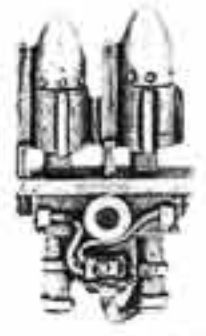

DREADNOUGHT ROKKIT LAUNCHA
9947010307704



DREADNOUGHT BOTTOM HATCH
9947010307715

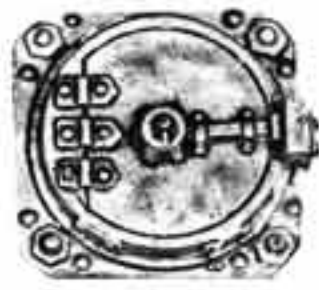

DREADNOUGHT TOP HATCH
9947010307716



DREADNOUGHT BITZ SPRUE 1
9947010307701

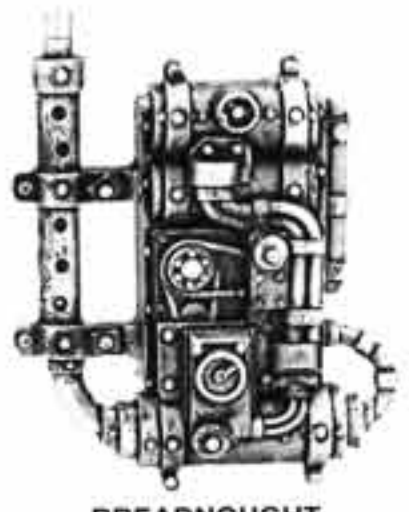

DREADNOUGHT POWER PLANT
9947010307717



DREADNOUGHT FRONT
9947010307713

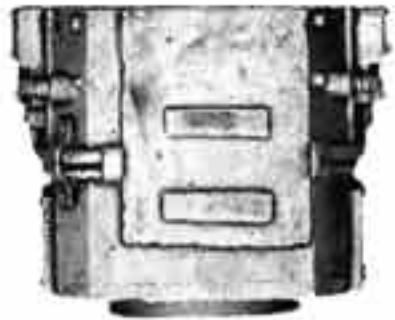

DREADNOUGHT BACK
9947010307714



DREADNOUGHT BITZ SPRUE 2
9947010307702

PAINTING RUSTY METAL

Many of the Ork models are equipped with metal weapons and have various metal bitz. Most Ork metal is rusty, since they obtain it from scrap piles and never take very good care of it. Here is an easy and fast way to paint metal with rusty spots all over it.

Start by priming the model black and apply a watered-down coat of Tin Bitz. Drybrush the model with Boltgun Metal and use heavier strokes in small, random patches (steps not shown).



Use Chestnut Ink for the basecoat of the rusty patches. Next, apply watered-down Bestial Brown over the Chestnut Ink patches.



Once dry, use undiluted Bestial Brown to strengthen the appearance of the rust. Finally, drybrush Vermin Brown over the rust spots for a finishing highlight.



COLORS OF WAR

KEY

■ Top Box(es): Basecoat Colors & Ink Washes

■ Bottom Box(es): Highlights

■ Mixed Colors



DEATHSKULLZ
Snot Green, Ultramarines Blue
Goblin Green, Ice Blue

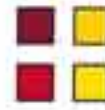

EVIL SUNZ
Red Gore, Golden Yellow
Blood Red, Sunburst Yellow



DEATHSKULLZ
Regal Blue, Ultramarines Blue
Ultramarines Blue & Ice Blue, Ice Blue

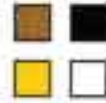

GOFFS
Dwarf Bronze, Chaos Black
Shining Gold, Skull White



GOFFS
Tin Bitz, Chaos Black
Chainmail, Skull White



BLOOD AXES
Snot Green, Chaos Black
Goblin Green, Chainmail



BAD MOONS
Boltgun Metal, Golden Yellow
Chainmail, Bad Moon Yellow



BAD MOONS
Boltgun Metal, Golden Yellow
Chainmail, Bad Moon Yellow



BLOOD AXES
Snakebite Leather, Codex Grey
Chaos Black, Fortress Grey

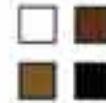

BLOOD AXES
Skull White, Bestial Brown
Snakebite Leather, Chaos Black



BLOOD AXES
Bubonic Brown, Vermin Brown
Chaos Black

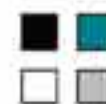

BLOOD AXES
Chaos Black, Hawk Turquoise
Skull White, Fortress Grey

TACTICS

TIPS FOR WINNING WITH ORKS



- A. The major advantages of an Ork army are numbers, mobility, and determination. Ork armies can field massive mobs and severely outnumber most other armies (Tyranids being a notable exception). Orks are also extremely mobile – the vast majority of their weaponry can be fired on the move, and the army includes both cheap transports and effective bikes. Orks also rarely fail Morale Checks – their Mob Size Check ability means that Orks will rarely ever run away. If you keep these factors in mind and play aggressively, your Ork army should be able to leverage these advantages into a real chance for victory. Try not to get too distracted by the shiny tanks, Dreadnoughts, and big gunz – you need plenty of Boyz to win!
- B. Orks normally aren't very resilient when faced with most ranged weapons. However, a few pieces of kit can produce a fairly resilient force of Orks. Mekboyz can carry kustom force fields to protect the Boyz on foot, and Warbikes can cruise along in the front lines to provide a cover save to all the units behind them. Add a big unit of Grots, and your Orks can withstand a great deal of shooting while they head toward the enemy!
- C. Most 40K players properly respect choppas and know that Orks excel in assault. You can pull out a nasty surprise, however, by fielding a full-size mob of Flash Gitz that has the more dakka upgrade and four big shootas. This unit can put out more than enough firepower to make up for the Orks' poor accuracy and can put a crimp in the plans of an opponent who was expecting your Orks to assault exclusively.



COUNTERTACTICS

TIPS FOR FIGHTING AGAINST ORKS

- A. One way to slow down an Ork army is to neutralize its advantages. To whittle down numbers, use template and blast weapons. To reduce the effects of the Mob Size Check, you can use many units who can affect enemy Leadership (such as Necron Pariahs, Culexus Assassins, and some psychic powers). To cut down on the Orks' mobility, destroy transports and put Warbikes on your priority list of targets.
- B. Although the kustom force field and the Warbikes do provide some protection, it is not enough to withstand concentrated fire. Focus on taking out the Warbikes and the mobs with the Mekboyz first, and you will find it much easier to deal with the rest of the army once they're gone. In addition, template weapons ignore cover saves. Armies that can field quite a few flamers (such as the Witch Hunters) can have a field day frying Orks regardless of kustom force fields or Warbike interference.
- C. The Flash Gitz can be a bit problematic, especially for armies with low armor saves like Tyranids or Imperial Guard. Although it may seem counterintuitive, this unit makes a good target for an assault. All those expensive guns will go to waste if they're tied up in close combat! Alternatively, consider driving a tank in front of these Orks to block off their line of sight to your other, more vulnerable units. The Flash Gitz will have a hard time taking out any vehicle with AV 12 or more.

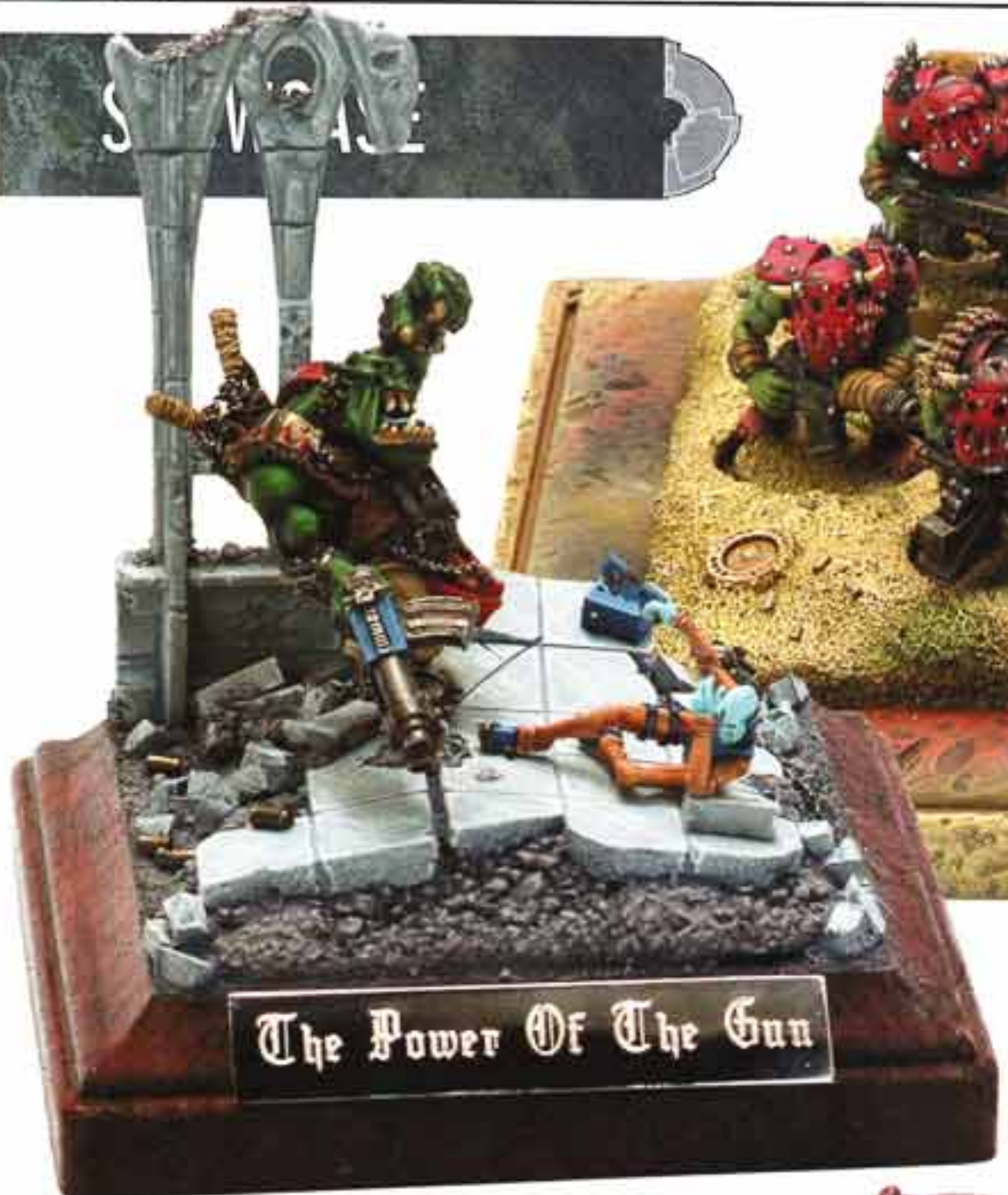

The Power Of The Gun

Below: Paul Carrick's Ork Guntrukk won first place at the 2004 Baltimore Games Day Golden Demon Painting Competition.

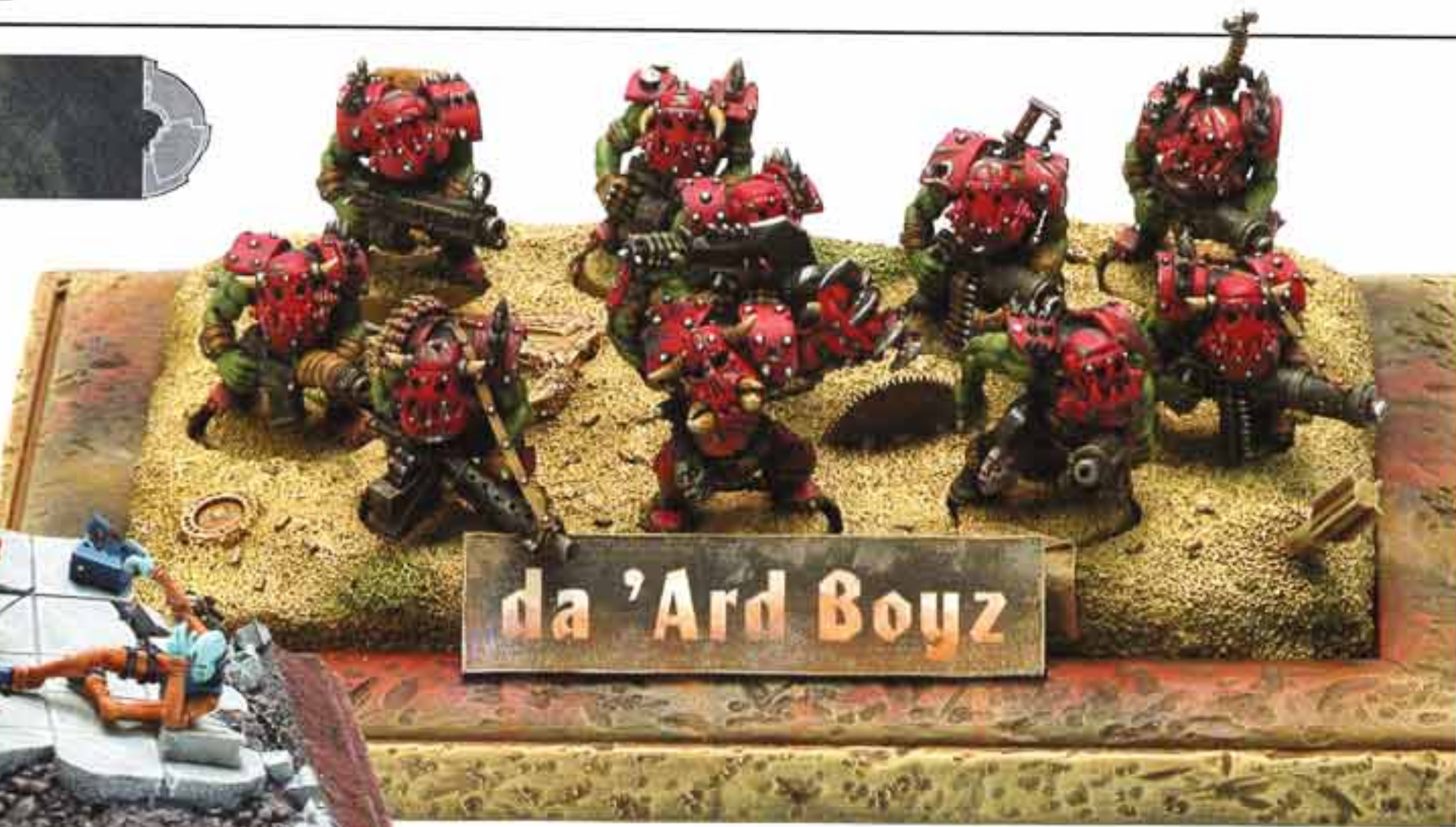

da 'Ard Boyz

Above: Paul Carrick's Da 'Ard Boyz was a runner up at the 2004 Baltimore Games Day Golden Demon Painting Competition.
Left: Raffi Parseghian's The Power of the Gun won third place at the 2004 LA Games Day Golden Demon Painting Competition.

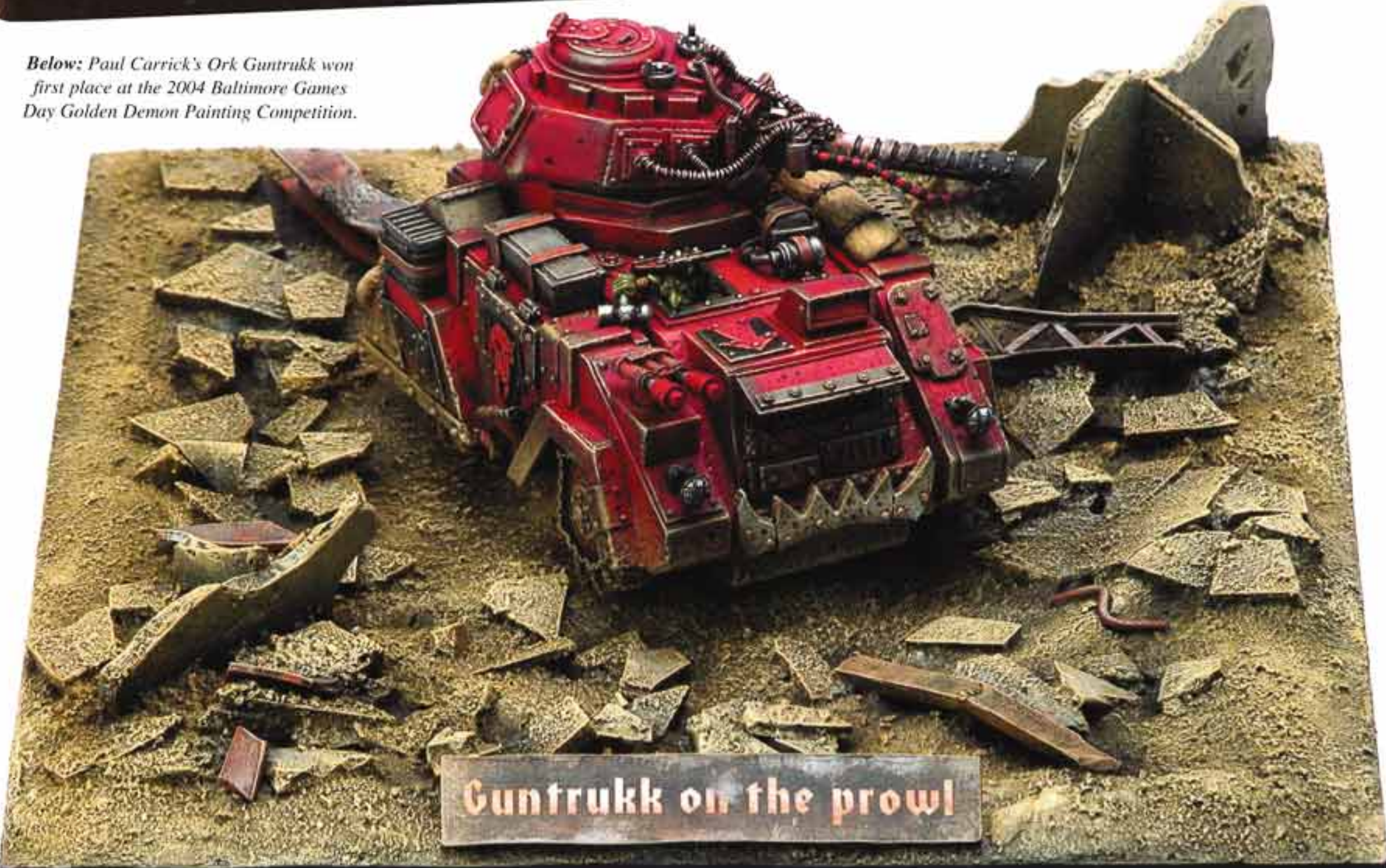

Guntrukk on the prowl

SHOWCASE



Above: Allan D. Carrasco won first place at the French 2004 Games Day Golden Demon Painting Competition with his Ork Boss.



Above: Dennis Mearsch won third place at the 2004 LA Games Day Golden Demon Painting Competition with his Killer Kan.

ALTERNATE MODEL – ELITES

'Ard Boyz

COMPONENTS FOR 4 COMPLETE MODELS

- 9947010308303 Burna Boy Head 1 (x2)
- 9947010308505 'Ard Boy Jaw Sprue (x2)
- 9947010308506 'Ard Boy Shoulder Sprue
- 9947020911501 Black Orc Body 1
- 9947020911502 Black Orc Body 2
- 9947020911503 Black Orc Body 3
- 9947020911504 Black Orc Body 4
- 9947040300802 Ork Gun Sprue

COMPLEXITY RATING



'ARD BOY JAW SPRUE
9947010308505



'ARD BOY SHOULDER SPRUE
9947010308506

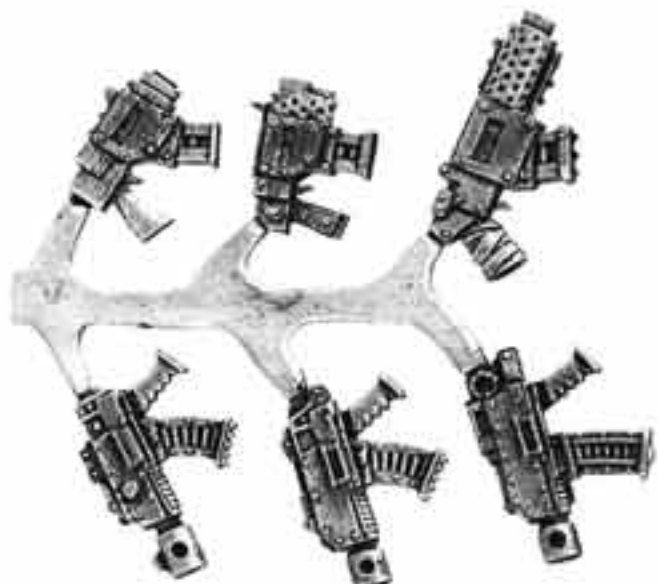

ORK GUN SPRUE
9947040300802



THIS CONVERSION CONTAINS THE SPECIAL OFFER BITZ SHOWN HERE
See the catalog introduction for more information.



ALTERNATE MODEL – TROOPS

Grots

COMPONENTS FOR 4 COMPLETE MODELS

- 99380209005 Goblin Sprue A
- 99380209006 Goblin Sprue B
- 9947040303103 Grot Weapon Sprue (x2)

COMPLEXITY RATING



THIS CONVERSION CONTAINS THE SPECIAL OFFER BITZ SHOWN HERE
See the catalog introduction for more information.

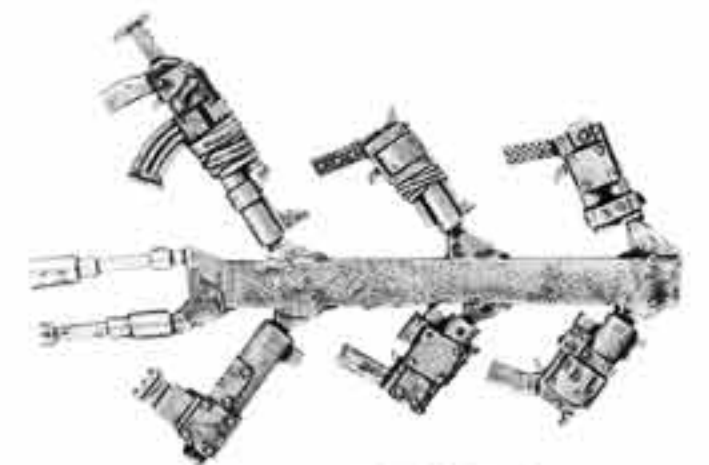

GROT WEAPON SPRUE
9947040303103

SPACE MARINES

Sergeant Peterson surveyed the rubble and carnage, took off his helmet, and scratched his head in amazement. For 3 days, the 3rd Imperial Guard Militia Regiment had been held up by rebel forces embedded in the trenches and thick cover of sector 317. Several assaults had been launched, all resulting in heavy casualties and a complete failure to penetrate enemy lines.

Just as the 3rd Regiment prepared for another seemingly hopeless attack, they were told by command to hold. Instead of the expected artillery barrage, two squads of Ultramarines arrived in their Rhino Transports. It was the first time Peterson had seen Space Marines, and the rumors all fell short of reality. In unspoken coordination, one squad supplied covering fire while the other squad advanced. In perfect order, the two squads advanced into the Rebel's most fortified positions. Enemy fire washed over the 7'-tall power-armored giants but bounced off like gentle rainfall. In a few moments, it was over. Just like that, the Space Marines remounted their vehicles and went off on further missions. As the grisly evidence at Peterson's feet proved, there were no rebel survivors.

Space Marines are genetically modified super soldiers that were first made in the dark and distant past by the Emperor himself. Equipped with power armor, extra organs, enhanced reflexes, superhuman strength, and more, the Space Marines are Humanity's finest warriors. Organized by Chapters, each of which has varying degrees of autonomy, Space Marines are deployed to the most deadly battle sites of the Imperium.

Fighting Style

A Space Marine army is capable of fulfilling any battlefield mission. By mixing squad selection, weapon choices, and equipment, a Space Marine force can defend, attack, stand back and shoot, rapidly advance, or any combination imaginable. Indeed, Space Marines are entrusted with all sorts of specialist missions such as raiding behind enemy lines, capturing vital positions, and defiant rearguard actions.

Some Space Marine Chapters are renowned for a particular battlefield trait or fighting style. The White Scars are famous for their hit-and-run style of attacks, while the Blood Angels are feared most for their close assault prowess. To find out more about famous Space Marine Chapters and their histories, look for Codex army books and the Index Astartes series.

Brother Captain Finnegan painted by Matt Verzani won third place at the 2004 Chicago Golden Demon painting competition.



Collecting a Space Marine Army

The best way to begin collecting an army is to get a few core Troops choices and a leader. These models will not only fulfill the compulsory selections from the Standard Missions template but will also give players a solid army core on which to build. Space Marines are an ideal army to build, whether you are a new Warhammer 40,000 player or an aged veteran of many battles. The army is compact and endlessly adaptable. Troops like Space Marine Tactical Squads can be upgraded with a few weapon options (like a lascannon to take out enemy armor or a heavy bolter to wipe out massed troops). You can also add a Transport in the form of a Rhino or Razorback. Likewise, a Space Marine Hero can take to the field of battle on his own (a great option for beginning armies) or can be accompanied by a Command Squad complete with Apothecary, Techmarine, and Standard Bearer.

When it comes to enlarging a Space Marine army, there are simply too many great choices. Players who favor bringing the attack to the enemy quickly can look to Fast Attack choices like Assault Squads (with jump packs), Bike Squadrons, or Land Speeders. Heavy Support comes in the form of heavy weapons upgrades (Devastator Squads) or a wide range of lethal support vehicles like a Predator Tank, Vindicator, Land Raider, or Whirlwind missile launcher. All Space Marines are fantastic, but their Elite selections are truly awesome. Dreadnoughts are great

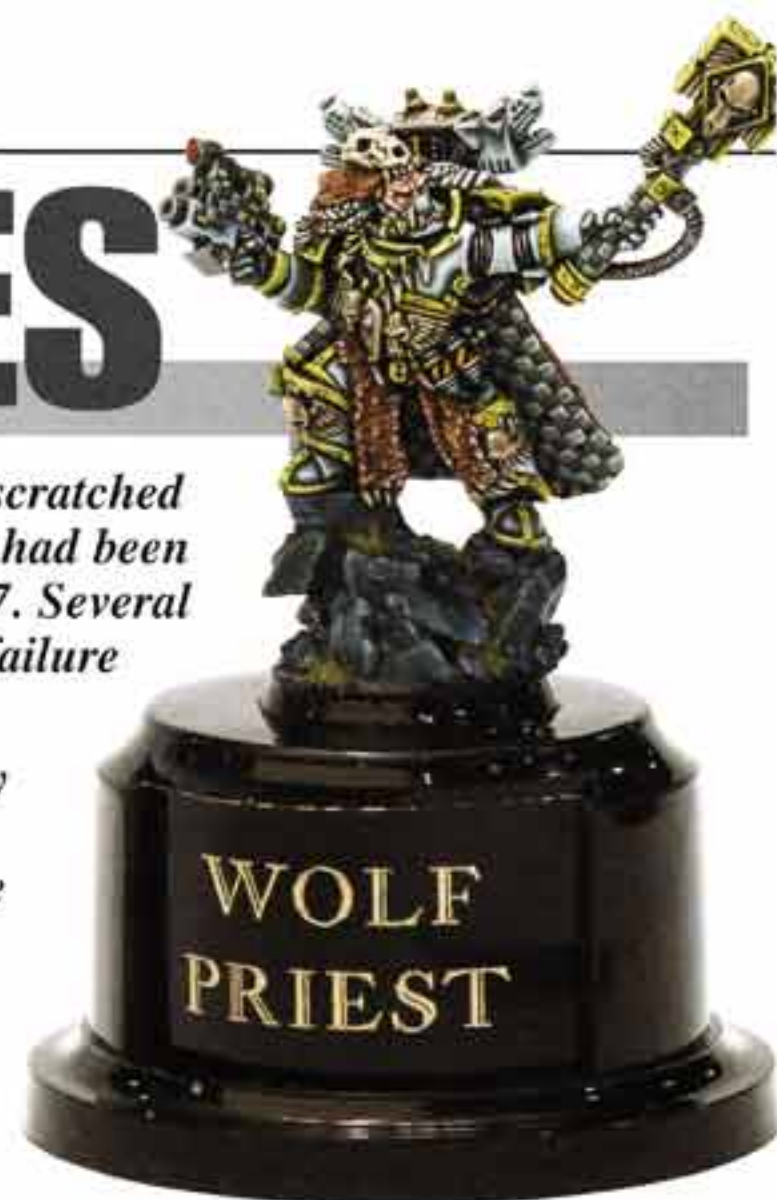

Ben Bishop's Wolf Priest won second place in the Warhammer 40,000 Single Miniature category at the 2004 Atlanta Golden Demon painting competition.

support for infantry, and Terminators are even more heavily armed and armored than standard Space Marines.

The Space Marine line of Citadel Miniatures is widely adaptable, with plenty of models and options usable by any Chapter (including ones you've made up yourself) as well as specific models to fulfill particular Chapter roles. Forward for the Emperor!

CHAPTER APPROVED!

Throughout this section, you'll find icons next to some products. They indicate that the model was designed to fit in with a specific Chapter. With a little conversion, however, any of these models can be used in any Space Marine army.



Joe Orteza's Iron-Father won second place in the Warhammer 40,000 Single Miniature category at the 2004 Chicago Golden Demon painting competition.



Codices

The Codex is the essential tome of knowledge and starting point for the Space Marine commander. There are specialized books for three Chapters – the Blood Angels, Dark Angels, and Space Wolves – and two on major events in the history of Warhammer 40,000.

GETTING STARTED



**Codex:
Space Marines**
60030101006



**Codex:
Blood Angels**
60030101003



**Codex:
Dark Angels**
60030101004



**Codex:
Space Wolves**
60030101005



**Codex:
Armageddon**
60030199001



**Codex:
Eye of Terror**
60030199007

Space Marines Megaforce 99120101019

- 1 Space Marine Commander
- 10 Tactical Marines

- 1 Command Squad
- 1 Combat Squad

- 1 Terminator Squad
- 1 Razorback



Space Marines Battle Force 99120101026

- 10-man Tactical Squad
- 5-man Assault Squad
- 3 Space Marine Bikes
- 1 Rhino
- 1 Set of Jungle Trees



Space Wolves Battle Force 99120101023

- 10-man Bloodclaws Squad
- 10-man Grey Hunters Squad
- 3 Space Wolves Bikes
- 1 Rhino
- 1 Set of Ruined Buildings





HQ



Space Marines Command Squad Box (5)
99120101028

The Space Marines Command Squad boxed set (99120101028) also includes the Space Marine Decal Sheet (99510101102) shown at the end of the Space Marines section.

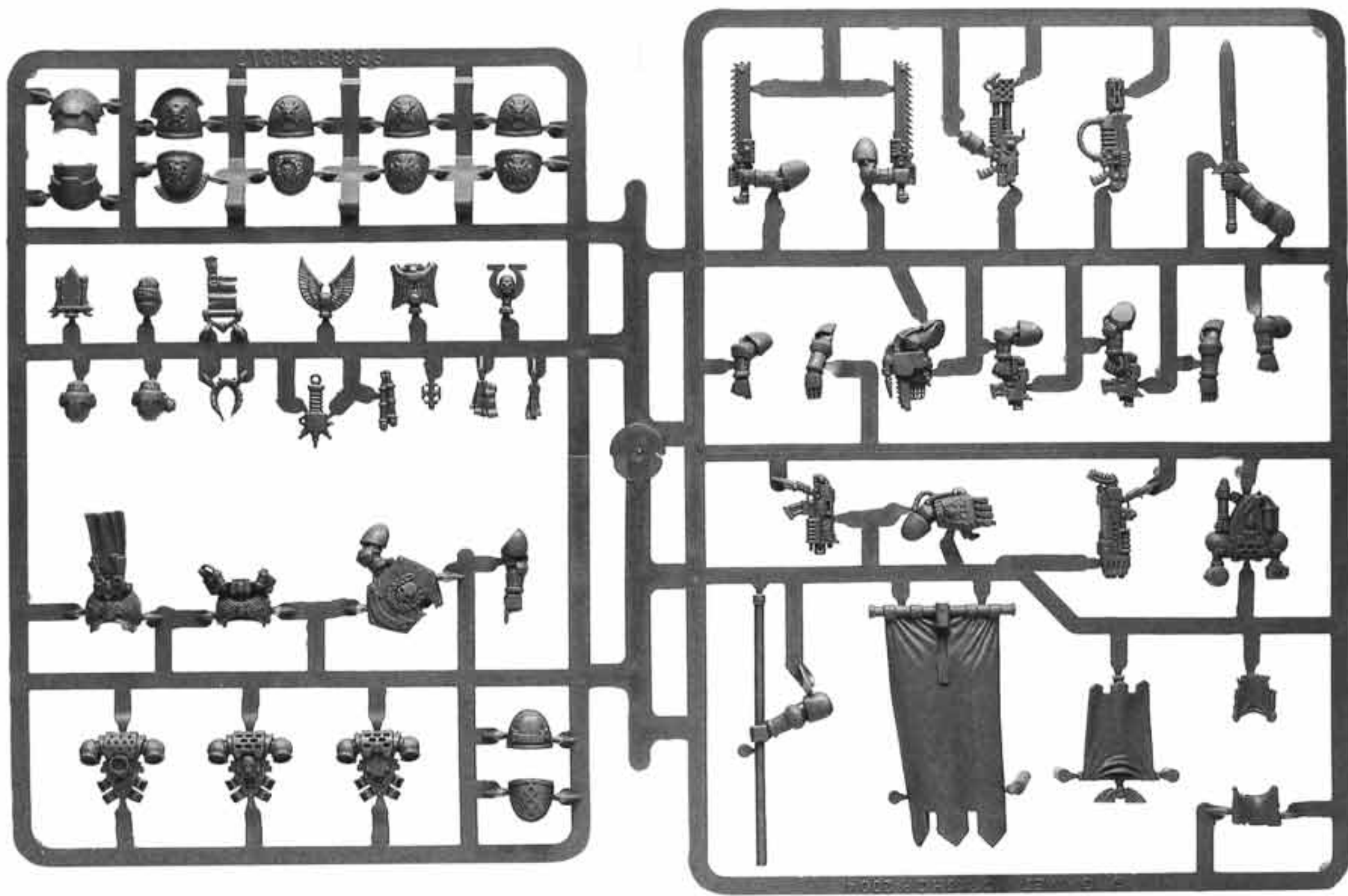

SPACE MARINE COMMAND SPRUE (SHOWN 75% ACTUAL SIZE)
99380101017



SPACE MARINE BACKPACK SPRUE
99380101004

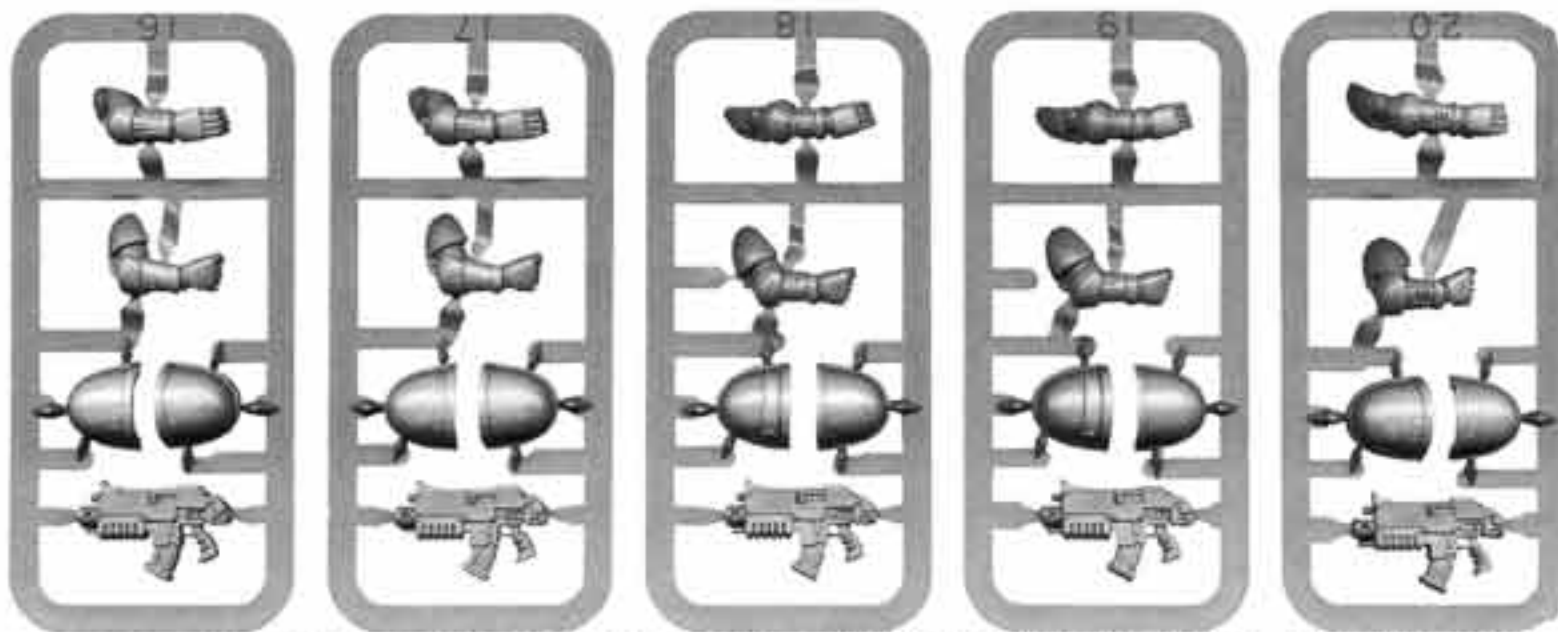

SPACE MARINE ARMS, BOLTERS & SHOULDER PADS SPRUE (SHOWN AT 75% ACTUAL SIZE) (RANDOM 1)
99380101005

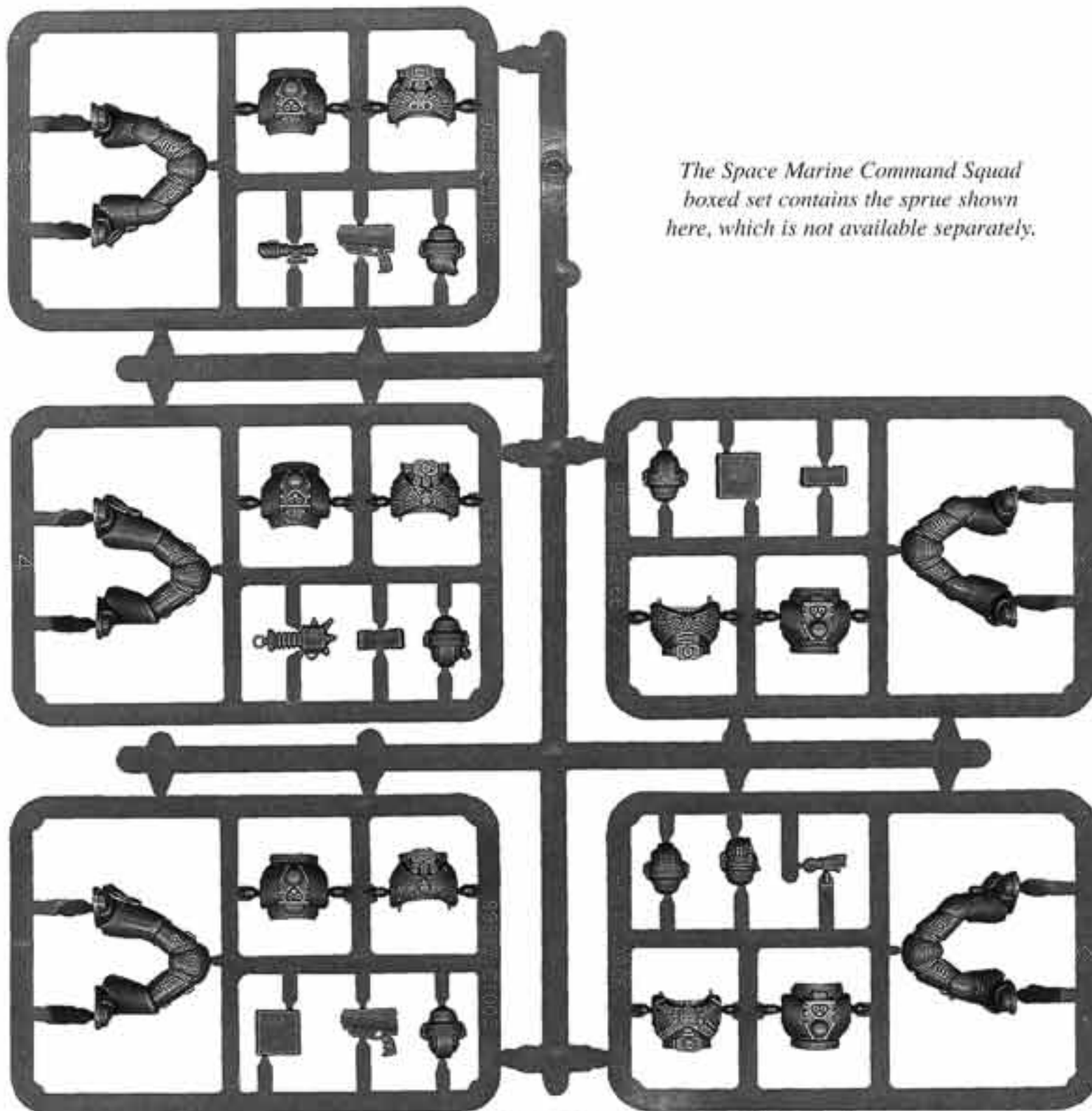

SPACE MARINE BODIES SPRUE (SHOWN 75% ACTUAL SIZE)
AVAILABLE ONLY IN BOXED SET

The Space Marine Command Squad boxed set contains the sprue shown here, which is not available separately.



SPACE MARINE BACK BANNERS

The back banners that Space Marines wear indicate in one visual stroke with which Chapter and squad they are associated and may tell of a storied incident from the Chapter's past. In any case, these banners really add impact to the look of your army.

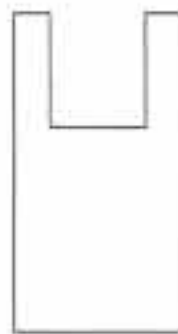

The new command sprue contains a plastic bit with a banner cast onto it. However, you may want to create a more personalized look for your officers by creating your own banners. Here are some helpful tips on how.

Start by drawing your design and outline on a piece of paper (or photocopy the template shown here and draw your design on it). Draw lightly so the design will be easy to cover with paint. Cut out your banner and attach it to a piece of plasticard or cardboard for stability.

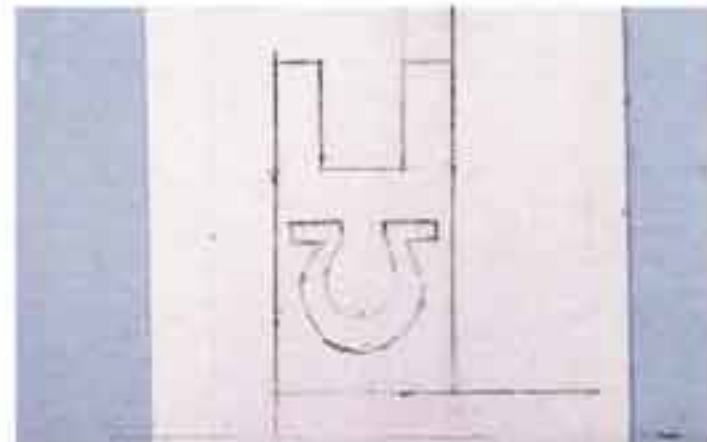

When you've painted the colors onto the banner, either paint the outline with a fine detail brush or trace it with a fine technical marker (pick one up at an art or craft store).

Carefully cut out your banner tabs first, paint the back a solid color, and attach it to the banner pole by folding the tabs over and using white glue to attach the tabs to the back of the banner. If you use a hobby knife (as in the picture) for precise attachment, be sure to use the flat side of the blade instead of the point. Be extra careful not to glue the banner to the banner pole itself.

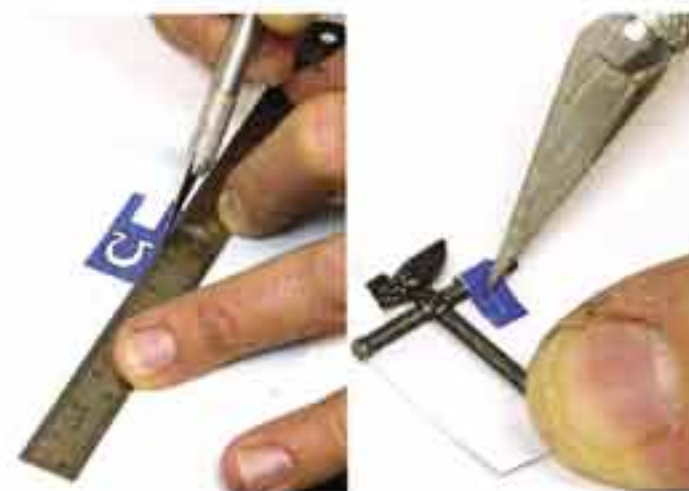

Once you finish one banner, the rest will only get easier. Remember, practice is the key. Try using brass rod to create larger banner poles so you can make larger and more ornate back banners for your army's special characters. Let your imagination go!



HQ

The Space Marine Commander boxed set (99120101032) contains enough parts to assemble one Space Marine Commander. Multiple examples are shown to illustrate the numerous accessories included on the sprue.



Space Marine Commander Box (1)
99120101032

The Space Marines Commander boxed set (99120101032) also includes the Space Marine Decal Sheet (99510101102) shown at the end of the Space Marines section.

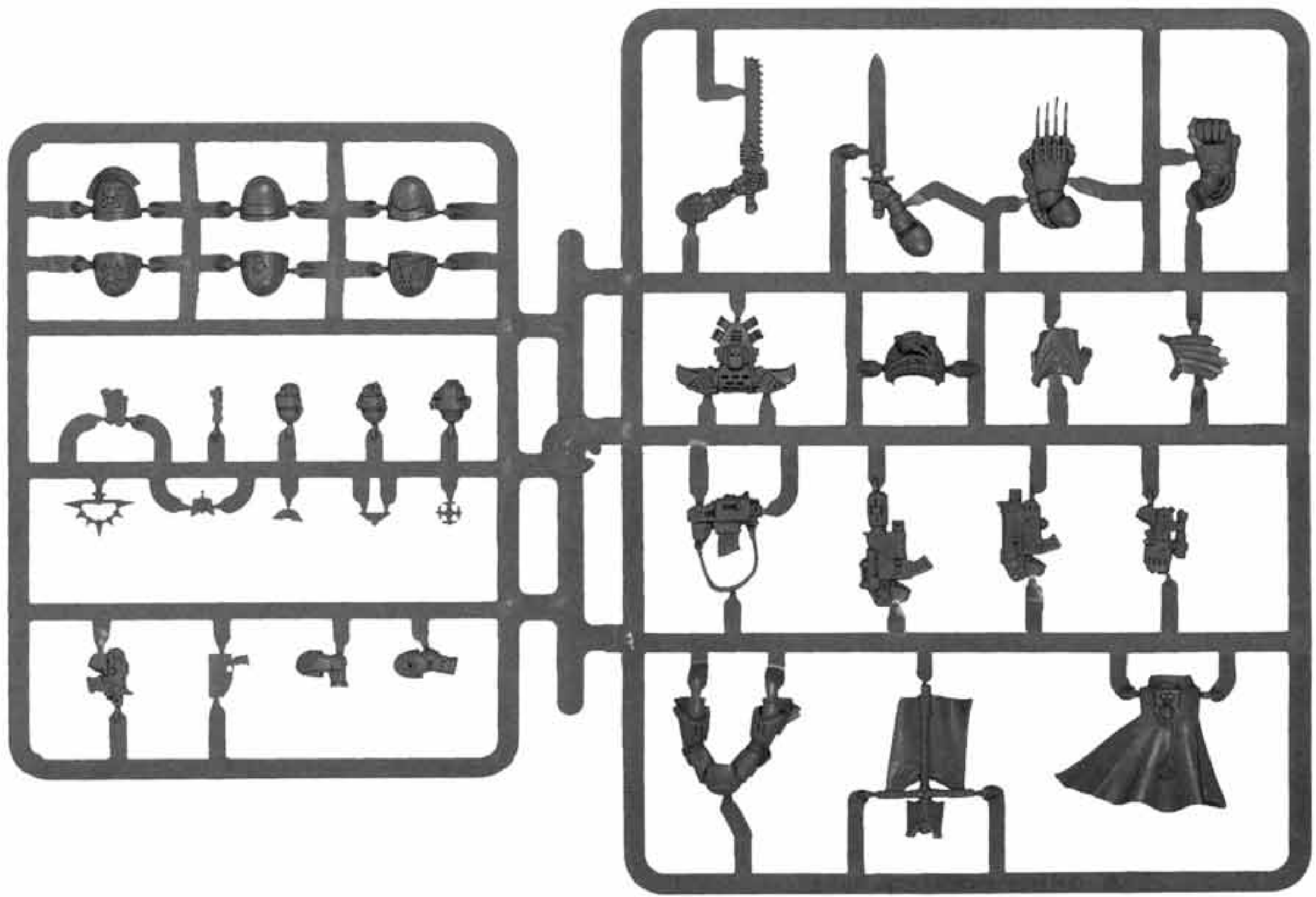

SPACE MARINE COMMANDER SPRUE
AVAILABLE ONLY IN BOXED SET

All Chaplains on this page can be equipped with a jump pack as shown with the Assault Marines in the Fast Attack section.

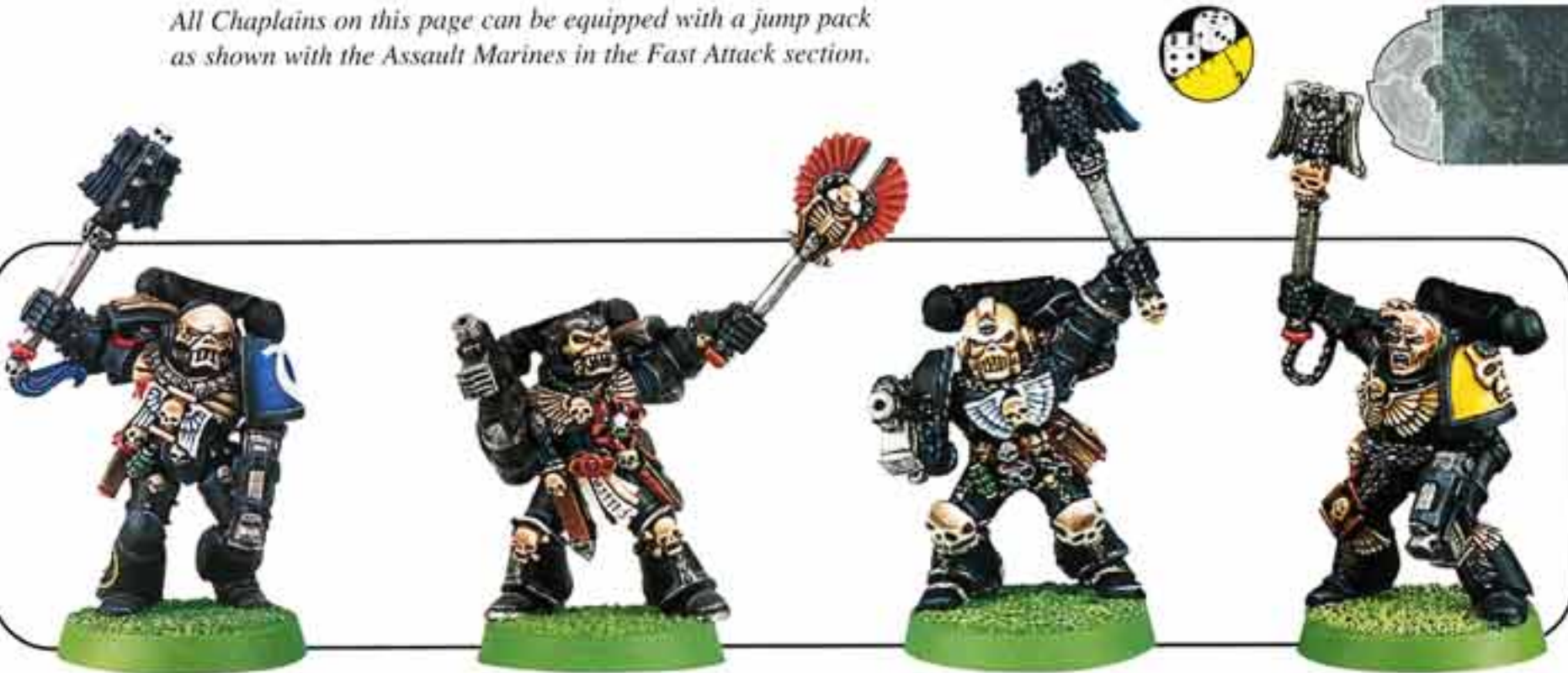

Space Marine Chaplain Blister (Random 1)
99060101031

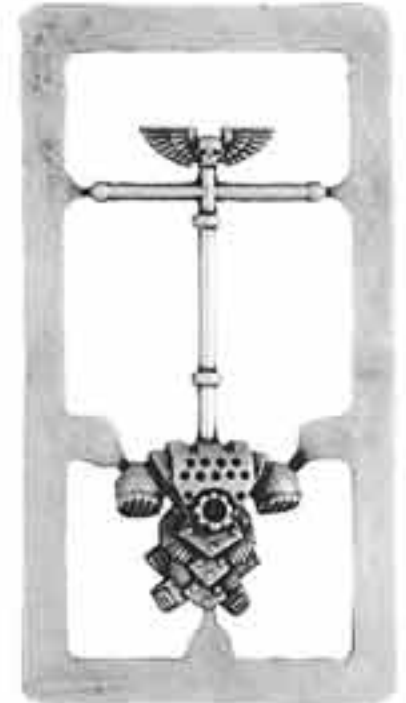

SPACE MARINE CHARACTER BACKPACK
99399999008



SPACE MARINE CHAPLAIN 1
9947010103103

SPACE MARINE CHAPLAIN 4
9947010103104

SPACE MARINE CHAPLAIN 2
ONLY AVAIL. IN BLISTER

SPACE MARINE CHAPLAIN 3
9947010103101



SPACE MARINE CHARACTER ARMS
99399999007

Space Marine Librarians come with the Space Marine backpack shown with Command Squad in the earlier in this section as well as the Space Marine Character Arms Sprue (99399999007) shown on this page. The bit codes listed here are for metal bodies with sculpted right arms.



EPISTOLARY LIBRARIAN 1
9947010101901

EPISTOLARY LIBRARIAN 2
9947010101902

LEXICANUM LIBRARIAN 1
9947010107001

LEXICANUM LIBRARIAN 2
9947010107002

CODICIER LIBRARIAN 2
9947010107301

CODICIER LIBRARIAN 1
9947010107302

Space Marine Librarian Blister (Random 1)
99060101174

HQ

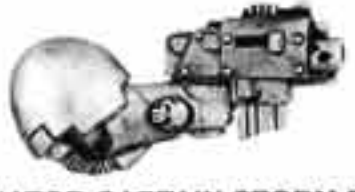

TERMINATOR CAPTAIN STORM BOLTER
994701011103



SPACE MARINE BANNER TOP
9947010101802



TERMINATOR CAPTAIN BODY
9947010111101



Terminator Captain Blister (1)
99060101111



TERMINATOR CAPTAIN BANNER POLE
9947010111104



TERMINATOR CAPTAIN POWER SWORD
9947010111102



Terminator Librarian Blister (1)
99060101041



TERMINATOR LIBRARIAN BODY
9947010104101



TERMINATOR LIBRARIAN FORCE AXE
9947010104102



TERMINATOR LIBRARIAN STORM BOLTER
9947010100704



TERMINATOR LIBRARIAN BANNER POLE
9947010104103



Terminator Chaplain Blister (1)
99060101040



TERMINATOR CHAPLAIN BODY
9947010104001



TERMINATOR CHAPLAIN CROZIUS
9947010104002



TERMINATOR CHAPLAIN STORM BOLTER
9947010100704



TERMINATOR CHAPLAIN BANNER POLE
9947010104003



This model and its bits are available only via special offer.

The Space Marine Apothecary blister comes with the Space Marine Character Arms sprue (99399999007) shown in the Space Marine HQ section.



Space Marine Apothecary Blister (Random 1)
99060101072



APOTHECARY 1
9947010107201



APOTHECARY 2
9947010107202



APOTHECARY MEDI-PACK
9947010107203



HONOR GUARD STANDARD ARM
9947010117708

Blood Angels Honor Guard Box (5)
99110101176

The Blood Angels Honor Guard also contains the Left and Right Assault Arm Sprues (99380101008 & 99380101009), and Jump Pack Sprue (99380101011) shown in the Fast Attack Section, as well as the Space Marine Decal Sheet (99510101102) shown at the end of the Space Marines section.



HONOR GUARD BANNER POLE
9947010117707



HONOR GUARD VET SERGEANT SPRUE
9947010117701



HONOR GUARD TECHMARINE TORSO
9947010117702



HONOR GUARD TECHMARINE POWER AXE
9947010117703



SANGUINARY PRIEST EXSANGUINATOR
9947010117706



SPACE MARINE PLASMA GUN
9947010117704



SANGUINARY PRIEST BODY
9947010117705



Blood Angels Death Company Squad Box (5)
99110101159

The Blood Angel Death Company boxed set comes with a Space Marine Backpack Sprue (99380101004) shown with the Space Marines Tactical Squad in the Troops section as well as the Left and Right Assault Arm Sprues (99380101008 & 99380101009) shown with the Space Marines Assault Squad in the Fast Attack Section.

This box also includes an assortment of Death Company shoulder pads, shown at the end of the Space Marines section.



The Blood Angels Death Company Space Marines Blister is available only via special offer.

Blood Angels Death Company Marines Blister (Random 2)
99060101164



DEATH COMPANY BODY 1
9947010115901



DEATH COMPANY BODY 2
9947010115902



DEATH COMPANY BODY 3
9947010115903



DEATH COMPANY BODY 4
9947010115904



DEATH COMPANY BODY 5
9947010115905



DEATH COMPANY POWER SWORD ARM
9947010115906



HQ



THE LION
HELM BEARER
9947010102105



AZRAEL
COMBI-WEAPON
9947010102102



AZRAEL
BANNER TOP
9947010102104



AZRAEL BACK
BANNER
9947010102103



COMMANDER
AZRAEL BODY
9947010102101



Azrael, Dark Angels Grand Master Blister (1)
99060101021



Logan Grimnar, Wolf Lord Blister (1)
99060101208



LOGAN GRIMNAR
WOLF CLOAK
9947010120802



LOGAN
GRIMNAR BODY
9947010120801



LOGAN GRIMNAR AXE
HEAD & WOLF SKULL
9947010120804



LOGAN GRIMNAR
STORMBOLTER ARM
9947010120803



Ragnar Blackmane,
Wolf Lord Blister (1)
99060101063



SPACE WOLF
BACKPACK
9947010106303



RAGNAR
BLACKMANE BODY
9947010106301



*This bit is available
only via special offer.*



SPACE WOLF
BACK BANNER 1
9947010106302



This model and its bitz are available only via special offer.

The Dark Angels Master of the Ravenwing also contains the Space Marine Land Speeder Sprue (99390101001) shown in Fast Attack.



Dark Angels Master of the Ravenwing Box (1)
99140101196



RAVENWING RIGHT ASSAULT CANNON
NOT AVAIL. SEPARATELY



RAVENWING LEFT ASSAULT CANNON
NOT AVAIL. SEPARATELY

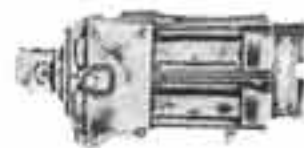

MASTER OF THE RAVENWING TWIN HEAVY BOLTER
NOT AVAIL. SEPARATELY



MASTER OF THE RAVENWING TORSO
9947010119601



MASTER OF THE RAVENWING SWORD ARM
9947010119602



MASTER OF THE RAVENWING SHOULDER PAD
9947010119603



MASTER OF THE RAVENWING SCANNER
NOT AVAIL. SEPARATELY



MASTER OF THE RAVENWING SCANNER MOUNT
NOT AVAIL. SEPARATELY



MASTER OF THE RAVENWING GUN MOUNT
NOT AVAIL. SEPARATELY



MASTER OF THE RAVENWING ANGEL
9947010119607



MASTER OF THE RAVENWING BOOK
9947010119606



Lysander, Captain of the Imperial Fists Blister (1)
99060101311



CAPTAIN LYSANDER BODY
9947010131101



CAPTAIN LYSANDER ARM SPRUE
9947010131102



CAPTAIN LYSANDER SHIELD SPRUE
9947010131103





HQ



**Ultramarines Chaplain
Cassius Blister (1)**
99060101302



**CHAPLAIN
CASSIUS BODY**
9947010130201



**CHAPLAIN
CASSIUS ICON**
9947010130203



**CHAPLAIN
CASSIUS BOLT
PISTOL ARM**
9947010130204



**Asmodai, Dark Angels
Chaplain Blister (1)**
99060101022



ASMODAI BODY
9947010102201



**ASMODAI POWER
SWORD ARM**
9947010102202



Death Company Chaplain Blister (1)
99060101160
BIT NAME: BLOOD ANGELS CHAPLAIN
BIT CODE: 9947010100101

The Blood Angel Death Company Chaplain comes with the Space Marine Character Backpack (99399999008) shown earlier in this section.



Ulrik the Slayer, Wolf Priest Blister (1)
99060101064
BIT NAME: ULRİK THE SLAYER BODY
BIT CODE: 9947010106401

Ulrik the Slayer Comes with the Space Wolf Backpack (9947010106303) shown earlier in this section.

All miniatures are supplied unpainted. Models, bits, and sprays are all shown actual size unless otherwise noted. Contents may vary slightly from those shown.



This model and its bitz are available only via special offer.



**Lemartes, Blood Angels
Chaplain Blister (1)**
99060101165



**CHAPLAIN
LEMARTES
BOLT PISTOL**
9947010116502



**CHAPLAIN
LEMARTES BODY**
9947010116501



These bitz are available only via special offer.



White Scars Commander
Only Available as Bitz



**Ezekiel, Dark Angels
Grand Master
Librarian Blister (1)**
99060101023



EZEKIEL BODY
NOT AVAIL. SEPARATELY



**EZEKIEL
FORCE SWORD**
9947010102302



WHITE SCARS COMMANDER
9947010123301



**WHITE SCARS COMMANDER
EQUIPMENT SPRUE**
9947010123302



**WHITE SCARS COMMANDER
EQUIPMENT BIKE FAIRING**
9947010123303





HQ



Emperor's Champion Blister (1)
99060101236



EMPEROR'S CHAMPION BODY
9947010123601



EMPEROR'S CHAMPION BODY
9947010123602



Space Wolf Rune Priest Blister (1)
99060101241



SPACE WOLF RUNE PRIEST
NOT AVAIL. SEPARATELY



RUNE PRIEST ACCESSORY SPRUE
9947010124102



Space Wolf Rune Priest Terminator Blister (1)
99060101148



RUNE PRIEST TERMINATOR BODY
NOT AVAIL. SEPARATELY



This model is available only via special offer as a complete model.



RUNE PRIEST TERMINATOR FORCE AXE
NOT AVAIL. SEPARATELY



WOLF GUARD STORM BOLTER ARM
9947010101405



Captain Tycho, Blood Angels Commander Blister (1)
99060101028

Captain Tycho is not available as a bit. He also comes with a Space Marine Character Backpack (99399999008).

HQ



**Commander Dante,
Lord of the Blood
Angels Blister (1)**
99060101027



**COMMANDER
DANTE'S BODY**
9947010102701



**COMMANDER DANTE'S
INFERNO PISTOL**
9947010102702



**COMMANDER
DANTE'S JUMP PACK**
9947010102703



**Corbulo, Blood
Angels Sanguinary
High Priest Blister (1)**
99060101025



**APOTHECARY
CORBULO BODY**
NOT AVAIL. SEPARATELY



**APOTHECARY
MEDI-PACK 1**
9947010107203



**Mephiston, Blood
Angels Chief
Librarian Blister (1)**
99060101026



MEPHISTON BODY
NOT AVAIL. SEPARATELY



**MEPHISTON
FORCE SWORD**
9947010102602





HQ



**Tigurius, Ultramarines
Chief Librarian Blister (1)**
99060101309



TIGURIUS BODY
9947010130901



TIGURIUS SPRUE
9947010130902



**Shrike, Captain of the
Raven Guard Blister (1)**
99060101310



**CAPTAIN SHRIKE
BODY**
9947010131001



**CAPTAIN SHRIKE
LIGHTNING CLAW**
9947010131002



**CAPTAIN SHRIKE
JUMP PACK**
9947010131003



**Dark Angel Standard
Bearer Blister (1)**
99060101024

*Dark Angel Standard
Bearer comes with a
Space Marine Backpack
(99380101004) and a
Space Marine
Character Arm Sprue
(99399999007).*



**DARK ANGELS
STANDARD BEARER TOP**
9947010102402



**DARK ANGEL
STANDARD BEARER**
NOT AVAIL. SEPARATELY

*Space Wolf Standard
Bearer comes with a
Space Marine Backpack
(99380101004) and a
Space Marine
Character Arm Sprue
(99399999007).*



**Space Wolf Standard
Bearer Blister (1)**
99060101132

**BIT NAME: SPACE WOLF
STANDARD BEARER**
BIT CODE: 9947010106502



Marneus Calgar with Honor Guard also comes with the Space Marines Backpack Sprue (99380101004) shown earlier in this section.

HQ



Marneus Calgar with Honor Guard Box (5)
99110101299



HONOR GUARD CHAMPION 1
9947010129908



HONOR GUARD CHAMPION 2
9947010129909



HONOR GUARD CHAMPION
9947010129906



HONOR GUARD CHAMPION SPRUE
9947010129907



CALGAR TORSO
9947010129901



HONOR GUARD WEAPON SPRUE
9947010129904



HONOR GUARD STANDARD BEARER BODY
9947010129910



CALGAR FIST SPRUE
9947010129903



CALGAR LEGS
9947010129902



CALGAR BASE
9947010129905



ELITES



Space Marine Veterans Box (5)
99110101300

The Space Marine Veterans boxed set (99110101300) also includes the Space Marine Backpack Sprue (99380101004) shown earlier in this section and the Space Marine Decal Sheet (99510101102) shown at the end of the Space Marines section.



VETERAN MARINE 5 (NO ARMS)
9947010130005



POWER ARMOR LIGHTNING CLAWS
9947010130028



VETERAN MARINE BANNER 2
9947010130021



VETERAN MARINE 6 W/ POWERFIST ARM
9947010130024



VETERAN MARINE 1 (CHAINSWORD)
9947010130026



VETERAN MARINE 2 (AXE & LAURELS)
9947010130025



VETERAN MARINE 7 W/ BOLT PISTOL ARM
9947010130027



All miniatures are supplied unpainted. Models, bits, and sprues are all shown actual size unless otherwise noted. Contents may vary slightly from those shown.



Space Marine Veteran Blister (Random 2)
99060101300

The Space Marine Veterans blister (99060101300) also includes two backpacks from the Space Marine Backpack Sprue (99380101004) shown earlier in this section.



VETERAN BOLT PISTOL ARM (RANDOM 1)
9947010130010



VETERAN MARINE BANNER (RANDOM 1)
9947010130013



VETERAN BOLTER ARM (RANDOM 1)
9947010130011



VETERAN MARINE 1 (CHAINSWORD)
9947010130003



VETERAN MARINE 2 (AXE & LAURELS)
9947010130004



VETERAN MARINE 4 (MACE)
9947010130007



VETERAN MARINE 3 (CHAINSWORD)
9947010130006



ELITES



Space Marine Terminators Box (5)
99120101027

The Space Marine Terminators boxed set (99120101027) also includes the Space Marine Decal Sheet (99510101102) shown at the end of the Space Marines section.

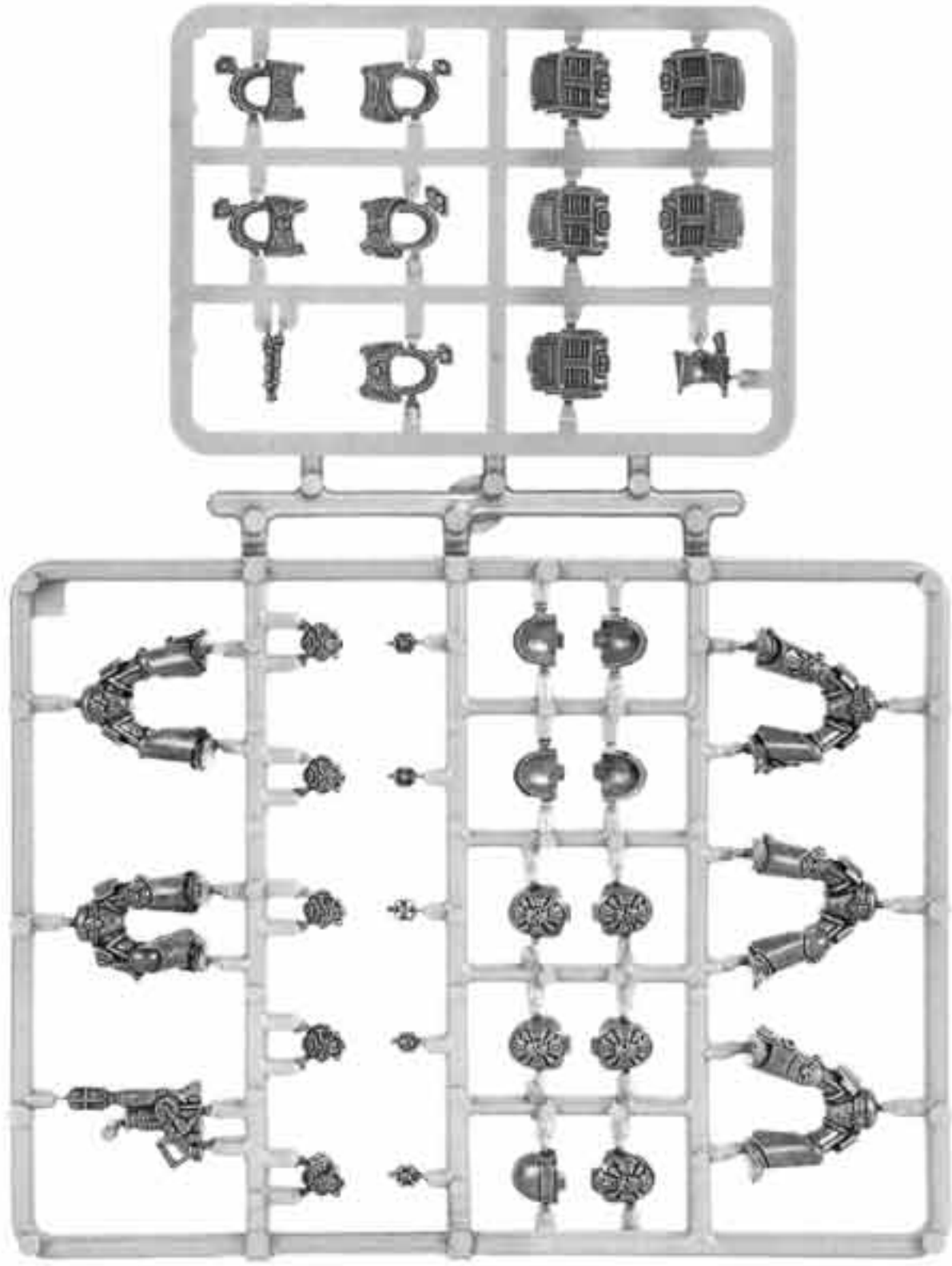

TERMINATOR SPRUE A (SHOWN 60% ACTUAL SIZE)
99380101020

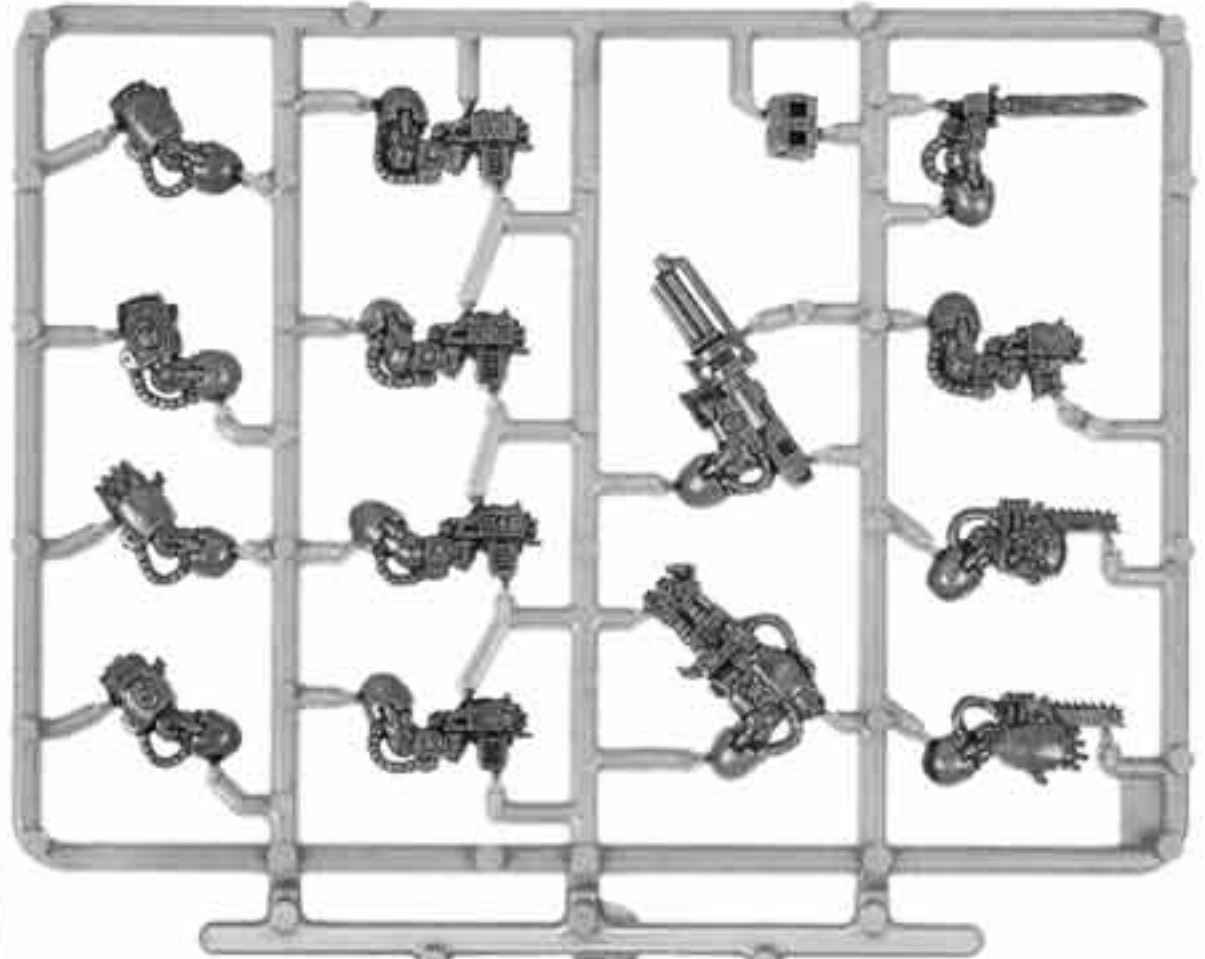

TERMINATOR SPRUE B (SHOWN 60% ACTUAL SIZE)
99380101021

All miniatures are supplied unpainted. Notch, hilt, and sprues are all shown actual size unless otherwise noted. Components may vary slightly from those shown.

ELITES



Ultramarine Tyrannid Hunters Blister (Random 2)
99060101316



TYRANID HUNTER 1
9947010131601



TYRANID HUNTER 2
9947010131602



TYRANID HUNTER 3
9947010131603



TYRANID HUNTER 4
9947010131604





ELITES



The Space Marine Dreadnought boxed set (99120101014) also includes the Space Marine Decal Sheet (99510101102) shown at the end of the Space Marines section.



Space Marine Dreadnought Box (1)
99120101014



DREADNOUGHT PLASTIC BASE
99390101008

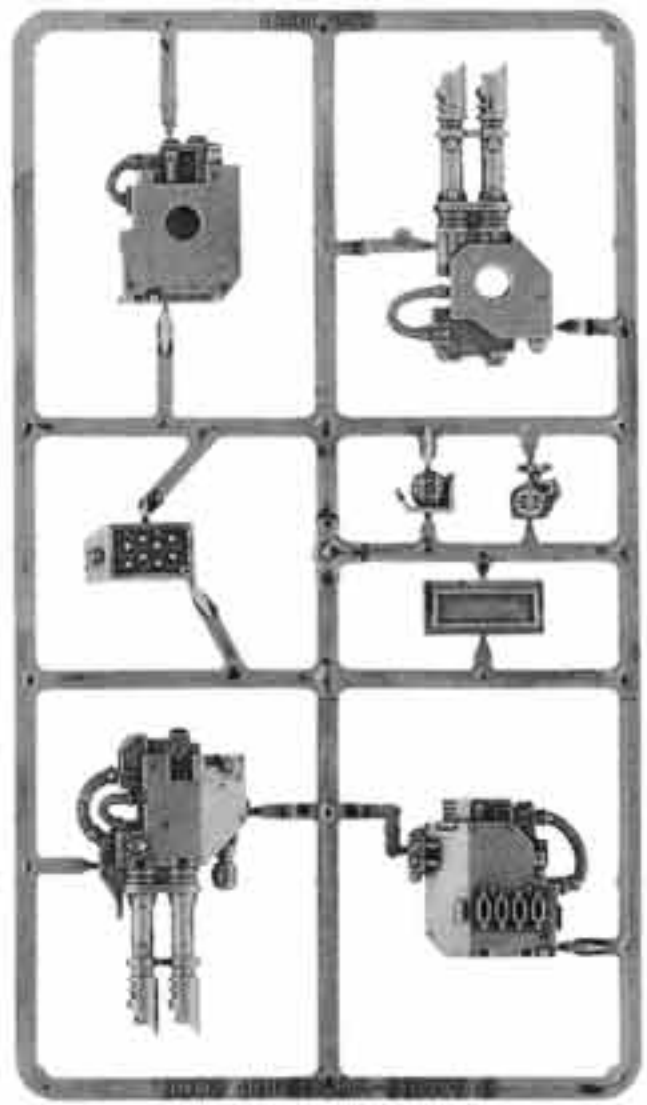

DREADNOUGHT LASCANNON/MISSILE LAUNCHER SPRUE
(SHOWN 50% ACTUAL SIZE)
AVAILABLE ONLY IN BOXED SET

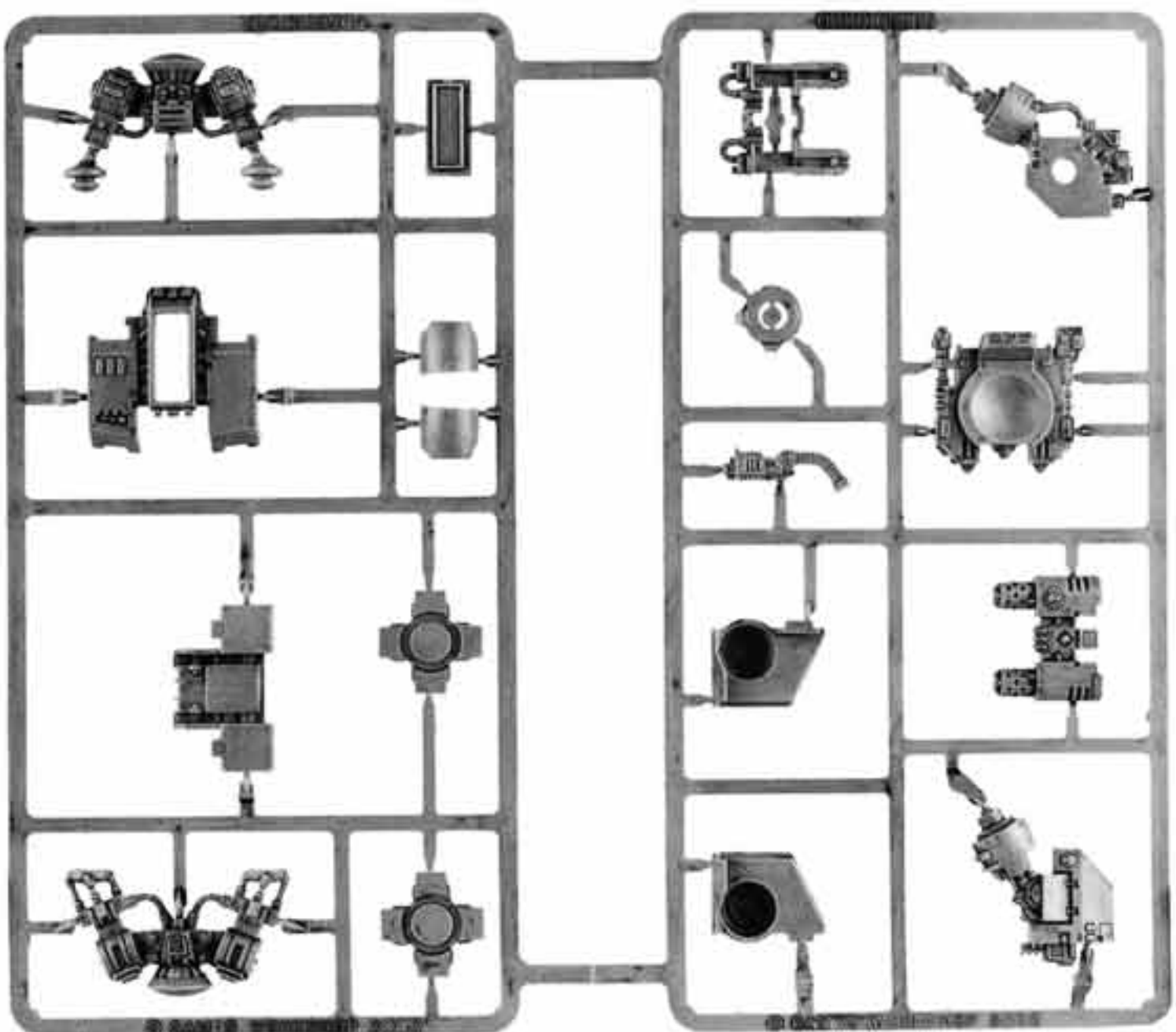

DREADNOUGHT SPRUE (SHOWN 50% ACTUAL SIZE)
AVAILABLE ONLY IN BOXED SET

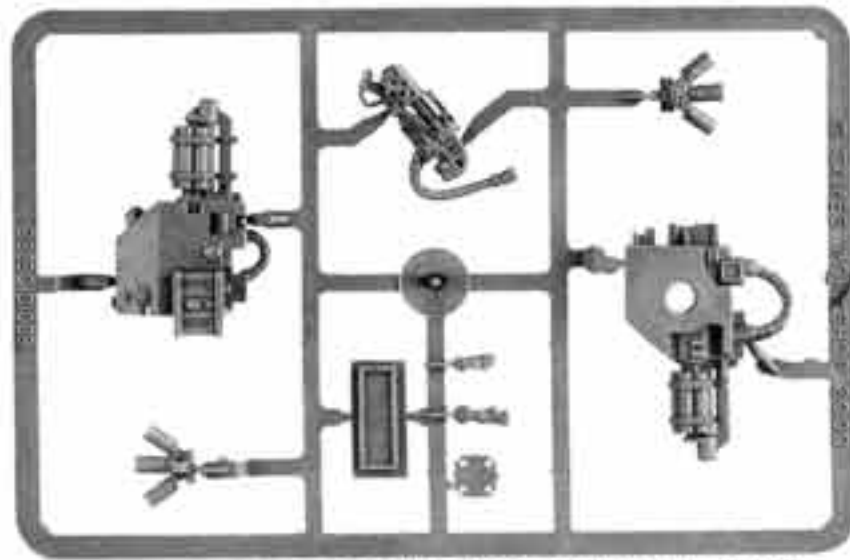

DREADNOUGHT ASSAULT CANNON/FLAMER SPRUE
(SHOWN 50% ACTUAL SIZE)
AVAILABLE ONLY IN BOXED SET

All miniatures are supplied unpainted. Nuts, bits, and sprues are all shown at full size unless otherwise noted. Contents may vary slightly from those shown.



The Blood Angels Furious Dreadnought boxed set (99120101014) also includes the Space Marine Decal Sheet (99510101102) shown at the end of the Space Marines section.

Blood Angels Furious Dreadnought Box (1)
99110101227



FURIOSO POWER FIST
9947010122702



BLOOD ANGELS SARCOPHAGUS
9947010100201

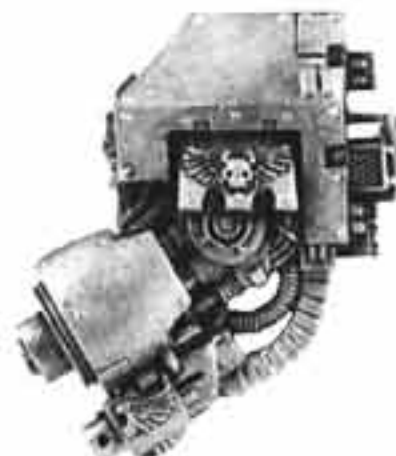

FURIOSO LEFT ARM FLAMER
9947010100205

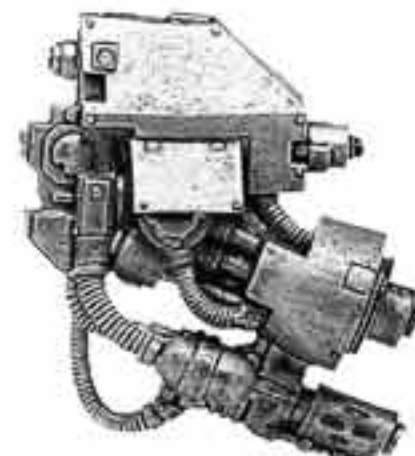

FURIOSO RIGHT ARM
9947010122701

All of the bits in this frame are included with both of the Dreadnought boxed sets on this page.

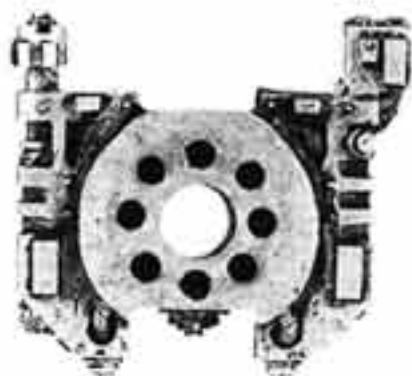

DREADNOUGHT LOWER BODY
9947010100202

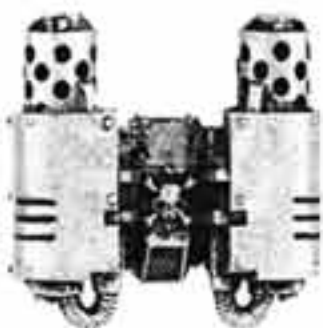

DREADNOUGHT POWER PLANT
9947010100204



VENERABLE DREADNOUGHT REAR BODY
9947010100411

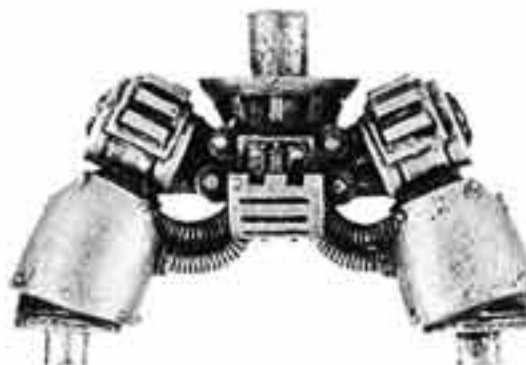

DREADNOUGHT LEGS
9947010100209



DREADNOUGHT FOOT
9947010100208



DREADNOUGHT AUTO LAUNCHER
9947010100207



The Space Wolves Venerable Dreadnought boxed set (99110101004) also includes the Space Wolf Decal Sheet (99510101103) shown at the end of the Space Marines section.

Space Wolves Venerable Dreadnought Box (1)
99110101004



DREADNOUGHT LIGHTNING CLAW
9947010100414

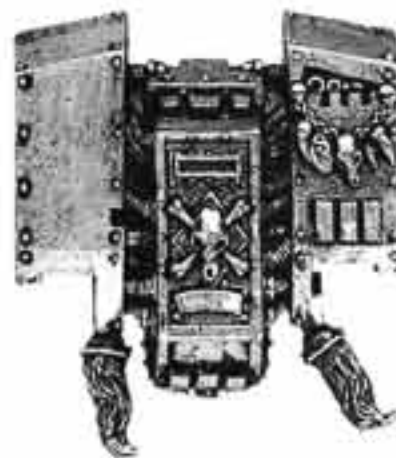

SPACE WOLVES SARCOPHAGUS
9947010100410



DREADNOUGHT LIGHTNING CLAW ARM
9947010100413



ELITES

The Space Marine Techmarine & Servitors boxed set (99110101312) also includes the Space Marine Decal Sheet (99510101102) shown at the end of the Space Marines section.



Space Marine Techmarine & Servitors Box (5)
99110101312

Space Marine Servitors Blister (Random 2)
99060101307



TECHMARINE BODY
9947010131201



TECHMARINE POWER AXE
09947010131202



SERVO HARNESS FLAMER
9947010131208



SERVO HARNESS BACKPACK
9947010131209



TECHMARINE SIGNUM
9947010131203



TECHMARINE BOLTER
9947010131204



TECHMARINE SERVITOR 1
9947010131210



TECHMARINE SERVITOR 2
9947010131211



SERVO HARNESS ARM 1
9947010131206



SERVO HARNESS ARM 2
9947010131207



SERVO HARNESS PLASMA CUTTER
9947010131205



TECHMARINE SERVITOR 3
9947010131212



TECHMARINE SERVITOR 4
9947010131213



SERVITOR HEAVY BOLTER
9947010131218



SERVITOR HEAVY BOLTER BACKPACK
9947010131219



SERVITOR MULTI MELTA
9947010131220



SERVITOR MULTI MELTA BACKPACK
9947010131221



SERVITOR ARM 1
9947010131214



SERVITOR ARM 2
9947010131215



SERVITOR ARM 3
9947010131216



SERVITOR ARM 4
9947010131217



The Techmarines on this page are available only via special offer.



TECHMARINE 1
9947010107501

TECHMARINE 2
9947010107502



TECHMARINE BACKPACK
9947010107503

Space Marine Techmarine Blister (Random 1)
99060101075



Command Squad Techmarine
Only Available As Bitz



Techmarine Blister (1)
99060101313



TECHMARINE POWER AXE
9947010110306



TECHMARINE BODY
9947010110305



Space Wolf Iron Priest Blister (1)
99060101067



ELITES

TRANSFERS ON SHOULDER PADS

Waterslide transfers are an excellent way to give all of your Space Marines identical markings without going through the painstaking and time-consuming process of painting each one by hand.



Cut out a transfer from a sheet (packed in with most Space Marines boxed sets) and hold it by the paper with a pair of tweezers in a small cup or saucer of water for about 30 seconds.

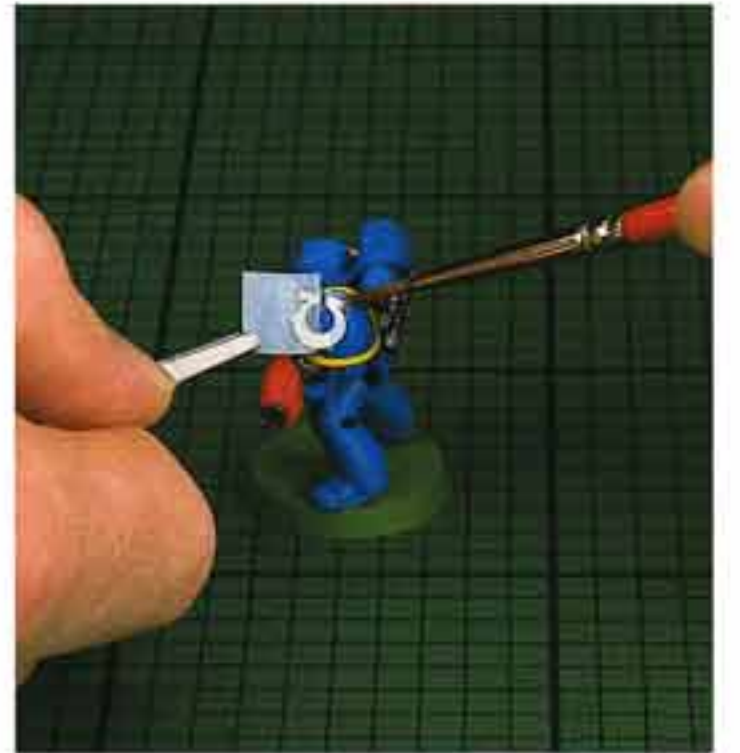

Then, using a pair of tweezers and a brush, slide the transfer off its backing paper and onto your model. Use the corner of a tissue to dab away any excess water from the model.

To avoid wrinkles forming in the transfer as it dries, there are a couple of methods you can use. One of them is often called "burnishing" – gently use the handle of a paint brush to rub out the wrinkles while the transfer is drying. Or you can use a special chemical solution (the one we use has the brand name "Micro-Set") that actually warps the transfer to conform to the curve and to prevent wrinkles.



ELITES



These models and their bits are available only via special offer.



WOLF GUARD 4
9947010106504



WOLF GUARD COMPANY STANDARD
9947010106502



WOLF GUARD 3
9947010106503



WOLF GUARD 1
9947010106501



BLOOD CLAW SERGEANT
9947010101601



LONG FANG SERGEANT
9947010101501



GREY HUNTER SERGEANT
9947010101301



WOLF CAPTAIN W/ WOLF HEAD
9947010106505

Space Wolves Wolf Guard Blister (Random 1)
99060101065

All miniature are supplied unpainted. Models, bits, and sprues are all shown as they will appear when assembled. Contents may vary slightly from those shown.



13TH COMPANY WULFEN 3
9947010124003

13TH COMPANY WULFEN 2
9947010124002

13TH COMPANY WULFEN 1
9947010124001

13TH COMPANY WULFEN 5
9947010124005

13TH COMPANY WULFEN 4
9947010124004

13th Company Wulfen Box (5)
99110101240

The 13th Company Wulfen boxed set (99110101240) also contains the Space Marine Backpack sprue (99380101004) shown earlier in this section, as well as 1 Chaos Backpack (99390102003) shown in the Chaos Space Marines section.



WOLF SCOUT W/
PLASMA PISTOL 2
9947010122902

WOLF SCOUT W/
MELTA GUN
9947010122903

WOLF SCOUT W/
PLASMA GUN
9947010122904

WOLF SCOUT W/
PLASMA PISTOL 1
9947010122901

Space Wolf Scouts w/ Assault Weapons Blister (Random 2)
99060101229

The Space Wolf Wolf Scouts with Assault Weapons blister (99060101229) contains one random Scout w/ Plasma Pistol and one random Scout w/ Assault Weapon.



WOLF SCOUT 2
9947010122801

WOLF SCOUT 3
9947010122802

WOLF SCOUT 4
9947010122803

WOLF SCOUT SERGEANT
9947010123001

Space Wolf Wolf Scouts Blister (Random 2)
99060101228

Space Wolf Wolf Scouts blister (99060101228) contains two random models from the ones shown here.



TROOPS

The Space Marine Combat Squad boxed set (99120101024) contains five regular Tactical Marines with no upgrades or special weapons.



Space Marine Tactical Squad Box (10)
99120101025

Space Marine Combat Squad Box (5)
99120101024

The Space Marine Tactical Squad boxed set (99120101025) also includes the Space Marine Decal Sheet (99510101102) shown at the end of the Space Marines section.

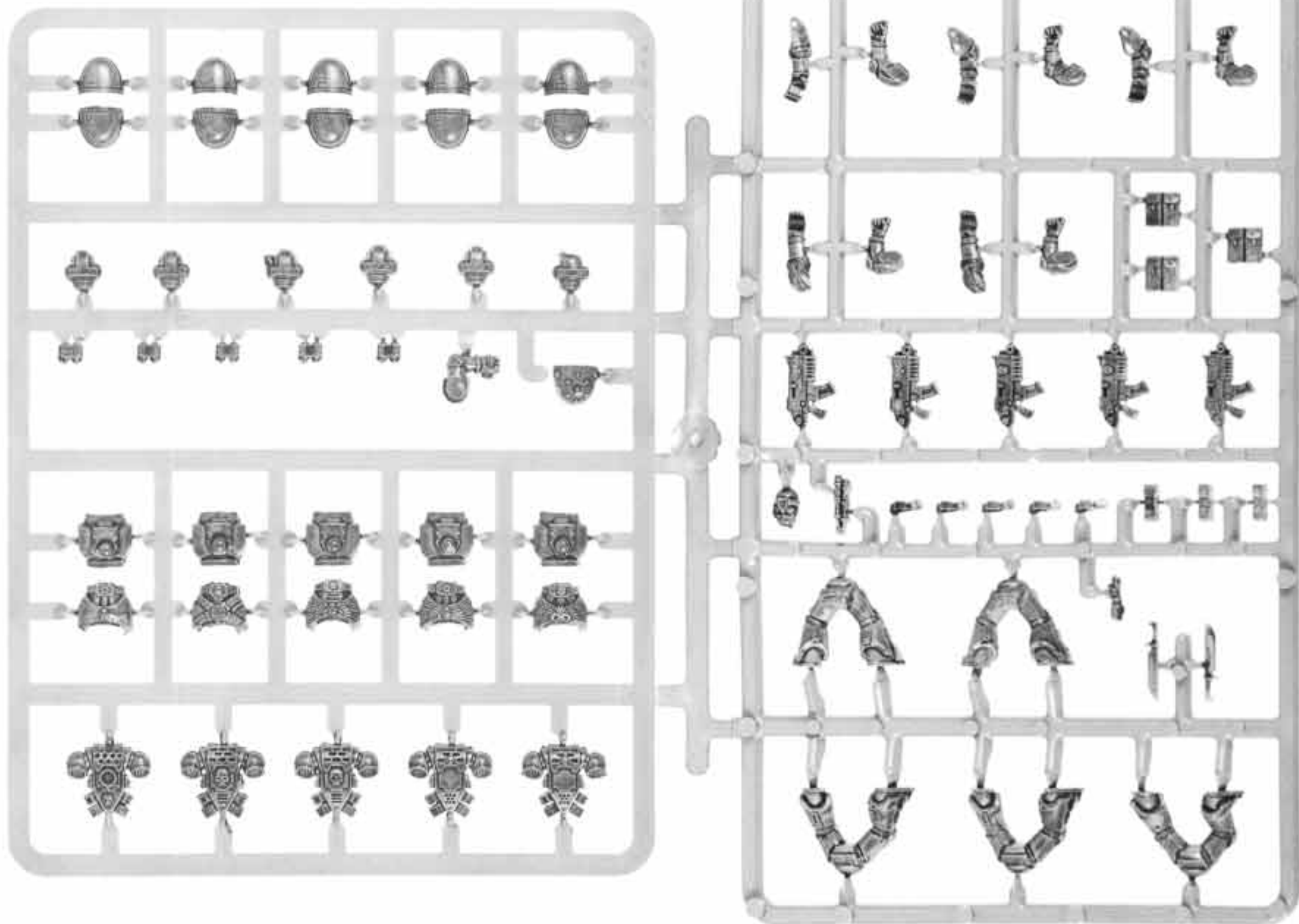

SPACE MARINE TACTICAL SQUAD SPRUE (SHOWN 70% ACTUAL SIZE)
AVAILABLE ONLY IN BOXED SET

TROOPS

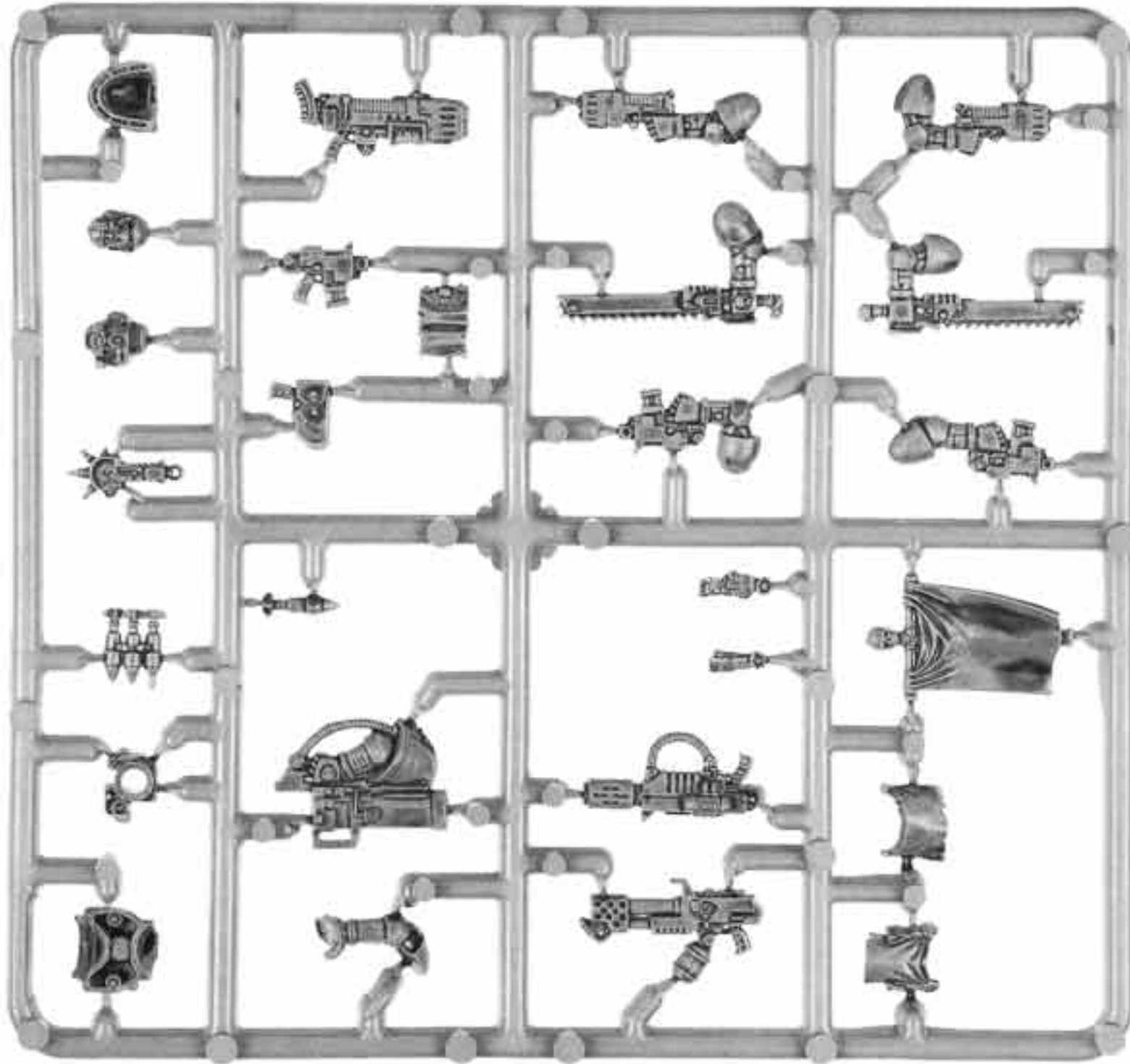

SPACE MARINE TACTICAL UPGRADE SPRUE (SHOWN 85% ACTUAL SIZE)
99380101025



These bits are available only via special offer.



ASSAULT WEAPON
SPACE MARINE 1
9947010119202



ASSAULT WEAPON
SPACE MARINE 2
9947010119203



ASSAULT WEAPON
SPACE MARINE 3
9947010119204



SPACE MARINE
PLASMA GUN
9947010117704



SPACE MARINE
MELTA GUN
9947010119201

Space Marine w/ Assault
Weapon Blister (Random 2)
99060101244





TROOPS



Dark Angels Tactical Squad Box (10)
99110101232

The Dark Angels Tactical Squad boxed set (99110101232) also contains the Space Marine Backpack sprue (99380101004) and the Space Marine Arms, Bolters & Pads sprue (99380101005) shown with the Space Marine Command Squad. It also contains Space Marines Decal Sheet (99510101102) shown at the end of the Space Marines section.



DARK ANGELS VETERAN SERGEANT 1
9947010123201



DARK ANGELS PLASMA CANNON BACKPACK
9947010123202



DARK ANGELS PLASMA CANNON ARM
9947010123204



DARK ANGELS PLASMA CANNON
9947010123203



Dark Angels Veteran Marines Blister (Random 2)
99060101195



DARK ANGEL VETERAN BODY 1
9947010119501



DARK ANGEL VETERAN BODY 2
9947010119502



DARK ANGEL VETERAN BODY 3
9947010119503

The Dark Angels Veteran Marines blister (99060101195) also contains two backpacks from the Space Marine Backpack sprue (99380101004) and the Space Marine Arms, Bolters & Pads sprue (99380101005) shown with the Space Marine Command Squad as well as two random Dark Angels shoulder pads shown at the end of the Space Marines section.



These bits are available only via special offer.



BLOOD ANGELS MARINE 3
9947010100102



BLOOD ANGELS MARINE 1
9947010100103



BLOOD ANGELS MARINE 2
9947010100104

Blood Angels Space Marines
Available Only as Bitz

TROOPS

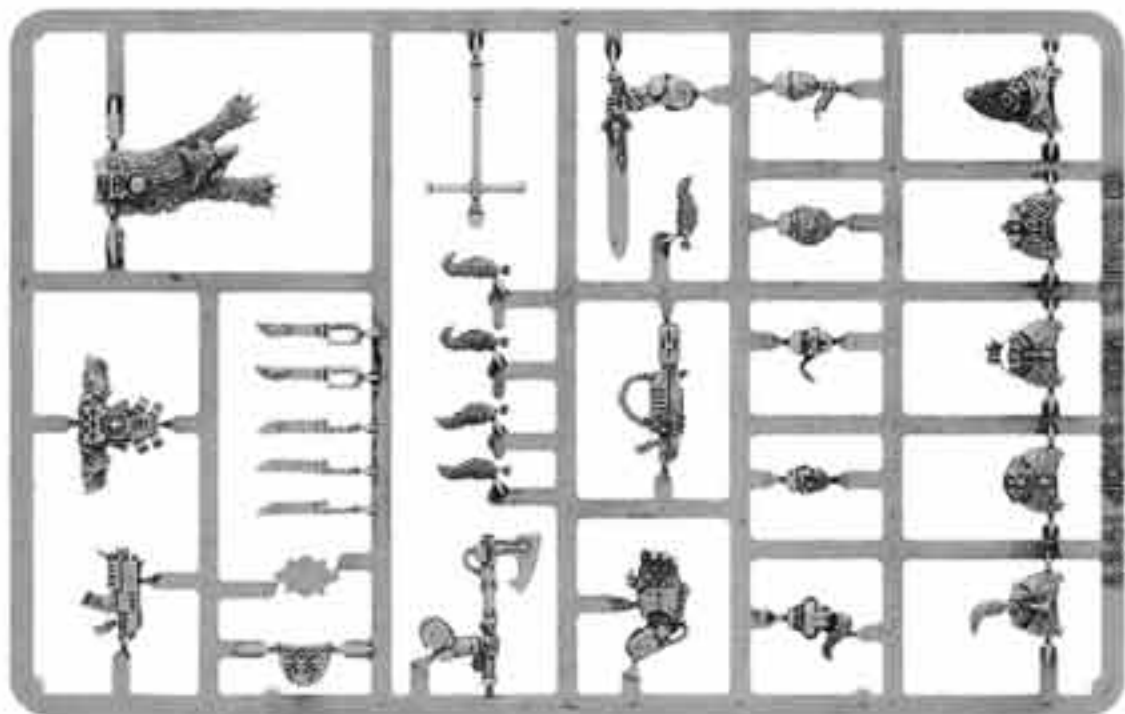

Both of the boxed sets shown on this page contain this Space Wolves Accessories sprue.



SPACE WOLF ACCESSORIES SPRUE (SHOWN 65% ACTUAL SIZE)
99380101012



The Space Wolf Grey Hunters boxed set (99120101012) also contains the Space Marine Backpack Sprue (99380101004) and the Space Marine Bolter and Arms Sprue (99380101005) shown earlier in this section as well as the Space Wolves Decal Sheet (99510101103) shown at the end of the Space Marines section.



Space Wolf Grey Hunters Box (10)
99120101012



The Space Wolf Blood Claws boxed set (99120101011) also contains the Space Marine Backpack Sprue (99380101004) and the Left and Right Assault Arm Sprues (99380101008 & 99380101009) shown earlier in this section as well as the Space Wolves Decal Sheet (99510101103) shown at the end of the Space Marines section.



Space Wolf Blood Claws Box (10)
99120101011



TROOPS



All of the items on this page are available only via special offer.



L.O.D. GUN SPRUE A
9947010109612



**L.O.D. TROOPER 3
(MK6 RIBCAGE)**
9947010109607



**L.O.D. TROOPER 6
(RIBCAGE MK7)**
9947010109610



**L.O.D. TROOPER 8
(RIBS & FLAMES)**
9947010109728



**L.O.D. TROOPER 11
(MK6)**
9947010109731



**L.O.D. SERGEANT 1
(CHAINSWORD)**
9947010109601

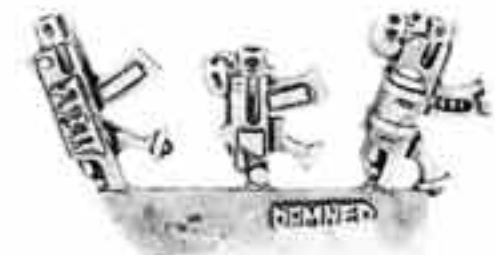

L.O.D. GUN SPRUE B
9947010109613



**L.O.D. TROOPER 12
(FLAME CHEST)**
9947010109732



**L.O.D. TROOPER 13
(TWIN RIBS CHEST)**
9947010109733



**L.O.D. TROOPER 14
(MK6 SKULL/BONES)**
9947010109734

Legion of the Damned Devastators can be found with the rest of the Space Marines Heavy Support later in this section.
Legion of the Damned shoulder pads can be found with the shoulder pads later in this section.



L.O.D. BACKPACK 1
9947010109615



L.O.D. BACKPACK 2
9947010109616



L.O.D. BACKPACK 3
9947010109614



**IMPERIAL FISTS
HEAVY FLAMER**
9947010110703



**IMPERIAL FISTS
STORM BOLTER 1**
9947010110701



**IMPERIAL FISTS
STORM BOLTER 2**
9947010110702



**IMPERIAL FISTS
EQUIPMENT SPRUE**
9947010110806



**IMPERIAL FISTS
BACKPACK**
9947010124202



**IMPERIAL FISTS
STORM SHIELD**
9947010110705



**IMPERIAL FISTS
BANNER POLE**
9947010110704

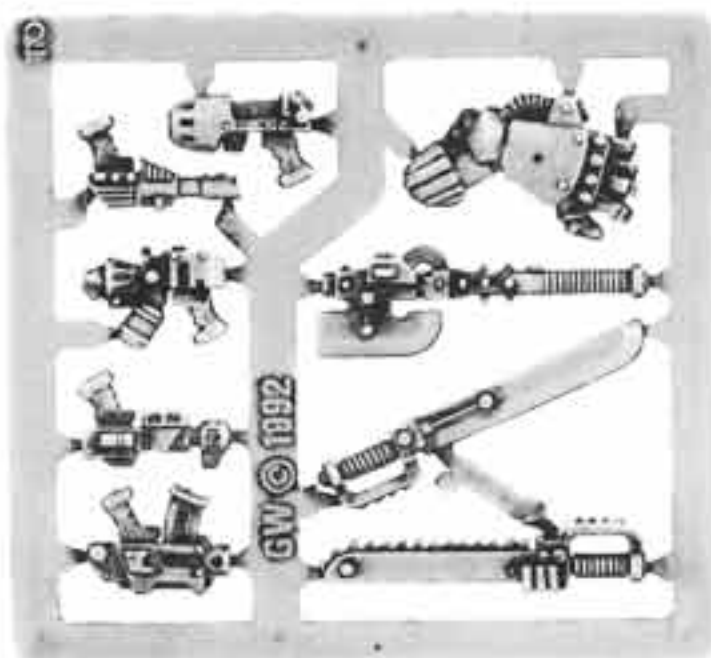

CLOSE COMBAT WEAPONS SPRUE
99399999014

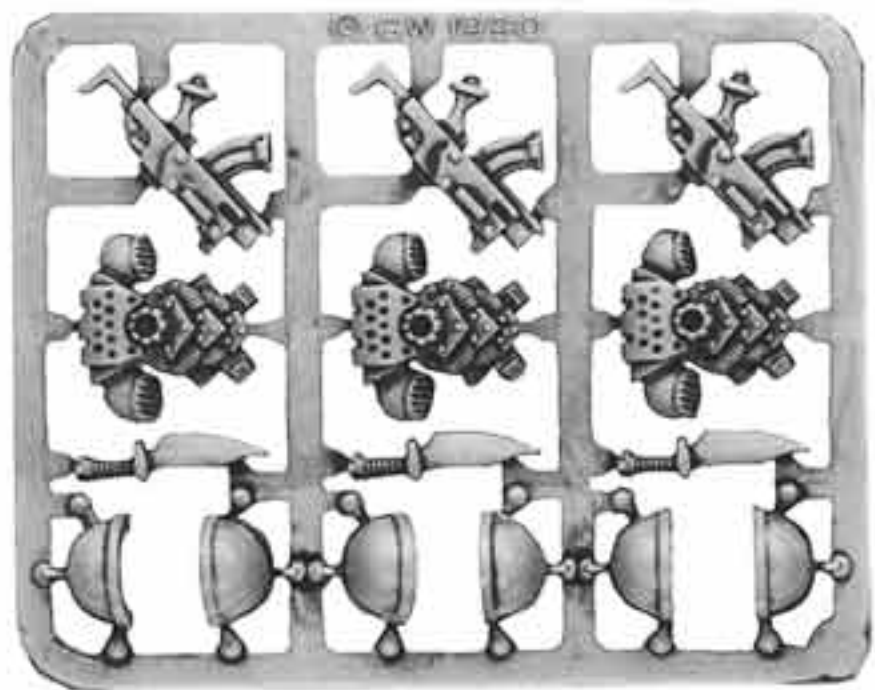

BACKPACKS, BOLTERS & SHOULDER PADS SPRUE
99399999031

TROOPS



All of the items on this page are available only via special offer.



Iron Hands Iron Father Blister (1)
99060101298



IRON FATHER BODY
9947010129801



IRON FATHER SERVO ARM
9947010129802



IRON FATHER SHOULDER PAD
9947010129803



IRON FATHER BACKPACK
9947010129804



Iron Hands Space Marines
Available Only As Bitz



IRON HANDS HEAD SPRUE 1
9947010129701



IRON HANDS HEAD SPRUE 2
9947010129702



IRON HANDS TORSO 1
9947010129703



IRON HANDS TORSO 2
9947010129704



IRON HANDS SHOULDER PAD SPRUE 1
9947010129705

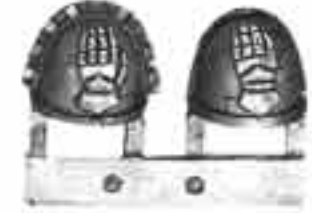

IRON HANDS SHOULDER PAD SPRUE 2
9947010129706



IRON HANDS ARM SPRUE 1
9947010129707



IRON HANDS ARM SPRUE 2
9947010129708



IRON HANDS THUNDER HAMMER
9947010129709



IRON HANDS LEGS 1
9947010129710



IRON HANDS LEGS 2
9947010129711



TROOPS



Space Marine Scout Squad Box (5)
99110101088

The Space Marine Scout Squad boxed set (99120101025) also includes the Space Marine Decal Sheet (99510101102) shown at the end of the Space Marines section.



**SPACE MARINES
SCOUT 1**
9947010108801

**SPACE MARINES
SCOUT SERGEANT**
9947010108802

**SPACE MARINES
SCOUT 2**
9947010108803

**SPACE MARINES
SCOUT 3**
9947010108804

**SPACE MARINES
SCOUT 4**
9947010108805



This blister & bit are available via special offer only.



**Space Marine Scout
Sergeant Blister (1)**
99060101092
BIT NAME: SCOUT SERGEANT
BIT CODE: 9947010108802



All miniatures are supplied unpainted. Models, bits, and sprues are all shown actual size unless otherwise noted. Contents may vary slightly from those shown.

TROOPS



SCOUT SNIPER 1
(STANDING)
9947010109001

SCOUT SNIPER 2
(KNEELING)
9947010109002

Space Marine Scouts
w/ Needle Rifles Blister (2)
99060101179



Space Marine Scout w/
Heavy Bolter Blister (1)
99060101091



SCOUT W/ HEAVY
BOLTER BODY
9947010109101



SCOUT HEAVY
BOLTER BI-POD
9947010109103



SCOUT HEAVY BOLTER
9947010109102



Space Marine Scout with
Missile Launcher Blister (1)
99060101301

BIT NAME: SCOUT
W/ MISSILE LAUNCHER
BIT CODE: 9947010130101



SCOUT
W/ BOLTER 1
9947010111301

SCOUT
W/ BOLTER 2
9947010111302

Space Marine Scouts
w/ Bolters Blister (2)
99060101113



SCOUT
W/ SHOTGUN 1
9947010109003

SCOUT
W/ SHOTGUN 2
9947010117804

Space Marine Scouts
w/ Shotguns Blisters (2)
99060101178



SPACE MARINE
SCOUT 4
9947010108805

SPACE MARINE
SCOUT 5
9947010109307

SPACE MARINE
SCOUT 6
9947010109306

SPACE MARINE
SCOUT 1
9947010108801

SPACE MARINE
SCOUT 2
9947010108803

SPACE MARINE
SCOUT 3
9947010108804

Space Marine Scouts Blister (Random 2)
99060101093



TROOPS



Space Marine Rhino Tank Box (1)
99120101017

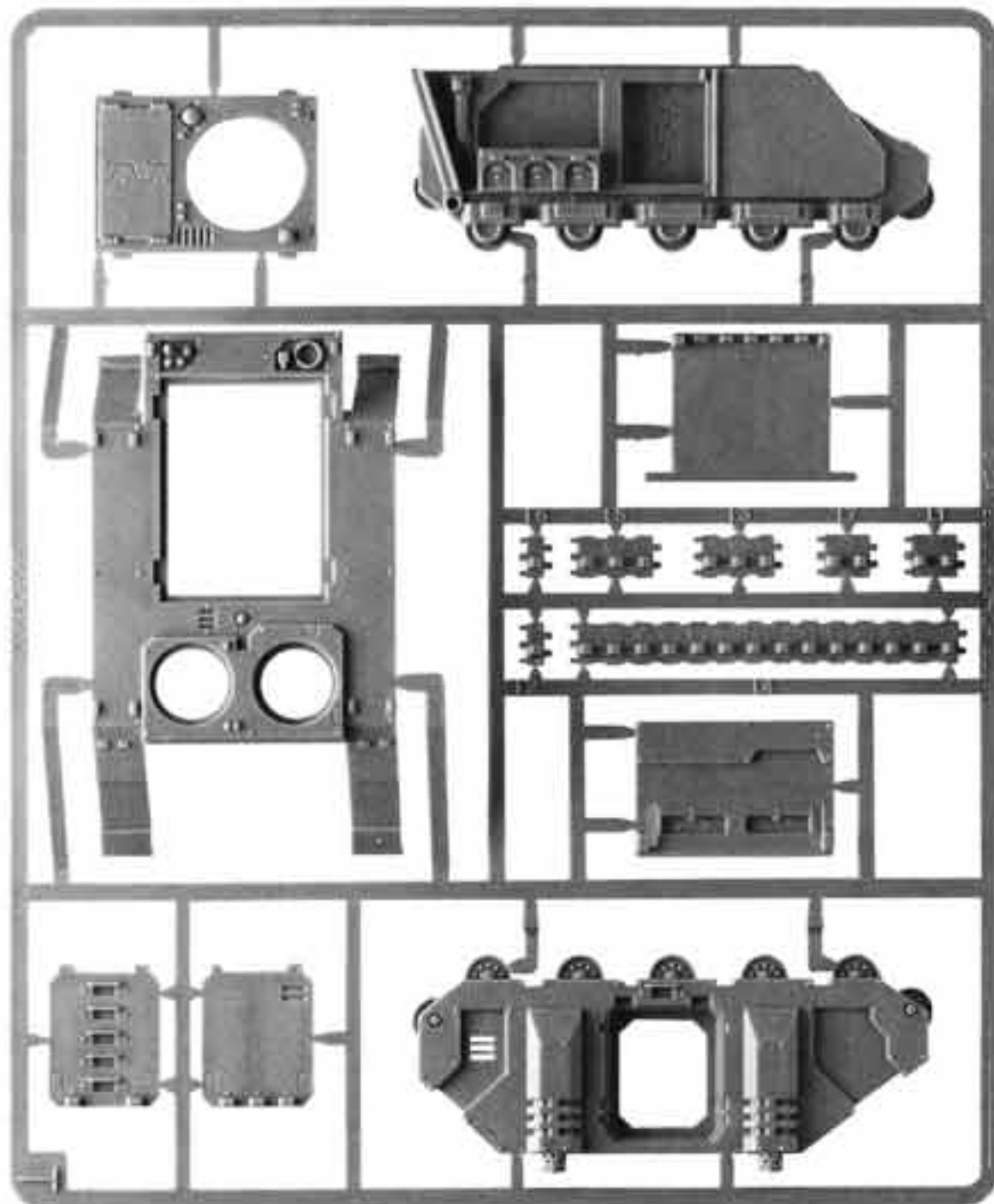

RHINO HULL SPRUE 2 (SHOWN 45% ACTUAL SIZE)
AVAILABLE ONLY IN BOXED SET

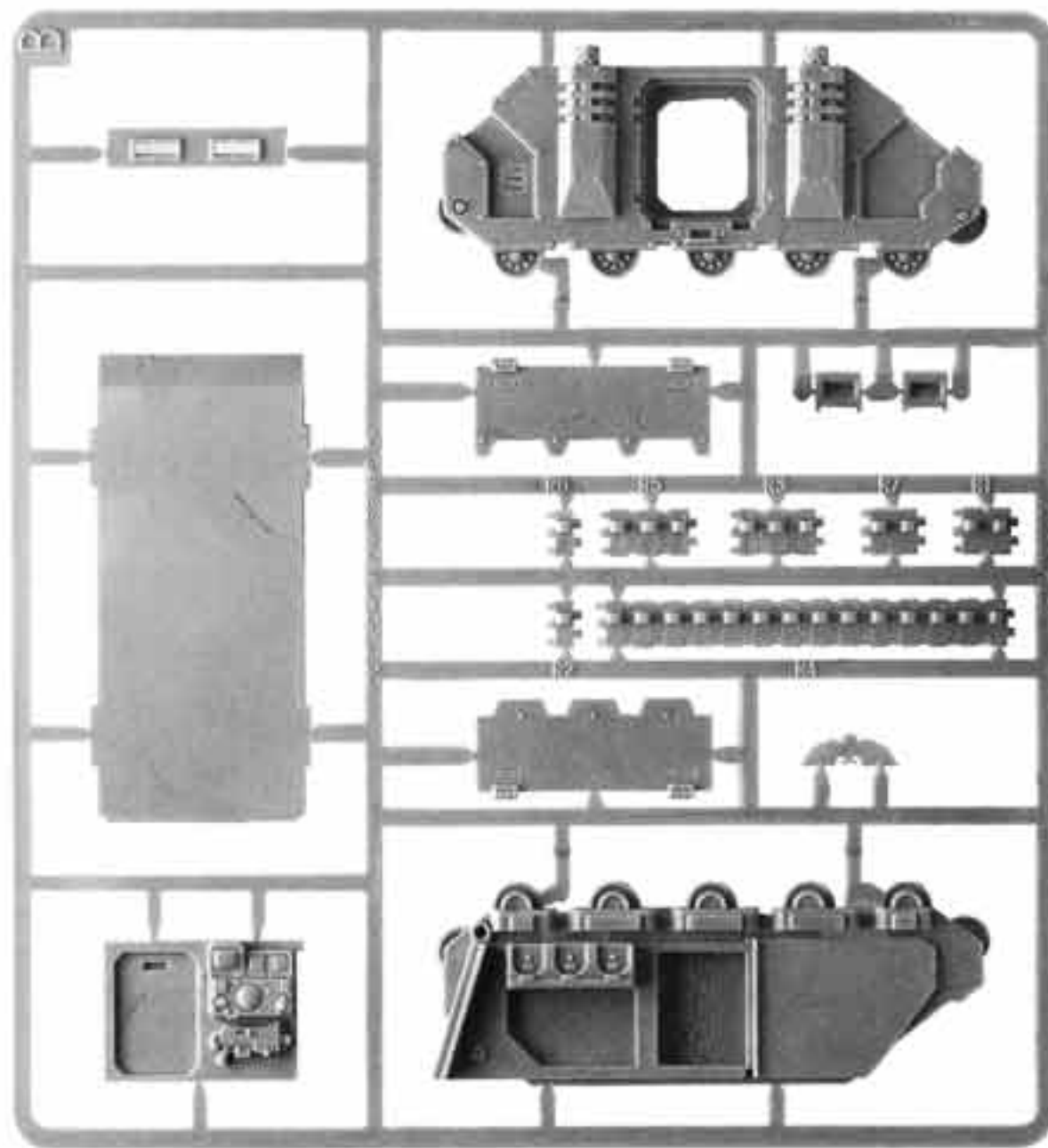

RHINO HULL SPRUE 1 (SHOWN 45% ACTUAL SIZE)
AVAILABLE ONLY IN BOXED SET



The Rhino boxed set (99120101017) also comes with the Land Raider Accessory Sprue (99390101004) shown with the Land Raider, the Space Marines Decal Sheet (99510101104), and the Space Wolves Decal Sheet (99510101103) shown at the end of this section.



Space Marine Razorback Tank Box (1)
99120101020

The Razorback boxed set (99120101020) also includes the sprues shown on the opposite page, the Land Raider Accessory Sprue (99390101004) shown with the Land Raider, the Space Marines Decal Sheet (99510101104), and the Space Wolves Decal Sheet (99510101103) shown at the end of this section.

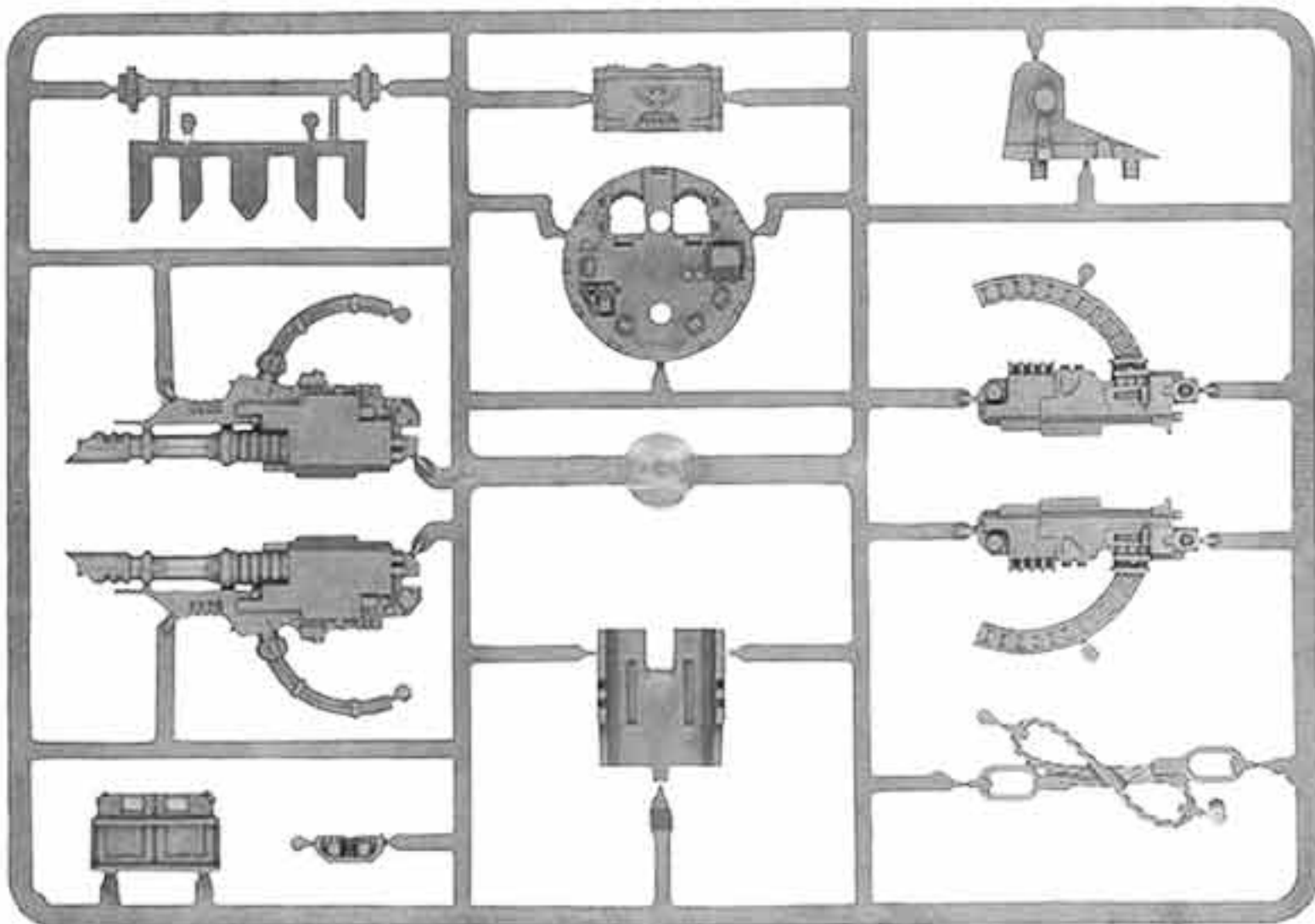

RAZORBACK SPRUE (SHOWN 70% ACTUAL SIZE)
99390199006

TROOPS

WEATHERED VEHICLE PAINT JOBS

Imperial Space Marines fight throughout the universe on a wide variety of planets with incredibly diverse terrain. Below are some examples of paint jobs that represent the residual damage these varied conditions can do to Space Marine vehicles.

SNOW AND ICE



BATTLE DAMAGE

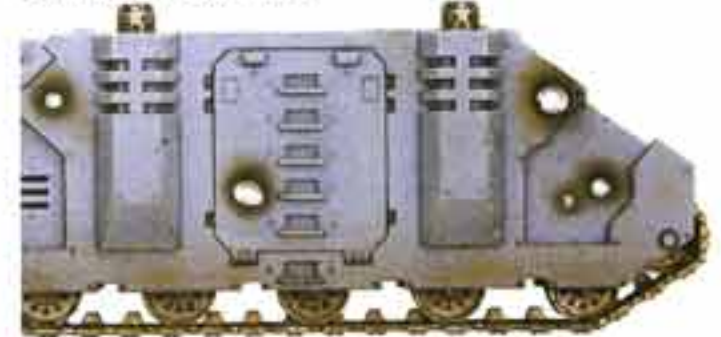

MUD AND CLAY



ACID WASTES

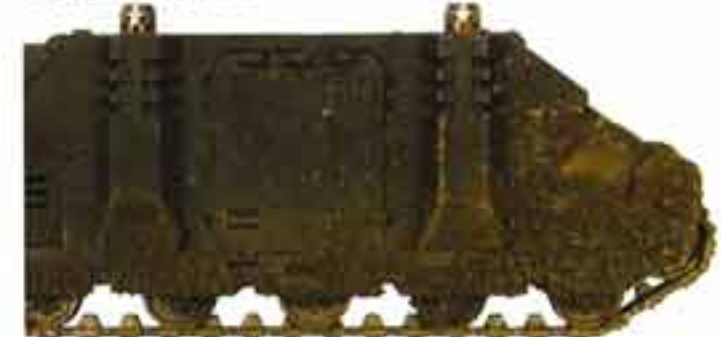

DESERT TERRAIN

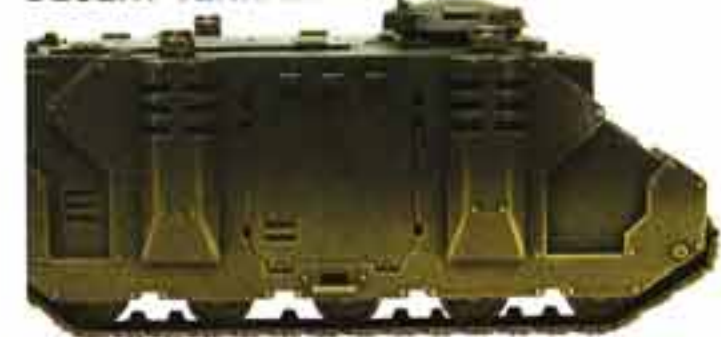

For more info on creating these and other effects, visit the hobby section of our web site or look for the painting articles published in *White Dwarf* magazine.



FAST ATTACK



Space Marine Assault Squad Box (5)
99120101034

The Space Marine Assault Squad boxed set (99120101034) also contains the Space Marine Decal Sheet (99510101102) shown at the end of this section.

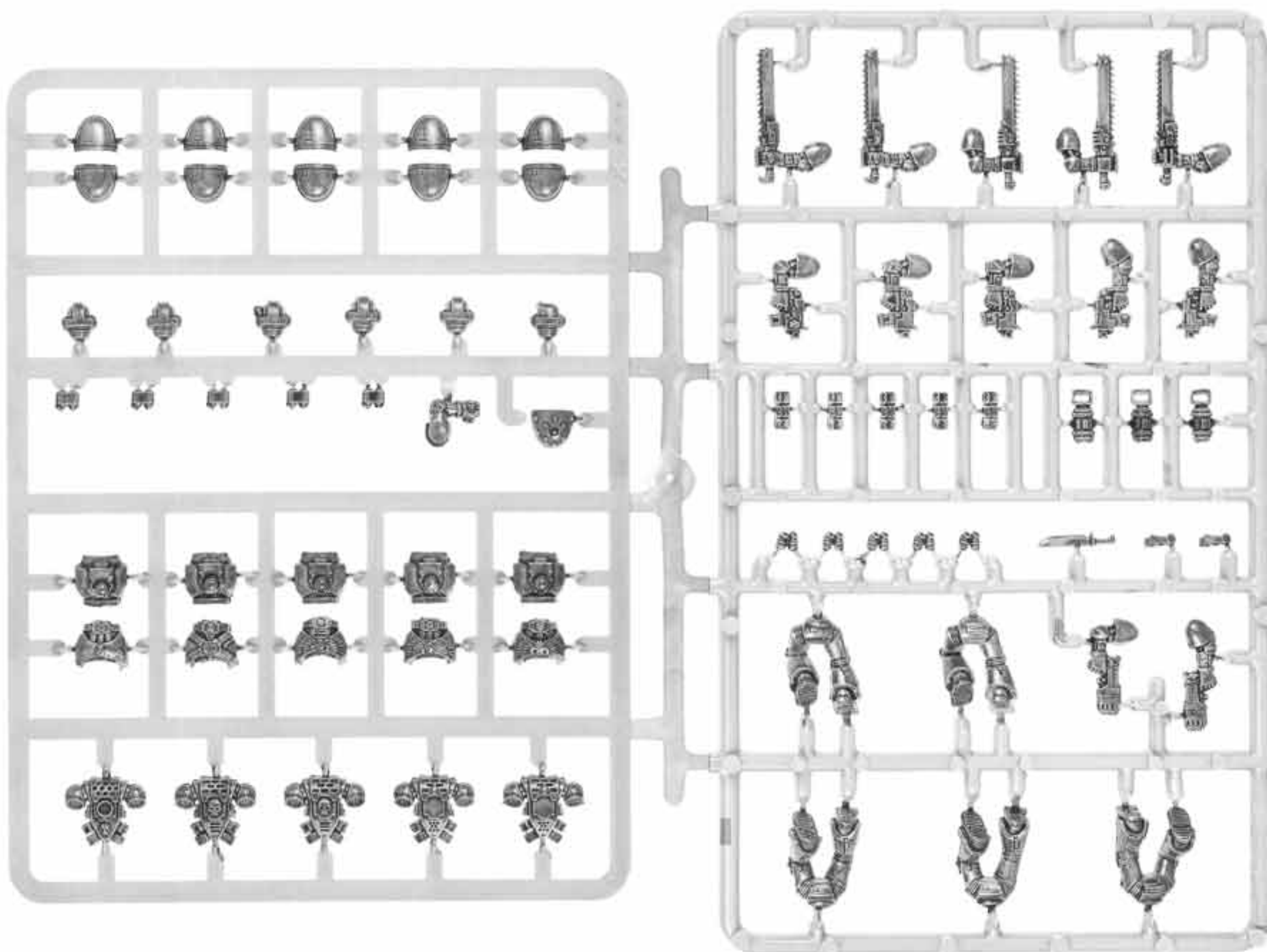

SPACE MARINE ASSAULT SQUAD SPRUE (SHOWN 70% ACTUAL SIZE)
AVAILABLE ONLY IN BOXED SET



These sprues are available only via special offer. They are not included in the Assault Squad boxed set but are included in some boxed sets shown earlier.



JUMP PACK SPRUE
99380101011

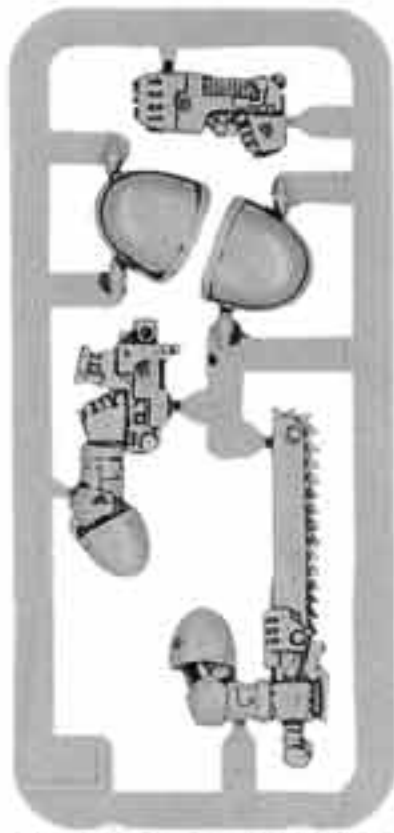

LEFT ARM ASSAULT SPRUE
99380101008

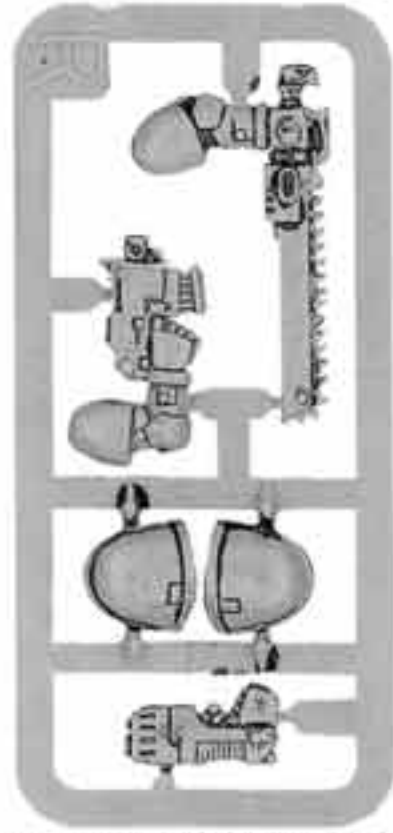

RIGHT ARM ASSAULT SPRUE
99380101009

FAST ATTACK



These bitz are available only via special offer.



ASSAULT SERGEANT 1
9947010101003



ASSAULT SERGEANT 2
9947010103001

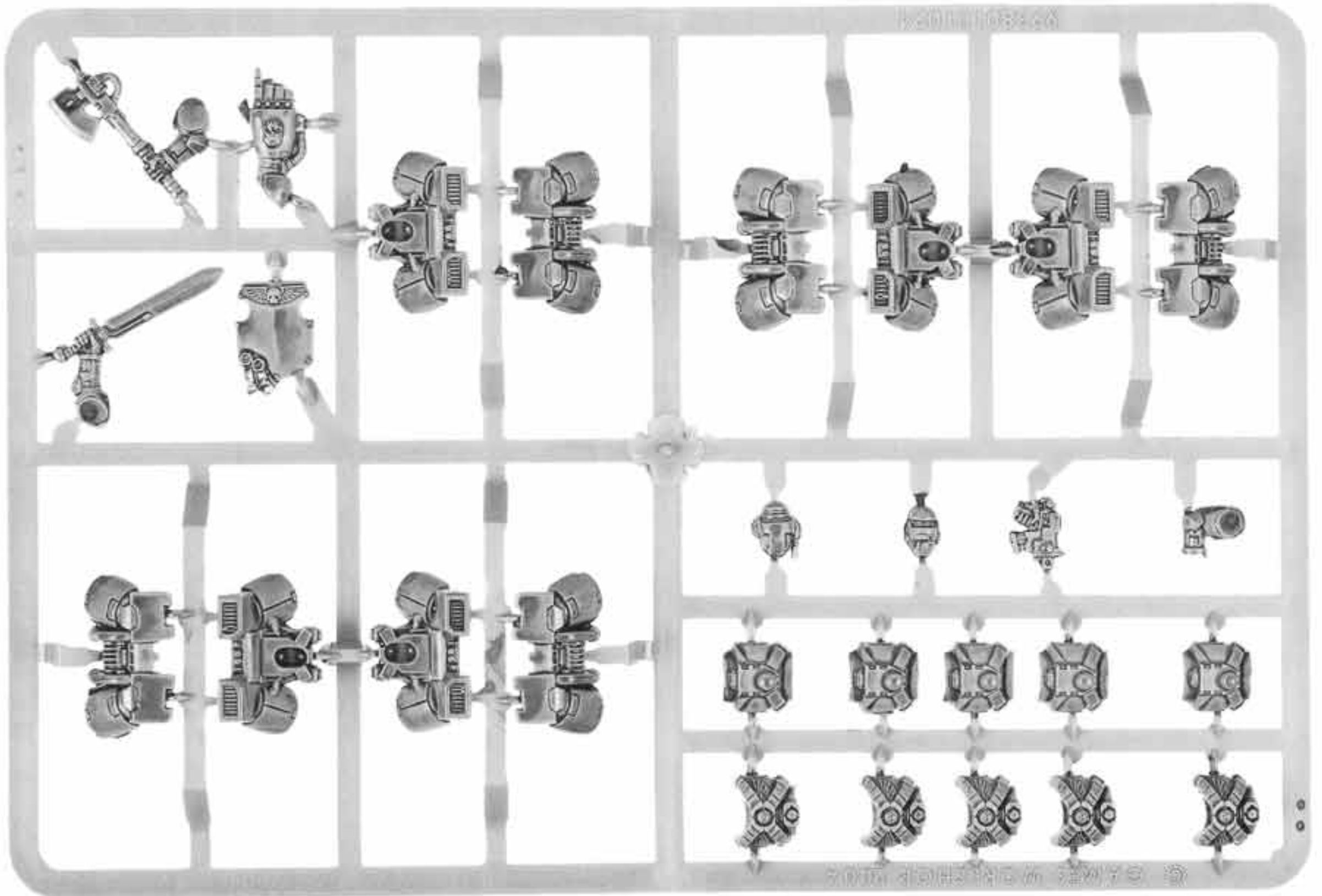

SPACE MARINE ASSAULT UPGRADE SPRUE
99380101024



FAST ATTACK

PURITY SEALS

Many of the Emperor's Finest proudly wear Purity Seals into battle as signs of their virtue and undying devotion to the Imperium. Want to make your own? Here's a quick run through telling you how.



Take a very small ball of putty and place it on a piece of plasticard or a spare base. Use the flat end of a drill bit (dipped in water to prevent sticking) to make a circular indentation in the putty. Let it cure and harden for 4-5 hours.

Gently pop the purity seal loose and glue it to the selected location – shoulder pad, greave, belt buckle, glove, weapon, etc. Let it dry and paint it with Chaos Black. Paint and highlight it with your chosen purity seal color. In this case, we used Red Gore as basecoat and then highlighted with Blood Red and Bad Moon Yellow.



Draw a trapezoid on a piece of paper. Thin down Snakebite Leather and paint a very light coat to give the paper the look of parchment. Highlight the edges with Skull White. Use Chaos Black to paint squiggly lines with a fine detail brush to represent writing. Carefully cut out the parchment (inside the pencil lines) with a hobby knife. Then hold the parchment with a pair of tweezers and carefully apply super glue to the top end. Affix the pieces of parchment to the bottom of the purity seal.



Space Marine Bike Box (1)
99120101002

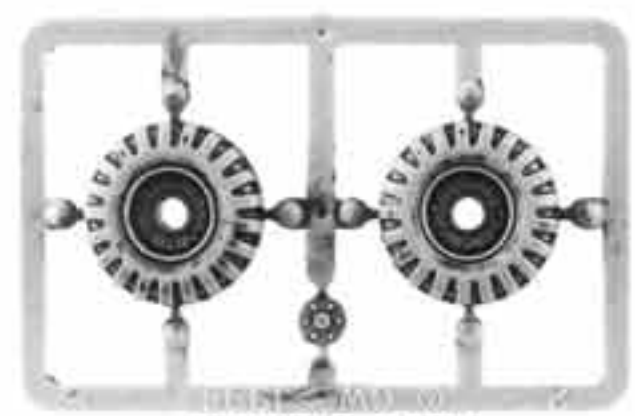

BIKE WHEEL SPRUE
99399999034

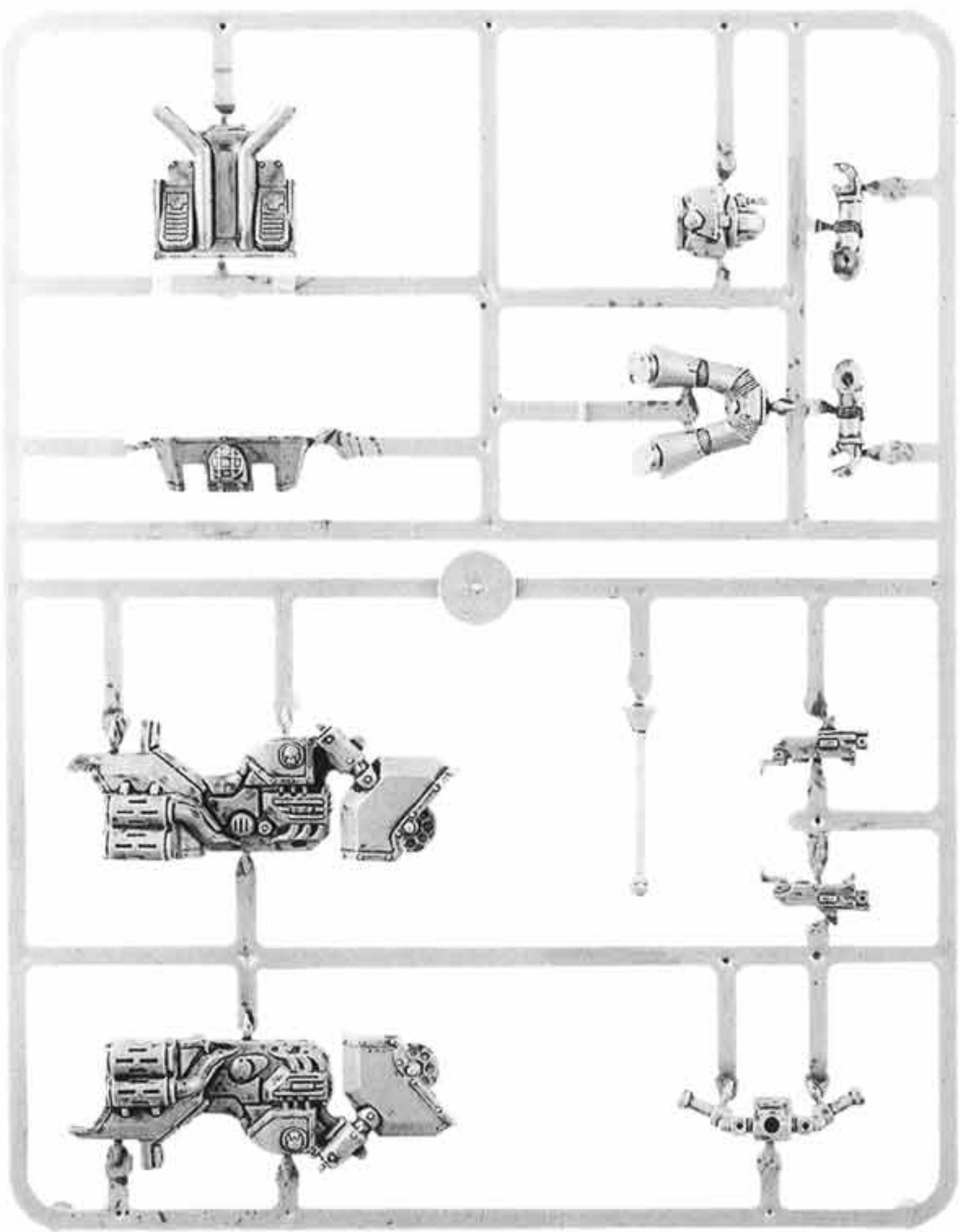

SPACE MARINE BIKE SPRUE (SHOWN 90% ACTUAL SIZE)
AVAILABLE ONLY IN BOXED SET



FAST ATTACK

The Space Marine Assault Squad boxed set (99120101034) also contains the Space Marine Decal Sheet (99510101102) shown at the end of this section.

Space Marine Attack Bike Box (1)
99120101030

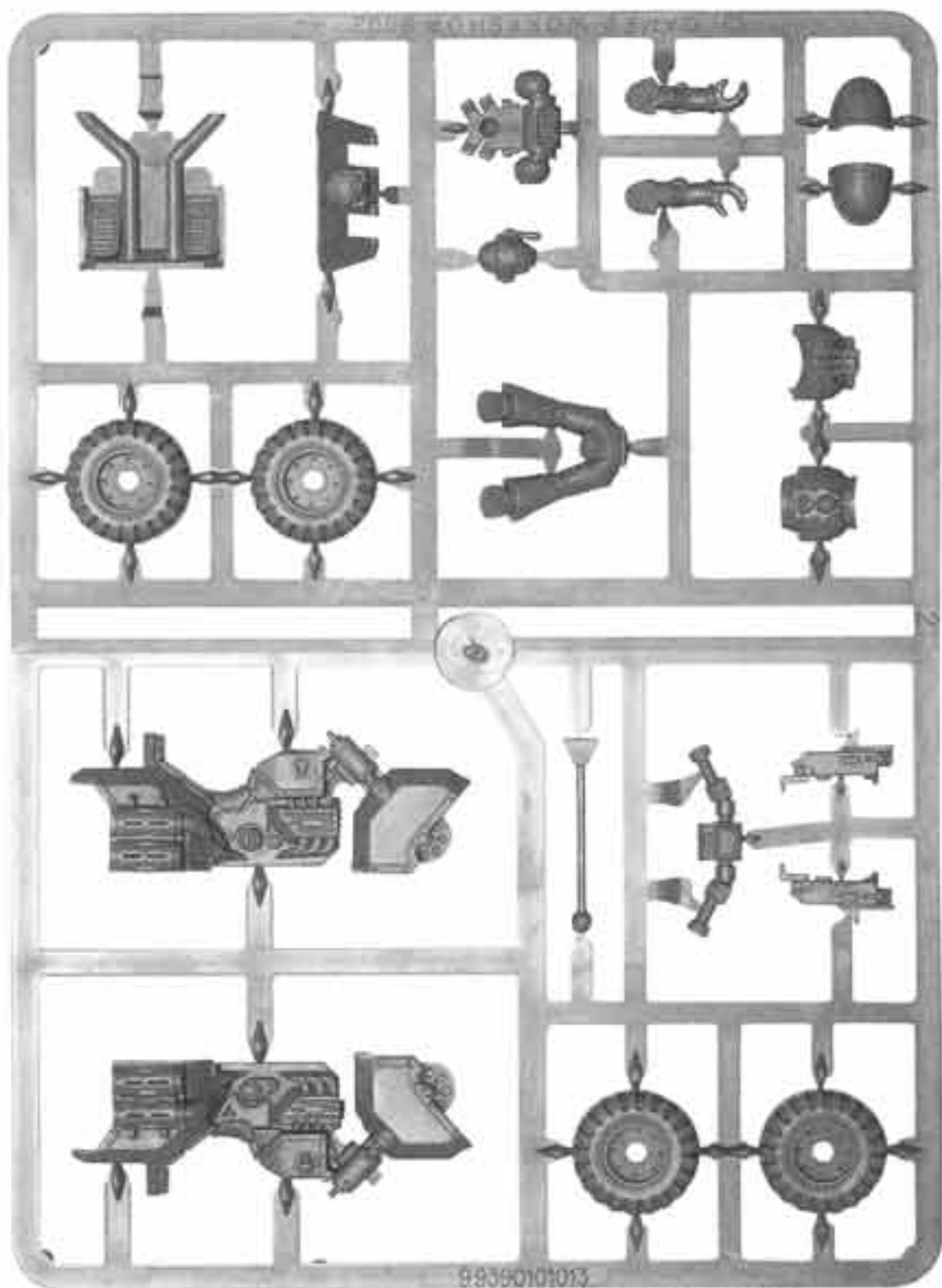

SPACE MARINE BIKE SPRUE (SHOWN 70% ACTUAL SIZE)
AVAILABLE ONLY IN BOXED SET

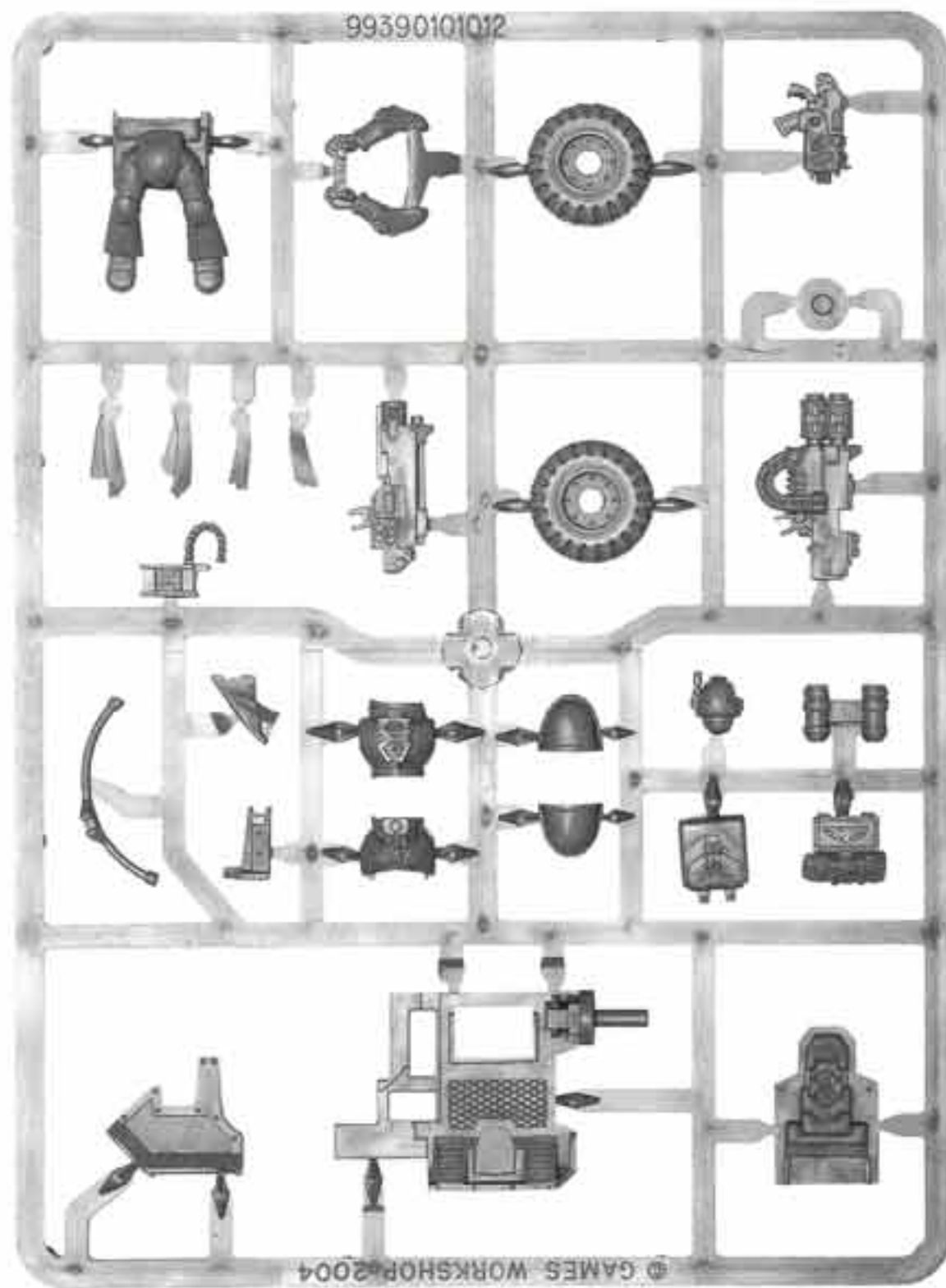

SPACE MARINE ATTACK BIKE SPRUE (SHOWN 70% ACTUAL SIZE)
AVAILABLE ONLY IN BOXED SET

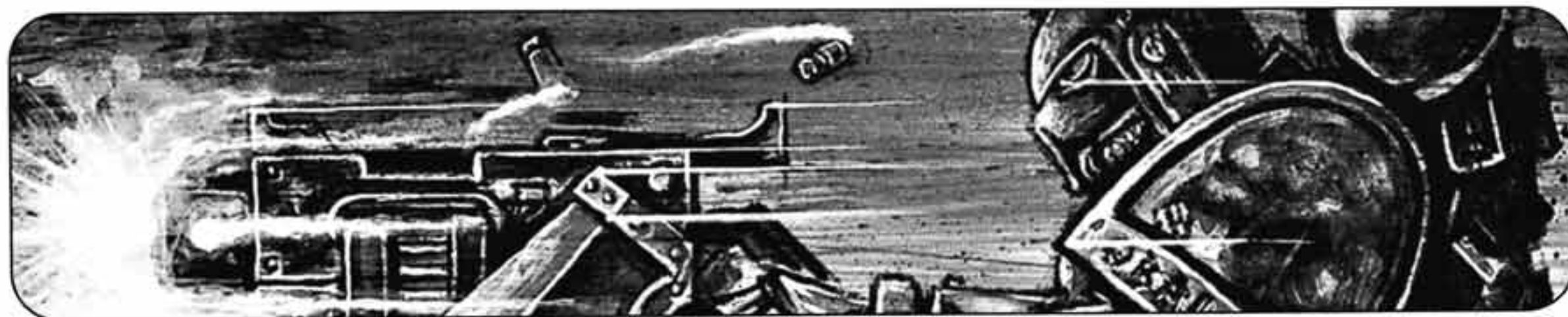



FAST ATTACK



All of the bitz on this page are only available via special offer.



Space Marine Bike Extras Available Only as Bitz

The Space Marine Bikes use the Space Marine Bike sprue (99120101002) and the bitz shown here.



SPACE MARINE SERGEANT BIKER
9947010105601



MARINE BIKER W/ PLASMA GUN
9947010105602



MARINE BIKER W/ MELTA GUN
9947010105603



Space Marine Scout Bike Extras Available Only as Bitz

The Space Marine Scout Bikes use the Space Marine Bike sprue (99120101002) and the bitz shown here.



SCOUT BIKER LEFT ARM
9947010121909



BIKE SCOUT BOLTER/GRENADE LAUNCHER
9947010121908



SCOUT BIKER SHOTGUN
9947010121905

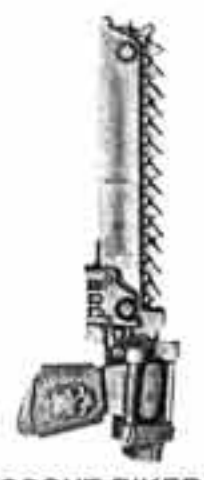

SCOUT BIKER CHAINWORD
9947010121904



SCOUT BIKE HOLSTERS
9947010121907



MARINE BIKE SCOUT BODY 1
9947010121901



MARINE BIKE SCOUT BODY 2
9947010121902



MARINE BIKE SCOUT BODY 3
9947010121903



SCOUT BIKER SADDLEBAG
9947010121908



All of the bitz on this page are only available via special offer.

FAST ATTACK



White Scars Bike Extras Available Only as Bitz

White Scars Bikes use the Space Marine Bike sprue (99120101002) and the bitz shown here.



WHITE SCARS BIKER 1
9947010123401



WHITE SCARS BIKER 2
9947010123402



WHITE SCARS BIKER 3
9947010123403



WHITE SCARS SPRUE
9947010123404

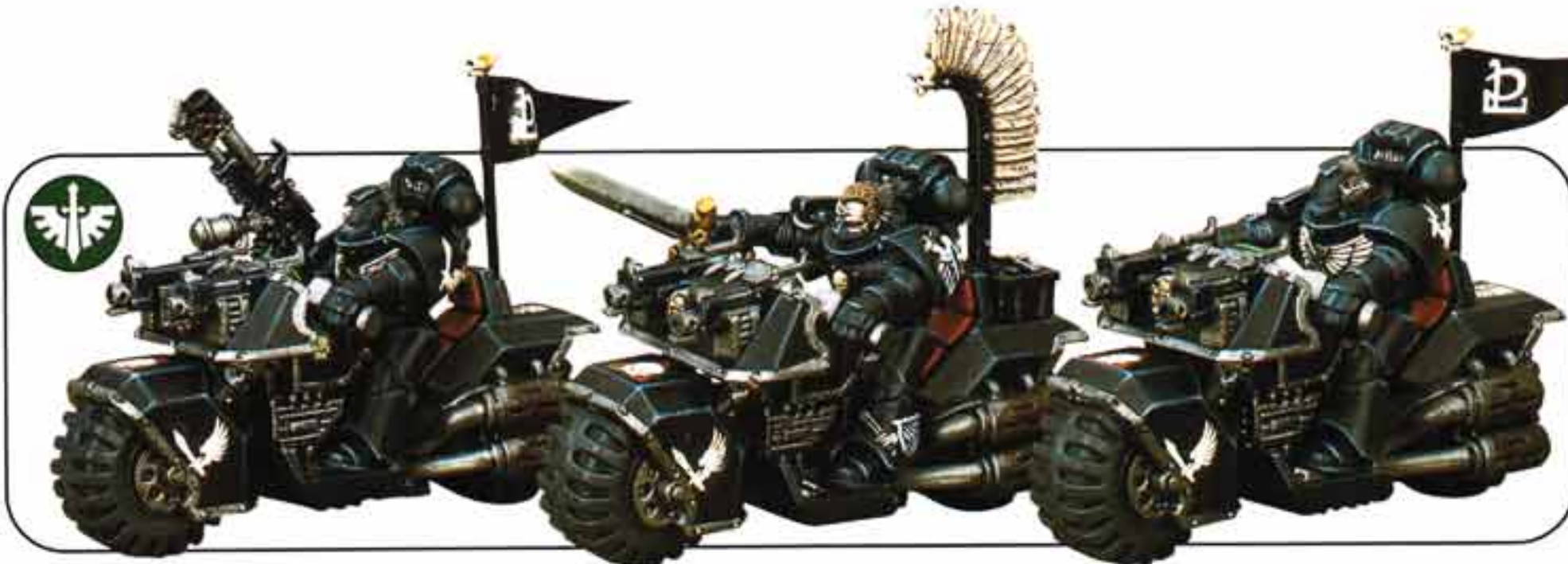

Dark Angels Ravenwing Bike Squadron Available Only as Bitz

Dark Angels Ravenwing Bikes use the Space Marine Bike sprue (99120101002) and the bitz shown here.



RAVENWING SWORD ARM
9947010119304



RAVENWING BIKE AMMO BOX
9947010119309



RAVENWING BIKER TORSO 1
9947010119301



RAVENWING BIKER TORSO 2
9947010119302



RAVENWING BIKER TORSO 3
9947010119303



RAVENWING BIKER LEGS
9947010119306



RAVENWING BACKBANNER
9947010119307



RAVENWING FLAMER ARM
9947010119305



FAST ATTACK

The Space Marine Land Speeder boxed set (99120101005) only contains one Land Speeder. Two are shown here to demonstrate the choice of weaponry available in the box.



Space Marine Land Speeder Box (1)
99120101005

The Space Marine Land Speeder boxed set (99120101005) also includes the Space Marine Vehicle Decal Sheet (99510101104) shown at the end of this section, as well as the Large Flying Base (99379999002), Long Flying Stems sprue (99379999013), and the Ball and Socket sprue (99399999062) shown in the Hobby Supplies section.

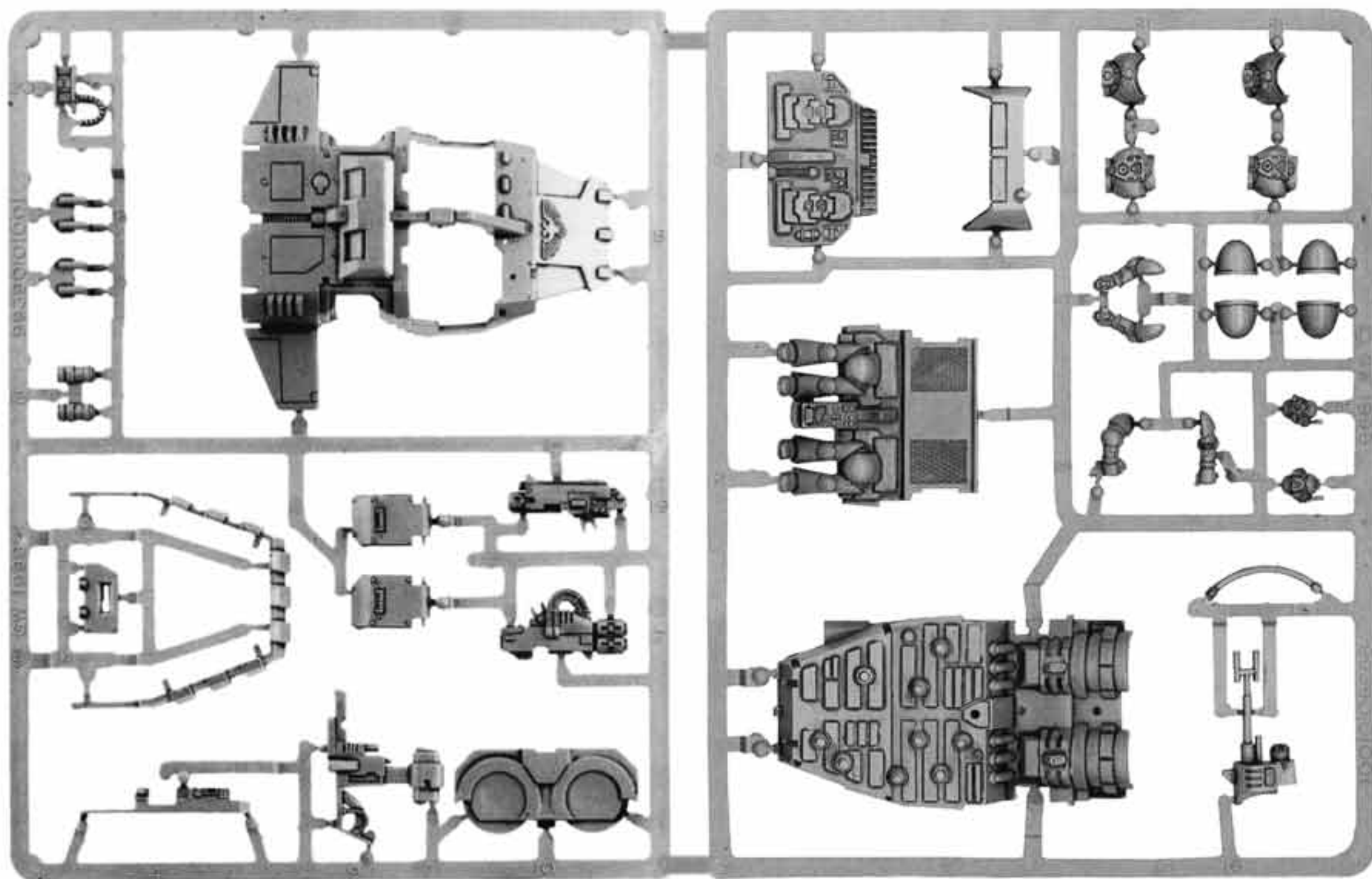

SPACE MARINE LAND SPEEDER SPRUE (SHOWN 65% ACTUAL SIZE)
AVAILABLE ONLY IN BOXED SET

FAST ATTACK



Space Marine Land Speeder Tornado Box (1)
99140101187



TORNADO RANGE FINDER
9947010118703



TORNADO ASSAULT CANNON
9947010118701



TORNADO HEAVY FLAMER
9947010118702



TORNADO STORAGE 1
9947010118704



TORNADO STORAGE 2
9947010118705

The Space Marine Land Speeder Tornado boxed set (99140101187) also includes the Space Marine Land Speeder Sprue (99390101001) shown on the opposite page, the Space Marine Vehicle Decal Sheet (99510101104) shown at the end of this section, and the Large Flying Base (99379999002), Long Flying Stems sprue (99379999013), and the Ball and Socket sprue (99399999062) shown in the Hobby Supply section.

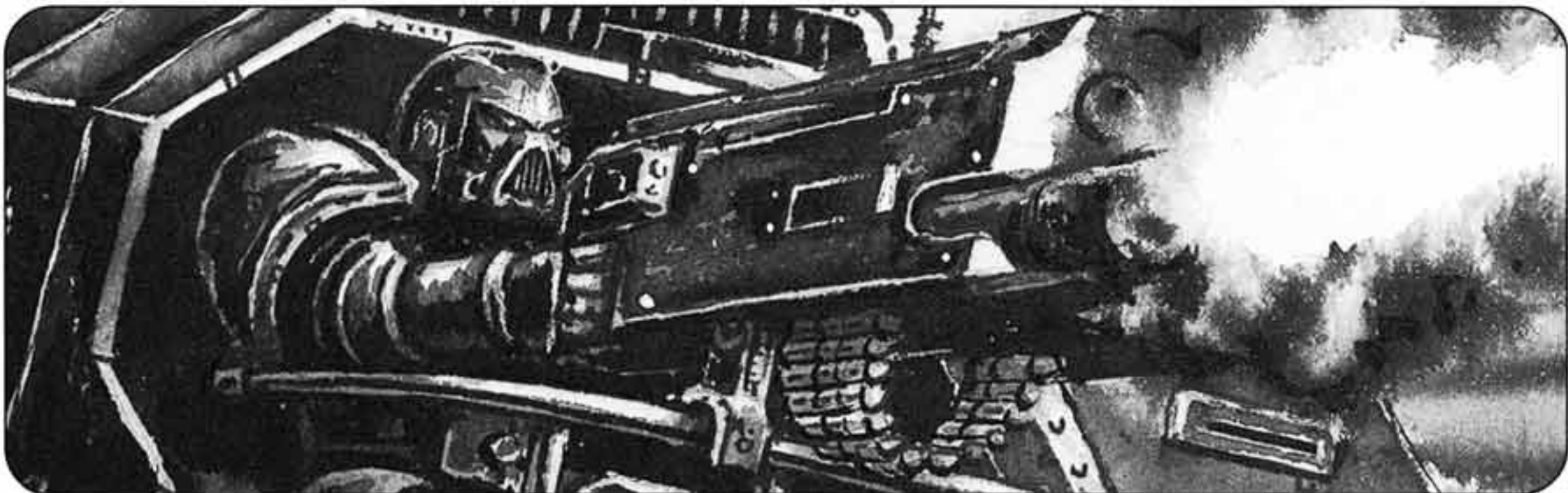

Space Marine Land Speeder Typhoon Box (1)
99140101203



TYPHOON PILOT (FRONT)
9947010120301



TYPHOON MISSILES
9947010120302



TYPHOON LEFT ARM
9947010120303



TYPHOON RIGHT ARM
9947010120304

The Space Marine Land Speeder Typhoon boxed set (99140101203) also includes the Space Marine Land Speeder Sprue (99390101001) shown on the opposite page, the Space Marine Vehicle Decal Sheet (99510101104) shown at the end of this section, and the Large Flying Base (99379999002), Long Flying Stems sprue (99379999013), and the Ball and Socket sprue (99399999062) shown in the Hobby Supply section.



HEAVY SUPPORT



Space Marine Devastators Box (5)
99110101308

Devastator w/ Lascannon Blister (1)
99060101190

Devastator w/ Heavy Bolter Blister (1)
99060101189

Devastator w/ Plasma Cannon Blister (1)
99060101191

The Space Marine Devastators boxed set (99110101308) also contains the Space Marine Tactical Upgrade sprue (99380101025) shown with the Space Marine Tactical Squad and the Space Marine Decal Sheet (99510101102) shown at the end of the Space Marines section.

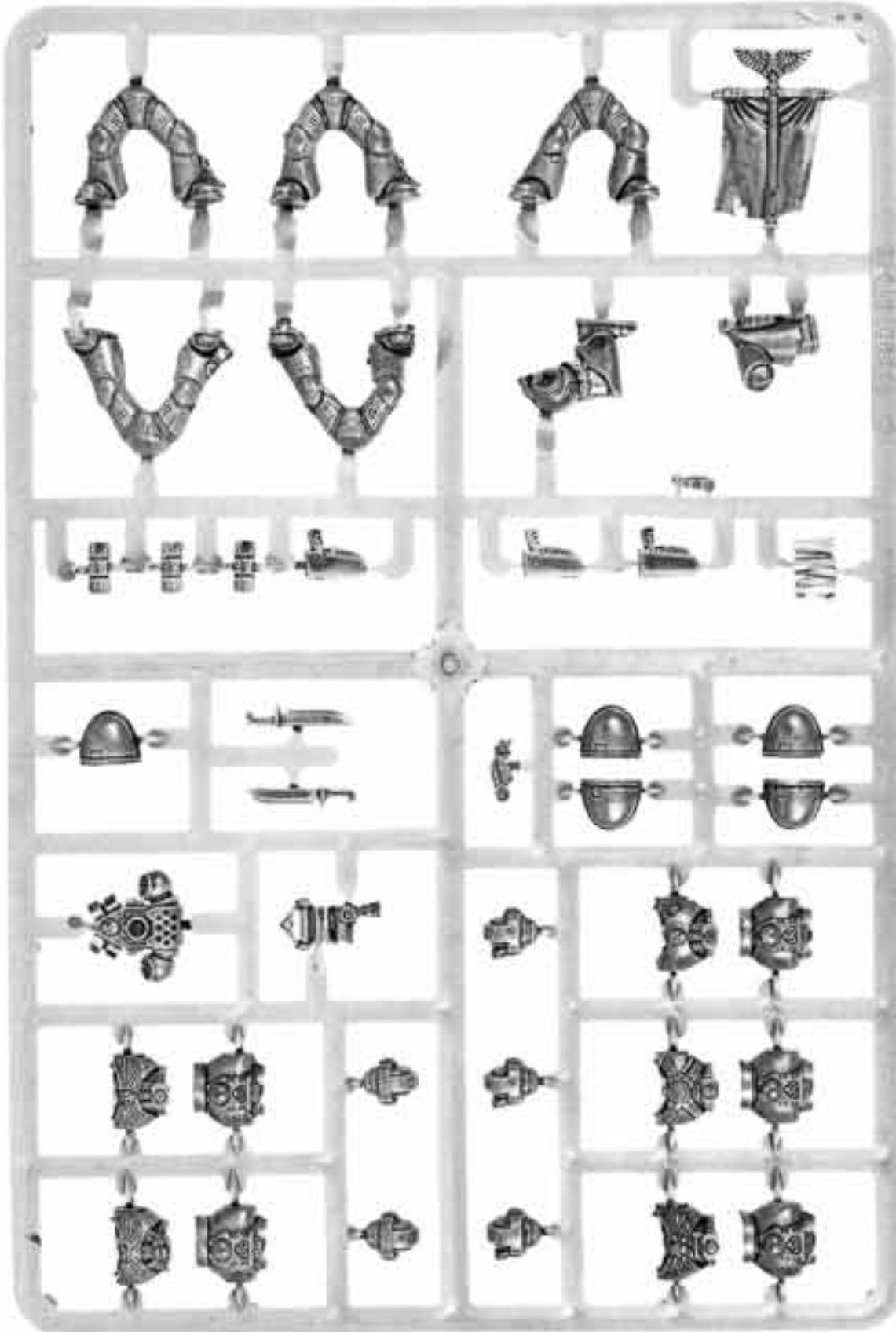

SPACE MARINE COMMAND LEGS SPRUE (SHOWN 70% ACTUAL SIZE)
99380101018



DEVASTATOR SERGEANT ARM
9947010118601



DEVASTATOR MISSILE LAUNCHER BACKPACK
9947010118611



DEVASTATOR HEAVY BOLTER
9947010118602



DEVASTATOR HEAVY BOLTER ARM
9947010118603



DEVASTATOR HEAVY BOLTER BACKPACK
9947010118604

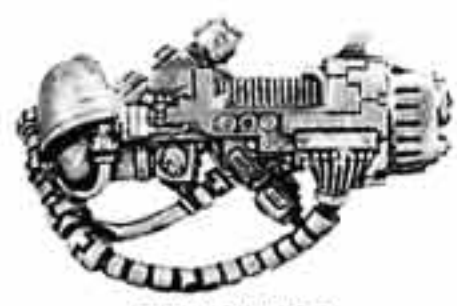

DEVASTATOR PLASMA CANNON
9947010118605



DEVASTATOR PLASMA CANNON ARM
9947010118606



DEVASTATOR PLASMA CANNON BACKPACK
9947010118607



DEVASTATOR LASCANNON
9947010118608



DEVASTATOR LASCANNON ARM & SIGHT
9947010118609



DEVASTATOR LASCANNON BACKPACK
9947010118610

All dimensions are supplied unprimed. Models, bits, and sprues are all shown actual size unless otherwise noted. Contents may vary slightly from those shown.

HEAVY SUPPORT



Devastator w/ Multi Melta Blister (1)
99060101218

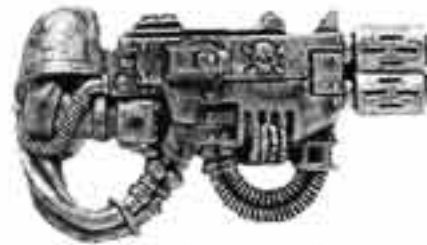

SPACE MARINE MULTI MELTA
9947010121401



MULTI MELTA ARM
9947010121402



MULTI MELTA BACKPACK
9947010121403



The Space Wolf Long Fangs boxed set (99110101214) contains bitz 9947010118602–10 from the Space Marine Devastators boxed set (99110101308) and the metal bitz from the Devastator with Multi Melta blister (99060101218), shown on these pages.



Space Wolf Long Fangs Box (5)
99110101214



These bitz are available only via special offer. The completed models are shown here as examples only.



L.O.D. HEAVY BOLTER
9947010109603



L.O.D. MISSILE LAUNCHER
9947010110007



L.O.D. LASCANNON
9947010110005



L.O.D. DEVASTATOR BODY 1
9947010109602

Legion of the Damned Devastators
Only Available as Bitz



HEAVY SUPPORT



Space Marine Land Raider Box (1)
99120101010

The Space Marine Land Raider boxed set (99120101010) also contains the Space Marine Decal Sheet (99510101102) shown at the end of the Space Marines section.

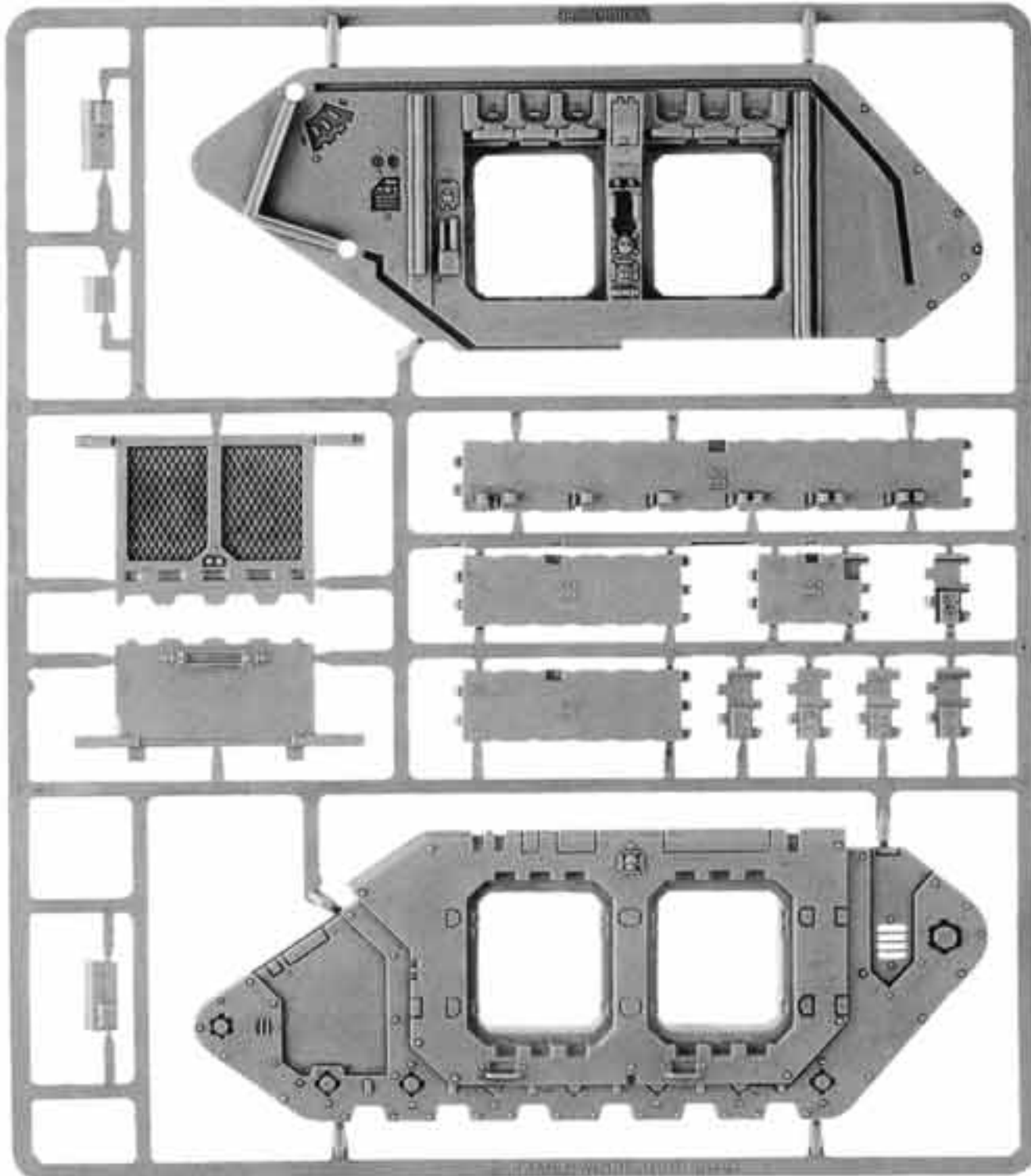

LAND RAIDER LEFT TRACK SPRUE (SHOWN 50% ACTUAL SIZE)
AVAILABLE ONLY IN BOXED SET

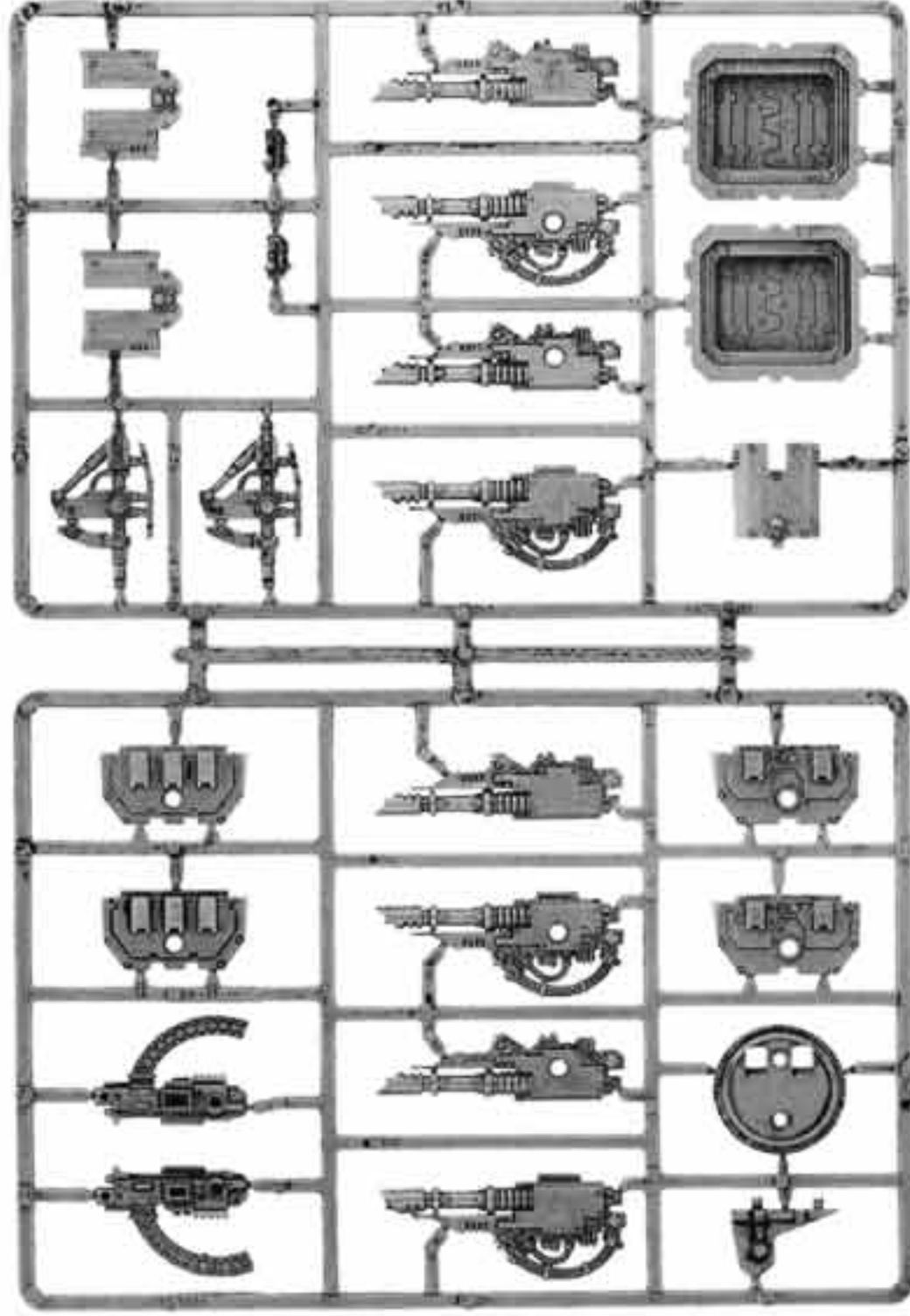

LAND RAIDER SPONSON SPRUE B (SHOWN 50% ACTUAL SIZE)
99390101003

All illustrations are supplied unpainted. Models, kits, and sprues are all shown at actual size unless otherwise noted. Contents may vary slightly from those shown.

HEAVY SUPPORT

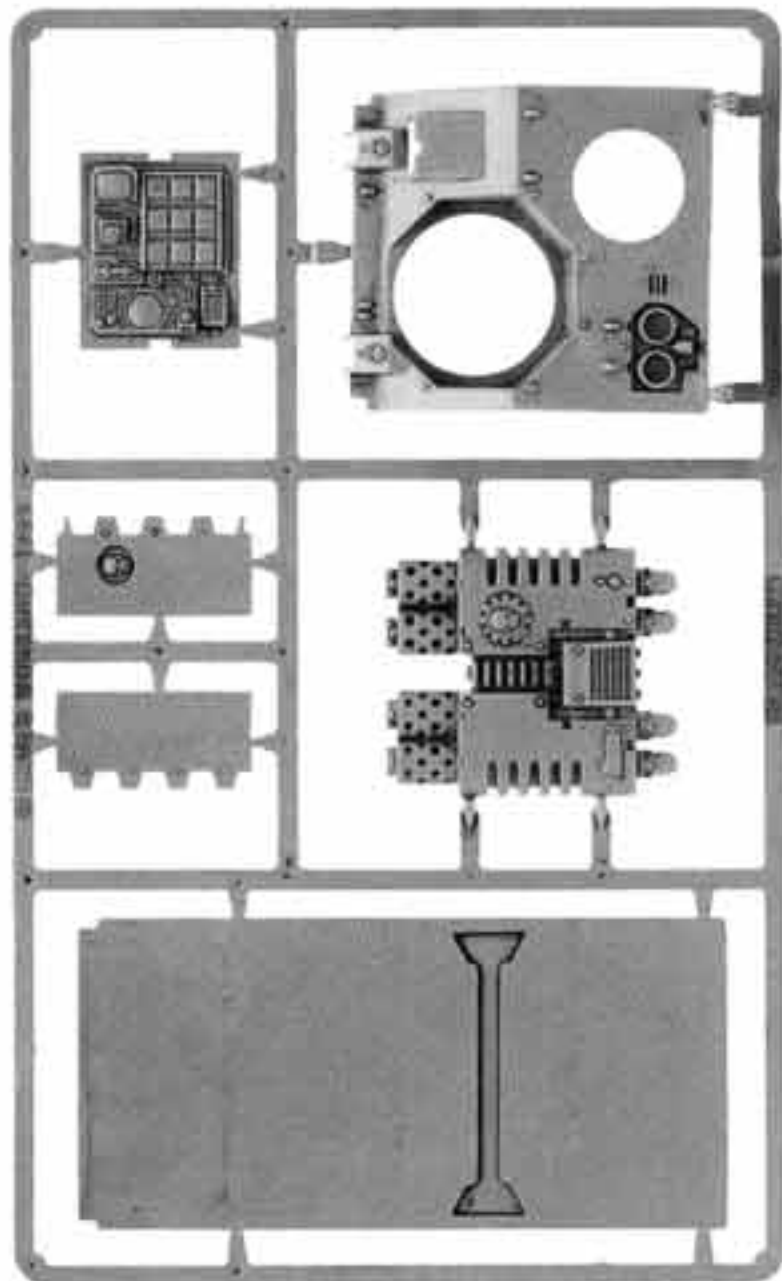

LAND RAIDER FLOOR SPRUE (SHOWN 50% ACTUAL SIZE)
AVAILABLE ONLY IN BOXED SET

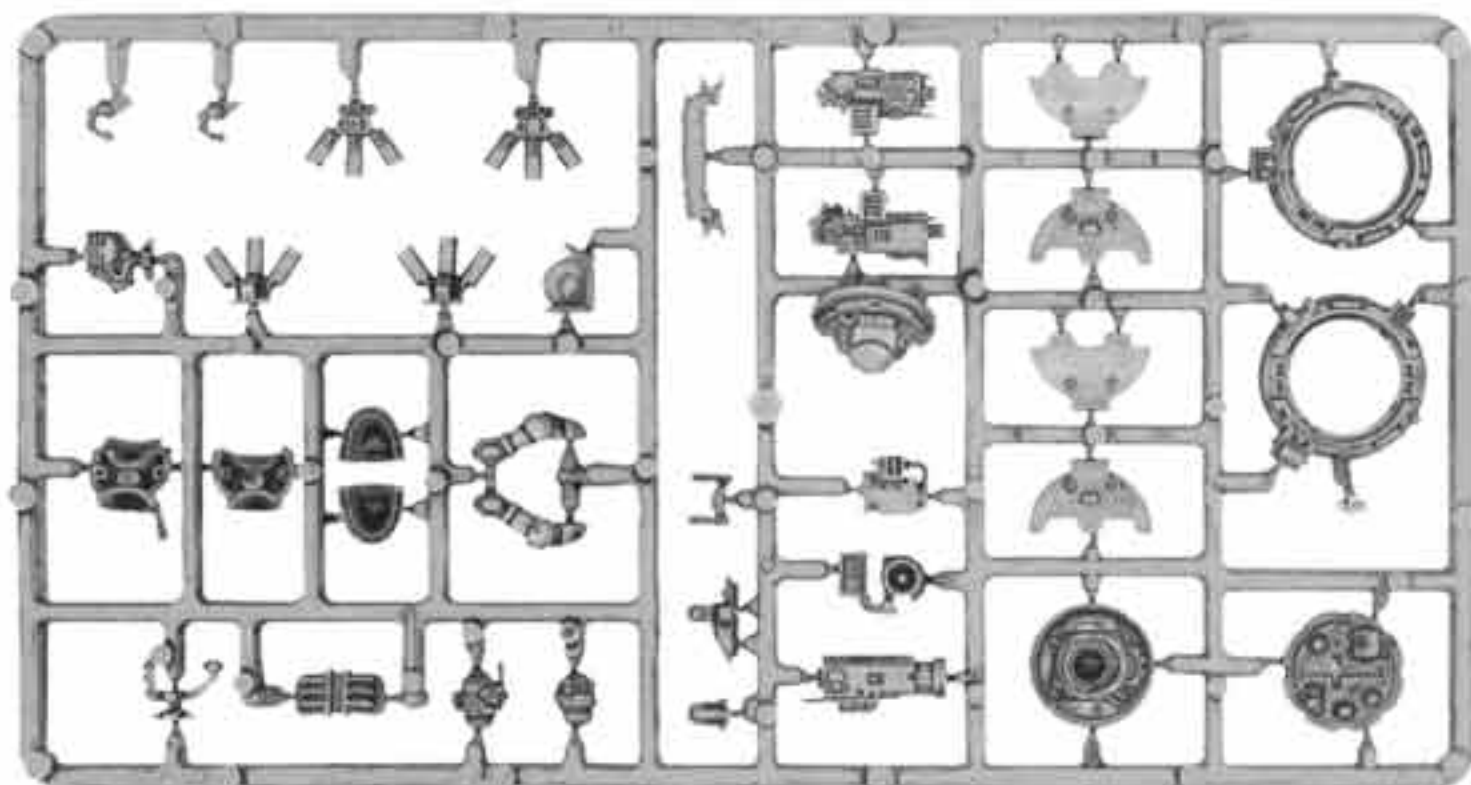

LAND RAIDER ACCESSORY SPRUE (SHOWN 60% ACTUAL SIZE)
99390101004

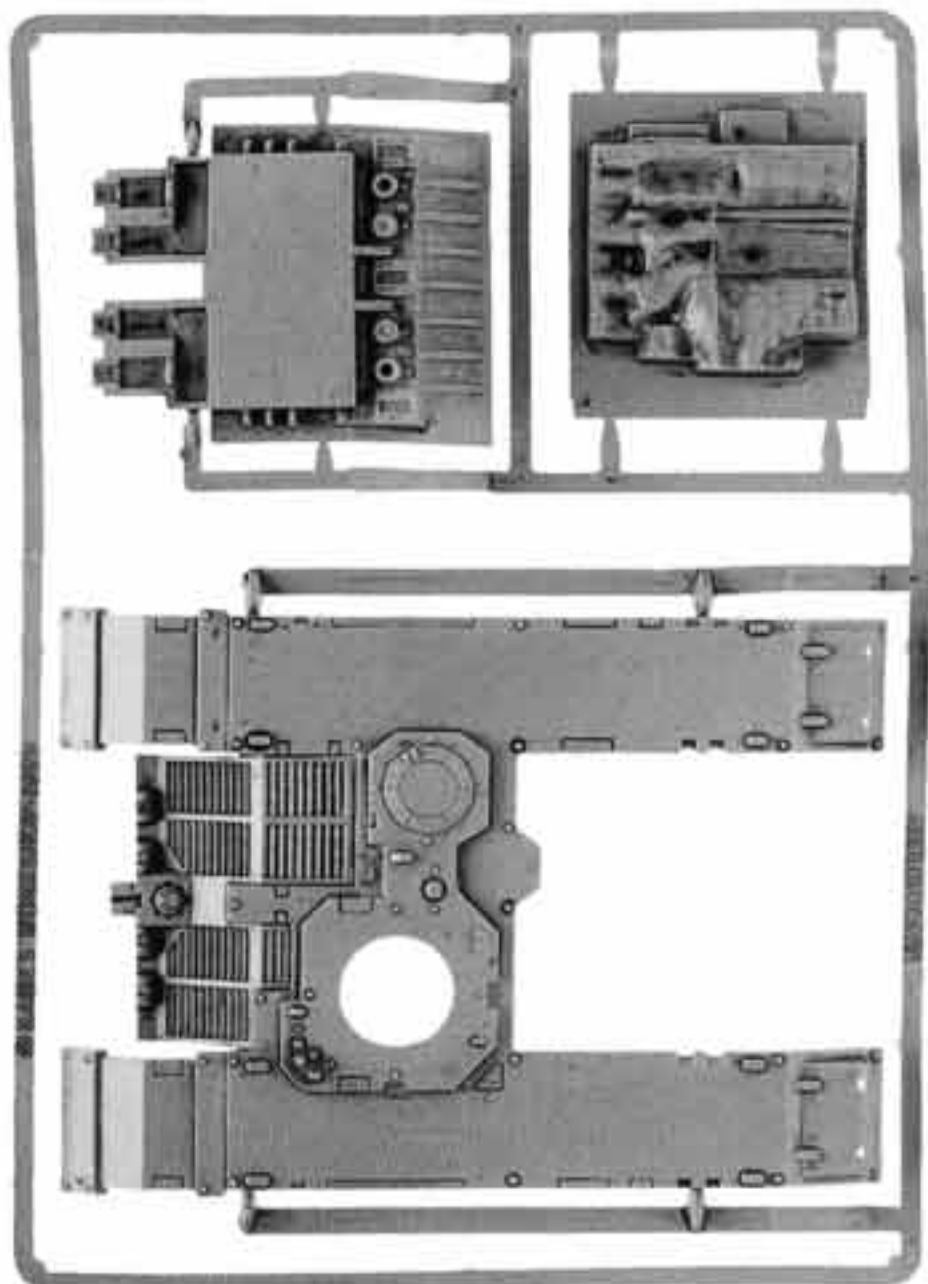

LAND RAIDER TOP SPRUE (SHOWN 50% ACTUAL SIZE)
AVAILABLE ONLY IN BOXED SET

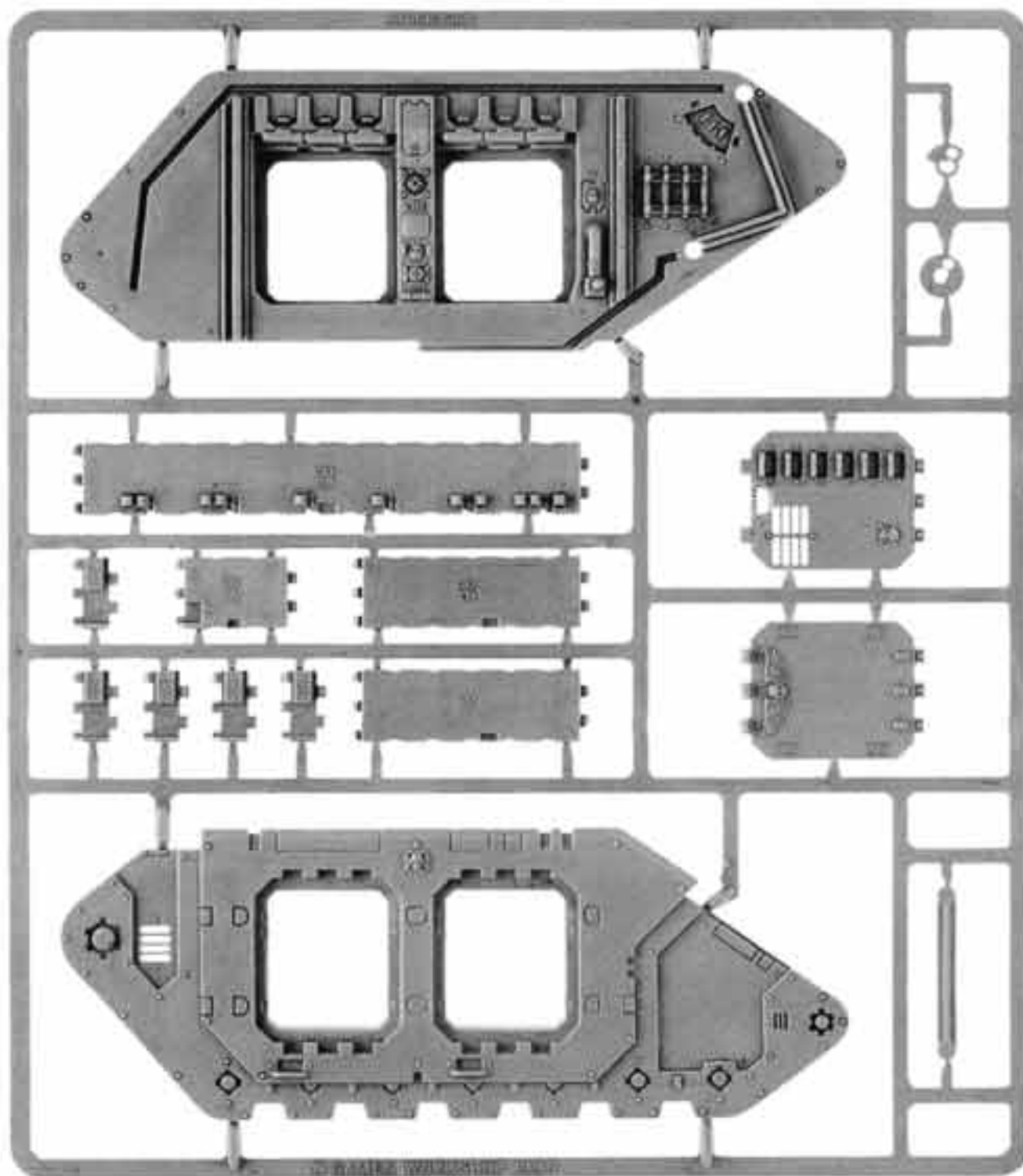

LAND RAIDER LEFT TRACK SPRUE (SHOWN 50% ACTUAL SIZE)
AVAILABLE ONLY IN BOXED SET



HEAVY SUPPORT

The Land Raider Crusader is shown at 80% of actual size.



Land Raider Crusader Box (1)
99140101217

SQUAD BADGES

The different types of squads in a Space Marine Company (e.g., Tactical, Devastator, and Assault) are often distinguished by badges and markings on the shoulder pad or elsewhere. Some Companies also use numbers to separate the troops when more than one squad of the same type is in the same Company. Markings generally adhere to a common visual theme, but there are many variants when it comes to marking individual squads. Here are some examples of squad badges.

TACTICAL SQUADS



HQ SQUADS



ASSAULT SQUADS



VETERANS SQUADS



HEAVY SUPPORT SQUADS



SQUAD NUMERALS



CRUSADER FRAG. ASSAULT LAUNCHERS
9947010121702

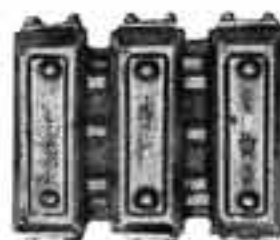

HURRICANE AMMO BOXES
9947010121703



CRUSADER MELTA SHIELD LEFT
9947010121706



CRUSADER MELTA SHIELD RIGHT
9947010121705



CRUSADER MULTI MELTA
9947010121710

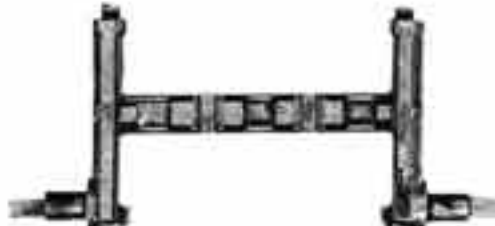

CRUSADER HURRICANE MOUNTS
9947010121711



HURRICANE AMMO FEEDS
9947010121704

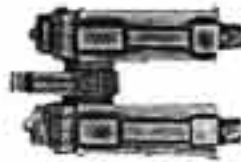

CRUSADER HURRICANE BOLTERS
9947010121709



CRUSADER LEFT ASSAULT CANNON
9947010121707



CRUSADER RIGHT ASSAULT CANNON
9947010121708



CRUSADER SPONSON SIDES
9947010121701

The Land Raider Crusader boxed set (99140101217) contains all of the sprues shown with the Land Raider boxed set (99120101010) shown on the previous pages as well as the Space Marines Vehicle decal sheet (99510101104) shown at the end of this section.

HEAVY SUPPORT



The Space Marine Predator boxed set (99120101016) also includes all of the sprues listed with the Space Marine Rhino boxed set (99120101017).

Space Marine Predator Box (1)
99120101016

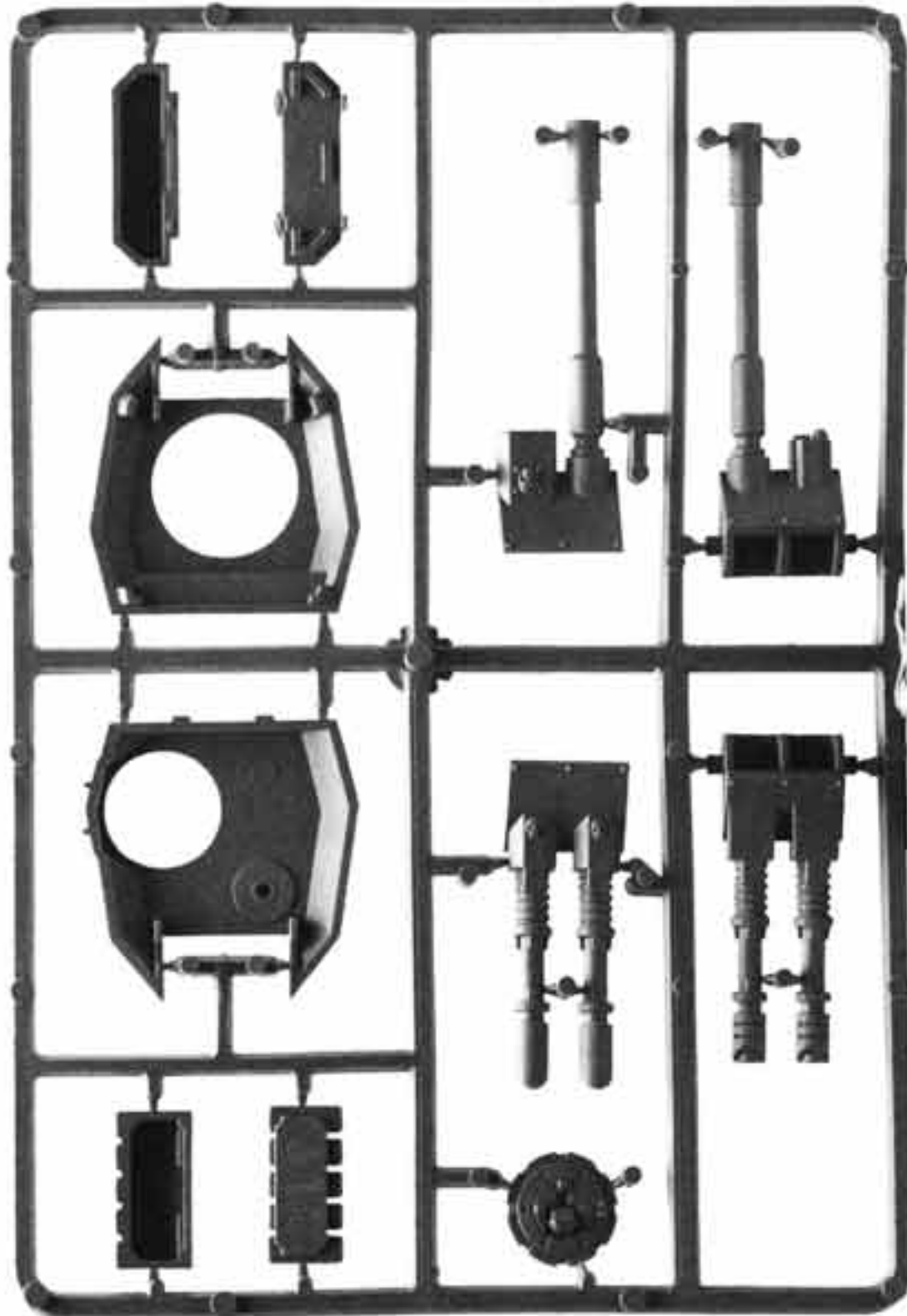

PREDATOR TURRET SPRUE (SHOWN 50% ACTUAL SIZE)
99390199007

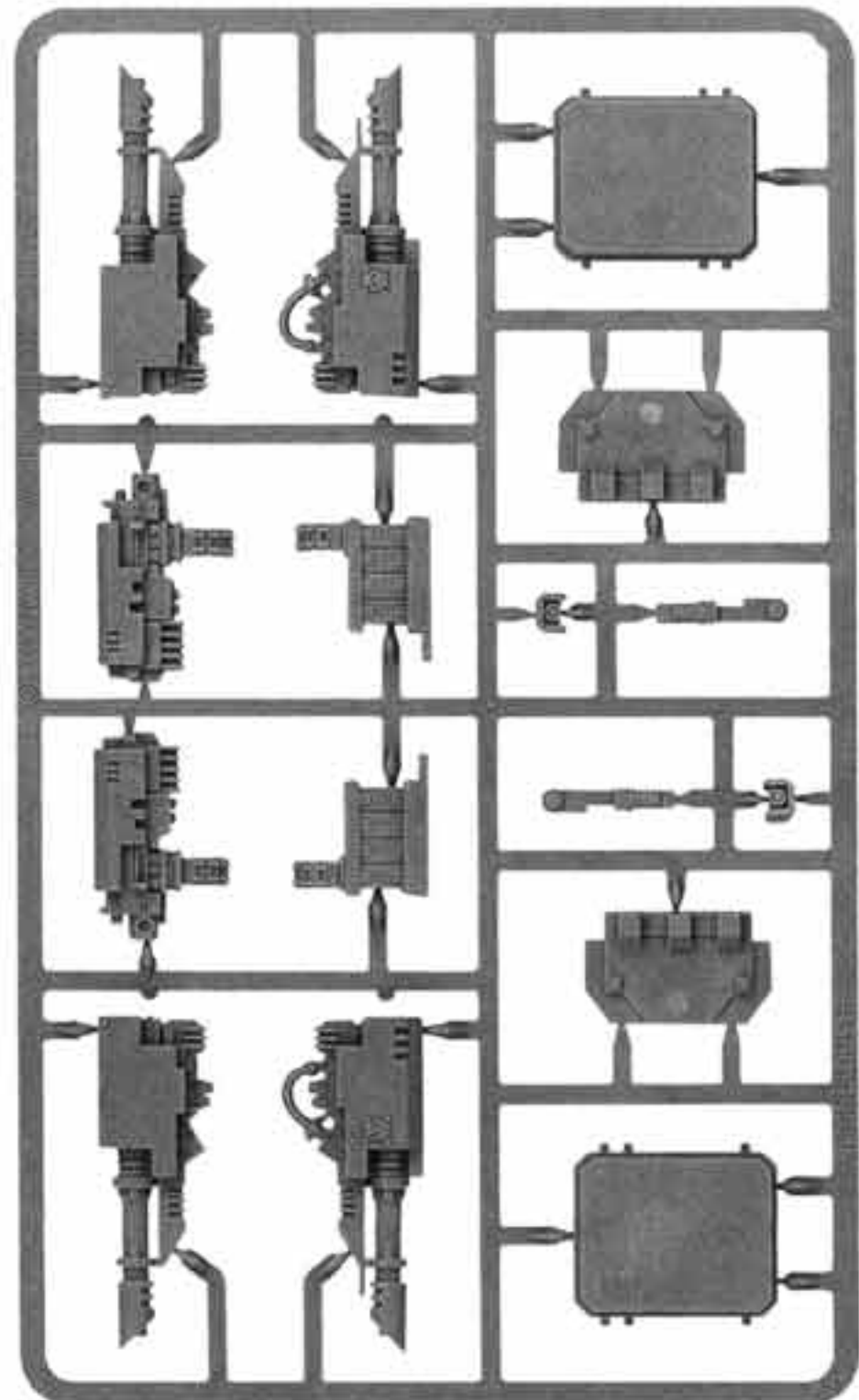

PREDATOR SPONSON SPRUE (SHOWN 50% ACTUAL SIZE)
99390199008



HEAVY SUPPORT



Space Marine Whirlwind Box (1)
99120101031

The Space Marine Whirlwind boxed set (99120101031) also contains the sprues shown with Space Marine Rhino boxed set (99120101017) shown in the troops section as well as the Space Marines Vehicle Decal Sheet (99510101104) shown at the end of the Space Marines section.

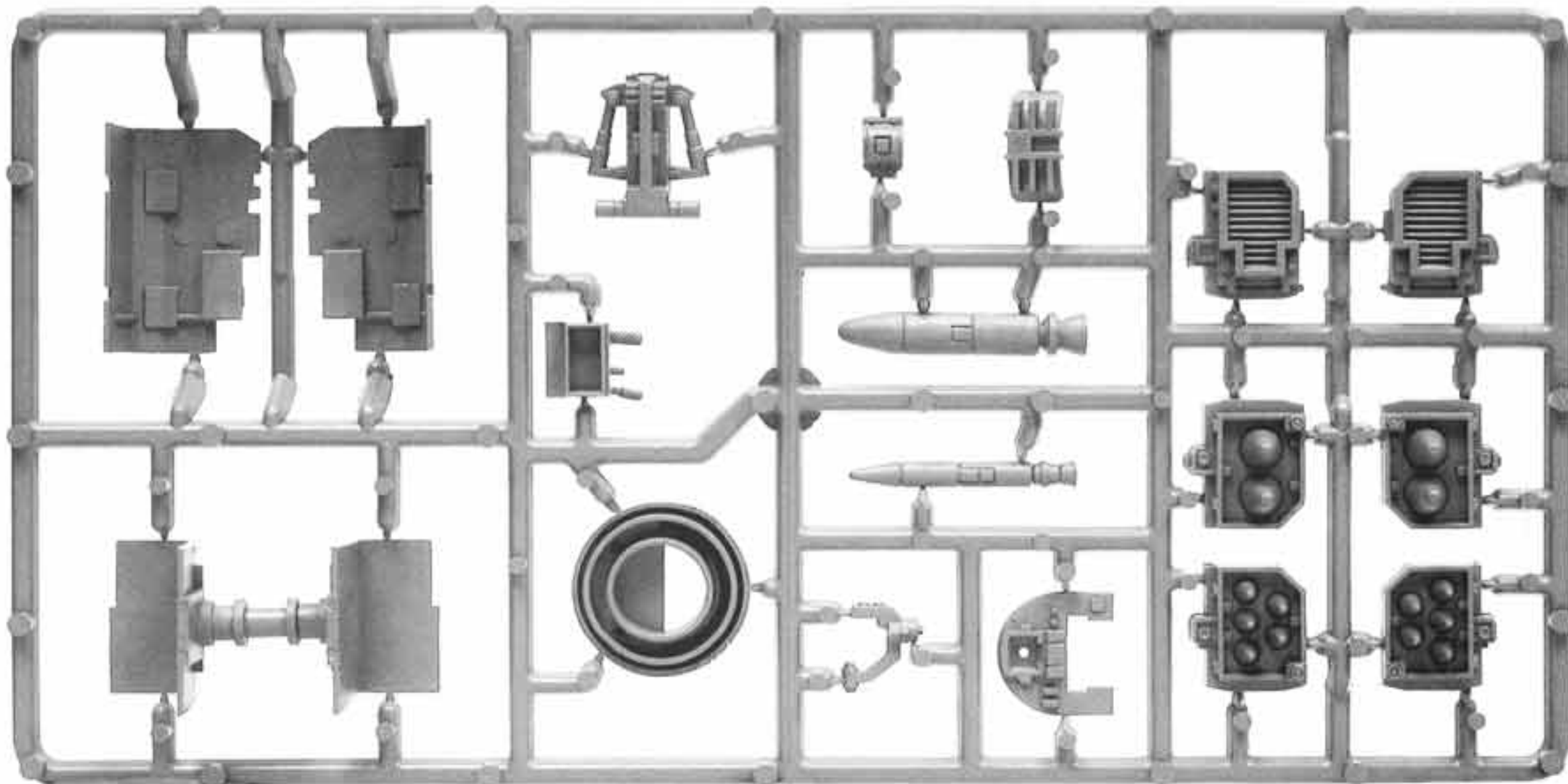

PREDATOR TURRET SPRUE (SHOWN 75% ACTUAL SIZE)
99390199010



The bitz for this model are available only via special offer.

HEAVY SUPPORT

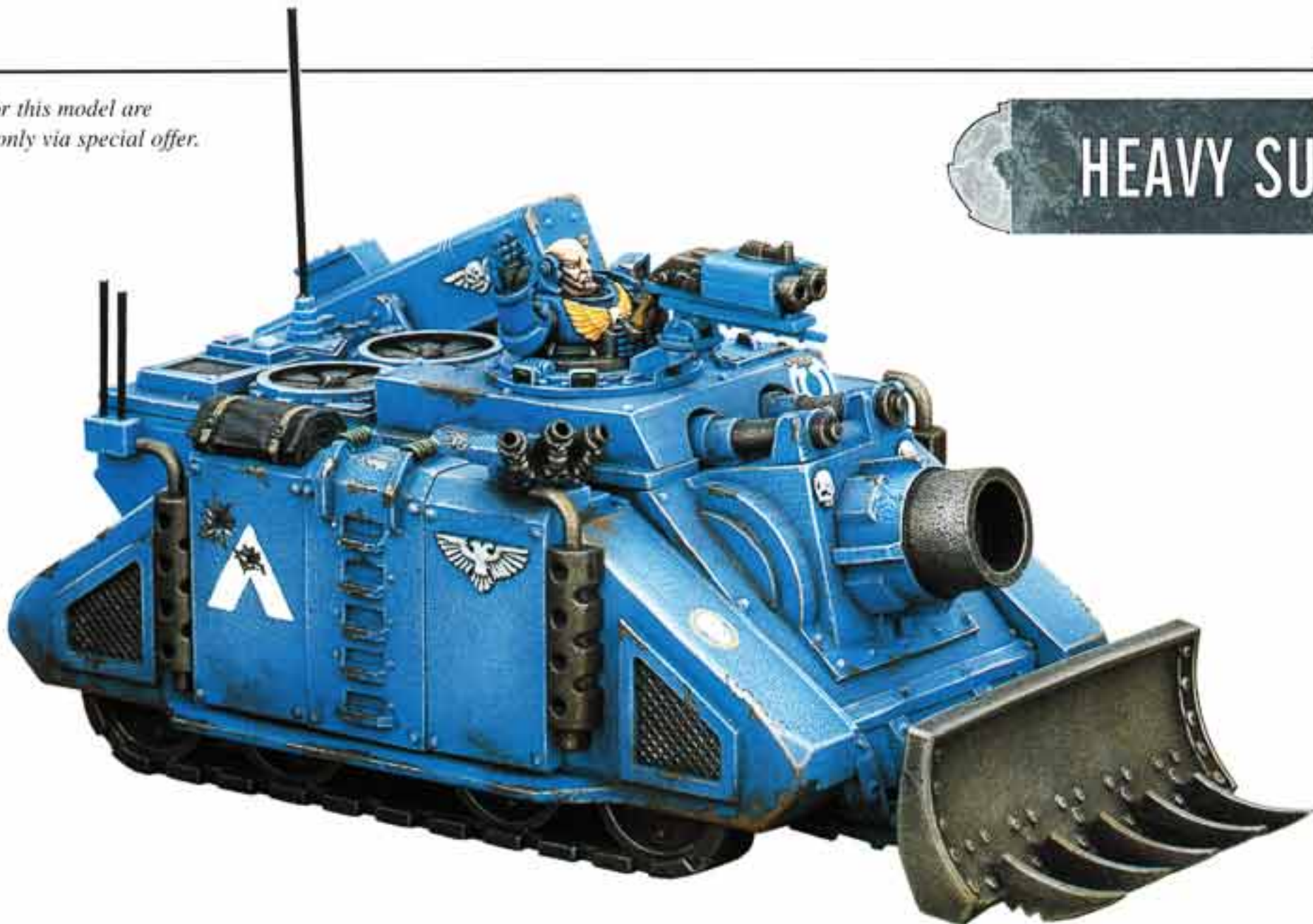

Classic Space Marine Vindicator Box (1)
99140101114

Several bitz are included in this kit that are not available separately and are not shown here.

The metal bitz on this page were designed for use with the classic Rhino chassis sprues shown on this page. A small amount of conversion work is necessary to fit the bitz to the current Rhino chassis contained in the Space Marine Rhino boxed set (99120101017).

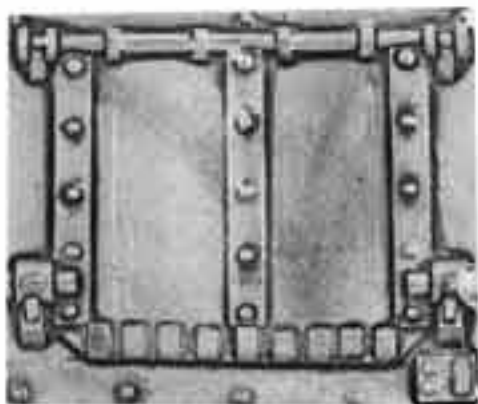

VINDICATOR REAR HATCHES
9947010111411



VINDICATOR SCANNER
9947010111414



VINDICATOR DEMOLISHER CANNON
9947010111413



VINDICATOR FRONT PLATE
9947010111410



VINDICATOR MARINE TANK COMMANDER
9947010111412

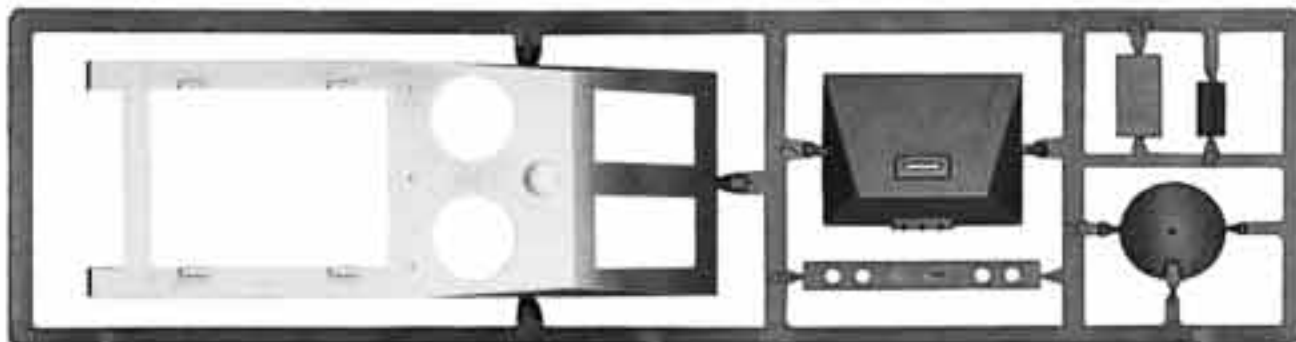

CLASSIC RHINO CHASSIS SPRUE (SHOWN 50% ACTUAL SIZE)
AVAILABLE ONLY IN BOXED SET

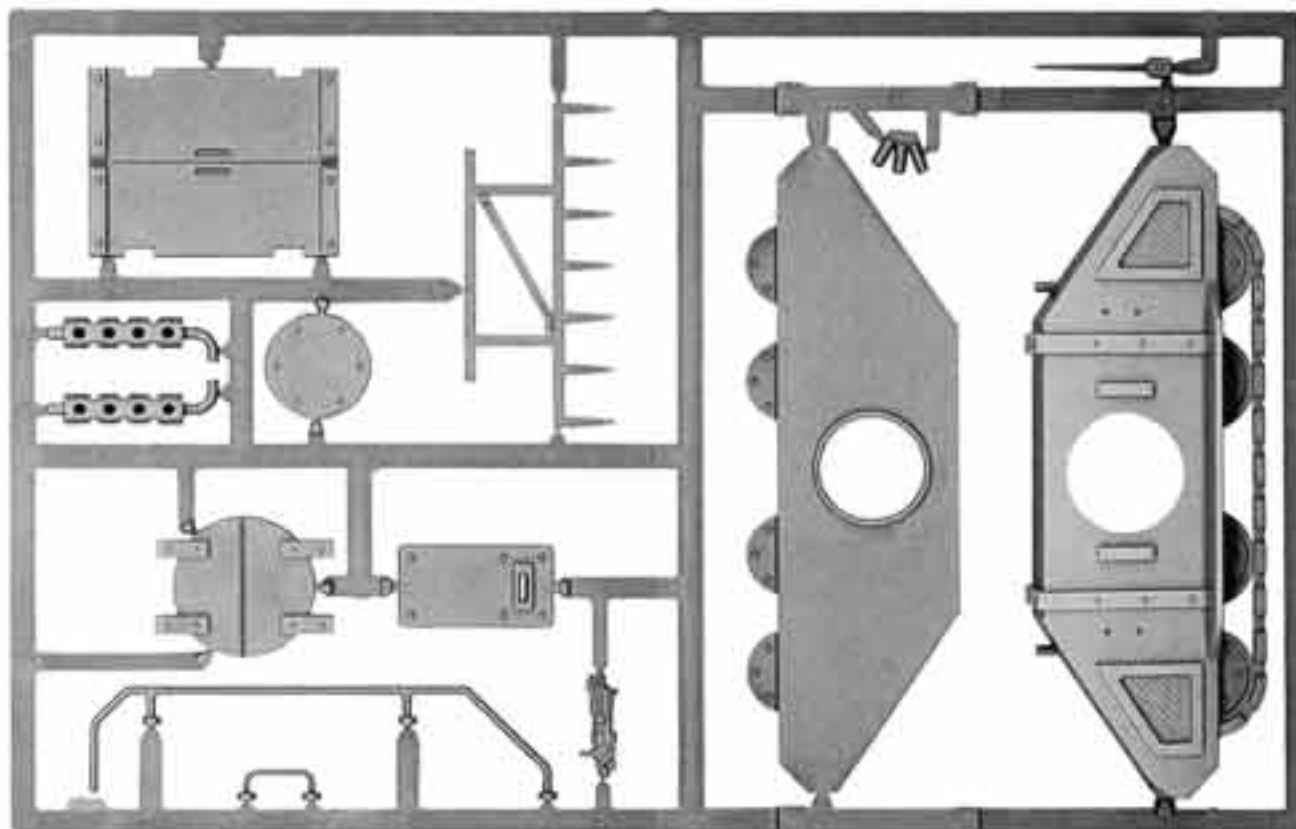

CLASSIC RHINO TRACK SPRUE (SHOWN 50% ACTUAL SIZE)
AVAILABLE ONLY IN BOXED SET



HEAVY SUPPORT

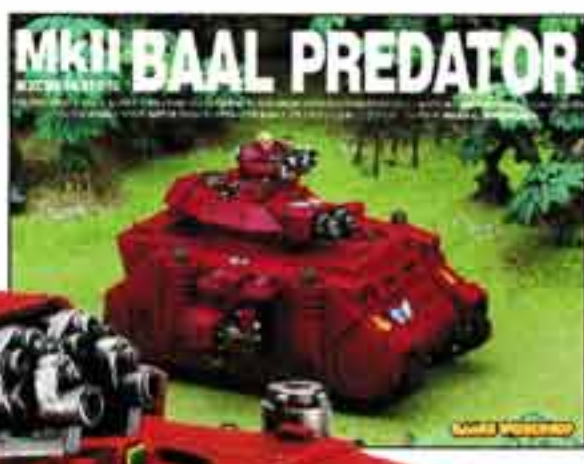

PAINTING SPACE MARINE EYES

Below, we show you three ways to paint the eyes on your Space Marine models to contrast with color of their helmets.

RED HELMET



- Paint eye with Chaos Black (not shown)
1. With a fine detail brush, paint the eye with slightly thinned Snot Green. Take care to leave a thin black line between the eye and the helmet.
 2. Highlight the bottom half of the eye with a mix of equal parts Snot Green and Bad Moon Yellow.
 3. Highlight the very bottom of the eye by carefully painting a line of thinned Snot Green and more Bad Moon Yellow.
 4. Paint a tiny dot of Skull White at the back of the eye to create the effect of sunlight hitting the eye.

GREEN HELMET



- Paint eye with Chaos Black (not shown).
1. With a fine detail brush, paint the eye with slightly thinned Golden Yellow. Take care to leave a thin black line between the eye and the helmet.
 2. Highlight the bottom half of the eye with Bad Moon Yellow.
 3. Highlight the very bottom by carefully painting a line of thinned Skull White.
 4. Paint a tiny dot of Skull White at the back of the eye to create the effect of sunlight hitting the eye.

BLUE HELMET



- Paint eye with Chaos Black (not shown).
1. With a fine detail brush, paint the eye with slightly thinned Blood Red. Take care to leave a thin black line between the eye and the helmet.
 2. Highlight the bottom half of the eye with a mix of Blood Red and Bad Moon Yellow.
 3. Highlight the very bottom of the eye by carefully painting a line of thinned Bad Moon Yellow.
 4. Paint a tiny dot of Skull White at the back of the eye to create the effect of sunlight hitting the eye.



Blood Angels Baal Predator Box (1)
99140101239

The Blood Angels Baal Predator boxed set (99140101239) also contains the sprues shown with the Space Marine Predator boxed set (99120101016) and the Space Marine Rhino boxed set (99120101017), both shown earlier in the section, as well as the Space Marines Vehicle Decal Sheet (99510101104) shown at the end of the Space Marines section.



BAAL PREDATOR WEAPON SHIELD
9947010123902



BAAL PREDATOR ASSAULT CANNON BARRELS
9947010123903



BAAL PREDATOR COMMANDER SPRUE
9947010123901

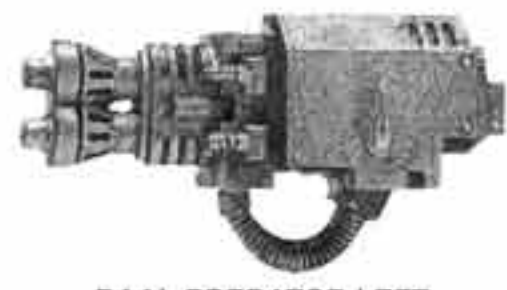

BAAL PREDATOR LEFT HEAVY FLAMER
9947010123904



BAAL PREDATOR RIGHT HEAVY FLAMER
9947010123905



BAAL PREDATOR FLAMER FUEL CELL
9947010123906



BAAL PREDATOR WEAPON SUPPORT
9947010123907



BAAL PREDATOR REAR TURRET
9947010123908



BAAL PREDATOR ARMOR PLATE
9947010123909

All miniatures are supplied unpainted. Models, sets, and sprues are all shown actual size unless otherwise noted. Contents may vary slightly from those shown.

SPACE MARINE VEHICLE TRANSFER SHEET
© & COMPONENT NUMBER 99 51 01 01 104



SPACE MARINES VEHICLE DECAL SHEET
99510101104



SPACE WOLVES DECAL SHEET (SHOWN 65% ACTUAL SIZE)
99510101103

DECAL SHEETS

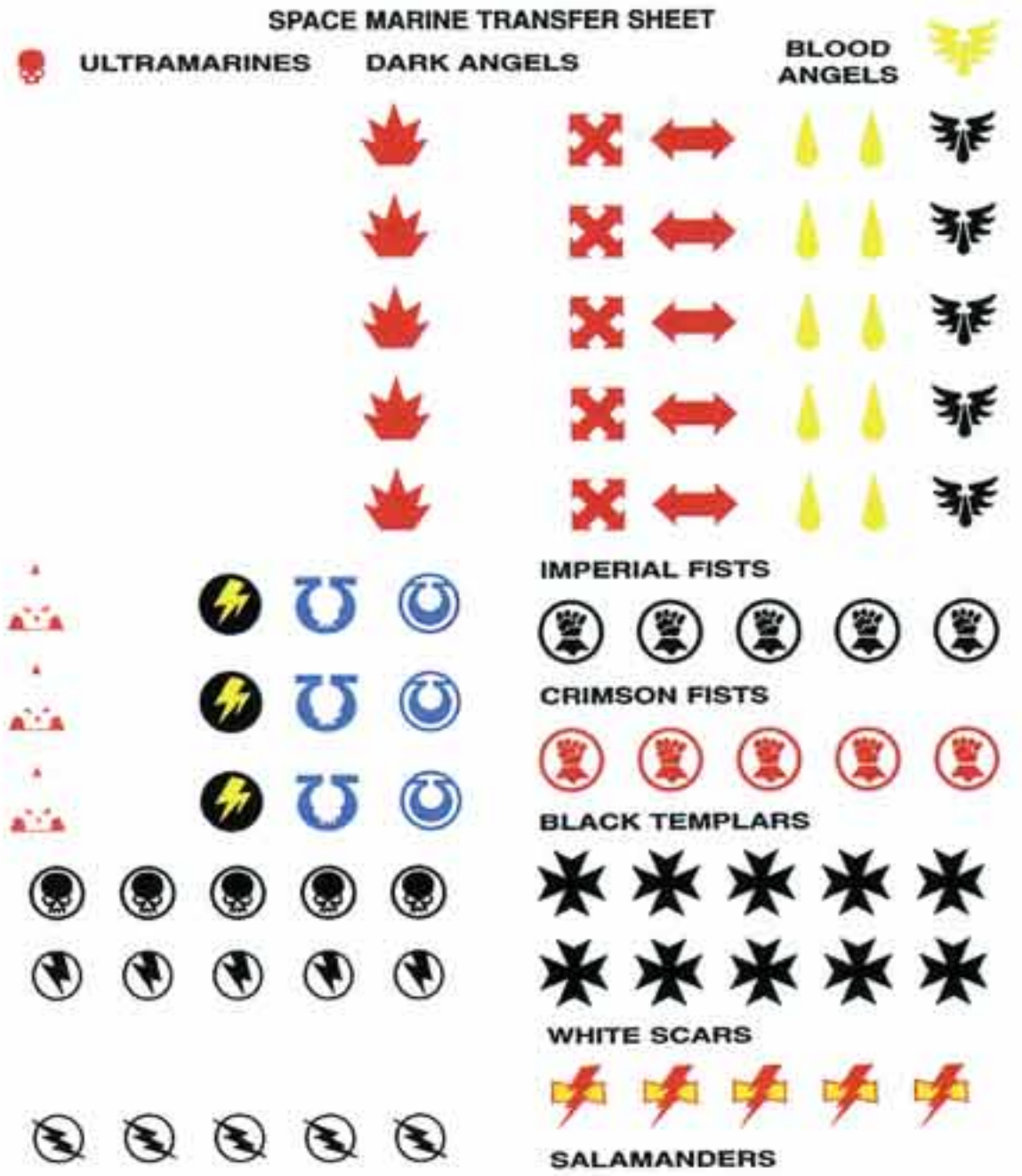

© & COMPONENT NUMBER 99 51 01 01 102

SPACE MARINES DECAL SHEET
99510101102



SHOULDER PADS



TACTICAL SQUAD SHOULDER PAD SPRUE 1
9947010132272



TACTICAL SQUAD SHOULDER PAD SPRUE 2
9947010132273



TACTICAL SQUAD SHOULDER PAD SPRUE 3
9947010132274



ASSAULT SQUAD SHOULDER PAD SPRUE 1
9947010132244



ASSAULT SQUAD SHOULDER PAD SPRUE 2
9947010132245



DEVASTATOR SQUAD SHOULDER PAD SPRUE 1
9947010132256



DEVASTATOR SQUAD SHOULDER PAD SPRUE 2
9947010132257



VETERAN SHOULDER PAD SPRUE 1
9947010132278



VETERANS SHOULDER PAD SPRUE 2
9947010132279



TERMINATOR HONORS SHOULDER PAD SPRUE
9947010132275



DEATHWATCH SHOULDER PAD SPRUE
9947010132254



BLACK TEMPLARS SHOULDER PAD SPRUE 1
9947010132246



BLACK TEMPLARS SHOULDER PAD SPRUE 2
9947010132247



BLOOD ANGELS SHOULDER PAD SPRUE 1
9947010132248



BLOOD ANGELS SHOULDER PAD SPRUE 2
9947010132249



BLOOD ANGELS SHOULDER PAD SPRUE 3
9947010132250



BLOOD ANGELS SHOULDER PAD SPRUE 4
9947010132251



FLESH TEARERS SHOULDER PAD SPRUE
9947010132259



DARK ANGELS SHOULDER PAD SPRUE
9947010132252



DEATHWING SHOULDER PAD SPRUE
9947010132255



RAVENWING SHOULDER PAD SPRUE
9947010132263



LEGION OF THE DAMNED SHOULDER PAD SPRUE 1
9947010132261



LEGION OF THE DAMNED SHOULDER PAD SPRUE 2
9947010132262



IMPERIAL FISTS SHOULDER PAD SPRUE
9947010132260



LONG FANGS SHOULDER PAD SPRUE 1
9947010132268



LONG FANGS SHOULDER PAD SPRUE 2
9947010132269



BLOOD CLAWS SHOULDER PAD SPRUE 1
9947010132264



BLOOD CLAWS SHOULDER PAD SPRUE 2
9947010132265



GREY HUNTERS SHOULDER PAD SPRUE 1
9947010132266



GREY HUNTERS SHOULDER PAD SPRUE 2
9947010132267



SPACE WOLF WOLFGUARD SHOULDER PAD SPRUE
9947010132271



RAGNAR'S COMPANY SHOULDER PAD SPRUE
9947010132270



ULTRAMARINES SHOULDER PAD SPRUE
9947010132276



ULTRAMARINES VETERAN SHOULDER PAD SPRUE
9947010132277



WHITE SCARS SHOULDER PAD SPRUE
9947010132280

TACTICS



TIPS FOR WINNING WITH SPACE MARINES

- A. A Chaplain with a jump pack can lead an Assault Squad into battle and make the unit *Fearless* in addition to giving it the ability to reroll misses on the charge. Another version of this very powerful unit would involve the Chaplain leading a Veteran Squad with lightning claws, a power weapon, and a Veteran Sergeant with a power fist. The Veteran Squad could take the *Furious Charge* skill for even more close combat ability.
- B. Scout Bikers can achieve a charge on the 1st turn with the Scouts pregame move. Another good use for Scout Bikers or a Bike Squadron is to give a teleport homer to the Veteran Sergeant. The bikers can move quite far with the *Turbo Boost* rule or the pregame move. Thus, the Veteran Sergeant can guide in a Terminator Squad nearly anywhere you want.
- C. Against certain armies a Librarian with *Fear of the Darkness* can be devastating. The ability to make multiple units take a Morale Test at -2 to their Leadership means that even other Space Marines could be sent running. Giving the Librarian a jump pack or a bike to keep up with units as they fall back. As long as the Librarian (or any other enemy unit) is within 6", falling back units cannot regroup. Cunning deployment of Whirlwind Castellan missiles can also help get more bang for your buck as well!
- D. Alternatives to Devastator Squads, if you have used all your Heavy Support choices on things like Vindicators and Whirlwinds, are Techmarines and Gun Servitors. A squad of four Gun Servitors armed with Heavy Bolters can unleash 12 Strength 4 shots, enough to put a dent even in a well-armed unit. For more shooting capability, arm the Techmarine a Storm Bolter and give the unit a Razorback equipped with a Heavy Bolter.

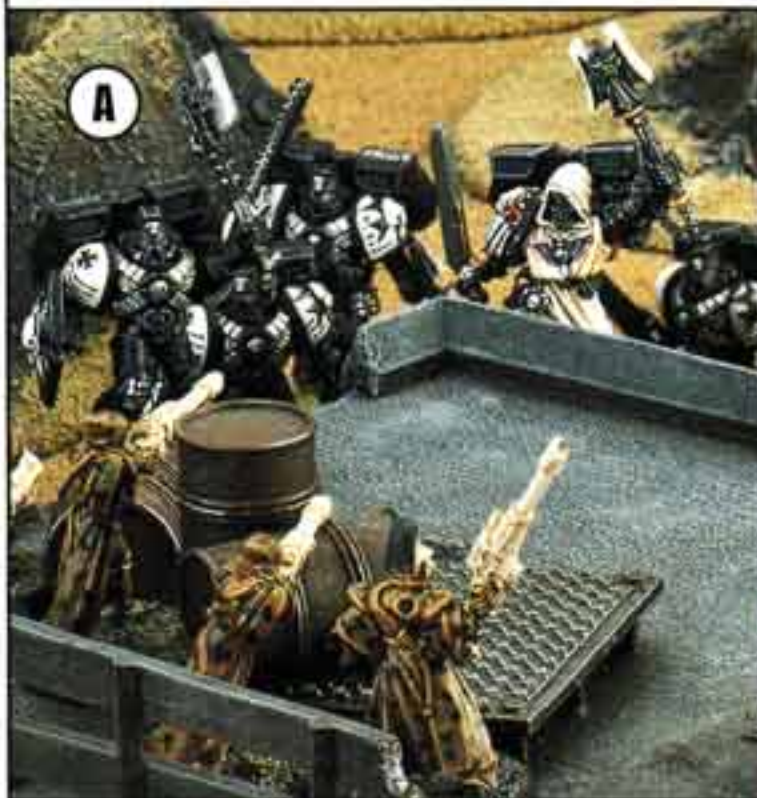

COUNTERTACTICS

TIPS FOR FIGHTING AGAINST SPACE MARINES

- A. Toolled-up squads intended for assault are an excellent target for your heavy weapons. Another option is to face this squad with one of your own that is likely either to be wiped out or to run away. In either case, the Assault Squad or Veterans Squad will then be exposed to your fire.
- B. If Scout Bikers use the pregame move to approach your lines, you should quickly be within rapid fire distance. Scout Bikes are not as durable as other bikes and are great targets for autocannons and heavy bolters. If you think that the teleport homer is going to be a factor, deploy your units where the Terminators won't have much room to appear in once they *Deep Strike*.
- C. Low-Leadership armies will always have a hard time with Morale Checks, but many have ways to circumvent their low Leadership with things like Vox-casters, Tau Ethereals, and Mob Size Checks.
- D. While Gun Servitors have the Ballistic Skill of a Space Marine, their Toughness and Save leave a bit to be desired. Return fire on the Gun Servitor unit or a unit with decent close combat skill will likely eliminate the Gun Servitors. A few low-AP shots or a power weapon will help to eliminate the Techmarine. After the Servitors are gone, he is rather less fearsome.



COLORS OF WAR

KEY

■ Top Box(es): Basecoat Colors & Ink Washes ■ Bottom Box(es): Highlights ■ Mixed Colors

HOW TO PAINT SPACE MARINES

60040101004

Praise the Emperor! *How to Paint Space Marines* is THE essential reference for any Space Marine player! This book is chock full of great hobby tips as well as examples of paint schemes and heraldry to make great and unique Chapters of your own.



CHAPTERS OF THE FIRST FOUNDING

Under the Emperor's directives, 20 genetically modified super beings were created. These Primarchs, as they came to be known, passed their genetic imprint to make the first 20 Chapters of Space Marines. These original 20 Chapters are still referred to as the First Founding Chapters.



BLOOD ANGELS
Chaos Black, Red Gore
Shadow Grey, Blood Red



DARK ANGELS
Chaos Black, Dark Angels Green
Goblin Green, Scorpion Green



IMPERIAL FISTS
Fiery Orange, Golden Yellow
Blood Red, Bad Moon Yellow



IRON HANDS
Chaos Black, Ultramarines Blue
Shadow Grey, Burnished Gold



RAVEN GUARD
Chaos Black, Boltgun Metal
Shadow Grey, Mithril Silver



SALAMANDERS
Chaos Black, Snot Green
Sunburst Yellow, Scorpion Green



SPACE WOLVES
Space Wolves Grey, Golden Yellow
Skull White, Sunburst Yellow



ULTRAMARINES
Regal Blue, Blood Red
Ultramarines Blue, Golden Yellow



WHITE SCARS
Shadow Grey, Blood Red
Skull White, Bad Moon Yellow

KNOWN SUCCESSOR CHAPTERS

After the Primarch Horus corrupted half of the Space Marine Legions and led a great rebellion against the Emperor, it was decided to make smaller and more flexible formations. Many of the loyal First Founding Chapters remained but were broken down into further "Successor Chapters."



ANGELS ENCARMINE
Chaos Black, Blood Red
Shadow Grey, Golden Yellow



ANGELS OF ABSOLUTION
Bronzed Flesh, Dark Angels Green
Bleached Bone, Scorpion Green



ANGELS OF VENGEANCE
Chaos Black, Red Gore
Shadow Grey, Blood Red

All miniatures are supplied unpainted. Models, bits, and sprues are all shown actual size unless otherwise noted. Contents may vary slightly from those shown.

KEY

■ Top Box(es): Basecoat Colors & Ink Washes ■ Bottom Box(es): Highlights ■ Mixed Colors

COLORS OF WAR



ANGELS SANGUINE
Regal Blue, Red Gore
Bleached Bone, Blood Red



ANGELS VERMILLION
Chaos Black & Scab Red, Golden Yellow
Blood Red, Sunburst Yellow



AURORA
Chaos Black, Goblin Green
Skull White, Scorpion Green



BLACK TEMPLARS
Chaos Black, Fortress Grey
Fortress Grey, Skull White



CRIMSON FISTS
Midnight Blue, Red Gore
Enchanted Blue, Blood Red



DOOM EAGLES
Boltgun Metal, Chaos Black
Mithril Silver, Blood Red



FLESH EATERS
Chaos Black, Blood Red
Shadow Grey, Skull White



FLESH TEARERS
Chaos Black, Scab Red
Shadow Grey, Blood Red



MARAUDERS
Fiery Orange, Sunburst Yellow
Skull White, Blood Red



NOVAMARINES
Regal Blue, Bleached Bone
Ultramarines Blue, Skull White



RAMPAGERS
Scab Red, Sunburst Yellow
Blood Red, Skull White



RAPTORS
Scorched Brown & Camo Green
Rotting Flesh, Skull White



RED TALONS
Chaos Black, Blood Red
Skull White, Golden Yellow



REVILERS
Chaos Black, Shadow Grey
Fortress Grey, Sunburst Yellow



SILVER SKULLS
Chaos Black, Chainmail
Enchanted Blue, Shining Gold



SONS OF GULLIMAN
Codex Grey, Regal Blue
Skull White, Ultramarines Blue



SHOWCASE

Below: Brett DeWald's Void Reaper Scouts won second place in the Warhammer 40,000 Squad category at the 2004 Baltimore Games Day Golden Demon painting competition.



Right: Brett DeWald's Void Reaper Librarian won second place in the Warhammer 40,000 Single Miniature category at the 2004 Baltimore Games Day Golden Demon painting competition.



Right: Bannus, Iron Hands Venerable Dreadnought won Joe Orteza first place in the Warhammer 40,000 Vehicle category at the 2004 Atlanta Games Day Golden Demon painting competition.



All miniatures are supplied unpainted. Models, bits, and sprues are all shown actual size unless otherwise noted. Contents may vary slightly from those shown.

SHOWCASE



Above: Doug Braun's Yellow Jackets were a runner-up at the 2004 Chicago Golden Demon painting competition.



Above: Chris Borer's Praetor Dreadnought won third place in the Open Competition at the 2004 Canadian Golden Demon.

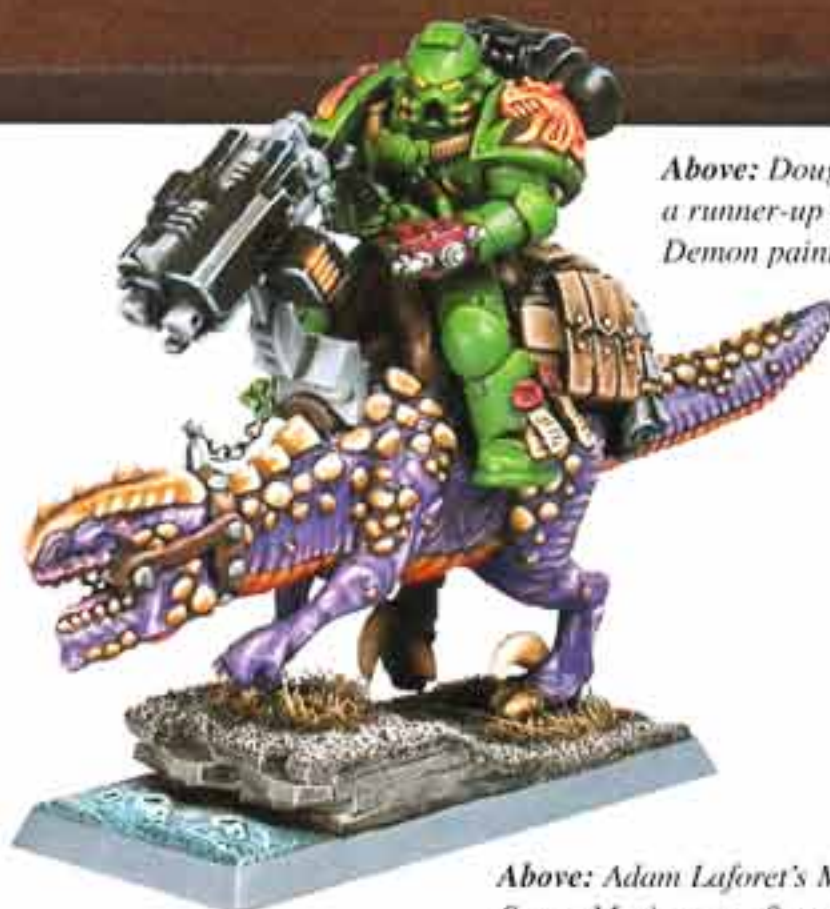

Above: Adam Laforet's Mounted Space Marine won first place in the Open Competition at the 2004 Canadian Golden Demon painting competition.

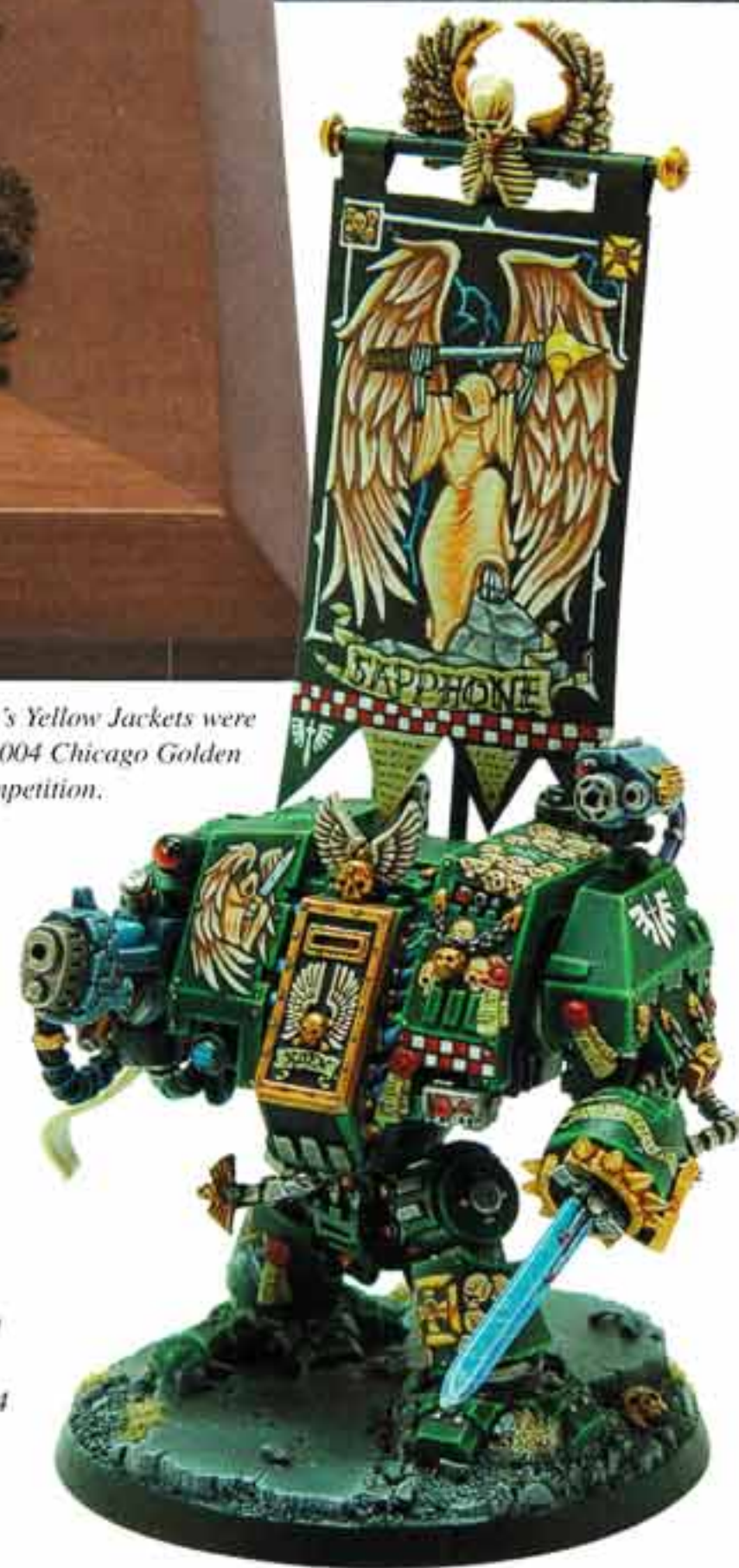

Above: Koen Baker's Dark Angel Dreadnought won third place in the Warhammer 40,000 Vehicle category at the 2003 UK Games Day Golden Demon painting competition.



Left: This Iron Hands Veteran Squad by Nathan Comanse won second place in the Warhammer 40,000 Squad category at the 2004 Chicago Games Day Golden Demon painting competition.



SHOWCASE



Above: Ryan Campbell's Ultramarine Assault Squad won second place in the Warhammer 40,000 Squad category at the 2004 LA Games Day Golden Demon painting competition.

Below: Jason Swisher's Pre-Heresy Dreadnought won second place at the 2004 Baltimore Golden Demon painting competition.



Right: L.G. Pradal's Sanguinius was a runner-up at the 2004 French Golden Demon painting competition.

Below: Nathan Comanse's Space Wolf Fong Fang was a runner-up at the 2004 Chicago Games Day Golden Demon painting competition.



Left: Jeff Freeman's Furioso Dreadnought won third place in the Warhammer 40,000 Vehicle category at the 2004 Atlanta Games Day Golden Demon painting competition.



ALTERNATE MODEL – TROOPS

Grey Slayers

COMPONENTS FOR 10 COMPLETE MODELS

- 99380101012 Space Wolf Accessory Sprue
- 99380101022 Space Marine Assault Sprue
- 99380101023 Space Marine Tactical Sprue
- 99380201010 Chaos Marauder Sprue A
- 99380201011 Chaos Marauder Sprue B
- 99390102003 Chaos Space Marine Packs

COMPLEXITY RATING



All illustrations are supplied unpainted. Models, bits, and sprues are all shown actual size unless otherwise noted. Contents may vary slightly from those shown.

Below: Chris Borer's Praetor Marine Command Squad won second place in the Warhammer 40,000 Squad category at the 2004 Canadian Games Day Golden Demon painting competition.

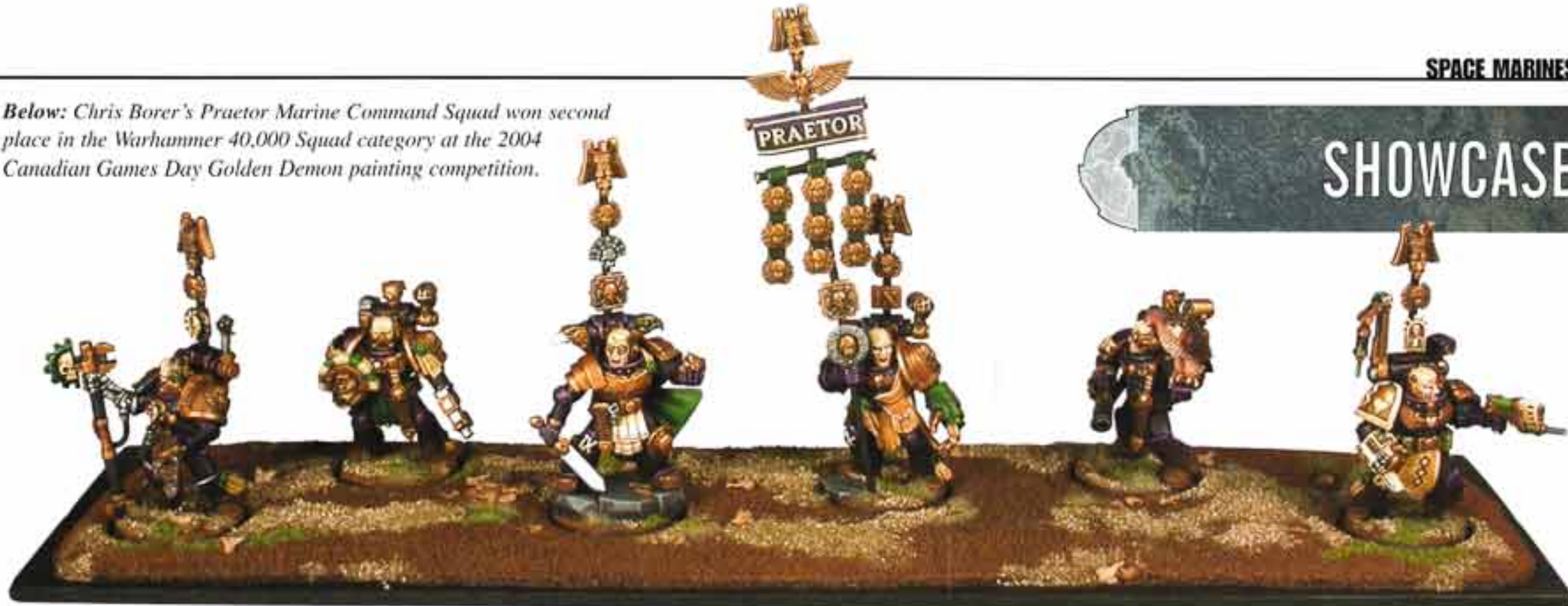

SHOWCASE

Below: Troy Clifton won second place in the Warhammer 40,000 Battle Scene category with "Snowblind" at the 2004 Atlanta Games Day Golden Demon painting competition.

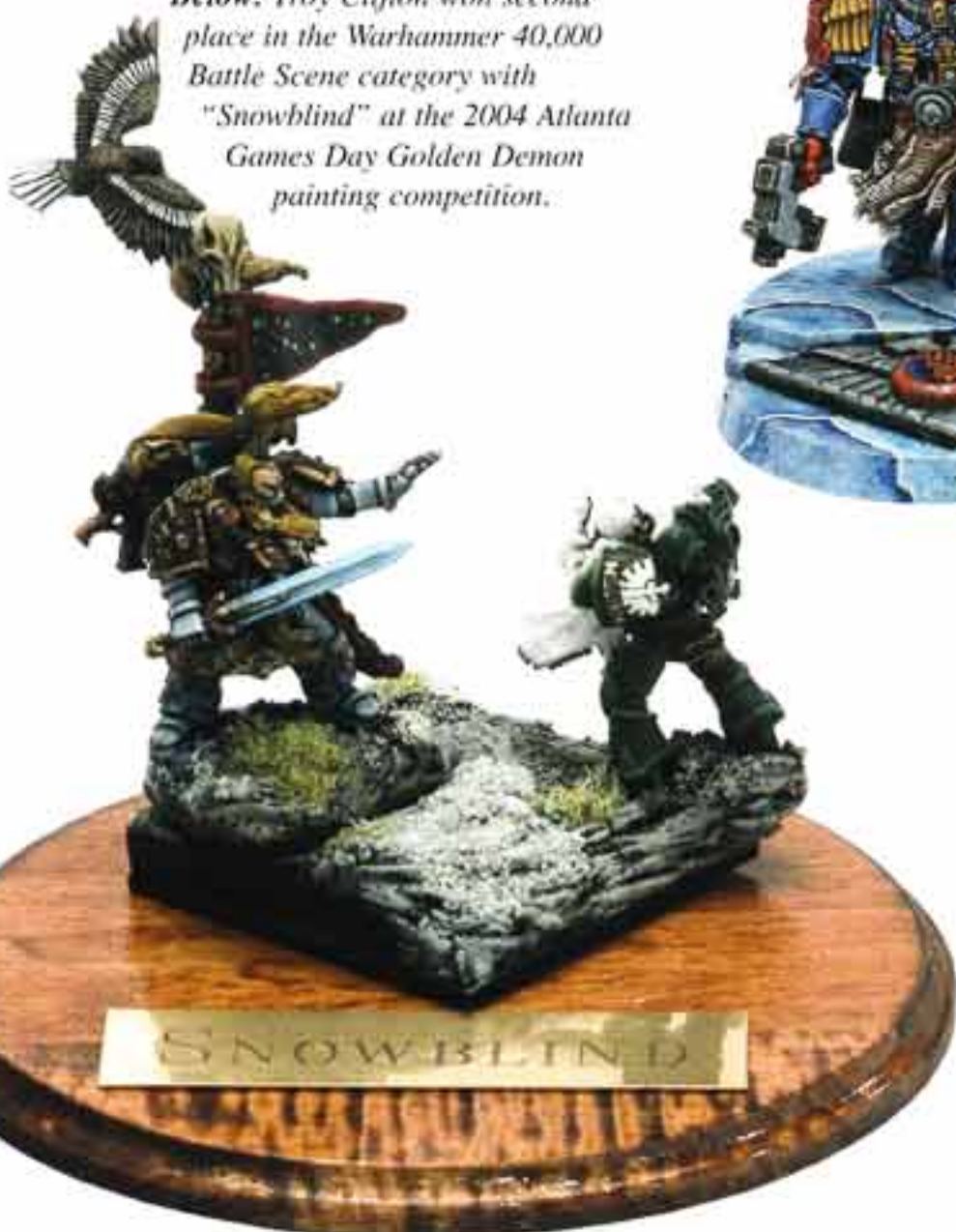

Left: Brice Coganour's Crimson Fist Sergeant was a runner-up at the 2004 LA Golden Demon painting competition.



Below: This Space Wolf Lord by Greg Smalling was a runner-up at the 2004 Baltimore Golden Demon painting competition.



Above: Bryan Shaw's Deathwing Dreadnought was a runner-up at the 2004 LA Games Day Golden Demon painting competition.

ALTERNATE MODEL – ELITES
Tyranid Hunters

COMPONENTS FOR 5 COMPLETE MODELS

- 99380101023 Space Marine Tactical Sprue
- 99380106001 Tyranid Hormagaunt Sprue
- 99380106005 Tyranid Warrior Sprue
- 9947010121906 Scout Biker Bolter
- 9947010130028 Veteran Lightning Claws

COMPLEXITY RATING



All miniature are supplied unpainted. Models, kits, and sprues are all shown actual size unless noted. Contents may vary slightly from those shown.



TAU

Shas'ō Vior'la Kais, Fire Warrior Commander, watched as the Gue'la began the long trek up the hillside. Their crude, armored vehicles lumbered forward on clanking metal tracks, dismounted warriors advancing before the machines. Kais felt sorry that he had to do this – the Gue'la could not know the folly of this attack. The Tau had claimed this world as their own. Its use had been decided, and its first colonists were already allocated from members of the Fio caste. The settlement of this world was as indisputable as a sunrise. Kais was already in the process of removing the Gue'la outpost from the planet. The Ethereals had decreed that the planet be cleared, but with typical Gue'la stubbornness, they had refused to bow before the inevitable.

The Tau inhabit an area of space near the eastern fringe of the galaxy. They are a young, dynamic race with highly advanced weaponry and technology. Though less than 2,000 years old, their fledgling empire is rapidly expanding into space and beginning to encounter the elder races of the galaxy. In galactic terms, their empire is small, based around a densely packed globular cluster of stars, which enables the Tau to travel between them without many of the dangers normally associated with warp travel. The Tau empire also encompasses several alien races who have been subsumed into the empire voluntarily or whose services are bought through trade agreements.

Tau civilization is based around a rigid system of castes, each relating to the four elements of nature – fire, water, air, and earth. These castes dictate each Tau's role within society: warrior, bureaucrat, pilot, or worker. Their rulers form a mysterious fifth caste, called the Ethereals, who bind the other castes together. The Tau empire is underpinned by the concept that it is only right and noble for the individual to set aside his own desires to work for the greater good of the empire. Overall, the Tau are very good at actualizing this ideal.



Michael Anderson's Kroot Shaper won third place at the 2003 U.K. Games Day Golden Demon painting competition.

Jason Thompson's Crisis Battlesuit Pilot was a runner up at the 2004 Chicago Games Day Golden Demon painting competition.

Collecting a Tau Army

The Tau are a very stylish and powerful army with many specialized troops at their disposal. Their main strength lies in the different types of battlesuit-equipped warriors. These warriors are hardened veterans, and their battlesuits are capable of mounting a fearsome array of firepower. In addition, their battlesuits include thick armor, which makes it very difficult for most basic troopers to take down a battlesuit-equipped Tau. If you're looking for an army that can pack a heavy punch while being able to soak up the enemy's return fire, then the Tau are the force for you. Tau technology is highly advanced and includes many exciting devices and upgrades that can be added to the battlesuits to enhance their ability to deal death and receive punishment.

Tau Fire Warriors are courageous fighters with solid leaders. If a member of the Ethereal caste accompanies them, their confidence and self-belief will keep them fighting in the face of insurmountable odds. The Tau dislike close combat and prefer to destroy their enemies at long range with high-tech weaponry, because the Tau are neither strong nor tough. When the fighting gets close and bloody, the Tau call upon their Kroot allies. The Kroot are ferocious carnivores who are capable of holding their own against most opponents.

A fully painted Tau army looks very striking on the tabletop and suits painters who want the best of both worlds. On the one hand, you

have the clean, elegant lines and bright colors of the Tau Fire warriors in their battlesuits and grav-tanks, while on the other you have the Kroot, with their barbaric, feral feel and large areas of flesh to paint. Even very basic painting techniques will quickly produce a battle-ready force and give you the chance to build a playable army quickly and easily. With your army, you can expand the frontiers of the glorious Tau empire. May the Ethereals guide you.

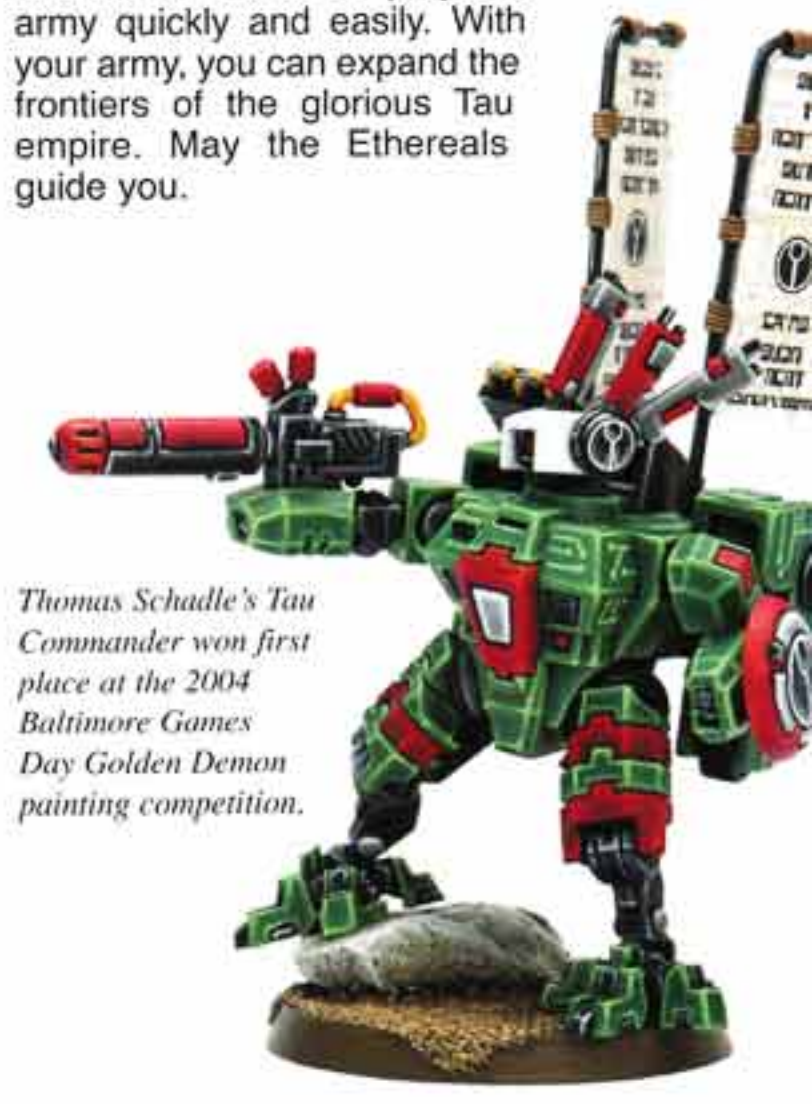

Thomas Schadle's Tau Commander won first place at the 2004 Baltimore Games Day Golden Demon painting competition.

All miniatures are supplied unpainted. Models, lists, and quotes are all shown actual size unless otherwise noted. Contents may vary slightly from those shown.



Tau Battleforce Box – 99120113002

- 12 Tau Fire Warriors
- 12 Kroot Warriors
- 3 XV8 Crisis Battlesuits
- 10 Gun Drones
- 4 Warhammer 40,000 Jungle Trees



GETTING STARTED



This 64-page rulebook contains painting and modeling guides, background, and the full rules for fielding a force of the Tau and their savage Kroot allies.

**Codex:
Tau**
60030113001



Commander O'shovah Box (1)
99140113006



AUN'SHI BODY
9947011300701



Aun'shi Blister (1)
99060113007



AUN'SHI BLADE
9947011300702



Ethereal Caste Member Blister (1)
99060113003
BIT NAME: ETHEREAL 2
BIT CODE: 9947011300302

HQ

You can also take an XV8 Crisis Battlesuit (99120113005) shown on the opposite page as a bodyguard for your Commander.



O'SHOVAH ARM
9947011300601



O'SHOVAH SHIELD
9947011300602



O'SHOVAH ANTENNA
9947011300603

Commander O'shovah comes with the Crisis Battlesuit Sprue (99390113002) and the Tau Decal Sheet (99510113001) shown on the opposite page.



Tau Gun Drone

You can take a gun or shield drone with any of your leaders. Just add the Shield Drone Antenna and Bits to the Gun Drone Sprue to create the Shield Drone.



GUN DRONE SPRUE
99390113001



Tau Shield Drone



SHIELD DRONE ANTENNA
9947011300205



SHIELD DRONE BITS
9947011300204

GETTING STARTED

Tau Battleforce Box – 99120113002

- 12 Tau Fire Warriors
- 12 Kroot Warriors
- 3 XV8 Crisis Battlesuits
- 10 Gun Drones
- 4 Warhammer 40,000 Jungle Trees



This 64-page rulebook contains painting and modeling guides, background, and the full rules for fielding a force of the Tau and their savage Kroot allies.

Codex:
Tau
60030113001

HQ



Commander O'shovah Box (1)
99140113006



AUN'SHI BODY
9947011300701



Aun'shi Blister (1)
99060113007



AUN'SHI BLADE
9947011300702



Ethereal Caste Member Blister (1)
99060113003

BIT NAME: ETHEREAL 2
BIT CODE: 9947011300302

You can also take an XV8 Crisis Battlesuit (99120113005) shown on the opposite page as a bodyguard for your Commander.



O'SHOVAH ARM
9947011300601



O'SHOVAH SHIELD
9947011300602



O'SHOVAH ANTENNA
9947011300603

Commander O'shovah comes with the Crisis Battlesuit Sprue (99390113002) and the Tau Decal Sheet (99510113001) shown on the opposite page.



Tau Gun Drone

You can take a gun or shield drone with any of your leaders. Just add the Shield Drone Antenna and Bits to the Gun Drone Sprue to create the Shield Drone.

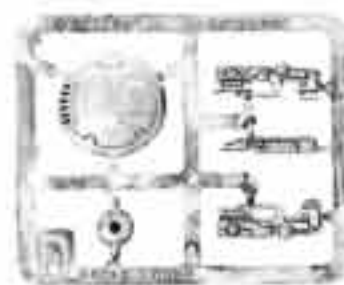

GUN DRONE SPRUE
99390113001



Tau Shield Drone



SHIELD DRONE ANTENNA
9947011300205



SHIELD DRONE BITS
9947011300204



The Gun Drone Sprue (99390113001) is shown previously.



Fire Warrior Squad Box (12 Warriors w/ 2 Gun Drones) 99120113001

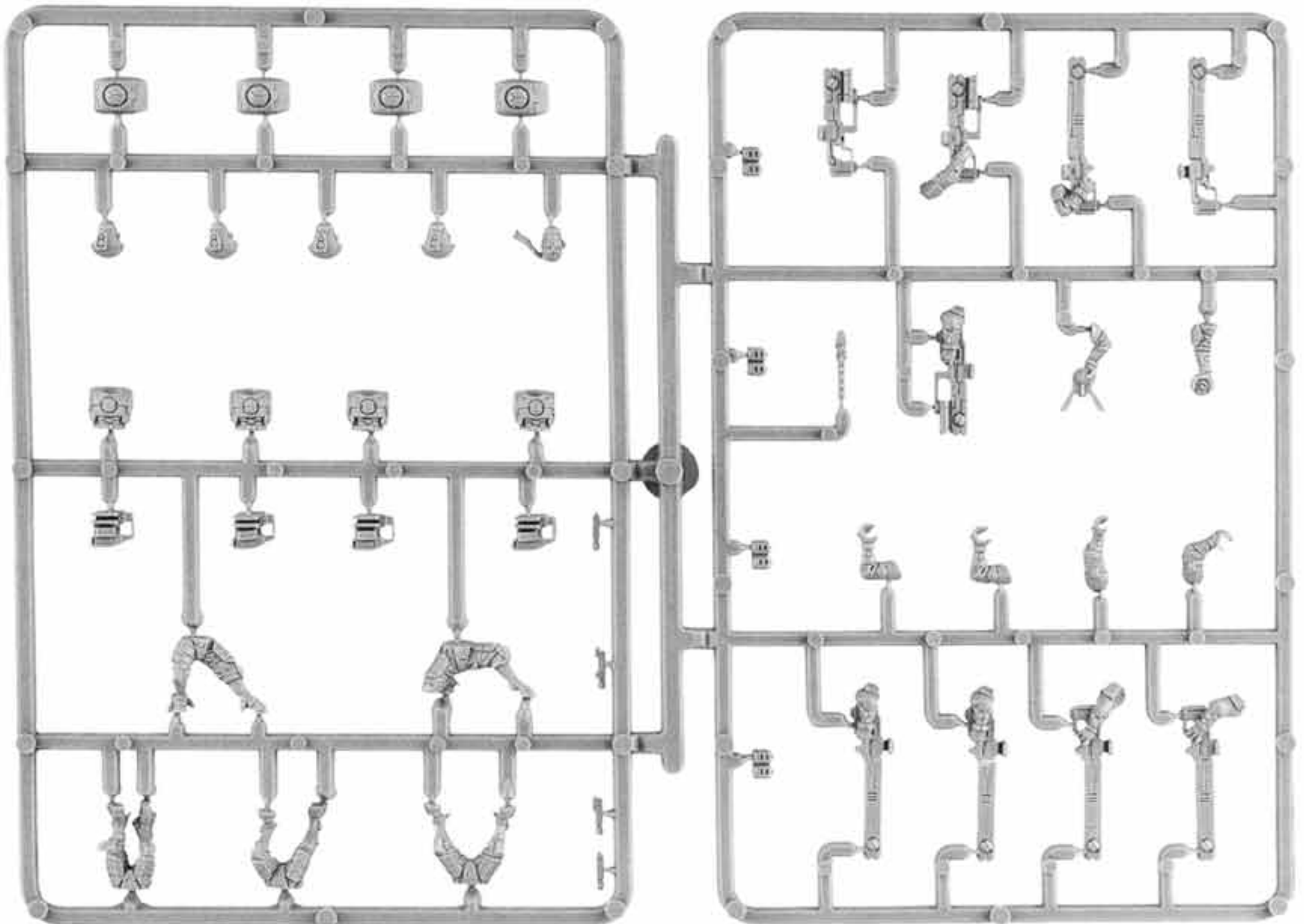

FIRE WARRIORS SPRUE (SHOWN 65% ACTUAL SIZE) 99380113001



TROOPS

PAINTING FINE DETAIL ON AUN'SHI



Paint Shining Gold on the metal jewelry and hair braids. Apply a wash of Brown Ink to these areas. When the ink dries, apply a final highlight of Mithril Silver.



Paint Brazen Brass on the armbands, coat edging, bands on the halberd, and the various glyphs. Apply a wash of Brown Ink to these areas. Finally, when the ink is dry, apply Mithril Silver highlights to these areas.

Paint the blade of the weapon with Boltgun Metal and highlight with Chainmail and then Mithril Silver. Choose some markings from *Codex: Tau* and then draw two thin pencil lines with a ruler directly on the weapon shaft. Next, draw lines the same distance apart onto a piece of paper and a mock up of the inscription. By laying out the markings beforehand, you ensure that the lettering will fit neatly on the model. Carefully paint the letters on the model. Start with the central letter and work your way out toward the ends.



FINISHING TOUCHES



Paint a basecoat of the tattoos with Chaos Black. Next, paint Blood Red over the basecoat but leave a thin outline of Chaos Black. Highlight the red areas with a lighter red.



Paint the diamond stone at the center of Aun'shi's forehead with a basecoat of Red Gore and highlight with Blood Red followed by Blazing Orange. Finally, apply a small dot of Skull White to suggest a reflection.



Paint the eyes with a basecoat of Red Gore and highlight with Blood Red.

Red Gore and highlight with Blood Red.



Kroot Shaper Blister (1)
99060114002



KROOT SHAPER BODY
9947011400201



KROOT SHAPER RIGHT ARM 1
9947011400202



KROOT SHAPER RIGHT ARM 2
9947011400203

They are fierce indeed these Kroot, and savage. I look upon them and tremble at their ferocity. I can only hope that when the enemy sees them they tremble as I do.

Por'vere Tau Cho – Water Caste Envoy to Sy'l'kell prior to the ambush of the 17th Brimlock Dragons





Kroot Carnivore squads are the most common auxiliaries serving alongside the Tau. The Kroot worlds have long been part of the empire, ever since a Tau expeditionary force helped liberate several Kroot enclaves from the Orks.

TROOPS



Kroot Carnivore Squad Box (16)
99120114001

The Kroot Carnivore squad is shown at 85% of actual size.

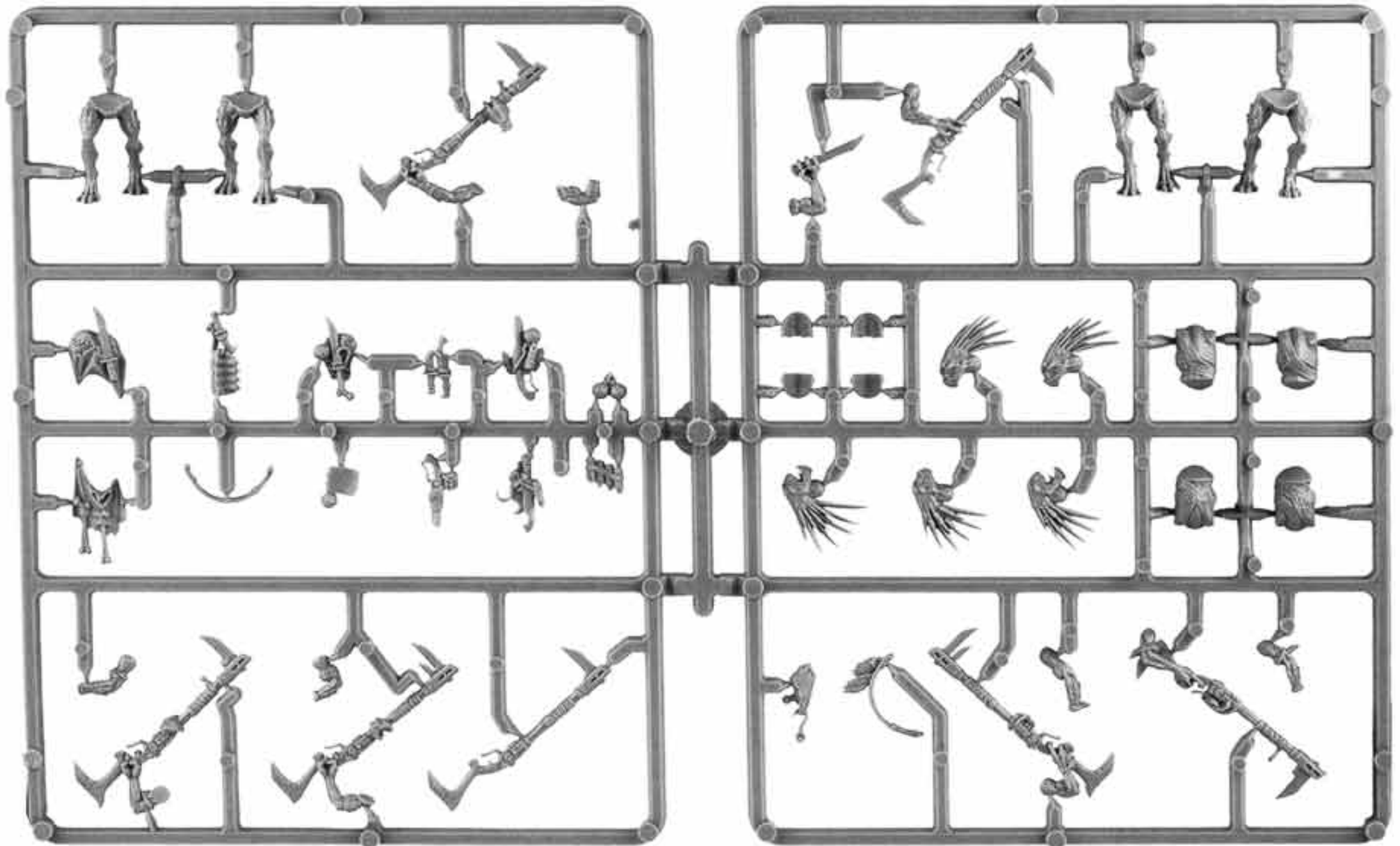

KROOT CARNIVORE SPRUE (SHOWN 65% ACTUAL SIZE)
99380114001



TROOPS



The Devilfish Troop Carrier is shown at 70% of actual size.



Devilfish Troop Carrier Box (1)
99120113003

The Tau Devilfish comes with the Tau Decal Sheet (99510113001) and two Gun Drone Sprues (99390113001) shown in the HQ section.

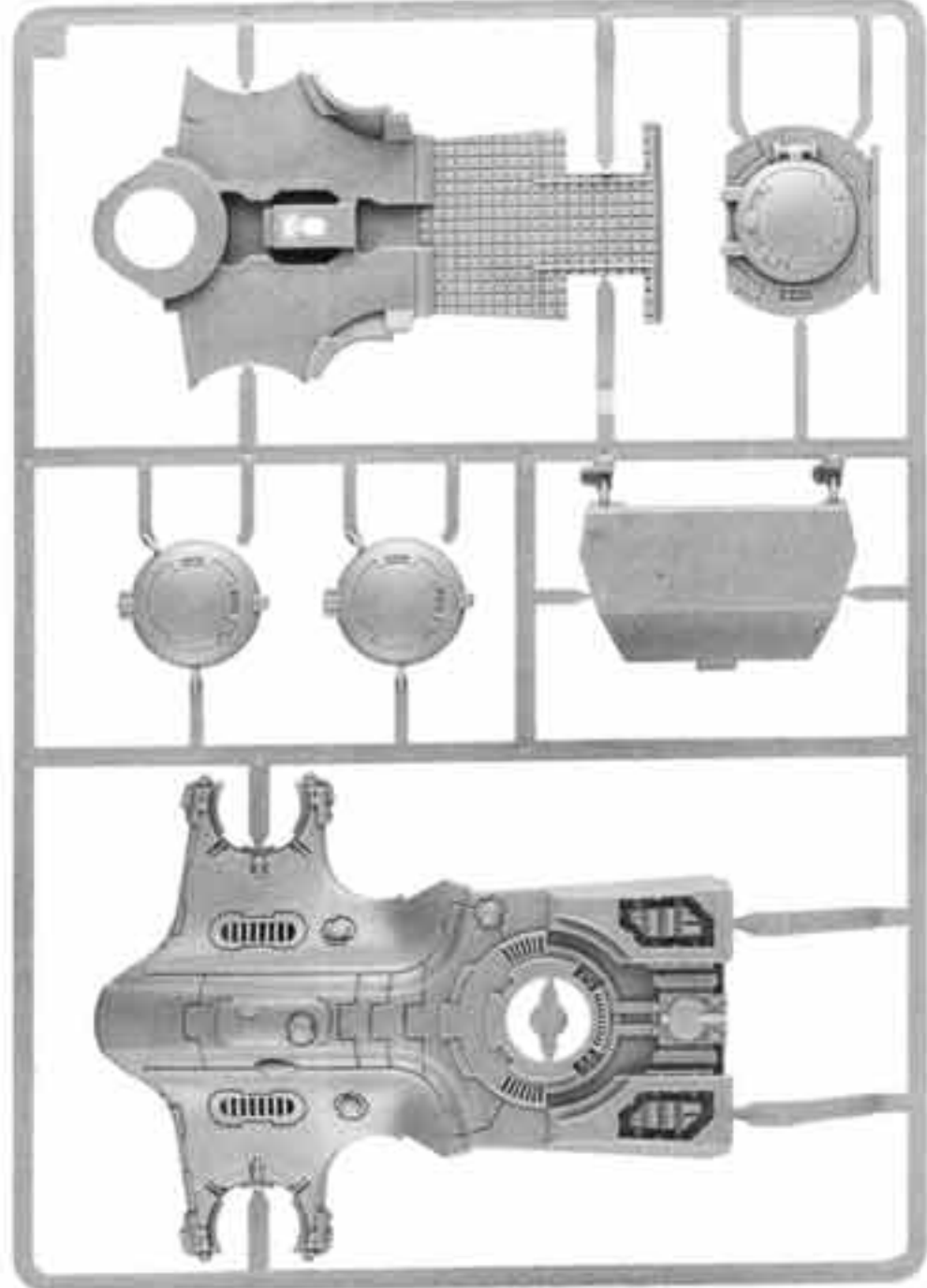

DEVILFISH SPRUE A – BODY (SHOWN 50% ACTUAL SIZE)
99390113003

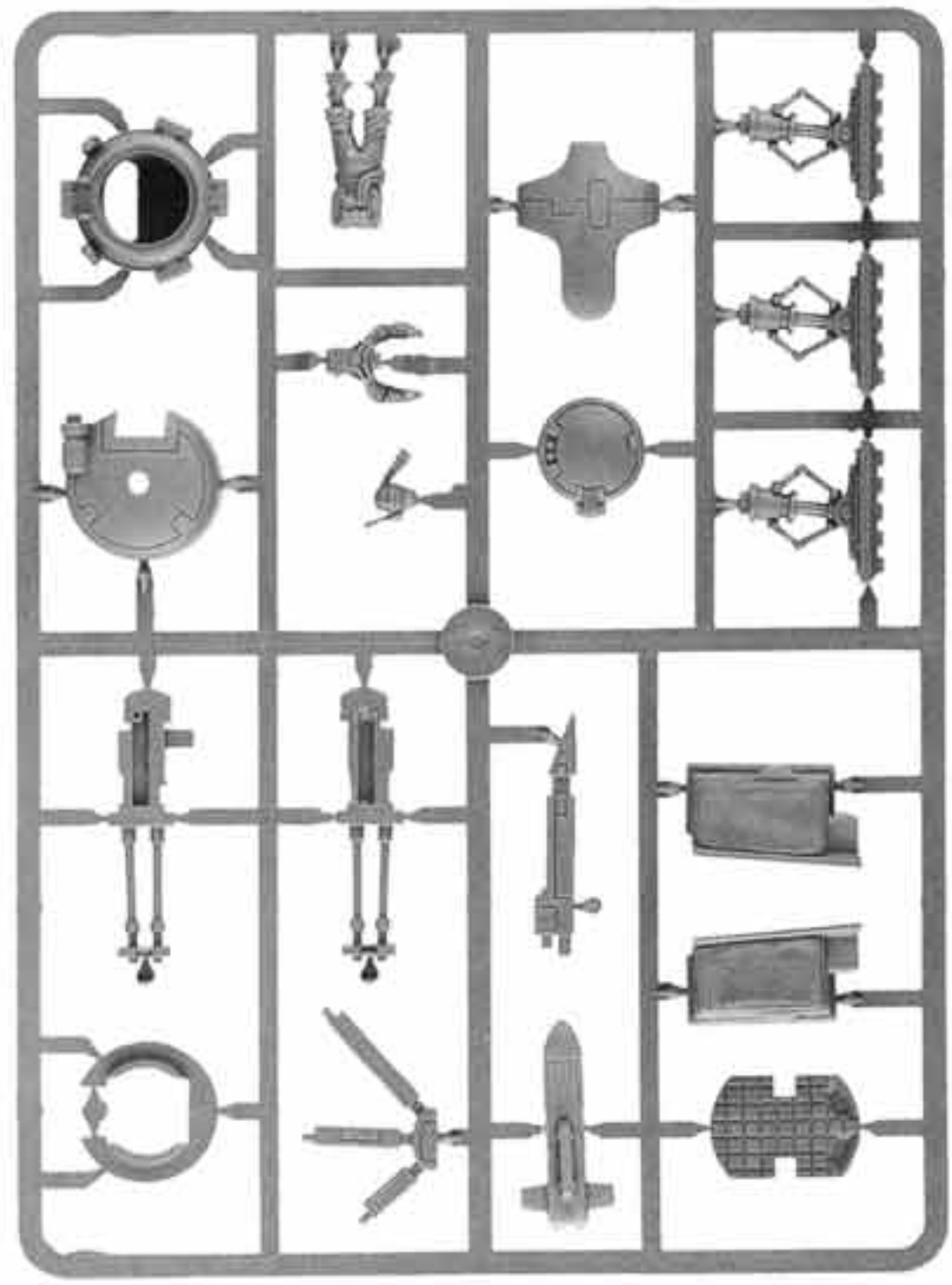

DEVILFISH SPRUE C – ACCESSORY (SHOWN AT ACTUAL SIZE)
99390113005

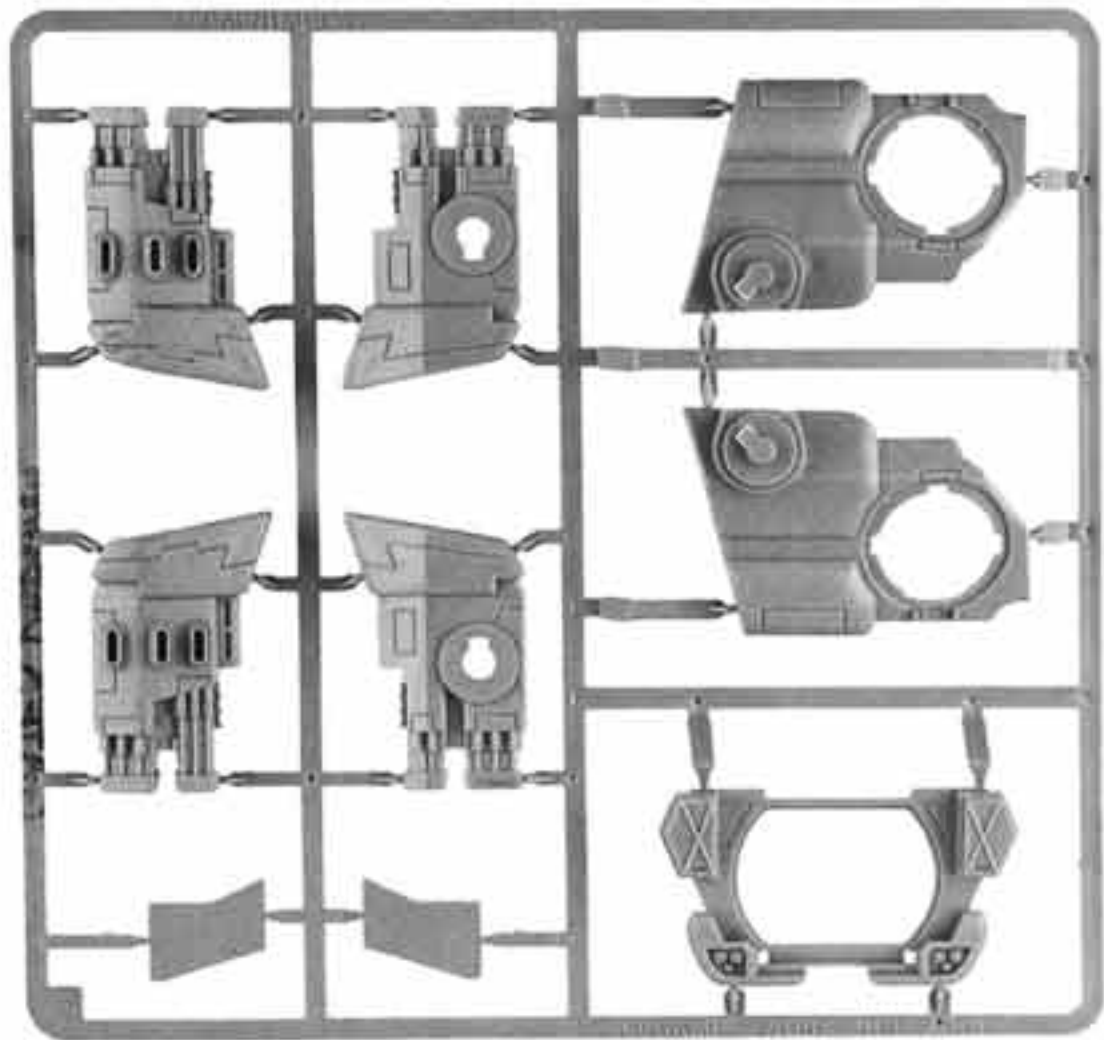

DEVILFISH SPRUE B – ENGINE (SHOWN 50% ACTUAL SIZE)
99390113004

All miniatures are supplied unpainted. Models, bits, and sprues are all shown at actual size unless otherwise noted. Contents may vary slightly from those shown.

FAST ATTACK



Tau Pathfinders Blister (3)
99060113001



Tau Pathfinders w/ Rail Rifles Blister (Random 2)
99060113014



PATHFINDER BODY 1
9947011300101



PATHFINDER BODY 2
9947011300102



PATHFINDER BODY 3
9947011300103



PATHFINDER CARBINE 1
9947011300104



PATHFINDER CARBINE 2
9947011300105



PATHFINDER BODY 4
9947011301301



PATHFINDER BODY 5
9947011301302



PATHFINDER BODY 6
9947011301303



PATHFINDER CARBINE 3
9947011300106



PATHFINDER RAIL RIFLE 1
9947011301304



PATHFINDER RAIL RIFLE 2
9947011301305



PATHFINDER RAIL RIFLE 3
9947011301306



Pathfinder Shas'ui w/ Shield Drone (2)
99060113002

The Shield Drone bits are shown in the HQ section.



PATHFINDER SHAS'UI
9947011300203

MAKING A KROOT ENCAMPMENT

Although the Kroot prefer to lurk in trees and other hiding places, there are times where this is not possible, and they must camp. To begin making your Kroot encampment, print out the templates for the tents from our web site:

http://us.games-workshop.com/games/40k/tau/terrain/tau_kroot_encampment.htm

Glue or pin the template to a sheet of thin cardboard and cut out the tent along the solid lines. Cut holes for the tabs. Next, score the dotted lines to create folds by lightly applying pressure with your modeling knife to cut halfway through the cardboard. Rescore any fold lines that won't bend easily.



Use white glue to stick your tent together. Glue the main tent structure by putting glue on the tab and folding the tent. Next, glue the

internal wall (the triangle bit) into place about a quarter of the way into the main tent structure. Finally, glue the doorway into place. Repeat the process for the rest of your tents. We strongly suggest that you base the tents on pieces of plasticard, corrugated cardboard, or foamcore so that they are more sturdy.

FINISHING OFF

First, you may want to add a little flock to the base for more detail. For the main color of the tents, spray them with Bestial Brown followed by Bubonic Brown from a distance. For the worn down, muddy areas around the tent entrances, drybrush with Bubonic Brown followed by Bleached Bone. Then drybrush the base with Goblin Green for the grass.

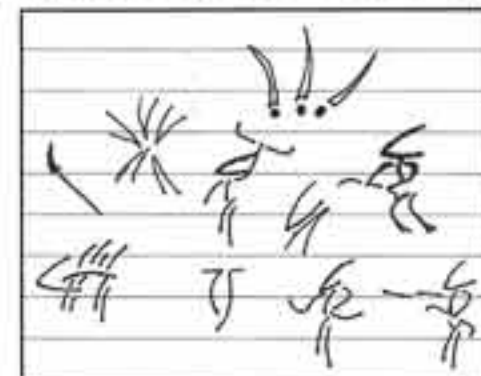

Finally, to add detail to the tents, paint some glyphs onto them. Use simple geometric patterns of Kroot Warriors.

You can draw these glyphs freehand right onto the tent panels with a black Uniball pen. Above are some sketched practice glyphs.





FAST ATTACK



Kroot Hounds Blister (Random 2)
99060114003



KROOT HOUND LEG SPRUE 1
9947011400305



KROOT HOUND LEG SPRUE 2
9947011400306



KROOT HOUND BODY 1
9947011400301



KROOT HOUND BODY 2
9947011400302



KROOT HOUND BODY 3
9947011400303



KROOT HOUND BODY 4
9947011400304

HEAVY SUPPORT



Krootox Blister (Random 1)
99060114001



KROOTOX RIDER 1
9947011400101



KROOTOX HEAD 1
9947011400103



KROOTOX RIDER 2
9947011400102



KROOTOX HEAD 2
9947011400104



KROOTOX BODY RIGHT SIDE
9947011400105



KROOTOX BODY LEFT SIDE
9947011400106



The Hammerhead comes with Devilfish Sprues A, B, and C (99390113003-5) shown in the Troops section as well as the Tau Drone Sprue (99390113001) and the Tau Decal Sheet (99510113001) shown in the HQ section.

The Hammerhead Tank is shown at 50% of actual size.

HEAVY SUPPORT



The Hammerhead Tank comes with with an ion cannon as an option to replace the rail gun.



Hammerhead Tank Box (1)
99120113004



BROADSIDE RAIL GUN
9947011300501



BROADSIDE VENT
9947011300502



BROADSIDE RIGHT ARM
9947011300503



BROADSIDE MISSILES
9947011300504



BROADSIDE LEFT ARM
9947011300505



BROADSIDE FOOT
9947011300506

The Broadside Battlesuit comes with the Tau Decal Sheet (99510113001) and the Crisis Battlesuit Sprue (99390113002) shown in the HQ section.



XV-88 Broadside Battlesuit Box (1)
99140113005

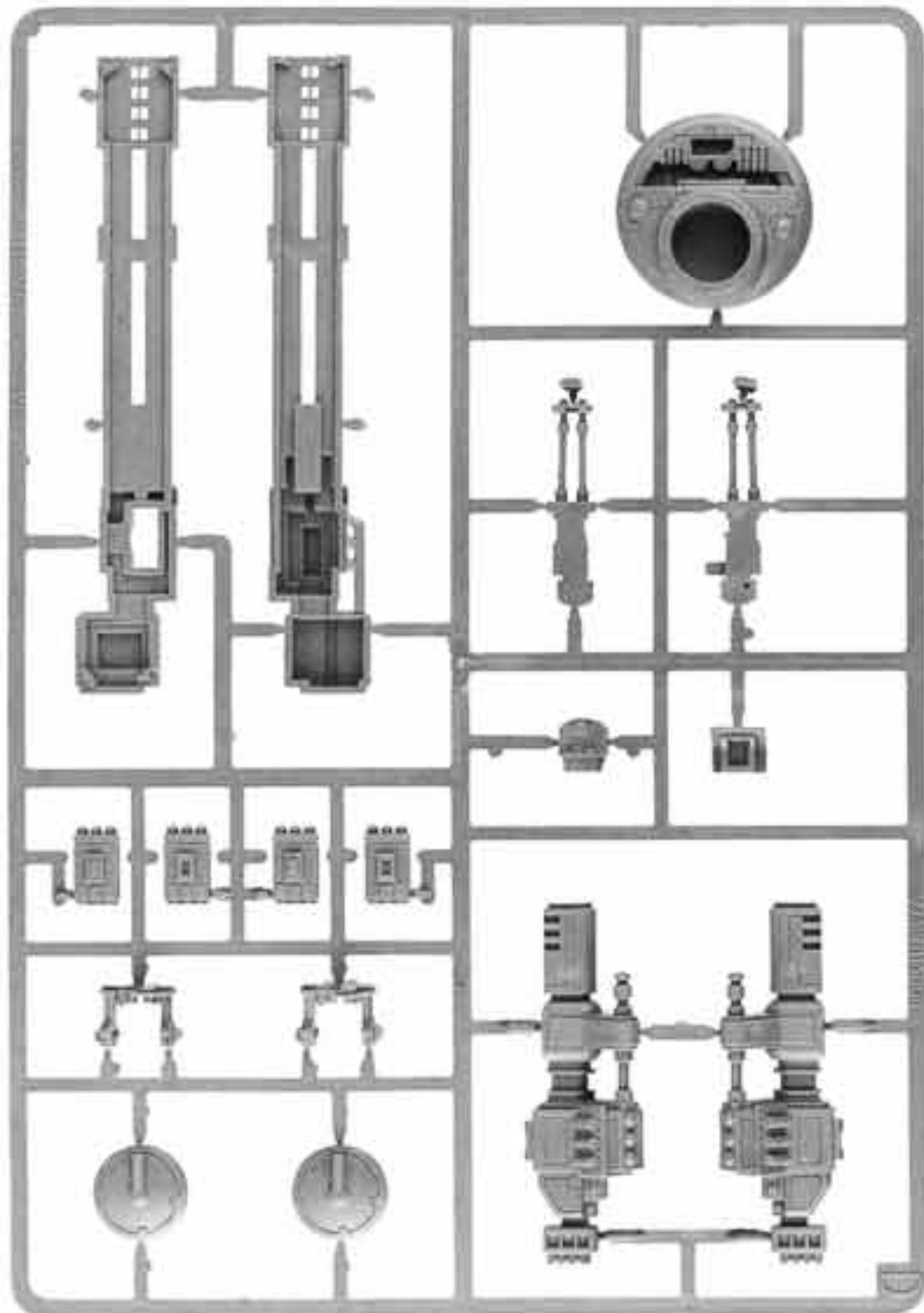

HAMMERHEAD WEAPON SPRUE (SHOWN 50% ACT. SIZE)
99390113006



COLORS OF WAR

KEY

■ Top Box(es): Basecoat Colors & Ink Washes ■ Bottom Box(es): Highlights ■ Mixed Colors



AUN'SHI
Vomit Brown, Shadow Grey
Bleached Bone, Shadow Grey & Skull White



Scorchd Brown, Vomit Brown
Snakebite Leather, Bleached Bone



Chaos Black, Codex Grey
Shadow Grey, Skull White



Dark Angels Green, Camo Green
Goblin Green, Rotting Flesh



Codex Grey, Terracotta
Fortress Grey, Tanned Flesh



XV15 STEALTH ARMOR
Chaos Black, Scab Red & Chaos Black
Fortress Grey, Scab Red & Skull White



Graveyard Earth, Hawk Turquoise
Kommando Khaki, Ice Blue



Scab Red, Regal Blue
Blood Red, Enchanted Blue



Chaos Black, Shadow Grey
Shadow Grey, Fortress Grey



Regal Blue, Vomit Brown
Ice Blue, Bleached Bone



KROOT HOUND
Codex Grey & Bestial Brown
Bubonic Brown, Bleached Bone



Red Gore, Snakebite Leather
Blood Red, Bleached Bone



Tanned Flesh & Dwarf Flesh
Dwarf Flesh, Elf Flesh



Scab Red, Scaly Green
Blood Red, Scaly Green & Bleached Bone



Blazing Orange, Scorchd Brown
Fiery Orange, Bubonic Brown



Blazing Orange, Regal Blue
Fiery Orange, Enchanted Blue



Chaos Black, Scorchd Brown
Ultramarines Blue, Bleached Bone



Golden Yellow, Yellow Ink
Golden Yellow & Skull White, Fiery Orange



Shadow Grey, Golden Yellow
Skull White, Bad Moon Yellow



Bleached Bone, Scorchd Brown
Skull White, Snakebite Leather

TACTICS

TIPS FOR WINNING WITH TAU



A. Upgrading your Fire Warrior squads to be bonded is especially good when there is also an Ethereal on the table. The bonded upgrade gives a unit under 50% of its original size the chance to rally, and an Ethereal lets a Tau player reroll all Morale Checks. Thus, a Fire Warrior squad has the option of trying to fail such a check and then fleeing from shooting losses of 25% or a lost Assault Phase. If the squad survives, it still has a chance to rally and engage the enemy once more. The bonded upgrade is even more important to small units of Crisis Suits or Stealth Suits, since these squads have small numbers to begin with and will often find themselves under 50% of their starting numbers. Occasionally, you'll want to fail the Morale Check in assault even if it does result in your unit being wiped out. As a result, the assaulters will be open for your storm of retributive firepower! All in all, an Ethereal gives you a more reliable opportunity to control the results of an assault on your lines – an excellent thing to have as a Tau Commander.

B. If the team leader of a Stealth Suit team selects the drone controller upgrade, any drones added to the unit share the stealth capabilities of a Stealth Suit for free. In addition, the weaponry on the Drones matches the range of the Stealth Suits' burst cannons – the Drones will add some additional firepower to the unit as well as the chance of pinning the enemy if they cause any casualties. A particularly effective combination involves a unit of Pathfinders using markerlights to help guide the Stealth Suits' burst cannons. Since the markerlights help the burst cannons hit on a 2+ and ignore cover saves, there's an excellent chance of wounding every model in the unit and potentially removing special weapons, heavy weapons, or even the squad's leader in one volley! Another great use for a markerlight is to guide in the submunitions round of a Hammerhead's railgun. The markerlight hit will allow the submunitions to ignore cover saves, making this tactic even better against Eldar protected by a Warlock's conceal power or Orks under the cover of a kustom force field.



COUNTERTACTICS

TIPS FOR FIGHTING AGAINST TAU

- A. Although the counter for this tactic is very basic – kill the Ethereal – it's a good idea to keep the basics in mind from time to time. Eliminating a Tau Ethereal has many benefits, among them the fact that Tau units will not be able to reroll Morale Tests. In fact, once the Ethereal is dead, most of the Tau army will have to take a Morale Check or Fall Back! When fighting the Tau, slaying the Ethereal (if there is one present) should be among your highest priorities. If you want to keep a unit of Tau from fleeing in the Assault Phase, make sure to keep at least one model in base-to-base when removing casualties if at all possible. As long as you have one model in base-to-base contact, you will get a chance to run down the unit if it flees. Another option is to turn off any power weapons or power fists in your assaulting unit to try and minimize casualties during your Assault Phase. This option might seem counterproductive at first, but consider that if you do cause enough casualties to remove all Tau in base-to-base contact, the Tau can potentially flee (and with an Ethereal, they are likely to do so) and leave your assaulting unit vulnerable in the following Shooting Phase.
- B. Although Stealth Suits can be difficult to target with weapons (especially during a mission using the *Night Fighting* special rule), ordnance and ordnance barrage weapons are a good way to knock several out of the fight. In addition, Pathfinders are not particularly difficult to kill – every markerlight you eliminate is one less to trouble you for the rest of the game. Lastly, you can always present the Stealth Suits with an armored vehicle (such as a tank) that their burst cannons can't destroy.



SHOWCASE

Below: Mike Sawada used a stylized Canadian flag paint scheme on every model in his Tau army! His efforts won him the Best Appearance award for Warhammer 40,000 at the Calgary 2002 Grand Tournament.



Below: Guido Günther won second place at the 2003 U.K. Golden Demon painting competition with his Tau Workshop.



Above: Ken Symopoulos took first place for this Tau Commander in the Warhammer 40,000 Large Model category at the 2002 Canadian Games Day Golden Demon competition.

contents may vary slightly from those shown.

SHOWCASE



ALTERNATE MODEL – HQ
Shaper Council

COMPONENTS FOR 4 COMPLETE MODELS

- 99380114001 Kroot Carnivore Sprue
- 9947010207508 Obliterator Gun Sprue (x2)
- 9947010308506 'Ard Boyz Armor Sprue (x2)
- 9947010516502 Kasrkin Backpack (x4)

COMPLEXITY RATING



ALTERNATE MODEL – FAST ATTACK
Vulture Kroot Kindred

COMPONENTS FOR 5 COMPLETE MODELS

- 99380114001 Kroot Carnivore Sprue
- 9947010207509 Obliterator Blade Sprue
- 9947010517505 Enginseer Backpack Arm
- 9947011400201 Kroot Shaper Body
- 9947991501205 Fury Left Wing (x5)
- 9947991501206 Fury Right Wing (x5)

COMPLEXITY RATING



Top: A Commander painted by Shawn Chavis.

Middle: Tim Lison won third place in the Youngbloods category at the 2004 Chicago Games Day Golden Demon competition.

Bottom: Thomas Schadle's Tau Catfish won third place at the 2004 Baltimore Games Day Golden Demon competition.

All miniatures are supplied unpainted. Models, bits, and sprues are all shown actual size unless otherwise noted. Contents may vary slightly from those shown.



TYRANIDS

++++++*Imperial Report: Mining Expedition, Galvin Sector*

++++++*Last Transmission: 000011051968*

Routine probes picked up unusual readings last week. We assumed they were meteors, as the Sentinel Defense Stations showed no signs of damage or xeno alert. A few days later, we received reports that the orbital range defense stations were off-line. Last report: malfunction/internal structural damage. The crew was unreachable. That night, everyone could see the multi-colored streaks standing out against the triple mineral moons that brought us to this region. The falling objects descended into our atmosphere and landed to the north. No word of our northern mining colonies could be reached. I alone saw the vidscreen transmission before all signals were lost. Although blurred and horrible, I recognize the multi-armed creatures. I send this last transmission to warn others. They are coming. Look to the skies.

Tyson Koch's Reaver Tyrant placed first at the 2004 LA Golden Demon painting competition.



The Tyranids are remorseless aliens that descend from the depths of space onto civilized planets and consume the indigenous populations. These alien creatures take many forms, but all share a psychic bond that allows them to act per the direction of the hive mind. This group consciousness directs all Tyranids. Indeed, without this guidance, some of the smaller species are mindless and instinctive. However, the larger and more complex creatures are known to make decisions and respond with a greater degree of intelligence. Unlike most races, the Tyranids make no use of technology or equipment. Instead, all their devices, weapons, and even starships are bio-engineered and grown from living organic material. The Tyranid swarms are always on the move through space. They relentlessly seek out new worlds to strip of their bio-mass to fuel the aliens' own insatiable conquests.

Fighting Style

Tyranid armies, thanks to their variety of troop types, bio-engineered weaponry, and biomorph upgrades, can perform a number of battlefield roles and employ various tactics. The one universal fear for opponents of a Tyranid army is being overwhelmed and ripped to pieces by razor-sharp claws.

The best Tyranid attacks involve the coordination of disparate elements. Waves of small but vicious broods of Hormagaunts race to engage the enemy in hand-to-hand combat. The Hormagaunts are supported and driven forward by more powerful creatures of the hive like Tyranid Warriors. At the same time the assault is launched, infiltrators leap out to sow confusion and panic. Flights of Gargoyles, flapping on bat-like wings, enter the fray, and larger and more monstrous creatures, like Hive Tyrants, Carnifexes, or Zoanthropes, tower over the hordes. While the foes of the Tyranids rush to counter each new threat, the distance between the two armies is closed, and the brutal feeding soon begins.

Collecting a Tyranid Army

The best place to start building a Tyranid army is to fulfill the compulsory choices from the Standard Missions Force Organization Chart. These two Troops choices and one HQ pick will form the center of your army, no matter how large or small a force you choose to construct. Tyranid players have three alternatives for their HQ choices: a single Hive Tyrant, the fearsome Broodlord, or a Brood of Tyranid Warriors. It is easier to start playing and learning how to use your force with the Tyranid Warriors choice, and you can save the awesome Hive Tyrant with all its upgrade possibilities for a time when your force grows a bit larger. Tyranid players are overloaded with great Troops choices. Termagants and Hormagaunts are always needed, and with Brood sizes ranging from 8 to 32, it's easy to start with a smallish group and gradually expand in size. As your Tyranid army expands, you can add more powerful troops. Genestealers make fantastic shock attack troops. Ravens and Gargoyles can get to the enemy in a hurry. Lictors can infiltrate the foe, and the brutal ferocity of a Carnifex is hard to pass up. For even more tactical options, many of the Broods have a Mutable genus, that is, the ability for a player to add special mutations and adaptations to the entire unit to make them faster, more deadly, or otherwise adapted to fight more effectively. Remember, somewhere in the cold depths of space, Hive Fleets are drifting closer, intent on consuming all before them.



Tyrannid Battle Force Box – 99120106008

- 3 Tyrannid Warriors
- 8 Genestealers
- 8 Hormagaunts
- 8 Termagants
- 1 Tyrannid Carnifex



GETTING STARTED

Codex: Tyrannids is your best source for all the information you need about the implacable alien horde. Inside you will find rules, background, and hobby tips to get you started on your Tyrannid army!



**Codex:
Tyrannids**
60030106002



Hive Tyrant Box (1)
99110106040



HIVE TYRANT HEAD
9947010604002



HIVE TYRANT SPRUE
9947010604011



HIVE TYRANT TAIL
9947010604010



HIVE TYRANT WHIP
9947010604003

HQ

The Hive Tyrant boxed set includes the Carnifex Sprue A (99380106010) shown in the Heavy Support section.



HIVE TYRANT TAIL BASE
9947010604008



HIVE TYRANT SWORD
9947010604001



HIVE TYRANT BODY RIGHT
9947010604004



HIVE TYRANT TORSO
9947010604005

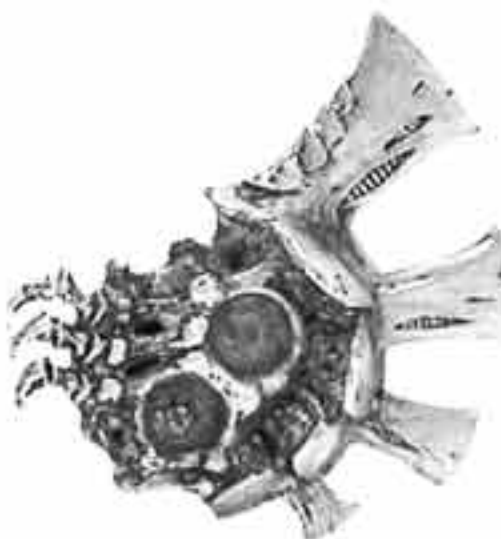

HIVE TYRANT BODY LEFT
9947010604006



HIVE TYRANT LEFT LEG
9947010604009



HIVE TYRANT RIGHT LEG
9947010604007



HQ

The Tyranid Warriors may also be used as an Elites choice.



Tyranid Warriors Box (4)
99120106003

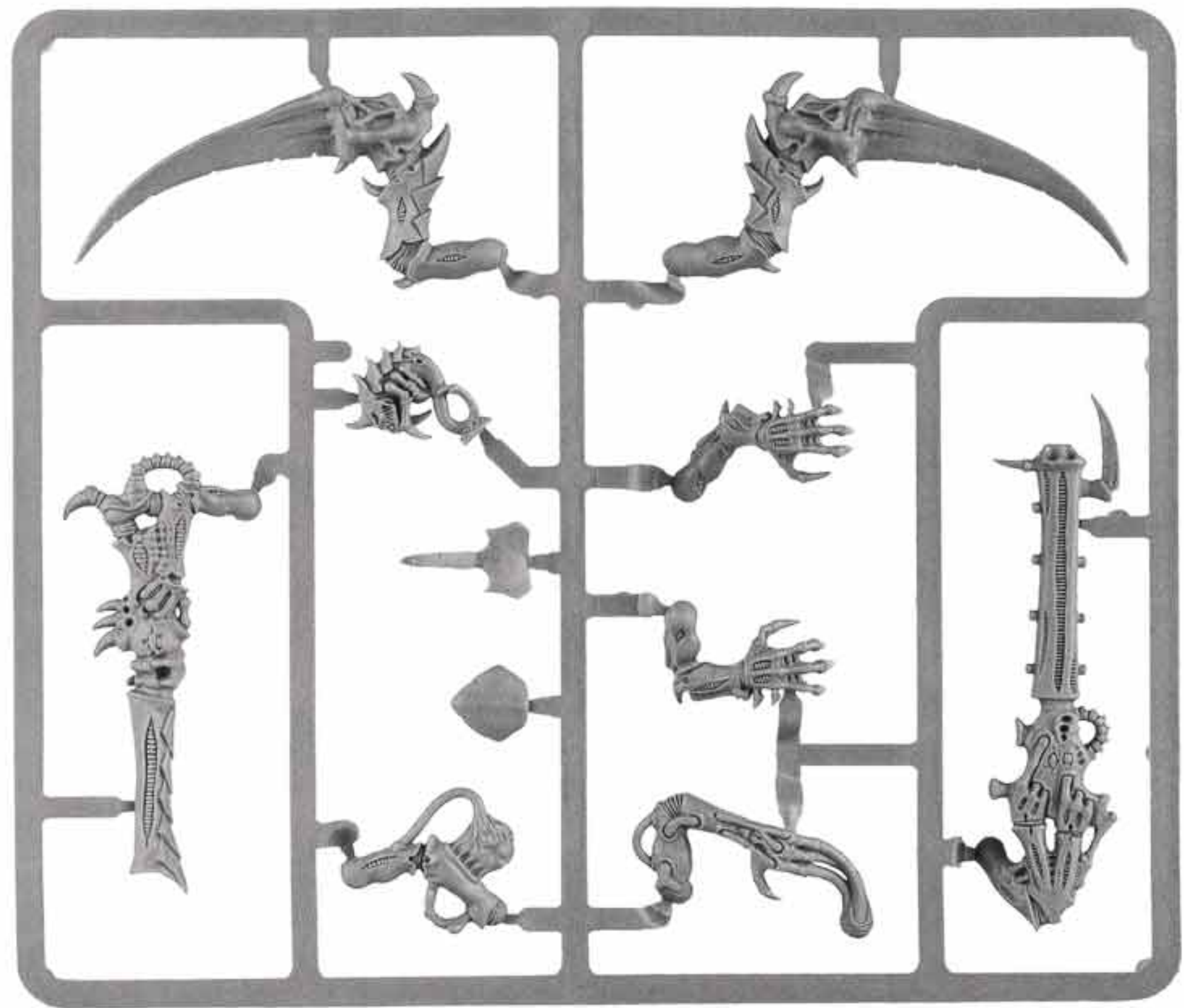

TYRANID MONSTROUS ARM SPRUE
99380106004

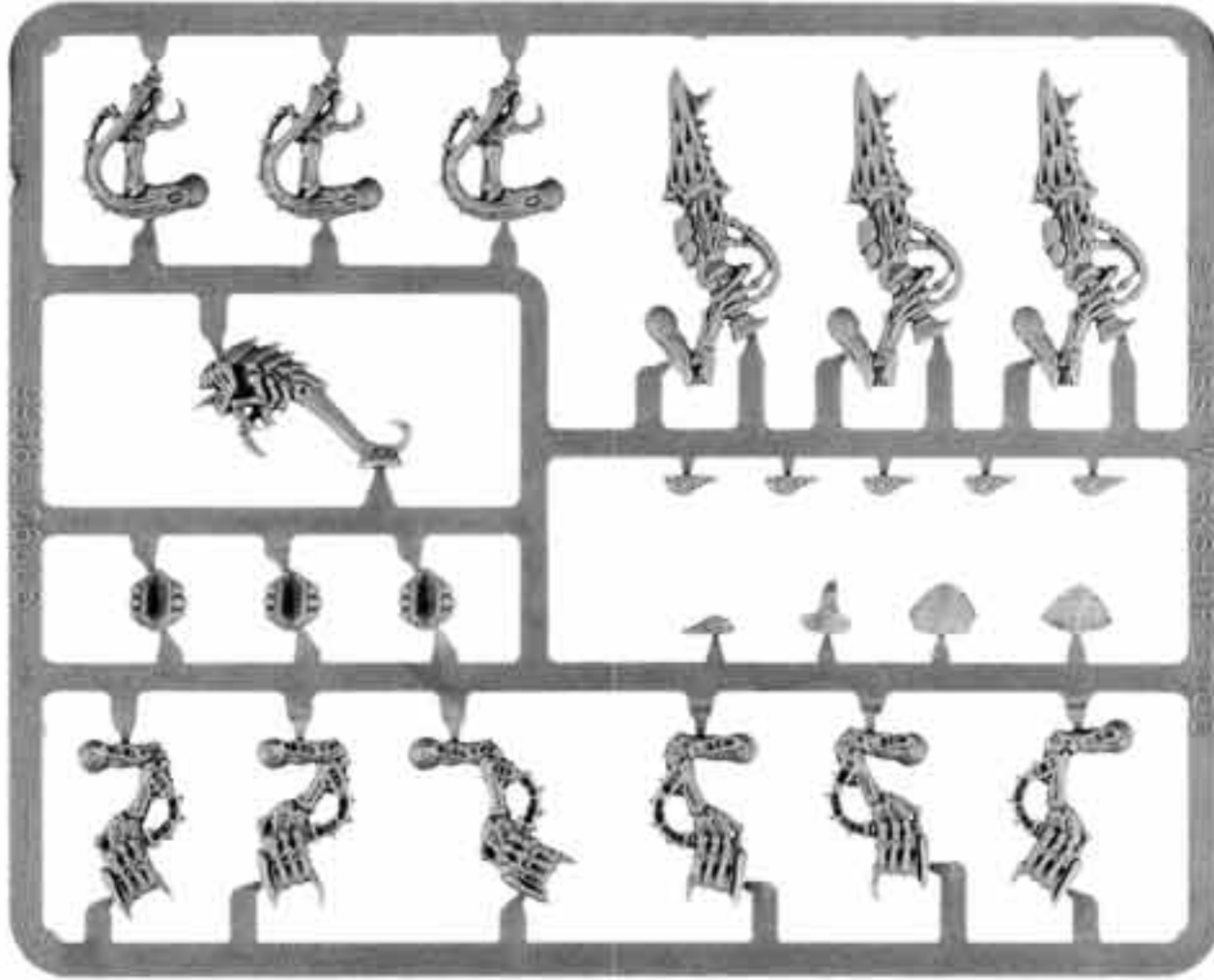

TYRANID BIOMORPH SPRUE (SHOWN 75% ACTUAL SIZE)
99380106003

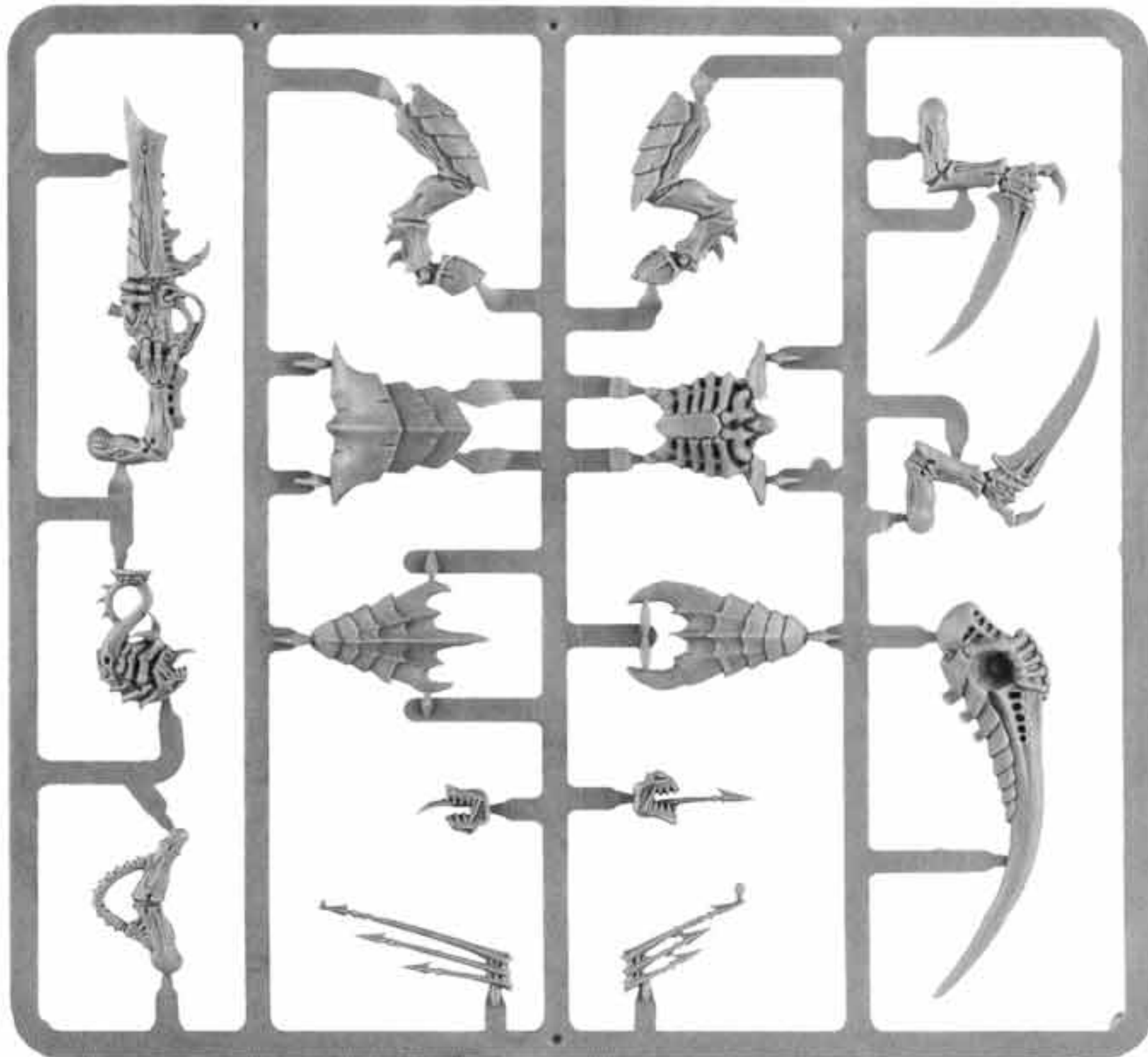

TYRANID WARRIOR SPRUE
99380106005



HQ

MAKING A TYRANID CAPILLARY TOWER

Capillary towers are huge, living structures that gather the DNA soup from the reclamation pools dotting ravaged planets.

1. Cut a 2" x 12" rectangular shape from a piece of 2" insulation foam. Make sure the ends of the rectangle are cut at an angle. Then draw two circles on both ends and curving lines on two opposite sides of your tower.



2. Following the curved lines on your rectangle, cut out the basic shape of your tower with a knife with a retractable blade or foam cutter. Round off the edges of your tower by cutting the circles on both ends and then rounding down the tower.

3. To create the "flange" at top of your tower, cut out small divots but leave a lip at the very top. Later, you will carve out a hollow on the top. To finish off rounding your tower, pick up a file or sandpaper and wear down the uneven peaks around the edges. Keep working until you get a nice even curve.



4. Now comes the tricky part! You'll need a steady hand. Carefully add a few "venting holes" to add a bit of detail to the tower's edges. You can add foam shapes to the side of your tower for additional texture. Carve out the main hole in the top of your tower with a hobby knife.

Cut a 8" circle of hardboard with a jigsaw. Glue your foam tower to this base. Add some foam rocks and dunes made from spackling, and you're ready to start painting!

For the unabridged version of this article, check out the Games Workshop web site at <http://www.games-workshop.com>.



Tyrant Guard Blister (Random 1)
99060106042



TYRANT GUARD RIGHT LEGS
9947010604206



TYRANT GUARD LEFT LEGS
9947010604205



TYRANT GUARD ARMS 2
9947010604204



TYRANT GUARD BODY 1
9947010604201



TYRANT GUARD ARMS 1
9947010604202



TYRANT GUARD BODY 2
9947010604203



Broodlord Blister (1)
99060106045



BROODLORD BODY
9947010604501



BROODLORD TALONS
9947010604503



BROODLORD ARMS
9947010604502



BROODLORD LEGS
9947010604504

ELITES



LICTOR LEFT LEG
9947010604406



LICTOR RIGHT LEG
9947010604407



LICTOR ARMS
9947010604404



LICTOR HEAD
9947010604402



LICTOR RIGHT CLAW
9947010604409



LICTOR LEFT CLAW
9947010604408



LICTOR BODY
9947010604401



Tyranid Lictor Blister (1)
99060106044

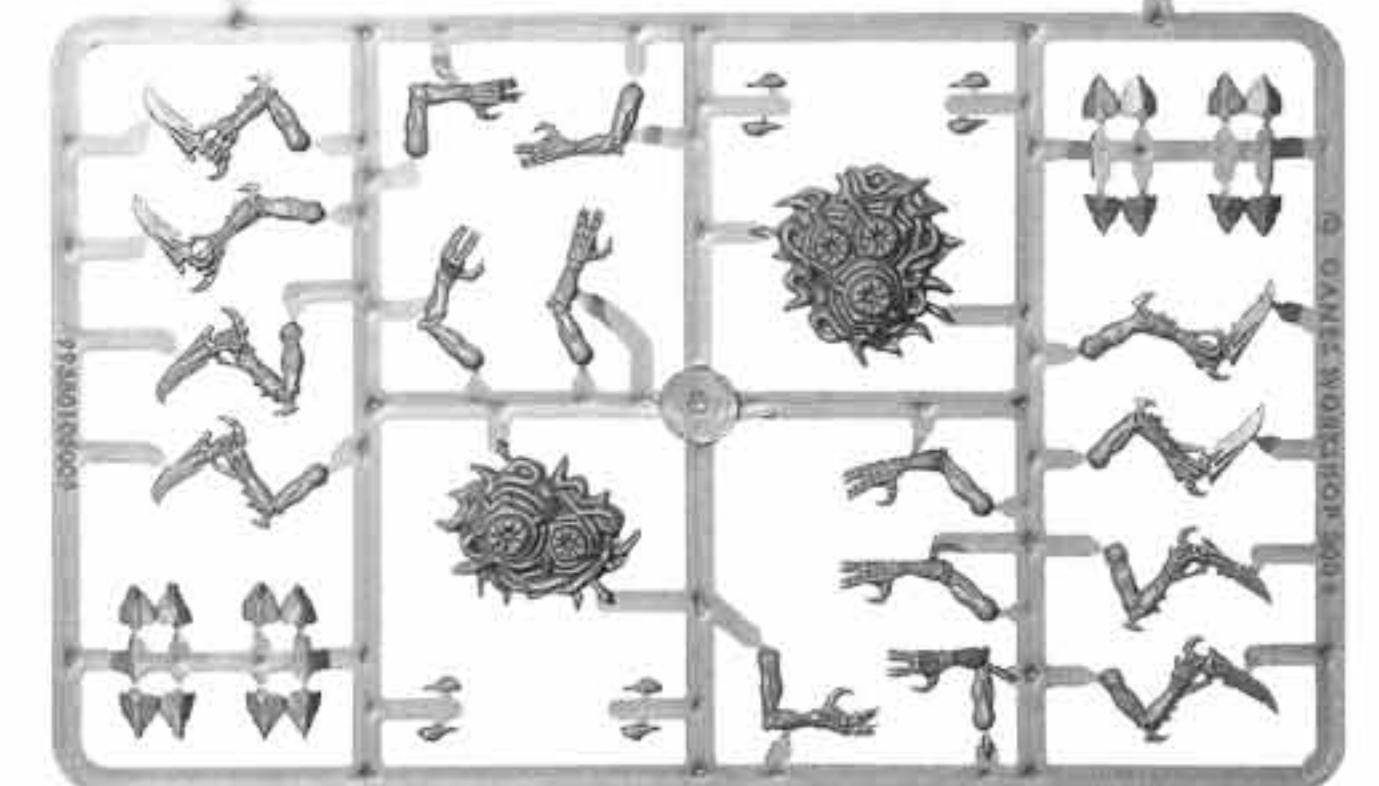
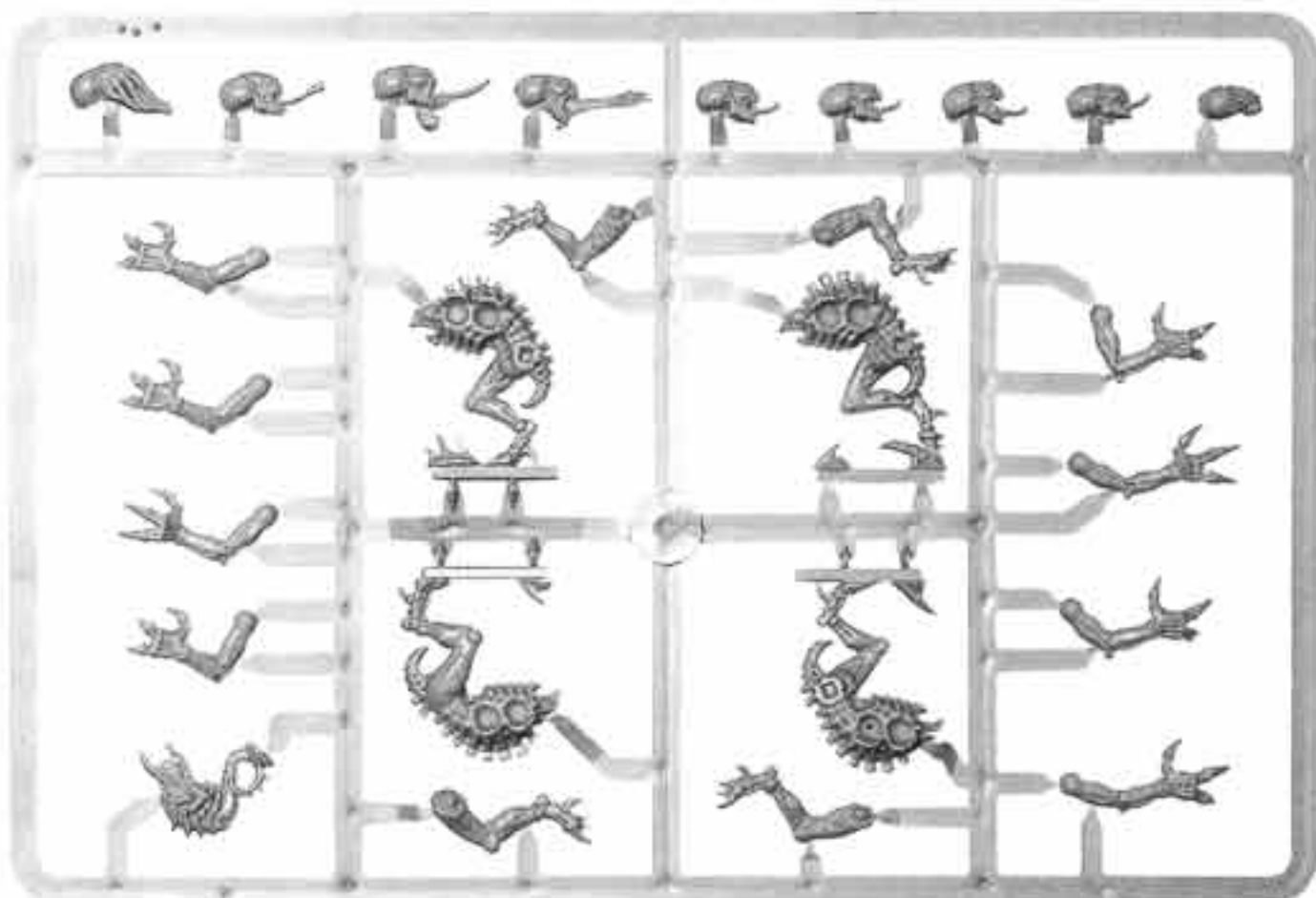

GENESTEALER SPRUE (SHOWN 55% ACTUAL SIZE)
99380106009



TROOPS



Tyranid Genestealers Box (8)
99120106007



TROOPS



Tyranid Gaunts Box (16)
99120106004

The Tyranid Gaunts boxed set includes the Biomorph Sprue (99380106003) shown in the HQ section.

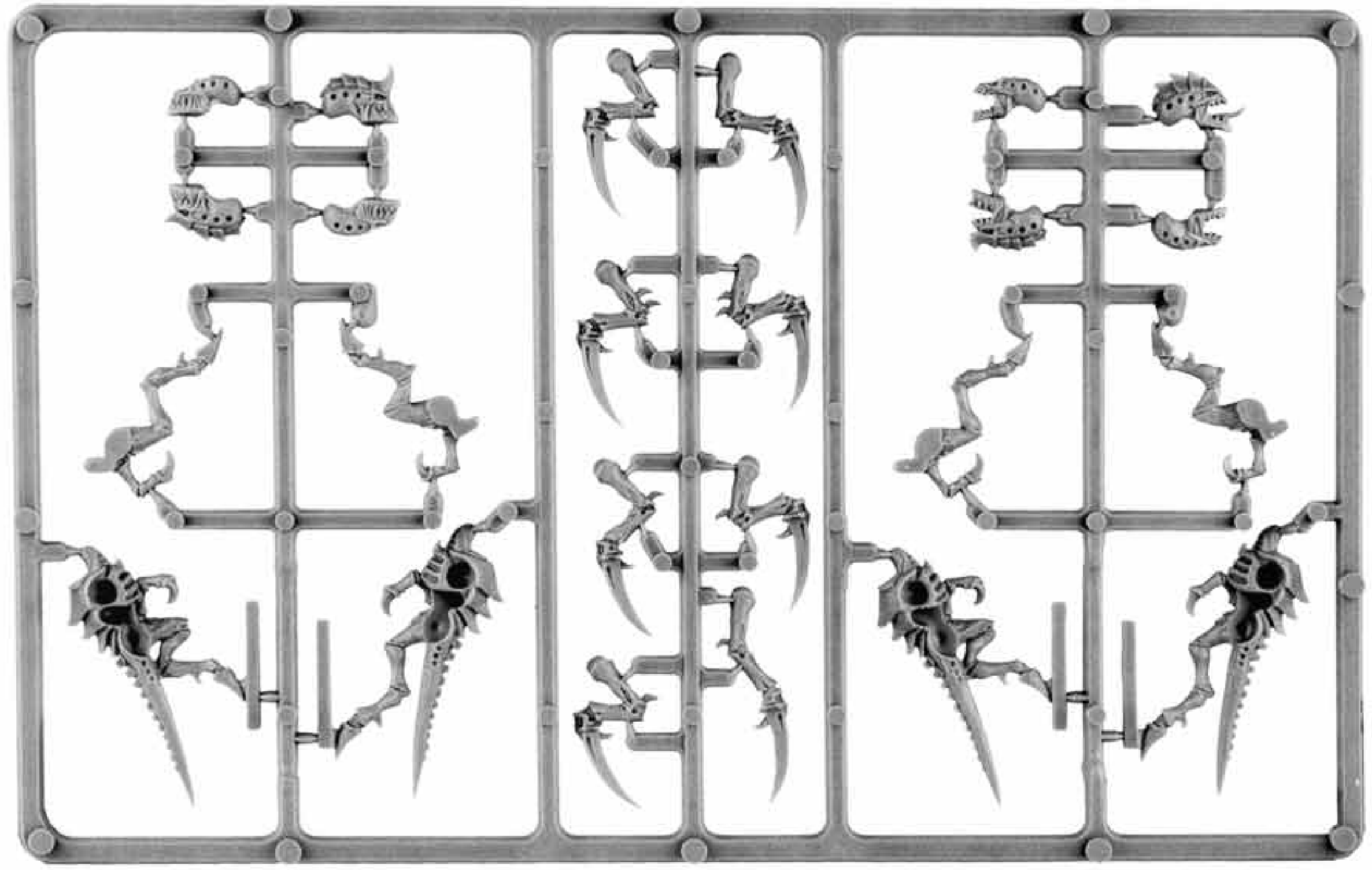

HORMAGAUNT SPRUE (SHOWN 90% ACTUAL SIZE)
99380106001



TROOPS

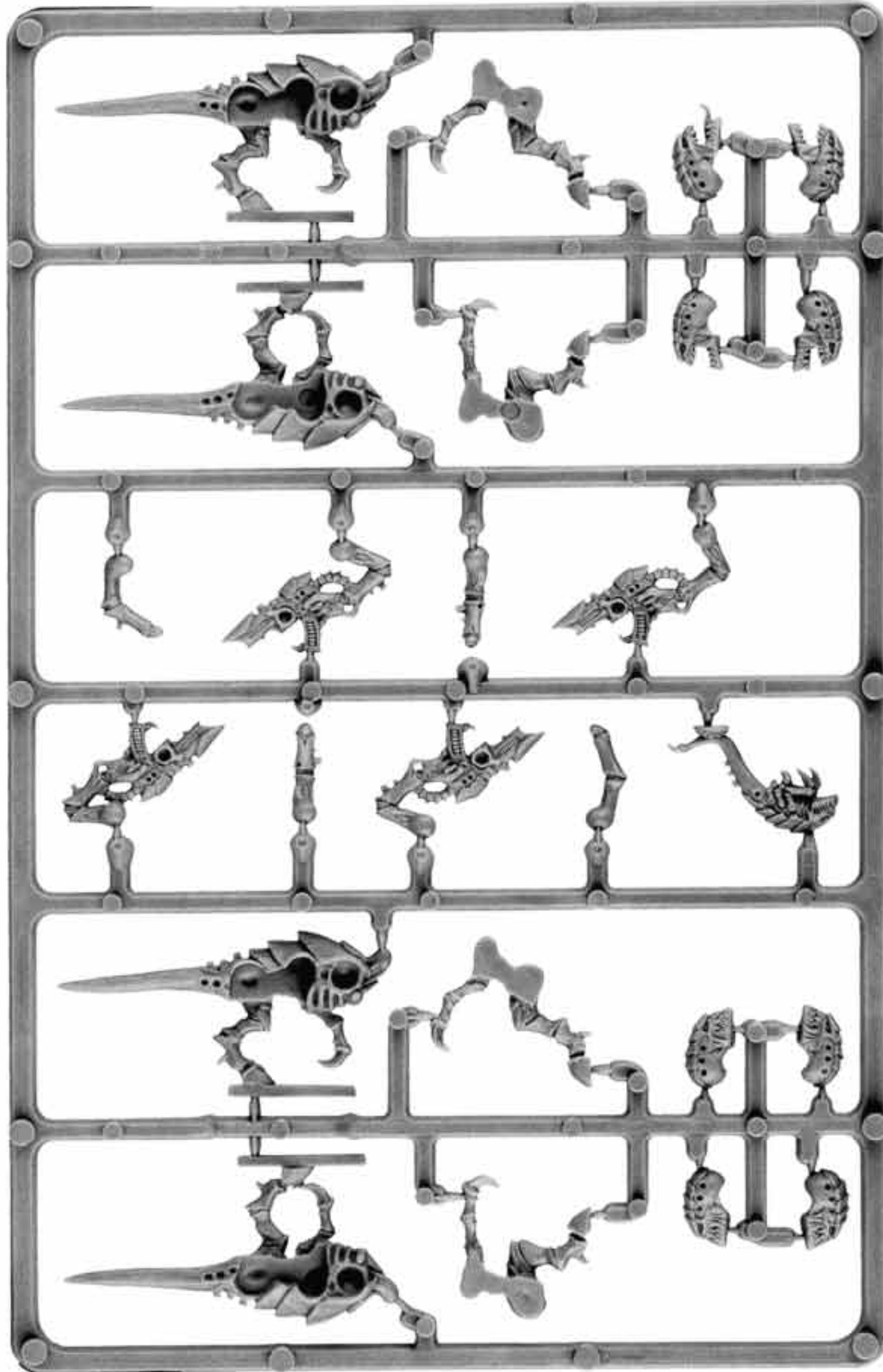

TERMAGANT SPRUE (SHOWN 95% ACTUAL SIZE)
99380106002

PAINTING TYRANIDS QUICKLY

Here, we'll show you a few techniques you can use to paint your Tyranids and get them ready for battle quickly. These techniques are simple to master, and you can achieve excellent results very easily.

There are any number of different painting styles you can use on your Tyranids, and each one is an equally valid method. There's no right or wrong way to paint your models, so use whichever method you find works best for you. You can paint your models with spray cans or drybrushing to achieve different but equally impressive results in your broods.

We'll also show you how to paint flying models and how to apply the same color scheme to a variety of different models.

DRYBRUSHING

To complete this model, we used a technique known as drybrushing. To drybrush your model, dip your brush into the highlight color and use a cloth to wipe most of the paint off of the bristles. Next, lightly draw the brush across the raised areas and edges of the model.

1. Undercoat your Gaunt with Bestial Brown.
2. Highlight it with Bubonic Brown.
3. Finally, apply the last highlights by drybrushing with Bleached Bone.

SPRAY CAN

Another method you can use to paint Tyranids quickly is to use light dustings of spray paint.

1. Spray the Gaunt with a basecoat of Bestial Brown.
2. Use a lighter, quicker spray of Bubonic Brown to lighten the raised areas of the model.





FAST ATTACK



Tyranid Gargoyles Blister (Random 2)
9906010603001



GARGOYLE BODY 1
9947010603001



GARGOYLE BODY 2
9947010603002



GARGOYLE BODY 4
9947010603004



GARGOYLE DEATHSPITTER
9947010603006



GARGOYLE BODY 3
9947010603003



GARGOYLE WINGS
9947010603005



Tyranid Ravener Blister (Random 1)
99060106046



RAVENER HEAD 1
9947010604601



RAVENER HEAD 2
9947010604602



RAVENER TAIL
9947010604604



RAVENER TORSO
9947010604603



RAVENER SPRUE 1
9947010604605



RAVENER SPRUE 2
9947010604606

All miniatures are supplied unpainted. Models, bits, and sprues are all shown actual size unless otherwise noted. Contents may vary slightly from those shown.

HEAVY SUPPORT



Tyranid Biovore Blister (4)
9906010603601



Tyranid Zoanthrope Blister (1)
99060106041





HEAVY SUPPORT



The Tyranid Carnifex boxed set (99120106010) contains enough bits to assemble one Carnifex. Multiple examples are shown to illustrate the numerous accessories included on the sprues.

Tyranid Carnifex Box (1)
99120106010

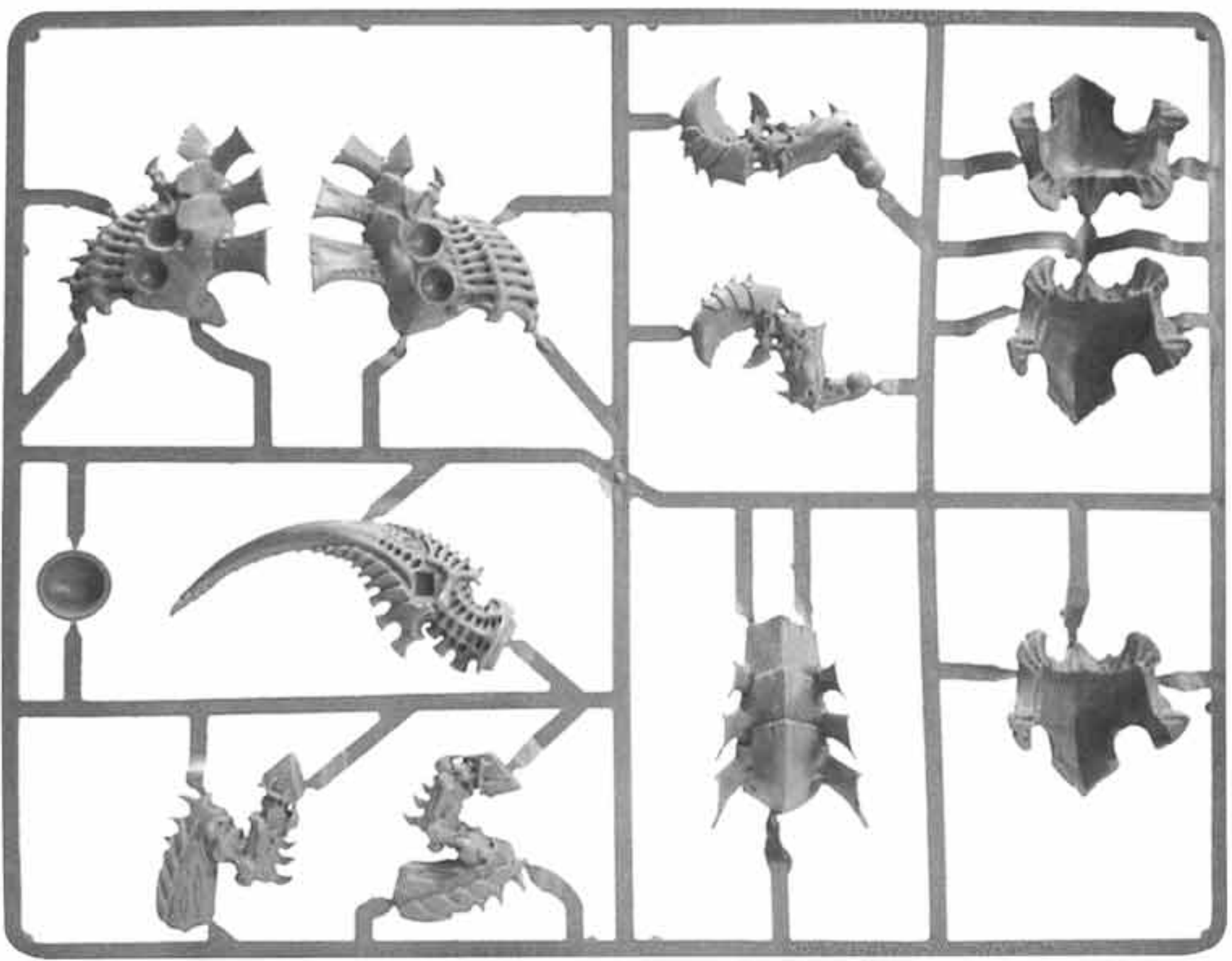

CARNIFEX SPRUE B (SHOWN 65% ACTUAL SIZE)
99380106011

All miniatures are supplied unpainted. Models, bits, and sprues are all shown actual size unless otherwise noted. Contents may vary slightly from those shown.

HEAVY SUPPORT

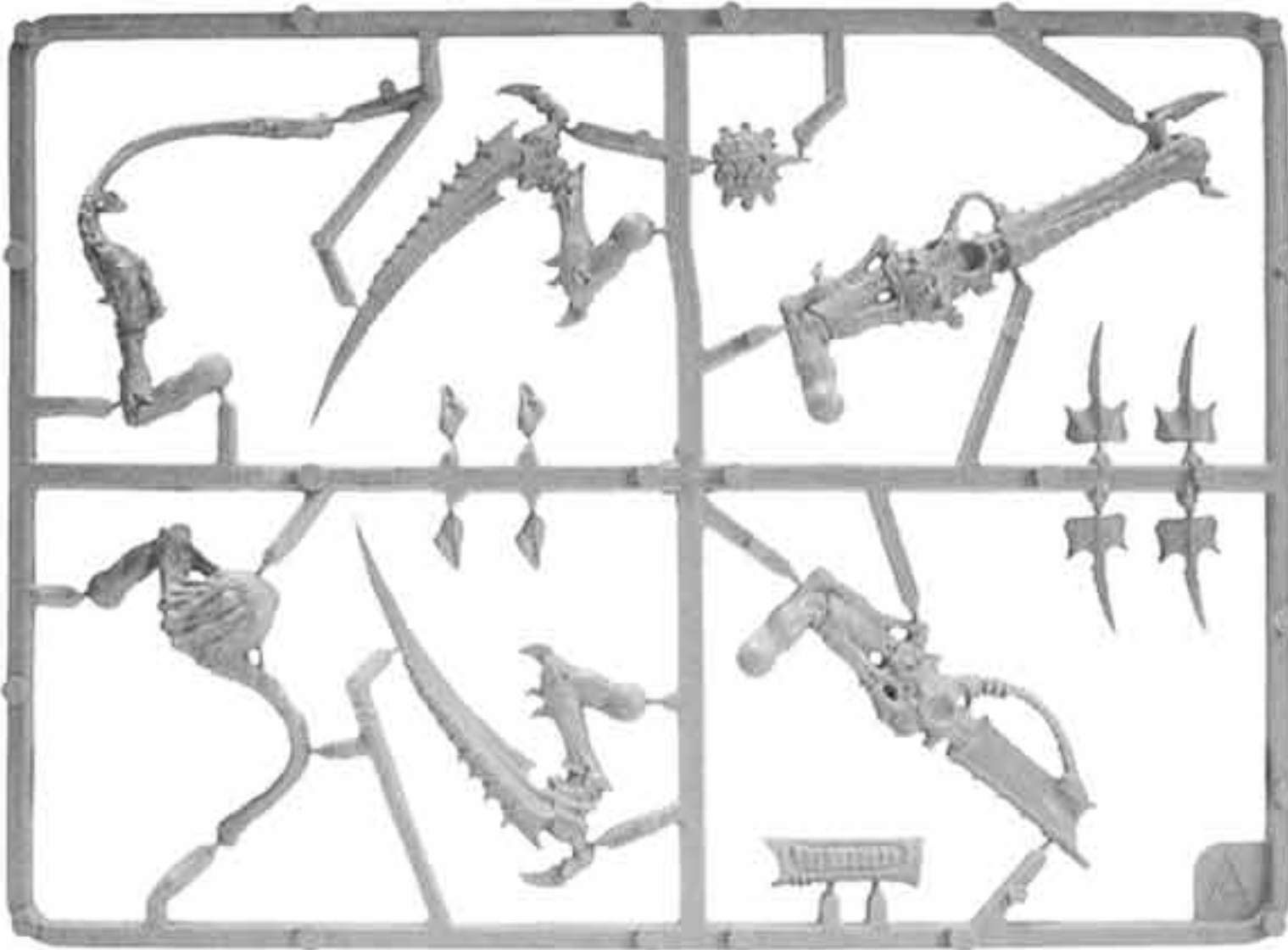

CARNIFEX SPRUE A (SHOWN 65% ACTUAL SIZE)
99380106010

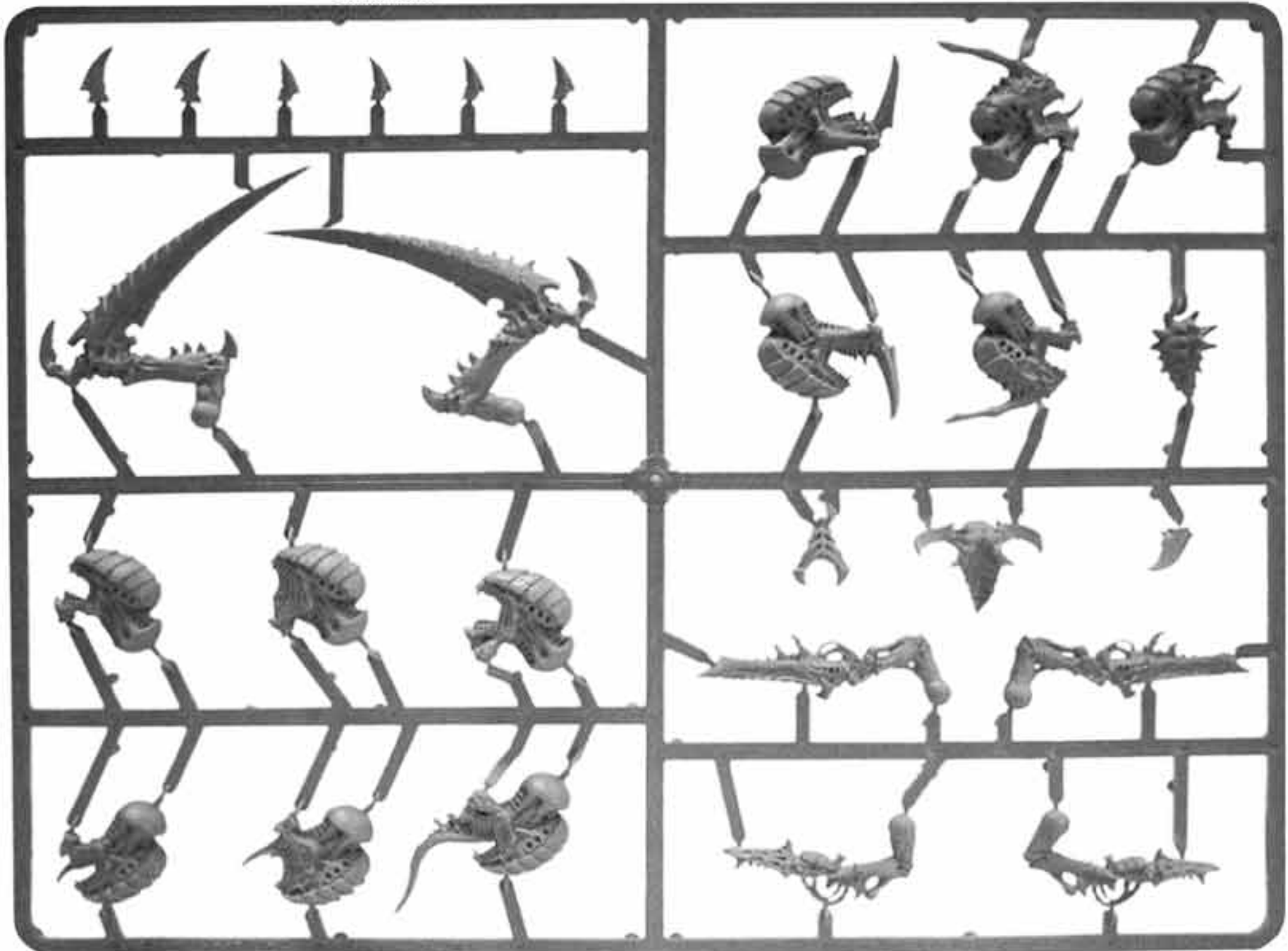

CARNIFEX SPRUE C (SHOWN 65% ACTUAL SIZE)
993801060012



TACTICS



TIPS FOR WINNING WITH TYRANIDS

- A. The Tyranid army really benefits in many ways when you take large broods. Using numbers to your advantage will help ensure you outnumber your opponent in assault. Don't fret at the large number of casualties you take in opening turns as you cross the table to engage your opponent – play aggressively, keep the pressure on, and don't get timid as you press the attack. Try to bring lots of broods – when setting up, if you have more units than your opponent, you will be placing several of them after he's done deploying and thereby gain a great tactical advantage.
- B. Tyranids have the capability to make almost any brood Leadership 10 or ignore the effects of Morale checks altogether. Synapse Creatures, when properly protected, can keep a Tyranid army advancing when even Space Marines would pull back. This ability can be critical in order to reach the enemy in the face of ordnance blasts, sniper fire, and psychic powers – all of which are often found on the battlefields of the 41st millennium.
- C. Speed is the Tyranid player's friend, especially in scenarios where you are claiming table quarters or objectives. Keep some speedy broods like Gargoyles and Hormagaunts tucked away ready to pounce in the last turns of the game just for this purpose; even basic Termagants can use the Fleet special rule to get into position quickly.



COUNTERTACTICS

TIPS FOR FIGHTING AGAINST TYRANIDS

- A. There are many ways to reduce the numbers of enemy units. Some of the best include heavy weapons fire, rapid fire weapons, and ordnance. When facing an army with many large units of models, sometimes the best response is to concentrate your own army on one side of the table. This way, you can put the maximum amount of your firepower on the units closest to you while forcing the units further away to take more time to reach your lines.
- B. Concentrate on the Synapse creatures. If you can take out enough of them, it can cripple the Tyranid advance. Pour on the massed firepower! When outside of Synapse range, Tyranid creatures fall back towards the nearest Synapse Creature, potentially creating a cluster of models perfect for templates.
- C. Although the "big ones" – Carnifexes, Tyranid Warriors, and Hive Tyrants to name a few – are often a favored target for heavy weapons fire, it is often more advantageous to focus your deadliest attentions upon the speedy parts of a Tyranid army. Once you eliminate the fastest Tyranids, you can begin to pick off the rest to avoid being overrun.

KEY
 ■ Top Box(es): Basecoat Colors & Ink Washes ■ Bottom Box(es): Highlights ■ Mixed Colors

COLORS OF WAR



Chaos Black & Hawk Turquoise
 Skull White, Blood Red



Chaos Black & Hawk Turquoise
 Blood Red, Tentacle Pink



Dark Angels Green & Regal Blue
 Hawk Turquoise, Blood Red



Scab Red
 Tanned Flesh & Bubonic Brown



Catachan Green, Bleached Bone
 Goblin Green, Warlock Purple



Red Gore, Terracotta
 Blood Red, Chaos Black



Chaos Black, Shadow Grey
 Skull White



Regal Blue, Dark Flesh
 Enchanted Blue, Blood Red



Chaos Black & Codex Grey
 Blood Red, Blazing Orange



Chaos Black, Bleached Bone
 Warlock Purple, Skull White



Chaos Black, Snot Green
 Scorpion Green



Scorched Brown, Red Gore
 Tanned Flesh, Blazing Orange



Dark Angels Green, Liche Purple
 Catachan Green, Bleached Bone



Regal Blue
 Liche Purple, Ultramarines Blue



Chaos Black & Dark Angels Green
 Snot Green, Bubonic Brown

All miniatures are supplied unpainted. Models, base, and options are all shown at actual size unless otherwise noted. Contrast may vary slightly from those shown.



SHOWCASE



Above: A Lictor stalking an Imperial Guardsman by Victoria Lamb.

Far Upper Right: Soufiane Yousfi's Hive Tyrant is a close combat monster, having evolved multiple sets of scything talons, flesh hooks, and wings!

Right: Chris Courtney brought these Winged Tyranid Warriors as part of his army at the 2005 Baltimore Grand Tournament.

Above: A Genestealer (top) and a Tyrant Guard (bottom) by Marco Schultze.
Far Right: A Broodlord by Dureke Sanchez.



All miniatures are supplied unpainted. Models, bits, and sprues are all shown actual size unless otherwise noted. Contents may vary slightly from those shown.

SHOWCASE



Left: A salivating Carnifex by Keith Robertson.

Above: A Genestealer by Marco Schultze.

Right: Dave Taylor's Lictor stalks its prey through the ruins of an Imperial city.



ALTERNATE MODEL – FAST ATTACK

Winged Warriors

COMPONENTS FOR 2 COMPLETE MODELS

- 99380106005 Tyranid Warrior Sprue (x2)
- 9947010603404 Lictor Left Arm (x2)
- 9947010603405 Lictor Right Arm (x2)
- 9947021205807 Dark Pegasus Rt. Wing (x2)
- 9947021205808 Dark Pegasus Lt. Wing (x2)

COMPLEXITY RATING



**THIS CONVERSION
CONTAINS THE SPECIAL
OFFER BITZ SHOWN HERE**
*See the catalog introduction
for more information.*



LICTOR RIGHT ARM
9947010603405



LICTOR LEFT ARM
9947010603404



WARHAMMER

Bring It to Your Tabletop

Warhammer is the game that allows you to bring all the excitement of fantastic battles right onto your tabletop. You take command of rank after rank of battle-hardened warriors and maneuver them to victory.

There are over a dozen different kinds of armies, from the hordes of the rat-like Skaven to the shambling Undead who rise from the grave to fight again. Every army has different abilities, troop types, and access to a vast assortment of unique monsters, magic, war machines, and more. Keen-eyed Wood Elf archers defend the forest, while cold-blooded Lizardmen try to reclaim their world with the aid of enormous reptile monstrosities. Even better, even the same army type can be assembled in countless different ways. One Dwarf army may rely on well armored infantry, while another tries for large batteries of war machines. In the end, the battle is won by the general who makes the best moves on the tabletop.

More Than a Game

Warhammer is not just a challenging game to test your tactics but also an entire hobby. Players can build armies, paint models, create new terrain, devise scenarios or special missions to play, and get involved in an ongoing league or campaign. Some hobbyists get involved in all the different aspects, while others settle on a few or even just one particular part. The following pages are all about getting started with the game and building your army.

There is nothing like playing a game with your own army. Over time, you can collect, paint, and assemble units into a mighty force. Then, you assume the role of general and lead your forces to victory (or curse the dice that betrayed you!). Win or lose, Warhammer is always fun.

All Levels of Gaming

The Warhammer rules allow great scope for gaming. Games can range in length from a quick half an hour skirmish with a dozen or so models per side to massive battles between dozens of players, each commanding his own sizable army. The objectives of each game can be as simple as "wipe out the other side" to complicated scenarios or ongoing campaigns that last days, weeks, or even years.

Players can build "official" armies with the Warhammer Armies books, or they can happily design or "make up" their own additional rules, models, monsters, and

more. The only real limit is your imagination and the amount of hobby time you can find.

Is There a Right Way to Choose an Army?

Before we get too deep into the prospect of selecting an army, it is worth noting that there is no single right way to choose one. Pretty much anyway you end up with an army is a right way, and the only wrong way to collect an army is when you don't end up with a force you can play with!

However, the following advice may help players who can't make up their minds.

Getting Started

Some lucky players know immediately which army they want to collect. Perhaps they have seen some games in action or spoken with an experienced friend, or maybe the gaming club they hope to join has no representatives for a certain army type. Other prospective players have no idea or perhaps have ruled out a few choices but are no closer to making an selection. This page and the next can help you reach a decision about which army to start.

Getting all the information you can about the armies that you find appealing is always a good first step. This catalog is an excellent start, and the Games Workshop web site is also a valuable resource.

There may be a number of criteria for player's choosing their armies, but here are some of the ones we talk about most often: style of play, background, and the miniatures. Each of these topics deserves closer inspection.

Background

Warhammer has a rich and well developed background. Each army has its own history, realm, and goals. Many players can't get into an army unless they think the background is equally cool. In a sense, the Warhammer world is an ongoing story, and players can get involved in the tale by playing games.

For example, the Dwarfs used to be a very prolific and powerful race. After a long (and some would say misguided) war against the High Elves, a great eruption of Chaos overcame the land. The earthquakes and volcanoes damaged or destroyed many of the Dwarfen mountain realms, and still more were invaded by tunneling bands of Skaven and Night Goblins. All these calamities dealt the Dwarfs a blow from which they have never recovered. Although still powerful in certain strongholds, the Dwarfen race has but a shadow of its former glory.

Still, glimmers of hope remain, and the fire of revenge burns brightly in every Dwarf. Revenge, loyalty, and bitterness are all common themes to a Dwarf! One by one, the Dwarfs ancestral homes will be reclaimed, or so the Dwarfs vow.

Each section that details a Warhammer army in this catalog begins with some background information that will give players a taste of what the army is all about.

Style of Play

Each army in Warhammer is different and will be better at different things on the tabletop. Matching up the army's style with what a player enjoys most is the goal. If no-holds-barred blitzing offense sounds good to you, perhaps a mortal Chaos army would fit? If lots of magic and raising Undead sounds appealing, then Vampire Counts may be for you. Superior numbers, back-stabbing, and nefarious war machines are deep in the black heart of any Skaven General!

It is possible to achieve some or even all of these tactics with the same army, but every force has strengths and weak points.

As an example, an Orc & Goblin army can be very diverse and may be built around infantry (Big'Uns and Black Orcs), cavalry (Wolf Riders and Boar Boyz), war machines (Rock Lobbers, Chariots, and Bolt Throwers), magic (spells of the Big Waaagh! are very potent), wacky special weaponry (Night Goblin Fanatics), and more. Some wily commanders even choose several of these options when assembling their force. No matter what the greenskin warlord chooses, it tends to be a bit unreliable. Orcs & Goblins suffer from Animosity and low Leadership.

In this catalog, players can find out more by reading the Fighting Style section listed with each army.

Finding out More

Once you've found an army or two that really capture your interest, it's time to find out more. The Games Workshop web site is ideal for this sort of research, and you'll find information about every army. Finding and talking to a local gaming group is always a great idea. After all, the members may be some of the opponents you'll be squaring off against with your new army in the future. Try asking for times when players meet at your local Rogue Trader Independent Retailer or GW Hobby Center.

WARHAMMER



Miniatures

Many players choose armies based strictly on the look of the model range. Since collecting and painting play such a large part in the Warhammer hobby, choosing a force based on looks is a sensible option. After all, the more you like and enjoy the models, the more you'll have fun in the collecting, painting, and modeling aspects of the hobby.

This catalog is ideal as it allows players to ogle the entire range of models for each army.

The Army Book

Once you've decided on an army, the appropriate Warhammer Armies book is the next logical step. The Army book will go into detail about the force and allow players to build armies far beyond the description in the basic rulebook.

Each Army book contains a complete army list, with descriptions of every unit, war machine, weapon type, and magical item available to the force. Additional background and history are included as are the profiles for some special characters and the special rules for your army of choice.

Collecting Models

The easiest way to start collecting your army is to buy and paint the most eye-catching

models in the range first. This desire is understandable. However, though a hero on a Griffon, a Steam Tank, and Wizard may be formidable, they are not an army! Thus, it makes sense to balance the force as you go.

The army lists in each Warhammer Armies book are divided up into four basic sections: Lords & Heroes, Core troops, Special troops, and Rare troops.

In the Warhammer part of this catalog, under Collecting an Army at the start of each force's section, we list a few suggestions about how to begin purchasing each army. No matter what size game you are playing, the normal minimums are a character model (to lead your forces) and at least two Core choices. For players just beginning, a force like this one is always a great place to start. In Warhammer, Core troops tend to take the form of plastic regiment sets. These enable players to gather a small horde quickly, easily, and relatively affordably.

The ideal goal of each veteran player is to have lots of choices. A standard tournament-style game involves armies of around 2,000 points and can include 0-2 Rare units. However, the ideal army has more than 2 Rare units! This range of choices allows players to switch their armies or to gear up for tough opponents. Having the ability to take two Giants in an Orc army, for instance, is very threatening!



There are plenty of armies to choose – from the Lizardmen of the steaming jungles of Lustria to the armies of the frozen and mountainous Ogre Kingdoms. There is an army for you that is both aesthetically pleasing and tactically flexible!

Choosing an Army

Each Warhammer Army book is set up in the following order: Lords & Heroes, Core, Special, and Rare units. That is also the order in which the catalog will present each type of model for each army in the current range.

Lords & Heroes. These models represent individual characters and can include such personalities as Generals (or Warlords, Lords, Daemon Princes, or whatever leads your particular army), Heroes, Wizards, and specialty characters unique to each army (like Warrior Priests in the case of the Empire).

Core Troops. Core units represent the most common warriors in any army. They usually form the bulk of the force and will often bear the brunt of the fighting. Every army must field at least a few Core units.

Special Troops. These are the best of the army's warriors as well as certain war machines or Chariots. These troops tend to have the best arms and armor and are available only in limited numbers.

Rare Troops. Rare troops are so called, because they are very scarce compared to ordinary warriors. This category includes uncommon monsters, unusual war machines, and unique units of extraordinary power.

Troops are categorized into Core, Special, and Rare units. The number of each type of unit available depends on the army's points value, as indicated on the chart below.

Army Points Value	Core Units	Special Units	Rare Units
Less than 2,000	2+	0-3	0-1
2,000 or more	3+	0-4	0-2
3,000 or more	4+	0-5	0-3
4,000 or more	5+	0-6	0-4
Each +1,000	+1 minimum	+0-1	+0-1

In some cases, other limitations may apply to a particular kind of unit, and these are specified in the Warhammer Armies books. For example, the Furies entry in the Hordes of Chaos Army book lists 0-1, meaning that you can have a maximum of one of these units in your army, regardless of its points size.



Warhammer Fantasy Rulebook
60040299004

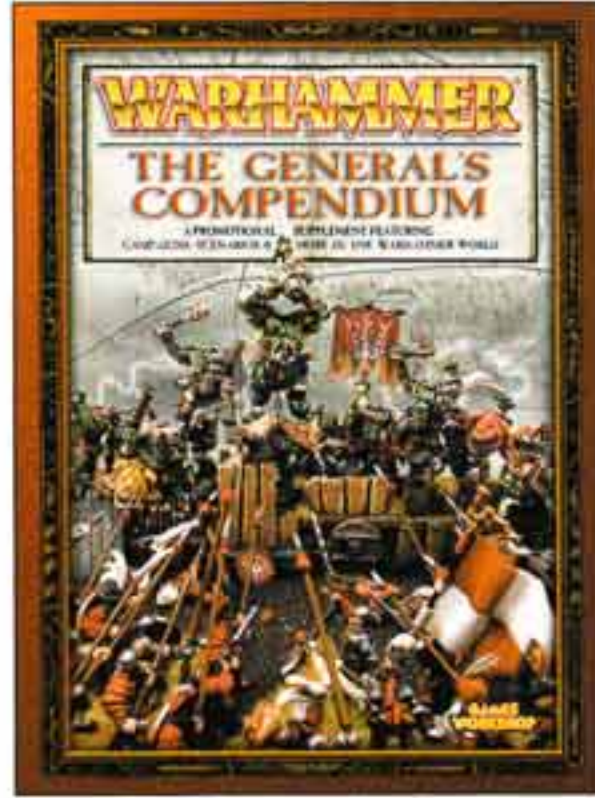

Warhammer General's Compendium
60040299017

GETTING STARTED

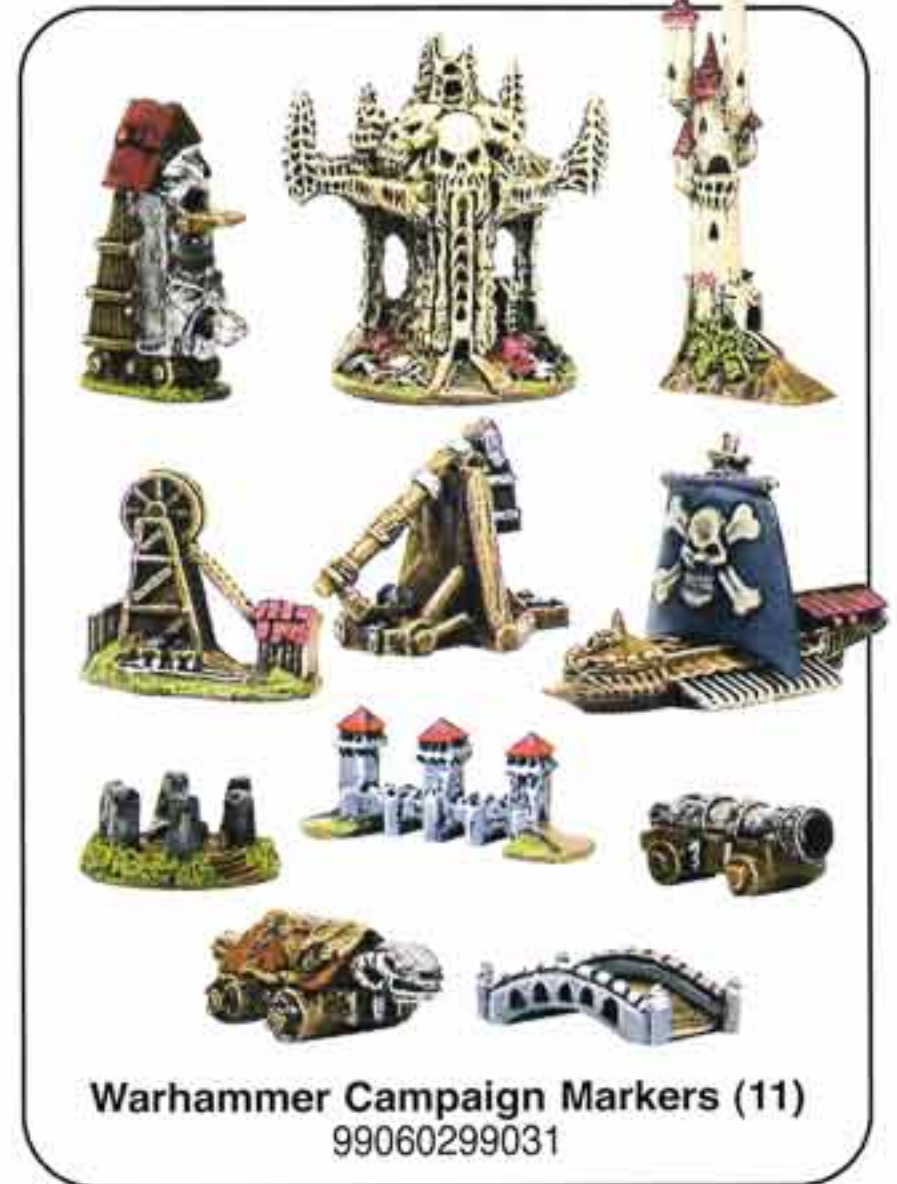

Warhammer Campaign Markers (11)
99060299031



Below: The Warhammer box is a great way to get started with Warhammer. Everything you need to get started right away is included – figures, dice, rules, even a ruined building terrain piece. This box has it all! If you are looking to learn how to play Warhammer, this set is for you!



The Warhammer Boxed Game (contains rules, dice, templates, range rulers, 35 Orcs, 1 Orc Warboss, 1 Orc Chariot, 38 Empire Soldiers, 1 Empire Hero, 1 Cannon, and ruined building terrain)
600102991

BEASTS OF CHAOS

Riding at the head of the column, Captain Schmidt cursed his bad luck and scanned the still forest for signs of trouble. Like a clerk checking off his inventory, Schmidt ran down his list of troubles: the merchant convoy was late on its journey from Middenheim to Hochland; he and his men were in a particularly black part of the Drakwald forest; and the air was bitterly cold, making the trek even more unpleasant. To make things bleaker still, small flurries of snow fell from an ever-darkening sky.

Rising above the growing wind, the stamp of horses, and the huddled talk of worried merchants, a horn brayed from the forests, its unwholesome sound echoing through the woods. To the front, Schmidt could pick out dark figures working their way quickly through the forest. From the rear of the column came the sounds of steel on steel, panicked shouts, and the bestial grunts of inhuman opponents. There was no time to set up a formation, and already the foe was among the horses and baggage.

"Beastmen ambush! Draw your swords and form up on the road," shouted Captain Schmidt. Something immense was hurtling through the forest, uprooting great trees, and cracking through vast branches as it came.



This Pestigor unit by White Dwarf Graphic Designer John Shaffer took top honors at the 2003 Staff Golden Demon competition.

Deep within the dark heart of the most twisted and dangerous forests of the Old World reside the countless hordes of Beastmen, the true children of Chaos. These wild herds are made up of beast-headed and bloodthirsty creatures. Striking without warning, the barbarous beasts are a plague on the civilized world. Who knows what evil eyes watch from the dark woods, and who knows when the next murderous raid will be launched?

Fighting Style

The Beasts of Chaos form a varied army with some powerful (and disturbing) units at its disposal. With fearsome abilities in close combat and few missile troops, the goal of

every Beasts of Chaos army is to close quickly with the enemy. Special *Ambush* rules and deployment allow some units to enter from any table edge – always a worrying factor for your opponent. However, even if the Beasts of Chaos are not advancing upon flanks or rear, the army moves quickly (Movement 5 at the worst!) and, with the *Raiders* special rule, may easily navigate through terrain without penalty. You can't hide behind terrain or in the woods against an army that flows through scenery as quickly as the Beasts of Chaos do. Once in combat, the Beasts of Chaos are tough and are supported by a hard-hitting and gruesome creatures like Chaos Trolls, Centigors, Minotaurs, Dragon Ogres, and more. Swift Tuskgor Chariots and Warhounds of Chaos are ideal for menacing flanks, or they can be the first to charge for frontal assaults.

Collecting a Beasts of Chaos Army

For players intent on building a Beasts of Chaos army, the best starting place is a Beast Herd. Not only does this unit fulfill one of the minimum number of Core troops for an army, but Beast Herds are also the mainstay of the army. For additional Core choices, players may choose from Warhounds of Chaos (speedy flanking units), Tuskgor Chariots (very hard-hitting), or a Bestigor Herd (limited to the number of Beast Herds). Larger Beasts of Chaos armies will also want more Beast Herds, as the more of these invaluable troops you have, the more that can *Ambush*. The other requirement, besides Core troops, is a leader. Beasts of Chaos may go with Beastmen Lords or Heroes, Doombulls (a Minotaur Hero), or Beastmen Shamans.

When enlarging a Beasts of Chaos force, there are a number of fantastic options. Centigors are fast and make ideal flanking units. Small but brutish units of Chaos Trolls, Chaos Ogres, Dragon Ogres, and Minotaurs can all deliver potent and relatively speedy charges. The ancient Dragon Ogre Shaggoth is extremely points-heavy but is its own maelstrom of destructive and *Terror*-causing power. Chaos Giants may be selected, and Spawn make interesting and *Unbreakable* options as well.

There are many options and ways to tailor the Beasts of Chaos for your specific tactical needs, so sound the Brayhorn and gather your warherd.



Joe Hill took home top honors for the Warhammer Single Miniature in the 2003 UK Golden Demon Competition with this Beastman Shaman.

GETTING STARTED

The army shown here is a 1,000-point force. This army is a good indication of where to start if you are looking to collect a Beasts of Chaos army. It consists of a Wargor, a Battle Standard Bearer, two 20-strong Beast Herds, 20 Pestigors, 10 Warhounds of Chaos, and 2 Chaos Spawn.



This 80-page rulebook contains background, painting and modeling tips, and complete rules for fielding an army comprised solely of Beasts of Chaos. This valuable book is also a supplemental guide to Warhammer Armies: Hordes of Chaos.



**Warhammer Armies:
Beasts Of Chaos**
60030201003

While Beastmen can be mutated into other forms depending on the power of Chaos they're devoted to, there's always a need for Truegors (the name for Beastmen with no further mutations) in any Beasts of Chaos army. And if you're looking to assemble a herd of cloven-hoofed minions of the dark gods, the best way to start out is with the Chaos Beastmen Regiment boxed set. It contains enough plastic bitz to make 20 Beastmen, and they can either be equipped with a hand weapon and a shield or go completely aggressive with two hand weapons. Either way, you'll be on your way to an army in no time flat.



Chaos Beastman Regiment Box (20)
99120201005



Beastman with a hand weapon and shield



Beastman with two hand weapons



Regiment shown at approximately 95% of actual size.



LORDS & HEROES



MORGHUR BODY
9947020116902



MORGHUR RIGHT ARM
9947020116903



MORGHUR LEFT ARM
9947020116901



Morghur, the Master of Skulls Blister (1)
99060201169



Khazrak the One-Eye Blister (1)
99060201168



KHAZRAK THE ONE-EYE
9947020108001



KHAZRAK HEAD
9947020116801



KHAZRAK WHIP
9947020116802



BRAY SHAMAN 1
9947020100401
BRAY SHAMAN 2
9947020100402
Bray Shaman Blister (Random 1)
99060201004



CHAOS BEASTLORD 2
9947020116104
CHAOS BEASTLORD 1
9947020116103
Chaos Beastlord Blister (Random 1)
99060201161



BEASTLORD 1 BODY
9947020116102



BEASTLORD 1 LEFT AXE
9947020116101



BEASTLORD 1 RIGHT AXE
9947020116103

LORDS & HEROES



Gorthor the Beastlord and Chariot Box (1)
99110201151



GORTHOR CHARIOT TUSKGOR HEAD 1
9947020108413

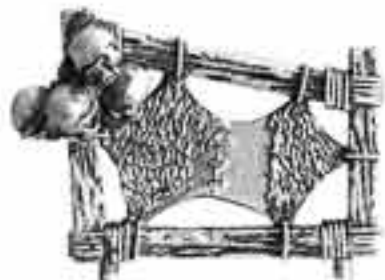

GORTHOR CHARIOT SIDE 1
9947020108411



CHARIOT YOKE
9947020106705



GORTHOR BEASTLORD TROPHY RACK
9947020108404



CHARIOT CREW 2
9947020115003



GORTHOR CHARIOT TUSKGOR HORNS
9947020108416



GORTHOR CHARIOT SIDE 2
9947020108412



GORTHOR BEASTLORD SPEAR
9947020108403



CHARIOT DRIVER SPEAR
9947020115004



GORTHOR CHARIOT TUSKGOR JAW
9947020108414



GORTHOR CHARIOT SKULL
9947020108409

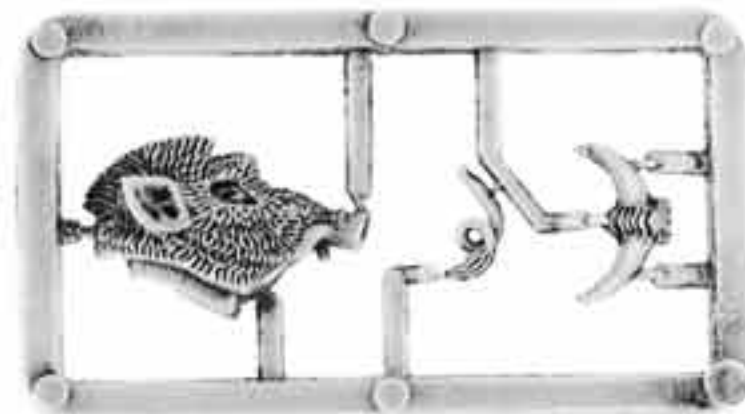

BOAR HEAD SPRUE
99389999017



GORTHOR CHARIOT TUSKGOR HEAD 2
9947020108415



GORTHOR CHARIOT BASE
9947020108410



SOLID WHEELS SPRUE (SHOWN 75% ACTUAL SIZE)
99399999058



BOAR BODY SPRUE
99389999009



LORDS & HEROES

PAINTING BEASTMEN FLESH



Begin with a Bestial Brown undercoat. Paint and drybrush the fur in your desired colors. Next, mix up a 75/25 mix of Bestial Brown and Bleached Bone. Apply this mix over the majority of the skin but leave a slight amount of the Bestial Brown showing through in the most recessed areas. For the next highlight, make a 50/50 mix of Bestial Brown and Bleached Bone and apply the highlight a bit more sparingly than the previous coat. The final highlight is a 25/75 mix of Bestial Brown and Bleached Bone. This highlight should be applied only to the most raised ridges and pronounced muscles.



Apply a basecoat of a 50/50 mix of Liche Purple and Tanned Flesh. This basecoat will yield an interesting color for your flesh. Apply a highlight of straight Tanned flesh. Leave the basecoat color in the most recessed areas. Apply a second highlight of straight Dwarf Flesh. Again, make sure a hint of the previous highlight color shows on the flesh areas. Apply the final highlight of Elf Flesh on top of the Dwarf Flesh you just painted. Paint thin lines to suggest musculature and blend the highlight color on the larger areas (like pectoral muscles/shoulders) for added realism.



Start with a Chaos Black undercoat. The first highlight should be a 50/50 mix of Scorched Brown and Codex Grey. Add more Codex Grey for successive highlights. The final highlight should be straight Codex Grey. This approach will produce dramatic shading that will look great on the tabletop.



Minotaur Lord Blister (1)
99060201045



MINOTAUR LORD HEAD
9947020104501



MINOTAUR LORD BODY
9947020104503



MINOTAUR LORD LEGS
9947020104505



MINOTAUR LORD SHOULDER
9947020104504



MINOTAUR LORD JAW
9947020104502



MINOTAUR LORD LEFT ARM
9947020104506



MINOTAUR LORD RIGHT ARM
9947020104507



CORE UNITS



Chaos Beastman Regiment Box (20)
99120201005

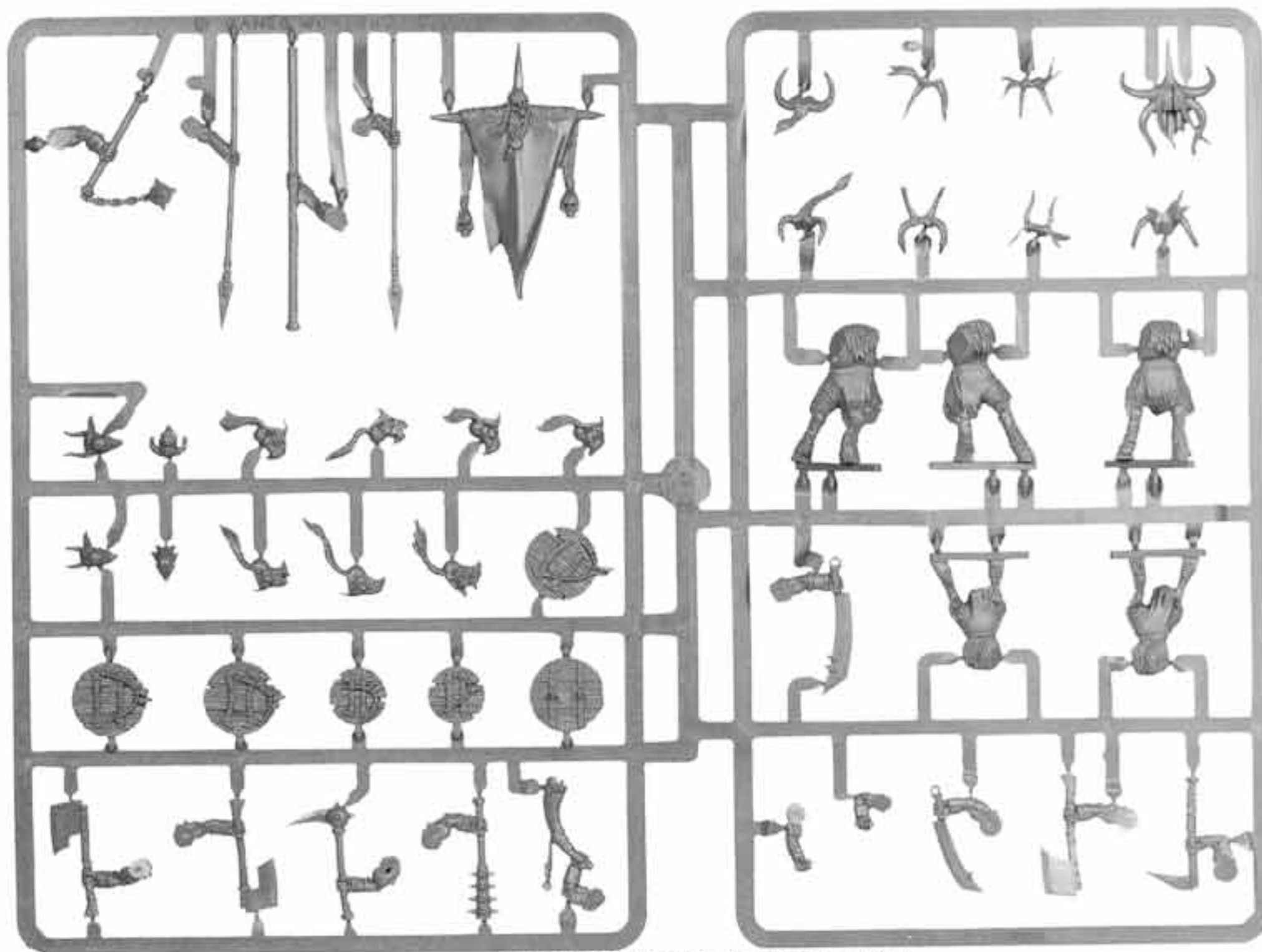

BEASTMAN REGIMENT SPRUE (SHOWN 65% ACTUAL SIZE)
99380201013



CORE UNITS

PAINTING HORNS



Here's a rather quick way to paint horns. All three methods discussed here begin with a Chaos Black undercoat. Begin by drybrushing the entire model Scorched Brown. Next, paint the horns Bubonic Brown. Apply a Chestnut Ink wash over the horns to give depth. Paint Bubonic Brown on the raised parts of the horns. Highlight with Bleached Bone on the tips of the raised areas.



This method takes a more time but has an attractive, rich appearance. Drybrush the entire model Scorched Brown. Paint the horns Bestial Brown but leave the recessed areas dark. Mix up equal parts of Bestial Brown and Bubonic Brown and paint the raised areas. Add Bleached Bone to your mixture from step 2 and paint the raised areas. Highlight with Bleached Bone on the tips of the horns.



For cracked, weathered horns, try this method. Drybrush the model Scorched Brown. Paint the horns Bestial Brown. Decide where your cracks will be. They can be put anywhere except for raised areas. Follow your pattern with Bubonic Brown but leave a small amount of Bestial Brown showing. Highlight the Bubonic Brown areas with Bleached Bone.



Tuskgor Chariot Box (1)
99110201150



CHARIOT CREW 1 AXE
9947020115002



CHARIOT SIDE 1
9947020106707

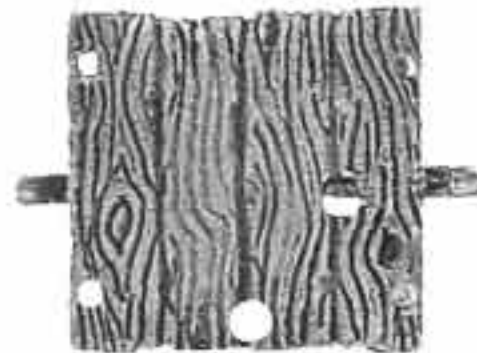

CHARIOT BASE
9947020115005



CHARIOT SIDE 2
9947020106708



CHARIOT CREW 1
9947020115001



SEVEN-SPOKED CHARIOT WHEELS
(SHOWN 75% ACTUAL SIZE)
99399999001



TUSKGOR 1 HEAD
9947020106710



TUSKGOR 1 JAW
9947020106711



TUSKGOR 2 HEAD
9947020106713



TUSKGOR 2 HORNS
9947020106712

The Tuskgor Chariot also comes with the following components that are shown with Gorthor the Beastlord in the Lords & Heroes section: Chariot Yoke (9947020106705), Chariot Haft (9947020106706), Beastman Chariot Crew 2 (9947020115003), Beastman Chariot Spear Arm (9947020115004), Boar Body Sprue (99389999009), and Boar Head Sprue (99389999017).

CORE UNITS



Chaos Pestigors Box (10)
99110201149



PESTIGOR STANDARD TOP
9947020116502



PESTIGOR STANDARD BEARER
9947020116501



PESTIGOR STANDARD BEARER



PESTIGOR MUSICIAN
9947020116503

Pestigor Musician and Standard Bearer Blister (2)
99060201165



Pestigor Champion Blister (1)
99060201148

BIT NAME: PESTIGOR CHAMPION
BIT CODE: 9947020114801



PESTIGOR 4
9947020114904



PESTIGOR 1
9947020114901



PESTIGOR 2
9947020114902



PESTIGOR 3
9947020114903

MODELING FLESHY BANNERS OUT OF PUTTY



Roll chunks of green stuff into cylinders, place them inside a plastic bag, and smash them flat between two books. Next, take a hobby knife and segment the surface so it appears like pieces of flesh sewn together. Drawing lines with repeated stippling motions will yield the best results.



After the putty has dried, remove the flattened pieces of green stuff and draw out your banner shape with a magic marker. Use the lines as a guide and cut out the shape with a hobby knife.



To attach, drill holes through the banners into the banner pole with a pin vise. Glue a section of paper clip to the banner pole, put some super glue on the back of the banner near the hole, then slip the banner over the paper clip.



Painting the flesh sections different shades will help strengthen the patchwork appearance. Runes, markings, and hand prints can then be painted inside of each section for an extra level of detail.



CORE UNITS



Bestigor Regiment Box (Random 10) & Command Blister (3)
99110201053 99060201054



BESTIGOR 1
9947020105301



BESTIGOR 2
9947020105302



BESTIGOR 3
9947020105303



BESTIGOR STANDARD BEARER
9947020105403



BESTIGOR STANDARD TOP
9947020105404



BESTIGOR MUSICIAN HORN
9947020105402



BESTIGOR MUSICIAN
9947020105401



BEASTMEN CHAMPION 1
9947020100301

CORE UNITS



Khorngor Champion Blister (1)
99060201155
BIT NAME: KHORNGOR CHAMPION
BIT CODE: 9947020115501

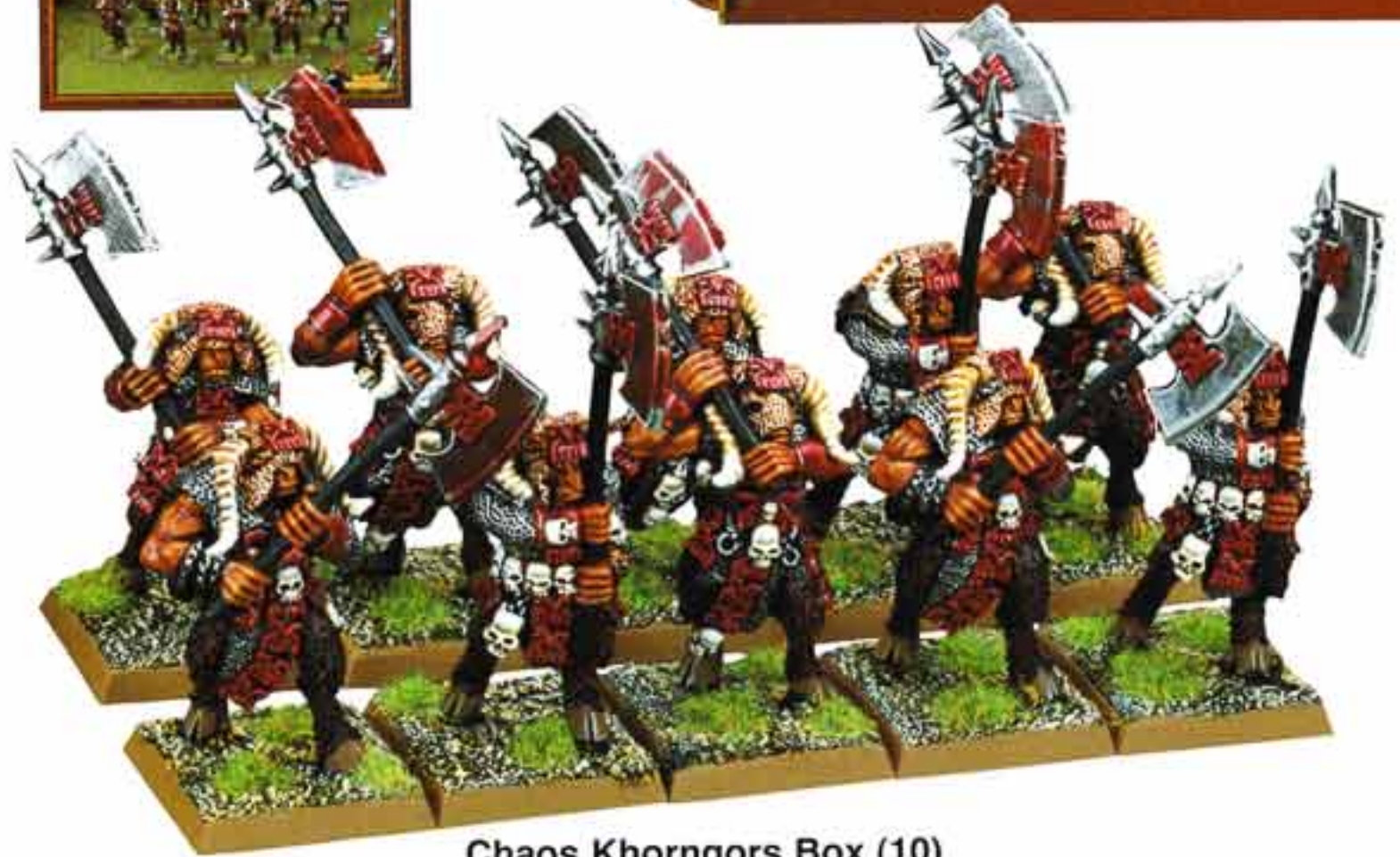

Chaos Khorngors Box (10)
99110201154



KHORNGOR STANDARD BEARER

KHORNGOR MUSICIAN
9947020116703

Khorngor Standard Bearer and Musician Blister (2)
99060201167



KHORNGOR 2
9947020115402

KHORNGOR 3
9947020115403

KHORNGOR 1
9947020115401

KHORNGOR 4
9947020115404



CHAOS KHORNGOR STANDARD
9947020116702



KHORNGOR STANDARD BEARER
9947020116701



SPECIAL UNITS

CONVERTING CHAOS CENTIGORS



Begin by snipping the buckler forearms off of the Centigor's left side behind the wristband. Next, cut the forearm from a left arm off of the plastic Beastmen sprue. Pin the arm in

place and smooth the join with modeling putty.

Simply glue a plastic Beastmen shield to the plastic arm. You can leave the shield off until painting is complete. The shield should hide any rough cutting done to remove the Centigor buckler arm in the previous step.



Kroot accessories are great additions to your Centigors. The knives in particular are an easy way to model the throwing axe upgrade available to the unit.



An example of a completed conversion



Chaos Centigor Regiment Box (5) 99110201166
Chaos Centigor Blister (Random 1) 99060201156

The Centigor Regiment boxed set includes all of the bits shown below and those to the right. The standard, horn, and champion spear are not available in the Centigor blister packs.

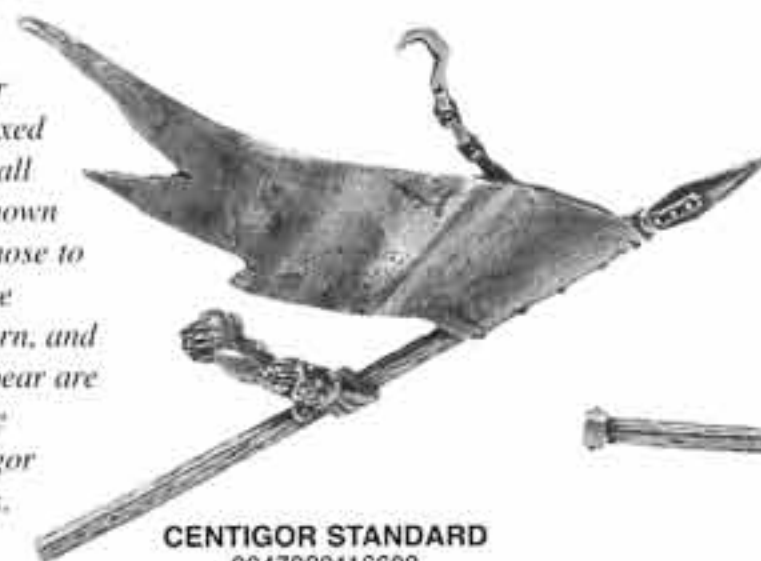

CENTIGOR STANDARD
9947020116608



CENTIGOR HORN
9947020116609



CENTIGOR CHAMPION SPEAR
9947020116607



CENTIGOR LEFT BODY 1
9947020116601



CENTIGOR LEFT BODY 2
9947020116602



CENTIGOR LEFT BODY 3
9947020116603



CENTIGOR RIGHT BODY 1
9947020116604



CENTIGOR RIGHT BODY 2
9947020116605



CENTIGOR RIGHT BODY 3
9947020116606



CENTIGOR SPEAR 1
9947020116610



CENTIGOR SPEAR 2
9947020116611



CENTIGOR SPEAR 3
9947020116612

SPECIAL UNITS



Chaos Troll Blister (Random 1)
99060201153



CHAOS TROLL
LEFT ARM 1
(AXE)
9947020115307



CHAOS TROLL
LEFT ARM 2
(SWORD)
9947020115308



CHAOS TROLL
LEFT ARM 3
(CLUB)
9947020115309



CHAOS TROLL
RIGHT ARM 1
(GREAT AXE)
9947020115310



CHAOS TROLL
RIGHT ARM 2
(SWORD)
9947020115311



CHAOS TROLL
RIGHT ARM 3
(HAND AXE)
9947020115312



CHAOS TROLL
HEAD 1
9947020115301



CHAOS TROLL
HEAD 2
9947020115302



CHAOS TROLL
HEAD 3
9947020115303



CHAOS TROLL BODY 2
9947020115305



CHAOS TROLL BODY 3
9947020115306



CHAOS TROLL BODY 1
9947020115304





SPECIAL UNITS



Minotaur with Two Hand Weapons Blister (Random 1)
99060201043



**MINOTAUR WITH
ADDITIONAL
HAND WEAPON
RIGHT ARM 1**
9947020104307



**MINOTAUR WITH
ADDITIONAL
HAND WEAPON
LEFT ARM 1**
9947020104310



**MINOTAUR WITH
ADDITIONAL
HAND WEAPON
RIGHT ARM 2**
9947020104308



**MINOTAUR WITH
ADDITIONAL
HAND WEAPON
LEFT ARM 2**
9947020104311



**MINOTAUR WITH
ADDITIONAL HAND
WEAPON HEAD 1**
9947020104304



**MINOTAUR WITH
ADDITIONAL HAND
WEAPON HEAD 2**
9947020104305



**MINOTAUR WITH
ADDITIONAL HAND
WEAPON HEAD 3**
9947020104306



**MINOTAUR WITH
ADDITIONAL
HAND WEAPON
RIGHT ARM 3**
9947020104309



**MINOTAUR WITH
ADDITIONAL
HAND WEAPON
LEFT ARM 3**
9947020104312



**MINOTAUR WITH
ADDITIONAL HAND
WEAPON BODY 1**
9947020104301



**MINOTAUR WITH
ADDITIONAL HAND
WEAPON BODY 2**
9947020104302



**MINOTAUR WITH
ADDITIONAL HAND
WEAPON BODY 3**
9947020104303



SPECIAL UNITS



Minotaur with Great Weapon Blister (Random 1)
99060201042



MINOTAUR WITH GREAT WEAPON HEAD 2
9947020104207



MINOTAUR WITH GREAT WEAPON HEAD 3
9947020104208



MINOTAUR WITH GREAT WEAPON HEAD 1
9947020104205

MINOTAUR WITH GREAT WEAPON HEAD 1 JAW
9947020104206



MINOTAUR WITH TWO HANDED WEAPON LEG
9947020104204



MINOTAUR WITH GREAT WEAPON BODY 1
9947020104201



MINOTAUR WITH GREAT WEAPON BODY 2
9947020104202



MINOTAUR WITH GREAT WEAPON BODY 3
9947020104203



MINOTAUR WITH GREAT WEAPON BODY 1
9947020104209



MINOTAUR WITH GREAT WEAPON BODY 2
9947020104210



MINOTAUR WITH GREAT WEAPON ARMS 3
9947020104211



Minotaur Standard Bearer Blister (1)
99060201072



MINOTAUR STANDARD BEARER BANNER TOP
9947020107205



MINOTAUR STANDARD BEARER BODY
9947020107201



MINOTAUR STANDARD BEARER HEAD
9947020107202



MINOTAUR STANDARD BEARER WEAPON ARM
9947020107203



MINOTAUR STANDARD BEARER BANNER ARM
9947020107204



SPECIAL UNITS



CHAOS OGRE STANDARD
9947020115213



CHAOS OGRE MUSICIAN HORN
9947020115214



CHAOS OGRE CHAMPION MACE
9947020115212

Chaos Ogre Command Box (3)
99110201152

The Chaos Ogre Command boxed set includes all of the bitz shown below as well as the bitz shown to the left. The standard, horn, and champion mace are not available in the Chaos Ogre blister packs.



Chaos Ogre Blister (Random 1)
99060201152



CHAOS OGRE RIGHT ARM 1
9947020115207



CHAOS OGRE RIGHT ARM 2
9947020115208



CHAOS OGRE LEFT ARM 1
9947020115211



CHAOS OGRE LEFT ARM 2
9947020115210



CHAOS OGRE HEAD 1
9947020115201



CHAOS OGRE HEAD 2
9947020115202



CHAOS OGRE HEAD 3
9947020115203



CHAOS OGRE BODY 1
9947020115204



CHAOS OGRE BODY 2
9947020115205



CHAOS OGRE BODY 3
9947020115206



CHAOS OGRE RIGHT ARM 3
9947020115209

Chaos Ogres 1 and 2 can be assembled by mixing and matching the bodies and arms. Chaos Ogre 3 (with a great weapon) must use Chaos Ogre Body 3 and Chaos Ogre 3 Great Weapon.



**Chaos Dragon
Ogre Shaggoth Box (1)**
99110201147



SHAGGOTH AXE
9947020114707



SHAGGOTH HORNS
9947020114701



SHAGGOTH LEFT CLAW
9947020114702



**SHAGGOTH
RIGHT CLAW**
9947020114703



SHAGGOTH RIGHT LEG
9947020114705



SHAGGOTH BASE
9947020114706



SHAGGOTH BODY
9947020114704



RARE UNITS

BUILDING A HERDSTONE



Begin by gluing three equal-sized pieces of insulation foam together with white glue. Toothpicks pushed through the layers should hold the pieces together while the glue dries.



When the glue dries, shape the foam with a hobby knife. Cut away from yourself and change the direction of your cuts often to make an interesting shape.



Glue the foam to a foamcore base and fill the gaps with spackle. To simulate rocky texture, paint the piece with textured paint and then drybrush the herdstone with your colors of choice. Greys work well.



Adorn the base of your herdstone with trophies, skulls, weapons, and other bitz. You may want to paint these separately and then glue them on after you've painted the herdstone. For added detail, you could paint runes and hand prints along the bottom of the herdstone to represent the devotional markings Beastmen would make on their monolith.





RARE UNITS



Arm A fits Torsos A1 and A2 only, Arm B fits Torsos B1 and B2 only, Arm C fits Torsos C1 and C2 only, Leg 1 fits Body 1, Leg 2 fits Body 2.



DRAGON OGRE TORSO A1
9947020100504



DRAGON OGRE TORSO B1
9947020100506



DRAGON OGRE TORSO C1
9947020100514



DRAGON OGRE TORSO A2
9947020100512



DRAGON OGRE TORSO B2
9947020100513



DRAGON OGRE TORSO C2
9947020100508



DRAGON OGRE ARM A
9947020100505



DRAGON OGRE ARM B
9947020100507



DRAGON OGRE ARM C
9947020100509



DRAGON OGRE CLAW 1
9947020100503



DRAGON OGRE CLAW 2
9947020100511



Dragon OGRE Blister (Random 1)
99060201005



DRAGON OGRE BODY 1
9947020100501



DRAGON OGRE BODY 2
9947020100510

Leg 1 fits Body 1, Leg 2 fits Body 2.



DRAGON OGRE LEG 1
9947020100502



DRAGON OGRE LEG 2
9947020100515

SHOWCASE

ALTERNATE MODEL – CORE Tzaangor Champion

COMPONENTS FOR 1 COMPLETE MODEL

- 9947020100302 Beastman Champion 2
- 9947020114203 Tzeentch Lord Halberd
- 9947139903507 Chaos Magus Icons (x3)

COMPLEXITY RATING



BEASTMAN CHAMPION 2
9947020110302



**THIS CONVERSION
CONTAINS THE SPECIAL
OFFER BITZ SHOWN HERE**
*See the catalog introduction
for more information.*



**CHAOS
MAGUS ICONS**
9947139903507



*Left: Andrew Cromwell's Beastlord
took third place in the 2004
Baltimore Golden Demon.*

*Right: Mike Anderson's award-winning
Beast of Chaos from the UK Golden Demon.*



*Below: Jason Richards's
Thoggashi won first place
at the 2004 Canadian
Golden Demon
Painting Competition.*



*Left: Kyran Henry's
unique Beasts of Chaos
Giant from the Storm
of Chaos campaign.*

*Above: Eaoghan Cody took
home a trophy from the
2003 UK Golden Demon
Competition for his
Pestigor Standard Bearer.*

ALTERNATE MODEL – CORE Slaangor and Champion

COMPONENTS FOR 4 COMPLETE MODELS

- 9947020116801 Khazrak Head
- 99380201013 Beastman Regiment Sprue
- 99380201014 Chaos Warrior Sprue

COMPLEXITY RATING





COLORS OF WAR



KEY

■ Top Box(es): Basecoat Colors & Ink Washes

■ Bottom Box(es): Highlights

■ Mixed Colors



*Dwarf Flesh, Scorched Brown, Chaos Black
Bleached Bone, Snakebite Leather, Codex Grey*



*Chaos Black, Dwarf Flesh
Codex Grey, Dwarf Flesh & Skull White*



*Chaos Black, Chaos Black & Codex Grey
Shadow Grey, Codex Grey*



*Vermin Brown & Blazing Orange,
Snakebite Leather*



*Dwarf Flesh, Bestial Brown
Dwarf Flesh & Bleached Bone*



*Dark Angels Green & Rotting Flesh,
Snakebite Leather
Shadow Grey, Rotting Flesh*



*Scorched Brown,
Dark Flesh & Blood Red
Bestial Brown & Bubonic Brown*



*Vermin Brown, Scorched Brown
Dwarf Flesh, Bestial Brown*



*Vermin Brown, Vomit Brown
Scorched Brown, Bleached Bone*



*Shadow Grey & Bubonic Brown
Scab Red & Skull White*



*Scorched Brown, Bestial Brown
Codex Grey, Bleached Bone*



*Bestial Brown, Shadow Grey
Bleached Bone, Skull White*

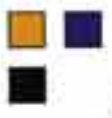

*Vomit Brown, Chaos Black Stripes
Regal Blue*



*Bestial Brown,
Vermin Brown*



*Scorched Brown, Scab Red
Bleached Bone, Brown Ink*

TACTICS

TIPS FOR WINNING WITH BEASTS OF CHAOS



- A. Use the *Ambush* rule to get your Beasts behind war machines, archers, Thunderers, or the like, and then go nuts behind enemy lines. If you have a really fast unit (such as Warhounds – shown in the *Hordes of Chaos* section – or Centigors), you can line up an *Ambushing* unit to sandwich an enemy between two of your regiments. Warhounds can also help negate enemy rank bonuses.
- B. Run a unit of Warhounds of Chaos next to a hard-hitting unit of Gors or Bestigors. When you get close to the enemy, single out a unit you do not want to engage with your heavy hitters. Use the Warhounds' movement to place them in front of the enemy, while the Gors or Bestigors aim themselves toward your target.
- C. A Bray-Shaman with the Staff of Darkoth, a Power Stone (to help cast the Wild Call), and the Lore of Shadows can march 10", cast Steed of Shadows to move another 20" toward the enemy, and then help an *Ambushing* unit get the charge right from the start with the Wild Call. This combination can be a little tricky to use but difficult to defeat.
- D. The Foe-render upgrade for Gor and Bestigor units is invaluable and gains you a bonus in both Attacks and Leadership for the unit. As Unit Champions go, few are more potent than the Foe-render. Thus, you can gleefully challenge away (as long as you're not facing a real monster of a character)! Don't forget to take advantage of this impressive Champion and challenge as often as possible, if you think you can win.



COUNTERTACTICS

TIPS FOR FIGHTING AGAINST BEASTS OF CHAOS

- A. Targeting the General is a great idea if there are *Ambushing* units around. If you can kill the General before he sounds the Brayhorn, all the units waiting around to *Ambush* your rear lines are considered destroyed!
- B. The Beasts of Chaos list is very versatile but, for the most part, contains lots of tough troops with little armor. Massed ranged fire (arrows or blackpowder weapons) can have a great impact on the Beasts' ability to hurt you, as will war machines. Nevertheless, perhaps the best tactic you can use against the Beastmen is to avoid fighting on their terms – shoot from range, attack the flanks and rear whenever you can, and remember that their Leadership isn't all that high either. Even light missile fire from bows and longbows works well against herds with Ungors in them.
- C. Judicious use of Dispel Scrolls can counter the Bray-Shaman's spellcasting. You can also position skirmishers to try and anticipate *Ambushing* units.
- D. In combat against Beast units with a Foe-render, be sure to allocate an attack on the charge to try and eliminate the Unit Champion. Destroying this model as soon as possible is good for enemies of the Beastmen. If the Foe-render falls, the unit's Leadership and its number of attacks will be reduced.

BRETONNIANS

Baron Pierre d'Artaud's heart swelled with pride as the various Knights of the Realm gathered under his war banner. These noble and honorable warriors were duty-bound to defend this land. They had heeded his warning of the invasion and had mustered from the surrounding villages and keeps. If the invading Orcs were to enter this realm, they would do so here where the hills opened up into fertile farmland. And here is where the Baron's forces would meet them.

The morning breeze rippled multicolored heraldry, and the bright pennants danced in the wind. Two dozen Knights were forming up into three equal-sized units. On the flank, the young Knights Errant paced, impatient for the day's glory. It was with less pride that the Baron's eyes fell upon the Men-at-Arms, although they still displayed the honor of their masters in their house livery and stout shields. Still worse, gathering at the back, the Peasant Bowmen shuffled into place in the battle line, and the Baron thought their demeanor and carriage rather disheartening. The more he looked at the Bowmen, the more the Baron felt quite sure that some of these same scruffy men were the ones who had been pilfering game from his lands.

However, this disdain soon passed. Their trespasses were forgiven, for they too had answered the summons to battle. No one could invade Bretonnia and live to tell the tale. Today was not a day for recriminations, but for glory.

Bretonnia is a human realm second only in size to her eastern neighbor, the Empire. Bretonnia is most famous for the quality and nobility of her Knights, and indeed, these powerful warriors form the basis of most Bretonnian armies. While the manners, grace, and gallantry of the Knights are legendary, so too are the ignorance and general dirtiness of the common peasants and simple farmers.

Fighting Style

Not surprisingly, a Bretonnian army is almost always organized around its units of Knights. These powerful units are fast and hard-hitting and have an armor save that is the envy of almost every other

Above Right: Richard Henderson's Bretonnian Knight from the 2004 French Golden Demon Painting Competition.

Below Left: Zach Lanier's Grail Knight won second place at the 2004 Canadian Games Day Golden Demon Painting Competition.

army in the game. A Bretonnian army wants to send as many Knights galloping toward the foes as it can. Some enemies may have a few war machines, magic items, or elite troops that can regularly dent the heavy armor of the Knights, but few foes can field enough of these Knight-slayers to account for more than a unit or two. So take more than a few units! Grail Knights are the hardest hitting. Pegasus Knights are the most mobile, and the Knights of the Realm and Knights Errant cost the fewest points. Protected by the Lady of the Lake and their sacred vows, Bretonnian Knights aim to ride over anything that dares to stand in front of them.

While the majority of the strike force is invariably made of Knights of some form, the Peasant Bowmen and Men-at-Arms also serve a useful (if secondary) purpose. Guarding flanks, peppering the enemy with missile fire, and the like are the roles of these more lowly warriors. Other more specialized units, like the Mounted Yeomen or the Battle Pilgrims with their Grail Reliquae, can perform admirably on the battlefield as well. And don't leave out the devastating peasant-crewed Field Trebuchet, which can give Bretonnia's foes something besides Knights to worry about. But remember, these non-Knight units can be useful, but they'll never replace a lance charge by a beautifully painted unit of Knights!

Collecting a Bretonnian Army

Core units are always the way to start collecting an army, and with Bretonnians, that leaves you with quite a few choices. Knights are essential to any up-and-coming Bretonnian Duke, and most players will want a few of these valorous units at the minimum. There are many levels of Knights, each with its own advantages. Knights Errant are the unproven youth seeking to earn their honor in battle and are slightly lower in points cost but still a valuable unit. Knights of the Realm are more proven and have a higher Weapon Skill and Leadership value than the more Impetuous Knights Errant. As Knights Errant and Knights of the Realm are both Core choices, it is possible to field lots of these potent units.

After filling up a few Core choices, many choices remain. Questing Knights are harder-hitting still, and at the top of the chart are the mighty Grail Knights, whose thunderous charge can break any enemy unit. One unit of Pegasus Knights may also be selected, and this unit adds the mobility of flying to the awesome offensive powers of the Knights! Leave room (but just a little) for some supporting cast of Men-at-Arms and Peasant Bowmen. They are sometimes effective, and they'll make your Knights look even better!





Bretonnian Battalion Box 99120203005

- 8 Bretonnian Knights
- 16 Bowmen
- 16 Men-at-Arms
- 3 Pegasus Knights



GETTING STARTED



This 80-page rulebook contains painting and modeling guides, background, and the full rules for fielding an army of Bretonnian Knights and Commoners.

**Warhammer
Armies: Bretonnia**
60030203001



Bretonnian Duke Blister (Random 1)
99060203087



LORDS & HEROES

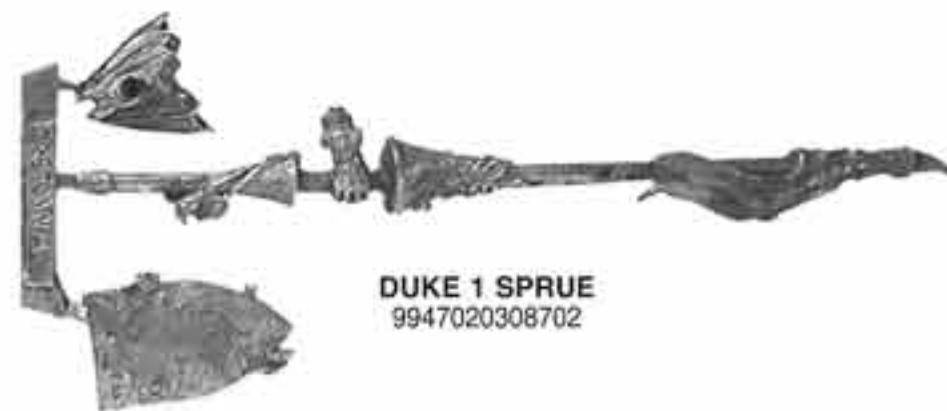

DUKE 1 SPRUE
9947020308702

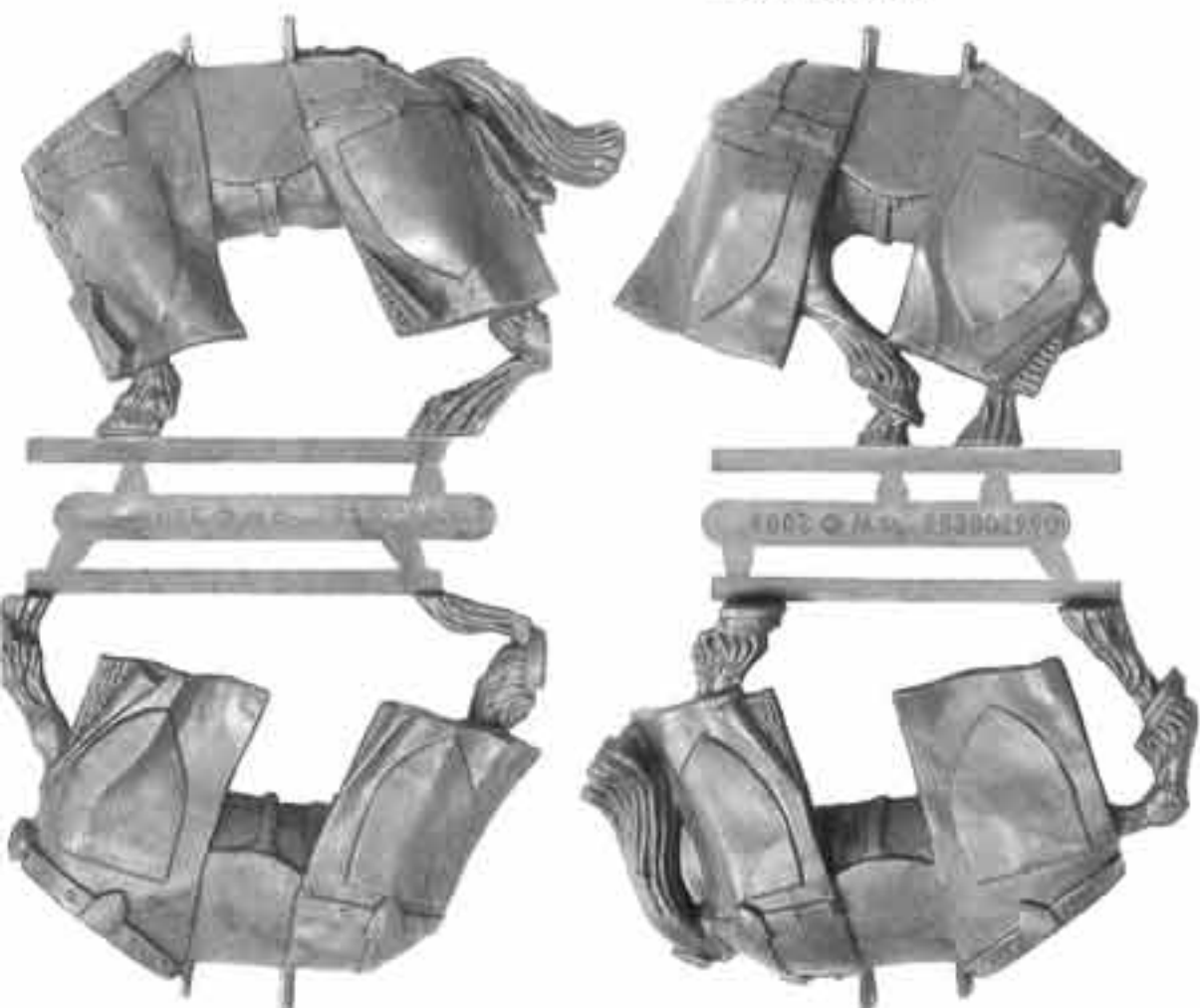

BRETONNIAN HORSE BODY SPRUE (RANDOM 1)
99380299006



DUKE 2 PACK
9947020308706



DUKE 1 PACK
9947020308703



DUKE 2 SPRUE
9947020308705



DUKE 2 BODY
9947020308704



DUKE 1 BODY
9947020308701



BRETONNIAN HORSE HEAD SPRUE (RANDOM 1)
99380299007



LORDS & HEROES



DAMSEL ON FOOT
9947020308902

MOUNTED DAMSEL

Bretonnian Damsels Blister (2)
99060203089



MEDIEVAL HORSE HEAD SPRUE
99389999013



MOUNTED DAMSEL
9947020308901



MEDIEVAL HORSE BODY SPRUE
99389999003



Bretonnian Battle Standard Bearer Blister (1)
99060203092

The Bretonnian Battle Standard Bearer includes the Bretonnian Horse Body and Head Sprues (99380299006-7) shown on the previous page.



BATTLE STANDARD BEARER LEGS
9947020309205



BATTLE STANDARD BEARER STANDARD
9947020309203



BATTLE STANDARD BEARER BODY
9947020309201



BATTLE STANDARD BEARER ARM
9947020309202

LORDS & HEROES



Green Knight Box (1)
99110203086

The Green Knight is the champion of the Lady of the Lake and protector of the sacred sites of Bretonnia. As well as materializing to test Questing Knights in their faith, the Green Knight will appear when these sacred places are defiled by those with evil-hearted intent.



GREEN KNIGHT HORSE HEAD
9947020302807



GREEN KNIGHT SHIELD
9947020302803



GREEN KNIGHT PENNANT POLES
9947020302802



GREEN KNIGHT HORSE RIGHT SIDE
9947020302805



GREEN KNIGHT LEGS
9947020302804



GREEN KNIGHT BODY
9947020302801



GREEN KNIGHT HORSE LEFT SIDE
9947020302806



Fey Enchantress Box (1)
99110203097



**FEY ENCHANTRESS BODY/
UNICORN LEFT BODY**
9947020309701



FEY ENCHANTRESS BASE
9947020309703



**FEY ENCHANTRESS
UNICORN RIGHT BODY**
9947020309702



LORDS & HEROES



Louen Leoncoeur on Hippogriff Box (1)
99110203085

Louen Leoncoeur on Hippogriff includes the Bretonnian Pegasus Wings (99380299008) shown with the Pegasus Knights in Special Units.



LEONCOEUR LANCE SPRUE
9947020308505



LEONCOEUR ARM SPRUE
9947020308503



LEONCOEUR HIPPOGRIFF LEFT CLAW
9947020308507



LEONCOEUR BODY
9947020308501

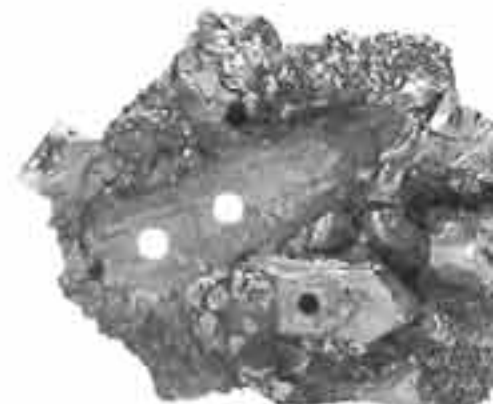

LEONCOEUR BASE
9947020308510



LEONCOEUR HIPPOGRIFF RIGHT SIDE
9947020308509



LEONCOEUR CLOAK
9947020308504



LEONCOEUR HIPPOGRIFF HEAD
9947020308506



LEONCOEUR HEAD SPRUE
9947020308502



LEONCOEUR HIPPOGRIFF LEFT SIDE
9947020308508



CORE UNITS



The Knights of Bretonnia boxed set includes the Bretonnian Horse Body and Head Sprues (99380299006-7) shown with the Bretonnian Dukes.

Knights of Bretonnia Box (8)
99120203003

BRETONNIAN KNIGHTS TRANSFER SHEET

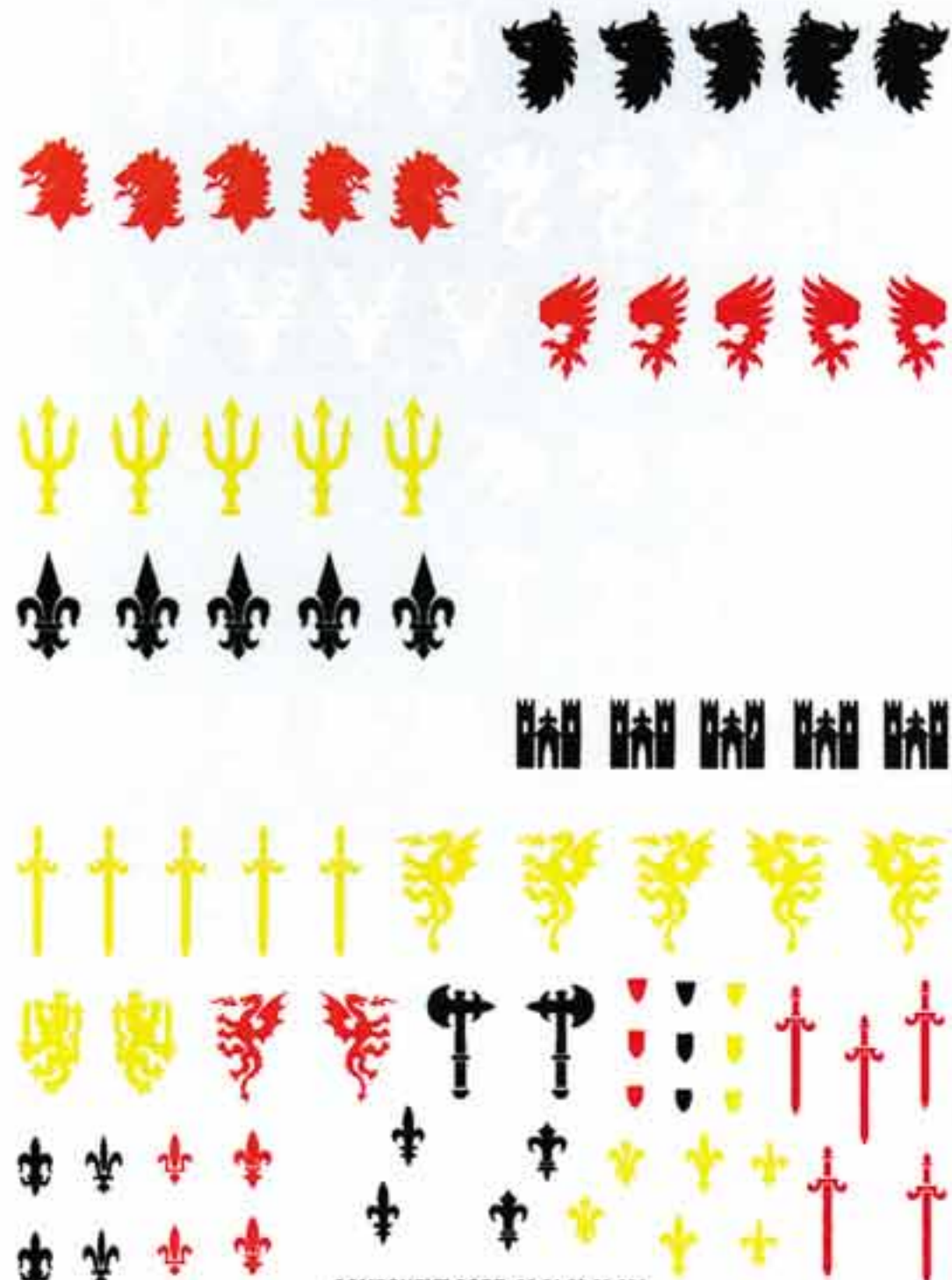

COMPONENT CODE: 99 51 02 03 001

BRETONNIAN DECAL SHEET (SHOWN 50% ACTUAL SIZE)
99510203001

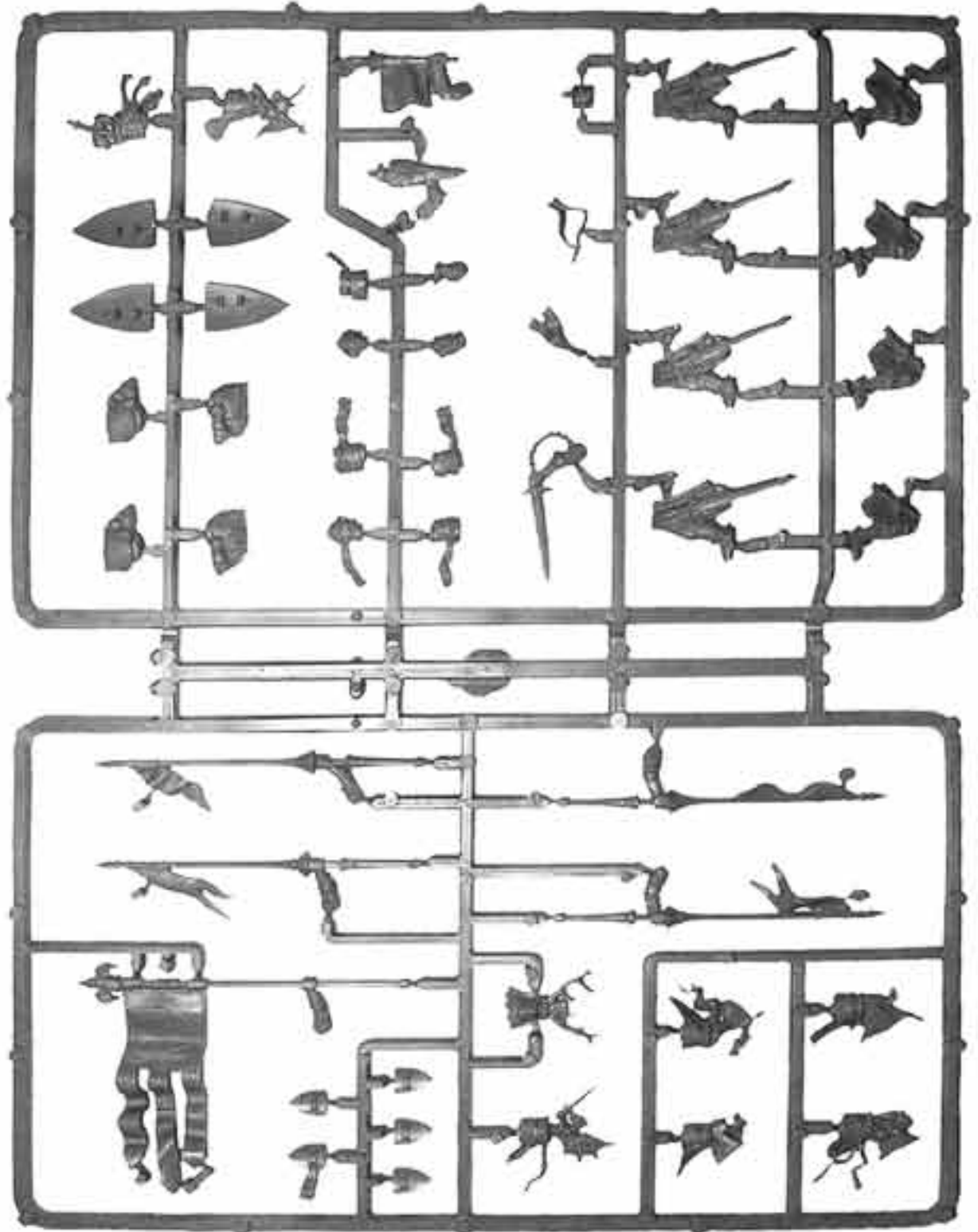

BRETONNIAN KNIGHTS SPRUE (SHOWN 50% ACTUAL SIZE)
99380203005



COMPANIONS



Bretonnian Men-at-Arms Box (16)
99120203004

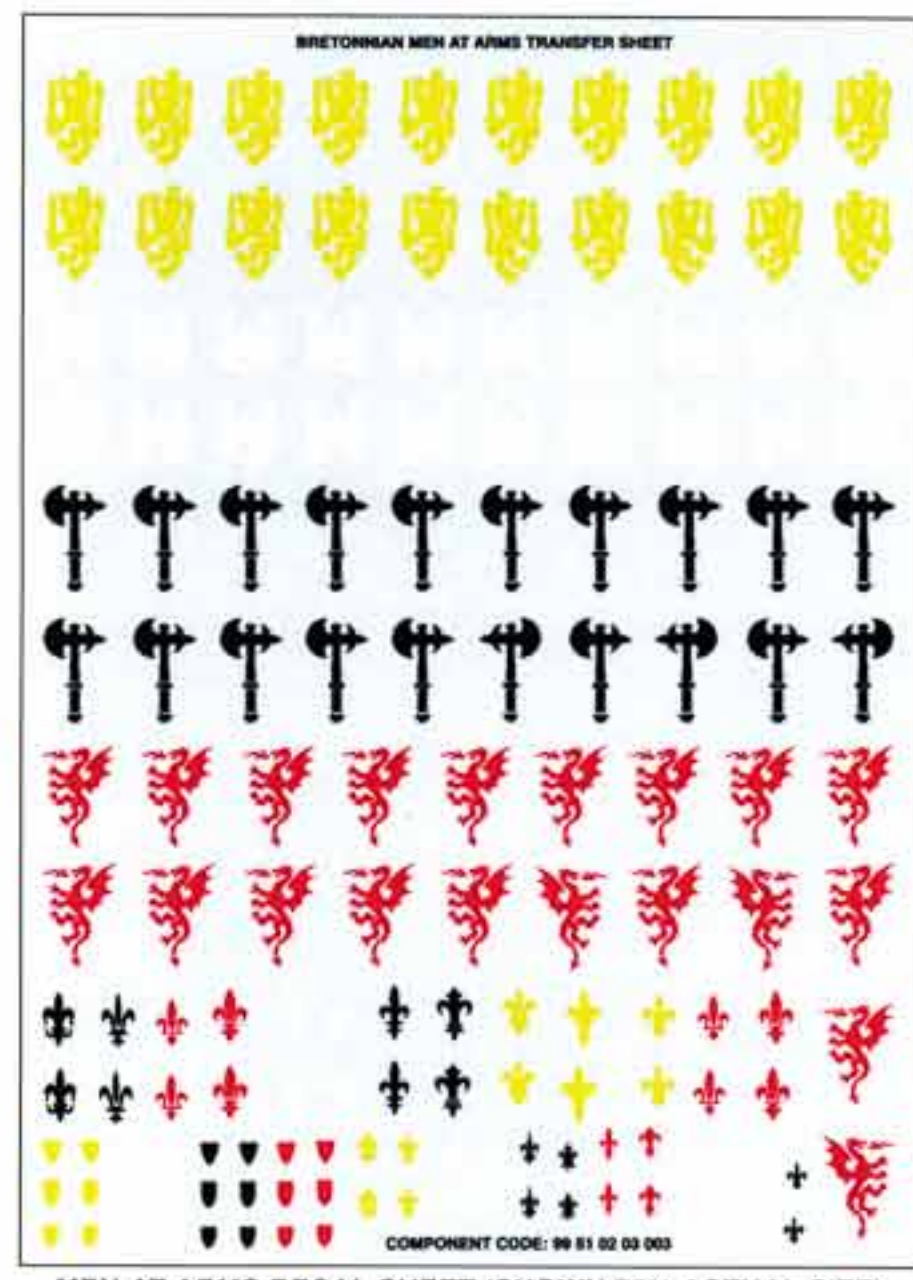

MEN-AT-ARMS DECAL SHEET (SHOWN 75% ACTUAL SIZE)
99510203003

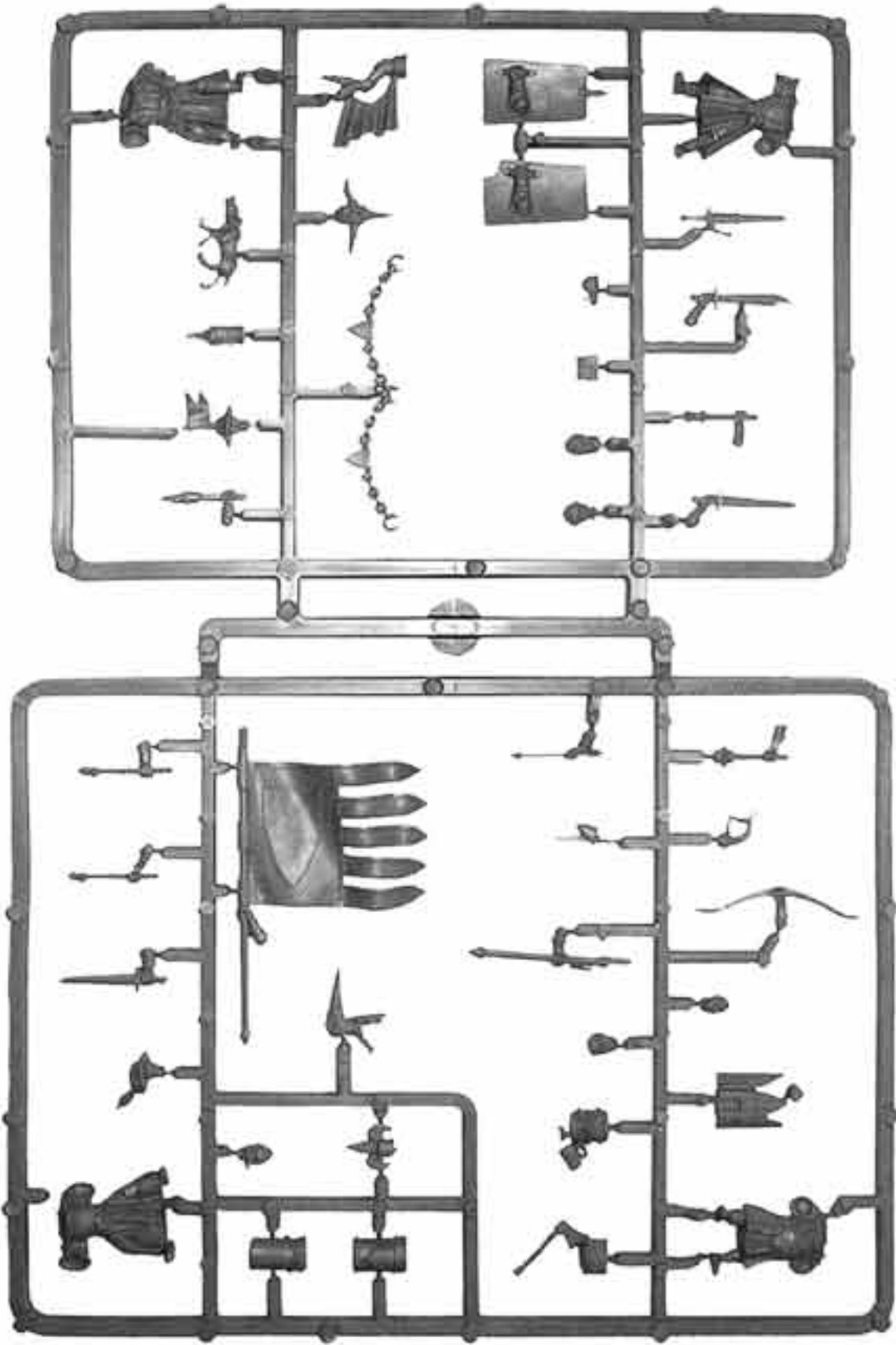

BRETONNIAN FOOT COMMAND SPRUE (SHOWN 60% ACTUAL SIZE)
99380203004

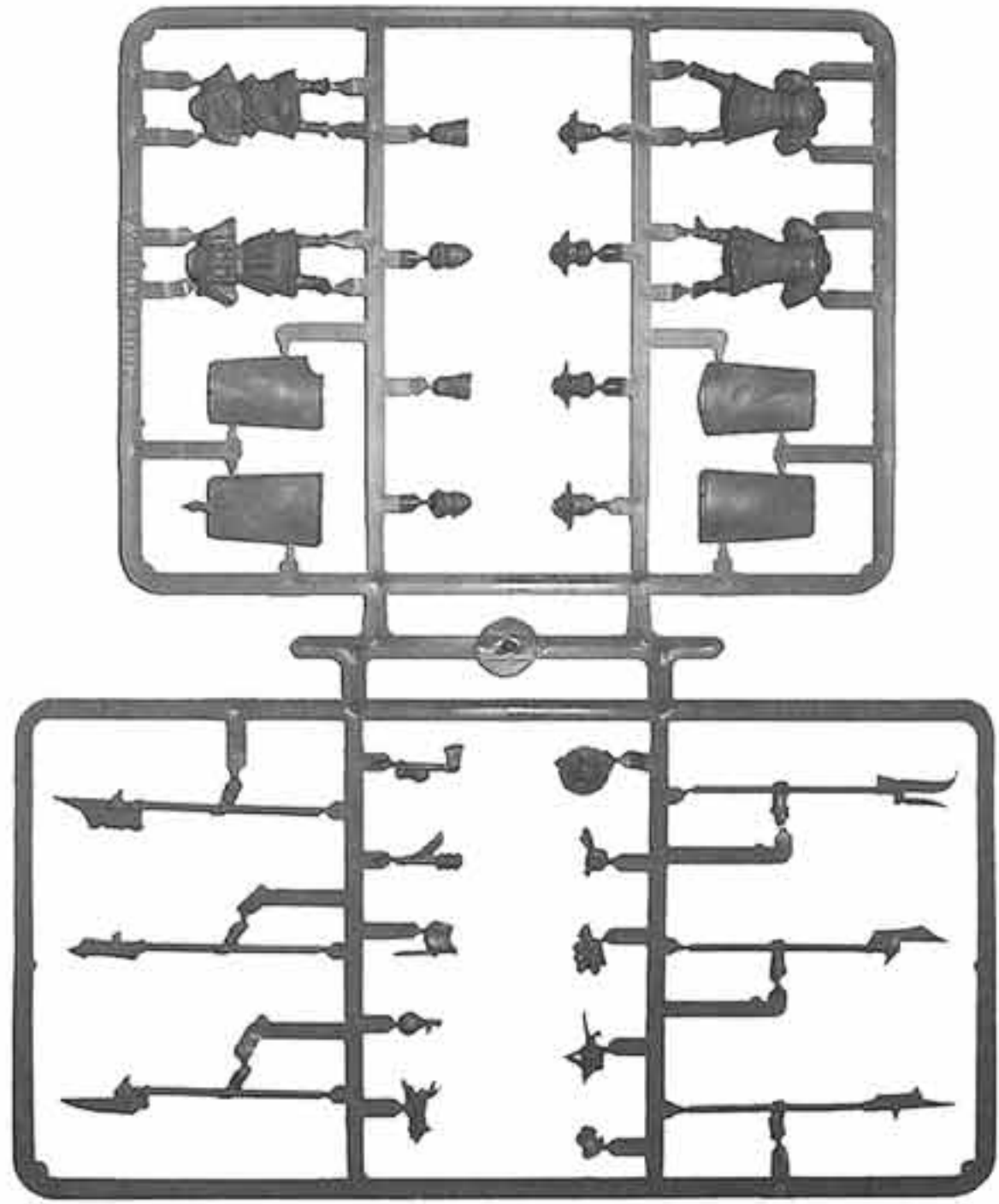

BRETONNIAN MEN-AT-ARMS SPRUE (SHOWN 60% ACTUAL SIZE)
99380203002

CORE UNITS



The Bretonnian Bowmen include the Bretonnian Men-at-Arms Decal Sheet (99510203003) and the Bretonnian Foot Command Sprue (99380203004) shown on the opposite page.

Bretonnian Bowman Box (16)
99120203006

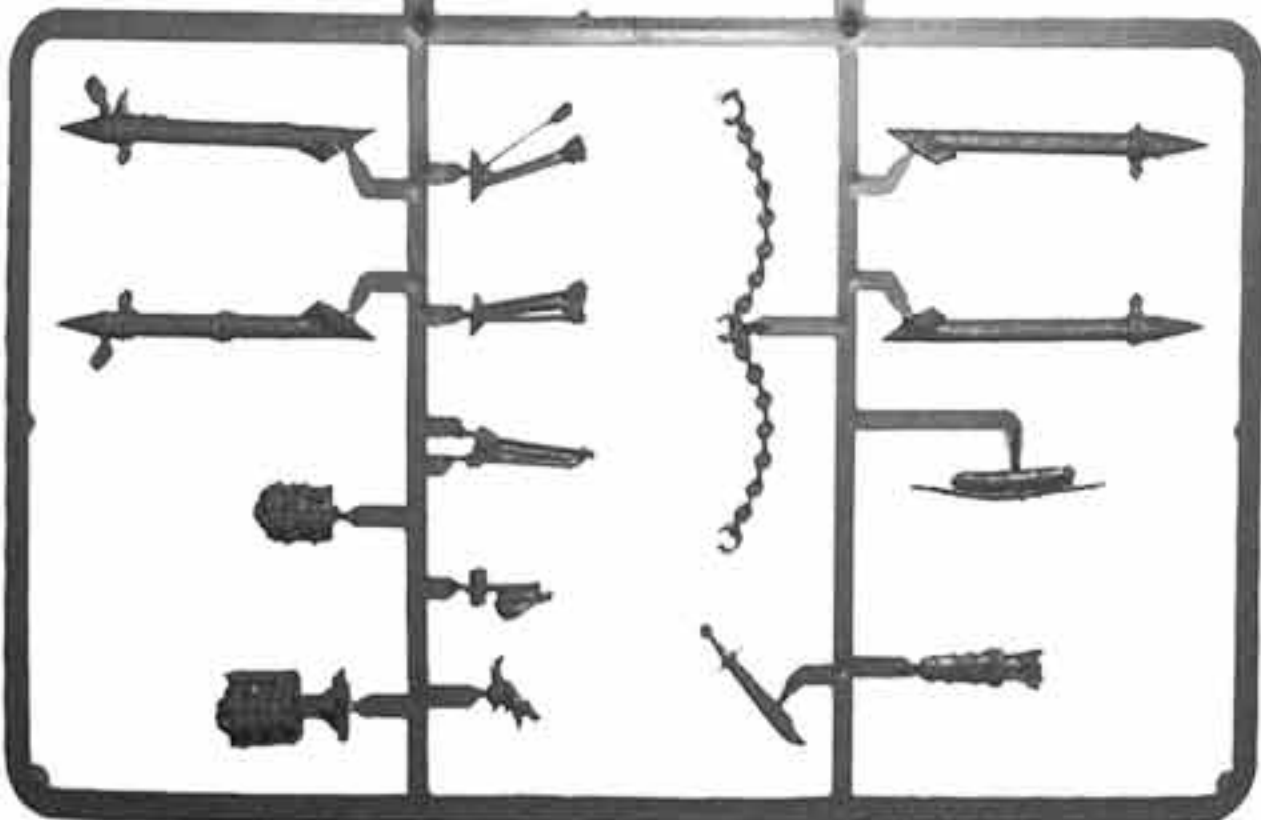
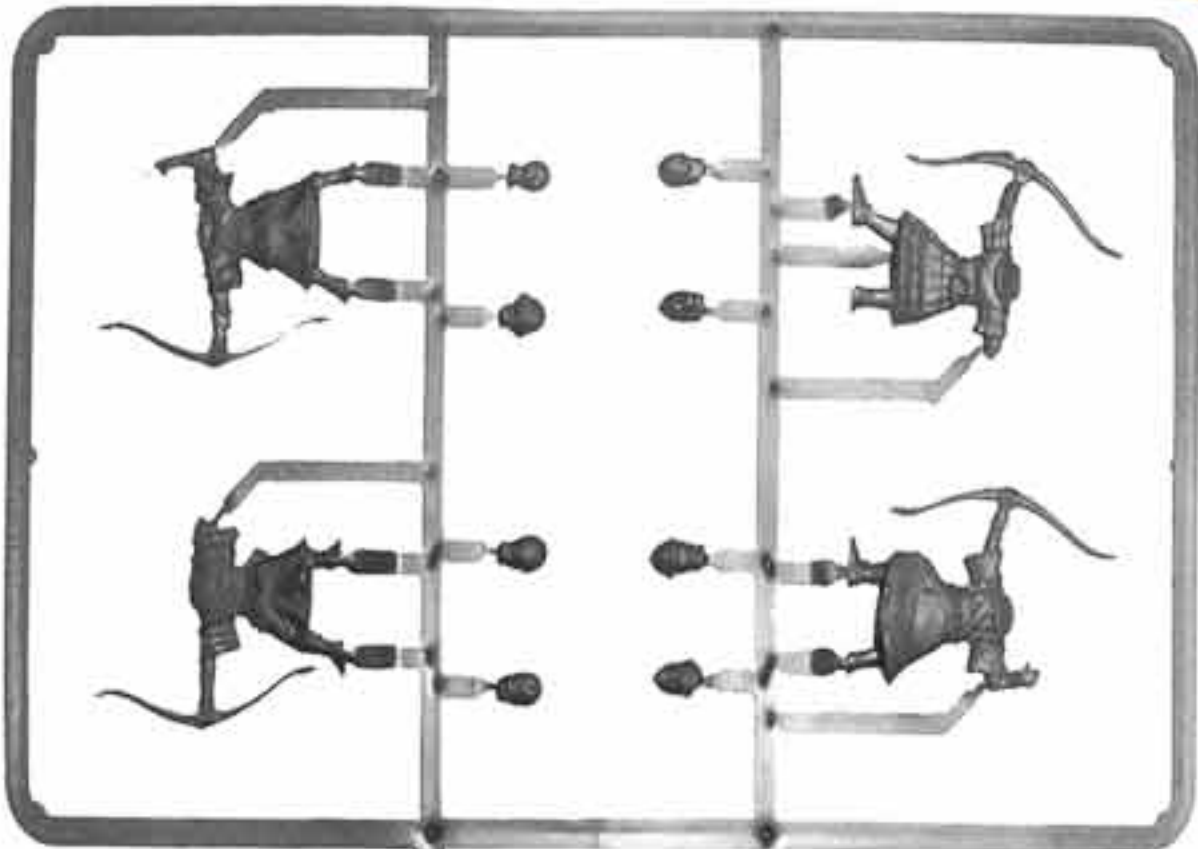

BRETONNIAN BOWMEN SPRUE (SHOWN 60% ACTUAL SIZE)
99380203003

PAINTING LEATHER ARMOR

While Bretonnian Lords and Knights may have very ornate and well-crafted suits of armor, Bretonnian Peasants have rather poor-quality protection. They may have armor of canvas, heavy cloth, or leather stitched or quilted in a pattern. Since the Peasants' masters usually provide their underlings with arms and armor, you could choose to paint your Peasants' armor in the Lord's colors. Otherwise, here are two ways to paint brown leather armor.



STEP 1

Begin with a Chaos Black undercoat. (Left) Paint a basecoat of Dark Flesh on the jacket. (Right) Paint a basecoat of Vermin Brown. Basecoat both yokes with Scorched Brown.



STEP 2

(Left) Highlight with a 50/50 mix of Blood Red and Dark Flesh. (Right) Wash the armor with Black Ink. Highlight the yokes with a mix of Bleached Bone and Scorched Brown.



STEP 3

(Left) Add more Blood Red to the mix for the final highlight. (Right) Paint Vermin Brown on the top edges of the diamond quilting with a Fine Detail Brush. Add more Bleached Bone to the Scorched Brown mix for the last highlights on the yoke.



SPECIAL UNITS



The Questing Knight Regiment boxed set includes the three command models and Questing Knights 3 and 6 (shown on this page) as well as the Bretonnian Decal Sheet (99510203001) shown with the Bretonnian Knights. The Questing Knight blister pack includes a random Knight (not command). Both the boxed set and blister pack include the Bretonnian Horse and Head sprues (99380299006-7) shown with the Bretonnian Dukes.



QUESTING KNIGHT
STANDARD
BEARER SHIELD
9947020309023

QUESTING KNIGHT
STANDARD BEARER BODY
9947020309021



QUESTING KNIGHT
STANDARD
9947020309022



QUESTING KNIGHT
MUSICIAN BODY
9947020309019



QUESTING KNIGHT
MUSICIAN PACK
9947020309020



QUESTING KNIGHT
LOOKOUT
9947020309024



QUESTING KNIGHT
CHAMPION BODY
9947020309017



QUESTING KNIGHT
CHAMPION PACK
9947020309018



Questing Knight Regiment Box (5)
99110203090

Questing Knight Blister (Random 1)
99060203090



QUESTING KNIGHT
BODY 3
9947020309005



QUESTING KNIGHT
PACK 3
9947020309006



QUESTING KNIGHT
BODY 6
9947020309015



QUESTING KNIGHT
PACK 6
9947020309016

The Questing Knight bits shown here are included in the Questing Knight Blister (99060203090) on the opposite page.



QUESTING KNIGHT BODY 1
9947020309001



QUESTING KNIGHT BODY 2
9947020309003



QUESTING KNIGHT BODY 4
9947020309007



QUESTING KNIGHT BODY 5
9947020309011



QUESTING KNIGHT ARM 1
9947020309002



QUESTING KNIGHT ARM 4
9947020309008



QUESTING KNIGHT SWORD 5
9947020309012



QUESTING KNIGHT PACK 2
9947020309004



QUESTING KNIGHT PACK 5
9947020309014



QUESTING KNIGHT PACK 4
9947020309010



QUESTING KNIGHT SHIELD 4
9947020309009



QUESTING KNIGHT SHIELD 5
9947020309013



SPECIAL UNITS

PAINTING SHIELDS

By painting a common motif on your army's shields, you can tie your Bretonnian models together. Almost every model in the army can have a shield, and those who do not will often have some sort of icon or trinket that resembles a small shield. As such, you can use a common shield motif to bring your army together. Here are some tips for painting Bretonnian shields.

EXAMPLE 1



Step 1. Prime the shield with Skull White spray primer and paint one half of the shield Golden Yellow and the other half Snot Green. Paint the Golden Yellow side first. If you make a mistake, Snot Green will cover over the Golden Yellow easier than Golden Yellow will cover Snot Green.



Step 2. Highlight the edge of the green side with a 50/50 mix of Snot Green and Scorpion Green. Highlight the edge of the yellow side with a 50/50 mix of Golden Yellow and Skull White.



Step 3. Apply final highlights of Scorpion Green over the green and Skull White over the yellow.



Step 4. Finally, paint the metal rim of the shield Chaos Black and then Chainmail. Leave a small line of Chaos Black showing to provide some definition between the face and the rim of the shield. Finally, add heraldic devices.

EXAMPLE 2



Step 1. Here's another way to paint a shield with different colors. Start with a shield primed with Skull White. Paint the top half with Blood Red and the bottom half with Enchanted Blue.



Step 2. Highlight the red area with Blazing Orange and the blue area with a 75/25 mix of Enchanted Blue and Skull White.



Step 3. Add final highlights of Fiery Orange for the red half of the shield and a 50/50 mix of Enchanted Blue and Skull White to the blue half of the shield.



Step 4. Paint the rim of the shield Chaos Black and then Chainmail. Leave a small line of Chaos Black showing to provide some definition between the face and the rim of the shield. Next paint the heraldic device. For a more complex or larger device, draw your design on a piece of paper first or even on the shield itself to get an idea of how you want to design and then paint the symbol.





SPECIAL UNITS

The Grail Reliquae boxed set includes Battle Pilgrims 1, 2, 4, 5, 6, and 9 shown on the opposite page.



GRAIL RELIQUAE DOG
9947020309409



GRAIL RELIQUAE LANCE
9947020309402



GRAIL RELIQUAE SHIELD
9947020309403

Bretonnian Grail Reliquae Box (1)
99110203094



GRAIL RELIQUAE CARRIER 1
9947020309404



GRAIL RELIQUAE CARRIER 2
9947020309405



GRAIL RELIQUAE CARRIER 3
9947020309406



GRAIL RELIQUAE CARRIER 4
9947020309407



GRAIL RELIQUAE BAR
9947020309408



GRAIL RELIQUAE BASE
9947020309410



GRAIL RELIQUAE DEAD KNIGHT
9947020309401



SPECIAL UNITS



Bretonnian Grail Pilgrim Blister (Random 3)
99060203095



BATTLE PILGRIM 6
9947020309506



BATTLE PILGRIM 3
9947020309503



BATTLE PILGRIM 9
9947020309509



BATTLE PILGRIM 1
9947020309501



BATTLE PILGRIM 7
9947020309507



BATTLE PILGRIM 4
9947020309504



BATTLE PILGRIM 5
9947020309505



BATTLE PILGRIM 2
9947020309502



BATTLE PILGRIM 8
9947020309508



BATTLE PILGRIM SHIELDS
9947020309510

PAINTING A PEGASUS

Pegasus Knights are powerful elite troops that appear in many Bretonnian armies. However, because of the complexity of the model, some painters may be intimidated by the Pegasus itself, which requires a greater level of attention than a Knight's horse. Below, we detail an easy way to paint the Pegasus model.

STEP 1

After priming the model white, paint the skin, hair, and feathers Codex Grey. Don't attach the Knight to the Pegasus until both have been painted.



STEP 2

Highlight with Fortress Grey by painting the raised areas of the Pegasus' skin. Use Fortress Grey to drybrush the wings, tail, mane, and hair above the hooves.



STEP 3

Blend a 50/50 mix of Fortress Grey and Skull White and highlight the model in the same way: paint the skin and drybrush the textured areas.



STEP 4

Use Skull White for the last highlights. Paint the metal and cloth armor the same way you would on a normal steed, though Pegasus Knights will tend to have more elaborate and ornate heraldry.



BRETONNIAN PEGASUS WINGS
99380299008

Bretonnian Pegasus
Knights Box (3)
99120203007

The Pegasus Knights boxed set includes the Decal Sheet (99510203001) shown with the Bretonnian Knights.

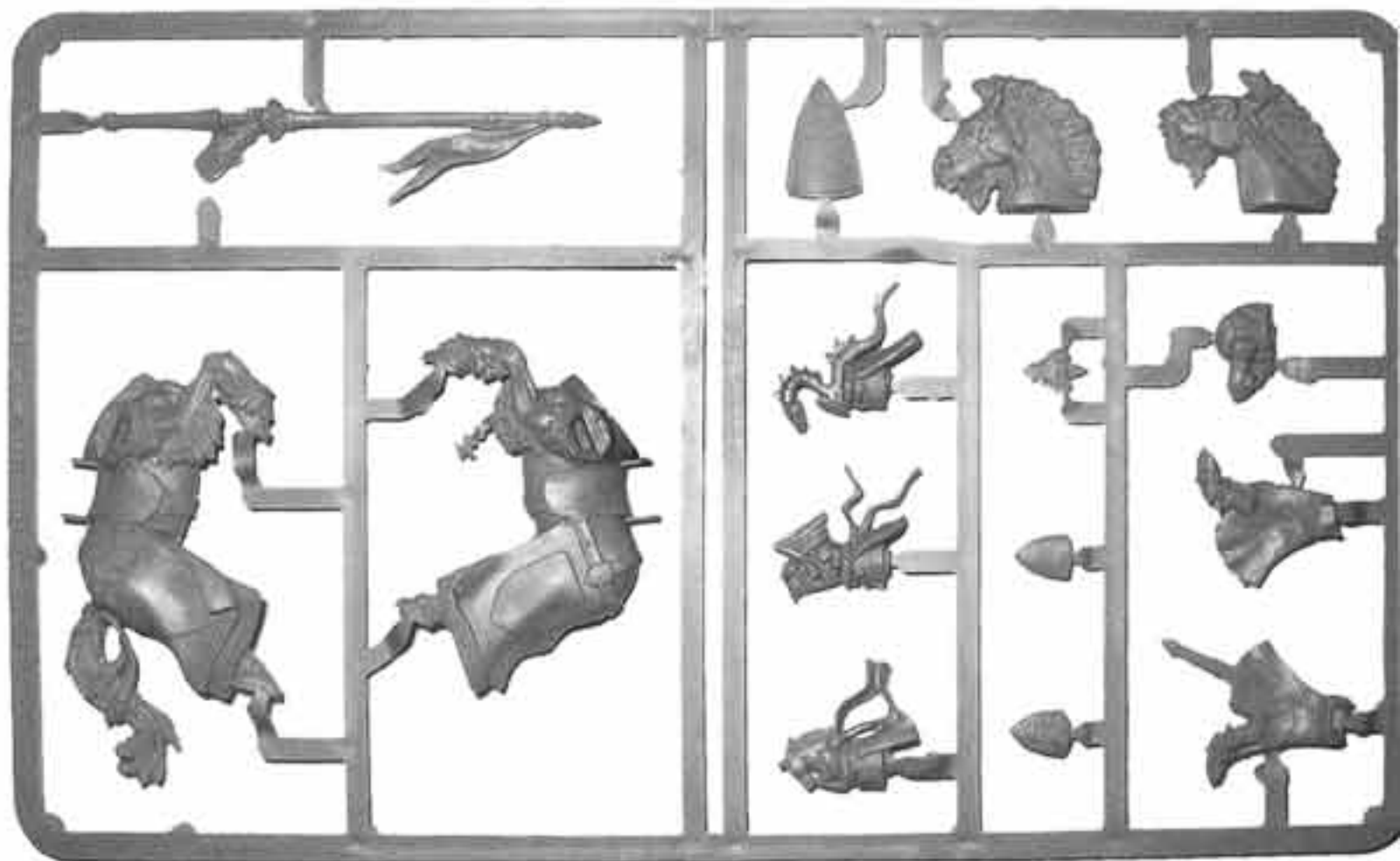

BRETONNIAN PEGASUS KNIGHT SPRUE (SHOWN 65% ACTUAL SIZE)
99380203006

SPECIAL UNITS

Mounted Yeomen include the Medieval Horse Body (99389999003) and Medieval Horse Head Sprue (99389999013) shown with the Bretonnian Damsel.



Mounted Yeomen Blister (Random 1)
99060203033



FIGHTER SHIELD SPRUE
99369999003



MOUNTED SQUIRE SPEAR ARM 1
9947020303316



MOUNTED SQUIRE SPEAR ARM 2
9947020303317



MOUNTED SQUIRE BODY 1
9947020303301



MOUNTED SQUIRE BODY 2
9947020303302



MOUNTED SQUIRE BODY 3
9947020303303



These alternate bits for the Mounted Yeomen are available only via Special Offer.



MOUNTED SQUIRE BODY 4
9947020303304



MOUNTED SQUIRE BODY 5
9947020303305



MOUNTED SQUIRE BODY 6
9947020303306



MOUNTED SQUIRE BODY 7
9947020303307



MOUNTED SQUIRE BODY 8
9947020303308



MOUNTED SQUIRE BODY 9
9947020303309



MOUNTED SQUIRE BODY 11
9947020303311



MOUNTED SQUIRE BODY 10
9947020303310



MOUNTED SQUIRE BODY 14
9947020303314



MOUNTED SQUIRE BODY 12
9947020303312



MOUNTED SQUIRE BODY 13
9947020303313



MOUNTED SQUIRE BODY 15
9947020303315



RARE UNITS

The Grail Knights boxed set includes the Bretonnian Horse Body and Head Sprues (99380299006-7) shown with the Bretonnian Dukes.



Grail Knight Regiment Box (5)
99110203093



GRAIL KNIGHT STANDARD
9947020309327



GRAIL KNIGHT CHAMPION ARM
9947020309325



GRAIL KNIGHT MUSICIAN BODY
9947020309328



GRAIL KNIGHT BODY 1
9947020309301



GRAIL KNIGHT BODY 2
9947020309302



GRAIL KNIGHT LANCE 1
9947020309307



GRAIL KNIGHT LANCE 2
9947020309308



GRAIL KNIGHT BODY 3
9947020309303



GRAIL KNIGHT BODY 4
9947020309304



GRAIL KNIGHT BODY 5
9947020309305



GRAIL KNIGHT LANCE 3
9947020309309



GRAIL KNIGHT LANCE 4
9947020309310



GRAIL KNIGHT SHIELD 1
9947020309313



GRAIL KNIGHT SHIELD 2
9947020309314



GRAIL KNIGHT SHIELD 3
9947020309315



GRAIL KNIGHT SHIELD 4
9947020309316



GRAIL KNIGHT SHIELD 5
9947020309317



GRAIL KNIGHT LANCE 5
9947020309311

All miniatures are supplied unpainted. Models, bits, and sprues are all shown at full size unless otherwise noted. Contents may vary slightly from those shown.



RARE UNITS



GRAIL KNIGHT CHAMPION LEGS
9947020309326



GRAIL KNIGHT LEGS 1
9947020309319



GRAIL KNIGHT LEGS 2
9947020309320



GRAIL KNIGHT LEGS 3
9947020309321



GRAIL KNIGHT LEGS 4
9947020309322



GRAIL KNIGHT LEGS 5
9947020309323



These alternate bits for the Grail Knights are available only via Special Offer.



GRAIL KNIGHT SHIELD 6
9947020309318



GRAIL KNIGHT LEGS 6
9947020309324



GRAIL KNIGHT BODY 6
9947020309306



GRAIL KNIGHT LANCE 6
9947020309312

BRETONNIAN GRAIL KNIGHTS TRANSFER SHEET



COMPONENT CODE: 99 51 02 03 002

BRETONNIAN GRAIL KNIGHT DECAL SHEET (SHOWN 50% ACTUAL SIZE)
99510203002

BRETONNIAN HERALDRY

Probably the most visually striking element of a Bretonnian army is its colorful and diverse heraldry. Shown below is an example of one player's nontraditional take on the heraldry of a Knightly hero and how servants of the Knight would display the hero's heraldry.



This hero represents a Hermit Knight, a solitary guardian of a grail chapel whose charge is, appropriately, a key. The field colors of green and blue represent the forest of the Knight's realm and the lake by which the shrine resides, respectively. The checkerboard pattern was added to represent the unstable mental health of the Knight, which is undoubtedly the result of years of seclusion. The Knight's shield has been decorated further with devotional parchments and a resting messenger bird, which is present in case the Knight should have to send a message to civilization.



The Knight above and the Man-at-Arms to the right serve the Hermit Knight and thus display a simplified version of his heraldry. Using similar heraldry on your models will help unify your army.

RARE UNITS



Bretonnian Trebuchet Box (1)
99110203091



TREBUCHET WHEELBARROW
9947020309106



TREBUCHET RUBBLE
9947020309107



TREBUCHET COUNTERWEIGHT
9947020309108



TREBUCHET CREW 1
9947020309101



TREBUCHET CREW 2
9947020309102



TREBUCHET CREW 3
9947020309103



TREBUCHET CREW 4
9947020309104



TREBUCHET CREW 5
9947020309105



TREBUCHET ARM
9947020309112

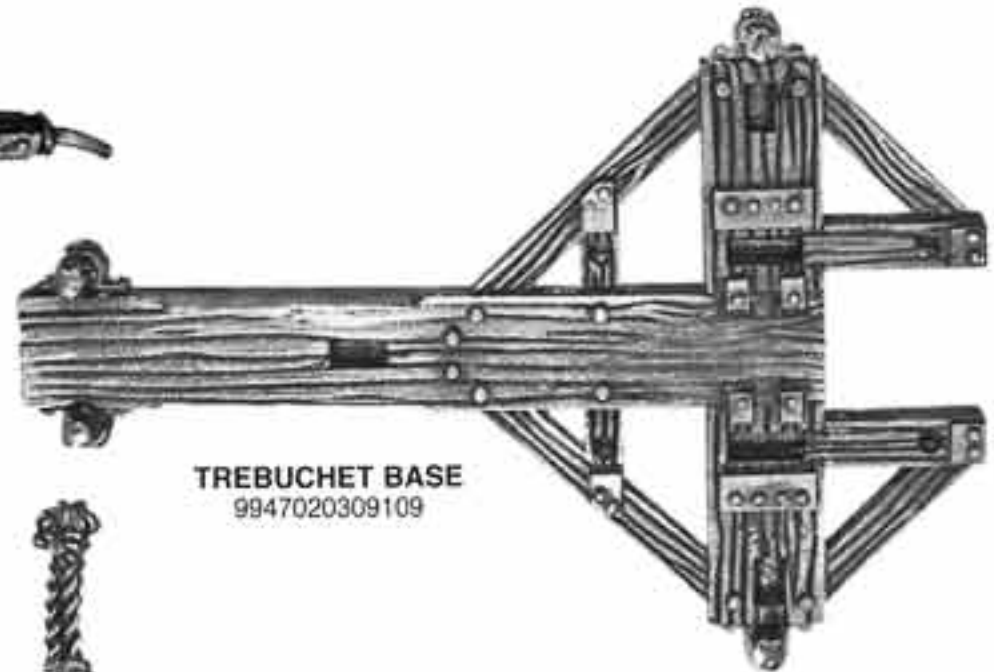

TREBUCHET BASE
9947020309109

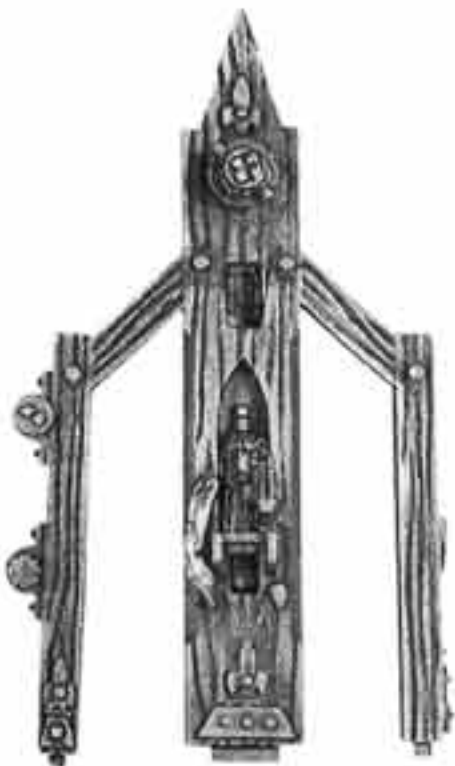

TREBUCHET SIDE 1
9947020309110

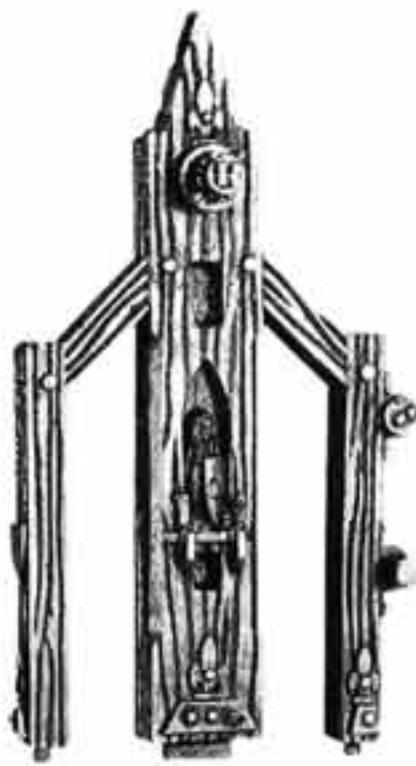

TREBUCHET SIDE 2
9947020309111



TREBUCHET SIDE SUPPORT
9947020309113



TREBUCHET CRADLE/ROCK
9947020309114



TREBUCHET WINCH
9947020309115



TREBUCHET TRIGGER
9947020309116



TREBUCHET WINDLASS
9947020309117

TACTICS

TIPS FOR WINNING WITH BRETONNIANS



- A. A Bretonnian Lord with the Virtue of Confidence, the Armor of Agilulf, and the Gauntlet of the Duel makes for a fearsome duelist. This Lord can challenge nearly any enemy character and come out victorious. The Gauntlet ensures that no challenge can be refused; the Virtue allows for rerolls to hit and to Wound; and the Armor gives the Lord a Weapon Skill of 10 (which means that he will hit almost every foe on a 3+). Duelist Lords work best when they tear apart the enemy champions and characters in challenges and lend the full overkill bonus to combat resolution.
- B. A unit of Knights of the Realm led by a Paladin Battle Standard Bearer with the Banner of the Lady and the Virtue of Discipline can be nearly unstoppable! The Banner of the Lady prevents enemy units from claiming bonuses to combat resolution from ranks, while the Virtue of Discipline similarly prevents them from taking the bonus for outnumbering. The Knights, of course, are potent enough to add plenty of combat resolution themselves from their ranks and the Wounds they cause in combat!
- C. A unit of Questing Knights with the Valorous Standard close to the Battle Standard Bearer is the next best thing to being *Unbreakable*. Questing Knights are normally able to reroll failed Psychology Tests, and the proximity of the Battle Standard will allow them to reroll Break Tests as well. The Valorous Standard gives them the best two dice of 3D6 for any Leadership roll.

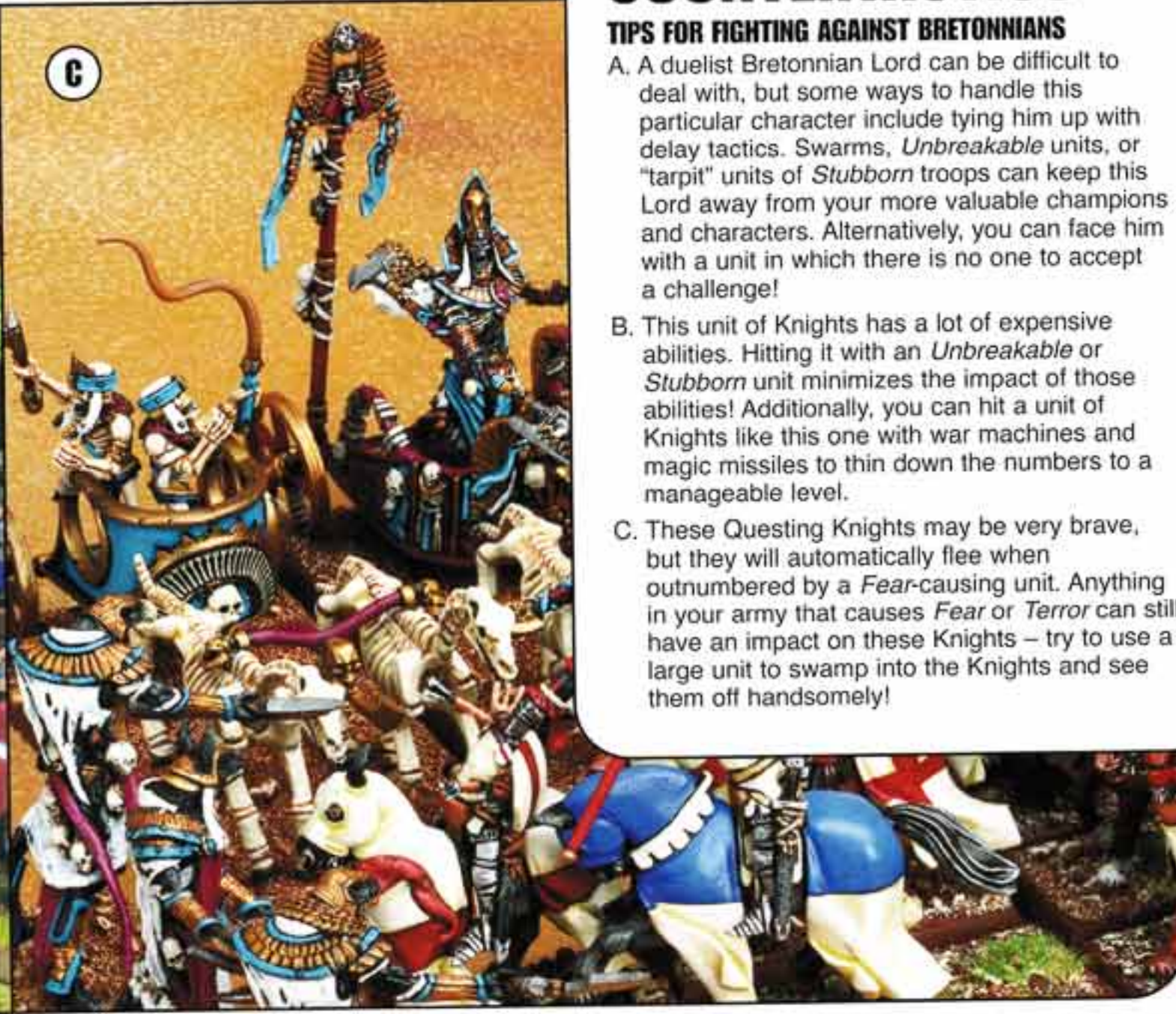
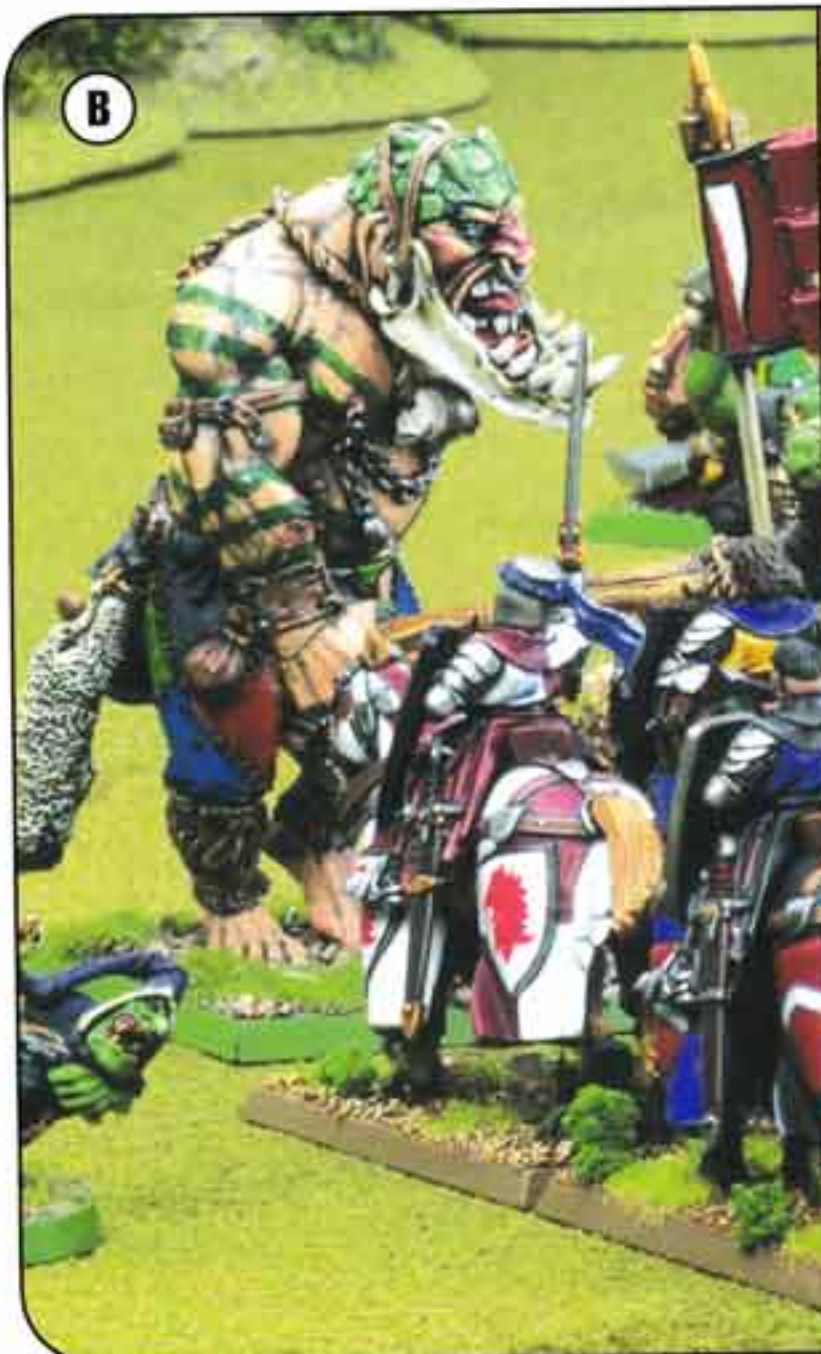

COUNTERTACTICS

TIPS FOR FIGHTING AGAINST BRETONNIANS

- A. A duelist Bretonnian Lord can be difficult to deal with, but some ways to handle this particular character include tying him up with delay tactics. Swarms, *Unbreakable* units, or "tarpit" units of *Stubborn* troops can keep this Lord away from your more valuable champions and characters. Alternatively, you can face him with a unit in which there is no one to accept a challenge!
- B. This unit of Knights has a lot of expensive abilities. Hitting it with an *Unbreakable* or *Stubborn* unit minimizes the impact of those abilities! Additionally, you can hit a unit of Knights like this one with war machines and magic missiles to thin down the numbers to a manageable level.
- C. These Questing Knights may be very brave, but they will automatically flee when outnumbered by a *Fear*-causing unit. Anything in your army that causes *Fear* or *Terror* can still have an impact on these Knights – try to use a large unit to swamp into the Knights and see them off handsomely!



COLORS OF WAR

KEY

Top Box(es): Basecoat Colors & Ink Washes
 Bottom Box(es): Highlights
 Mixed Colors



*Scorched Brown, Snakebite
Leather, Catachan Green
Kommando Khaki, Bleached
Bone, Rotting Flesh*



*Scab Red, Fortress Grey, Scorched Brown
Blood Red, Skull White, Vomit Brown*



*Shadow Grey, Chaos Black
Skull White, Codex Grey*



*Enchanted Blue, Chainmail
Ice Blue, Skull White*



*Golden Yellow, Enchanted Blue
Sunburst Yellow, Ice Blue*

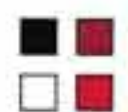

*Chaos Black, Red Gore
Skull White, Blood Red*

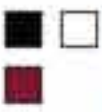

*Chaos Black, Skull White
Scab Red*



*Chaos Black, Red Gore
Skull White*



*Chaos Black, Enchanted Blue
Golden Yellow*

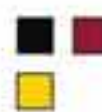

*Chaos Black, Red Gore
Golden Yellow*

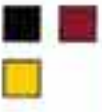

*Chaos Black, Red Gore
Golden Yellow*

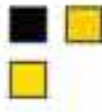

*Chaos Black, Golden Yellow
Sunburst Yellow*



*Chaos Black, Dwarf Bronze
Burnished Gold*



*Chaos Black
Skull White*

ALTERNATE MODEL – SPECIAL Grail Pilgrims

COMPONENTS FOR 4 COMPLETE MODELS

- 99380203002 Men-at-Arms Sprue
- 99381102001 Empire Militia Sprue
- 9947020309510 Grail Pilgrim Shield Sp. (x2)

COMPLEXITY RATING



SHOWCASE



Above: Dirk Finger's Bretonnian Questing Knights won third place at the 2004 Los Angeles Games Day Golden Demon Painting Competition.

Left: Liliana Troy won the Slayer Sword at the 2004 Los Angeles Games Day Golden Demon Painting Competition with her Bretonnian Pegasus Knight.



ALTERNATE MODEL – SPECIAL
Mounted Yeomen
COMPONENTS FOR 4 COMPLETE MODELS

99380203002	Men-at-Arms Sprue
99389999003	Medieval Horse Sprue (x4)
99389999013	Medieval Horse Head Sp (x4)
9947020115004	Chariot Driver Spear (x4)
9947020200504	Kislev Horse Archer Legs 2 (x4)
9947111000103	Shadow Warrior Quiver (x4)

COMPLEXITY RATING



THIS CONVERSION CONTAINS THE SPECIAL OFFER BITZ SHOWN HERE
 See the catalog introduction for more information.



SHADOW WARRIOR QUIVER
 9947111000103

DARK ELVES

Far across the Great Ocean to the west of the Old World lies the vast continent of Naggaroth. It is a harsh and rugged wilderness above which dark clouds gather to unleash terrible storms upon the land. Beneath the massive mountain ranges lie a huge network of underground caverns through which the Dark Elves sail their dread Black Arks to launch surprise raids on the distant kingdoms of the Old World and further afield to Nippon and Cathay. But the principle target for Dark Elf invasion is the magical isle of Ulthuan, the majestic homeland of all Elvenkind, from which the Dark Kindred were exiled millennia ago.

Long ago, the Elven realm was split in a horrendous and merciless civil war. The Dark Elves, or Druchii as they called themselves, had their kingdoms destroyed and so retreated to the lands of Naggaroth. From these bleak and desolate lands, the Dark Elves still plot revenge against their fair High Elven cousins and dispatch their black armadas to take slaves and wreak havoc across the whole of the Warhammer world.

Fighting Style

The Dark Elves are a fast and highly skilled race and may field many specialized elite units in their army. There is nothing a Dark Elf army does poorly, except perhaps fighting in long drawn-out battles of attrition. With excellent Ballistic Skill and the dreaded Crossbowmen and Reaper Bolt Throwers, Dark Elves can wear down or even wipe out many enemy units through missile fire. Yet most Dark Elf players choose a more direct method of slaughter, that is, using elite troops like Witch Elves, Cold One Knights, or Executioners to slice through enemy ranks. Harpies, Shades, and Dark Riders are ideal at slowing down enemy advances or in joining in an attack by hitting the enemy's sides or rear.

This Dark Elf Repeater Bolt Thrower was painted by Noel Myer, a 2004 Chicago Golden Demon winner.

Collecting a Dark Elf Army

Players who wish to start collecting a Dark Elf army would do well to begin with some Core troops. This is the best place to start, as not only will such units fulfill the army requirements, but two Core selections will form the natural center of a player's growing army. Dark Elf warriors may be equipped with spears or with repeater crossbows. Defensive-minded Dark Elf players will want lots of both spearmen and crossbowmen, while seriously offensive minded players may wish to add other Core selections like the *Fast Cavalry* Dark Riders or a few units of Corsairs.

Dark Elf generals looking to expand their armies are presented with a surprising number of wicked options. Small units of Shades can act as *Scouts* ahead of the main force, while Reaper Bolt Throwers are meant

to sit back and rain death upon the foe from afar. Although unarmored, Witch Elves are subject to *Frenzy* and use *Poisoned Attacks*. Furthermore, the Cauldron of Blood, a powerful and evil artifact, can drive all Dark Elves, particularly Witch Elves, into an increased state of battle fury. The hitting power of Cold One Knights is undeniable, as are elite units like the Executioners or Black Guard. Cold One Chariots or massive War Hydras are also great options to put some hurt onto your foe. Character models allow more chances for Dark Elf personality to seep into an army with choices like Assassins, Sorceresses, and Beastmasters.

Prepare the slaves for sacrifice and remember to show no mercy.



These Harpies were painted by Scott Goldstein for his Dark Elf Army, which won him the Players' Choice and Best Appearance awards at the 2003 Seattle Grand Tournament.

GETTING STARTED

Deploying the warriors with spears in the front of the army to prepare for hand-to-hand combat allows the crossbowmen in the back to shoot away at the enemy.



This 80-page rulebook contains painting and modeling guides, background, and the full rules for the Dark Elves. Using this book, you can build a mighty legion and destroy all who challenge you.



**Warhammer
Armies: Dark Elves**
60030212001

Much of the Dark Elf army is raised from the population of the cities. Among the ranks march wives and sisters, beautiful but deadly maidens who fight with the fury of Daemons. Some prefer the repeater crossbow, while others prefer the long, heavy-bladed spear. Each Dark Elf Warrior Regiment Box includes enough bitsz to field a unit of spearmen or crossbowmen 16 strong.



**Dark Elf Warrior
Regiment Box (16)**
99120212001



Once you have your Core units completed, add some specialist units such as a regiment of Executioners.



After starting your Dark Elf army, you may want to add a few specialist units to complement your current Core units. The model shown above to the right is from a regiment of Executioners. These Dark Elves are elite dealers of death wielding custom long blades that can deliver a *Killing Blow* to their enemies. Other units, such as Witch Elves and the fearful Black Guard, are also good choices to complement your Core units. If speed is essential to your army, you can also boost your ranks with Chariots and Cold One Knights.



LORDS & HEROES



Beastmaster on Manticore Box (1)
99110212042



BEASTMASTER HEAD
9947021204208



MANTICORE TAIL
9947021204205



BEASTMASTER SPEAR
9947021204209



MANTICORE BODY
9947021204202



BEASTMASTER BODY
9947021204207



DRAGON WING SPRUE
99380299002



MANTICORE RIGHT CLAW
9947021204201



MANTICORE LEFT CLAW
9947021204203



MANTICORE RIGHT LEG
9947021204204



MANTICORE LEFT LEG
9947021204206

All miniature are supplied unpainted. Models, base, and sprues for all shows actual size unless otherwise stated. Contents may vary slightly from those shown.

LORDS & HEROES

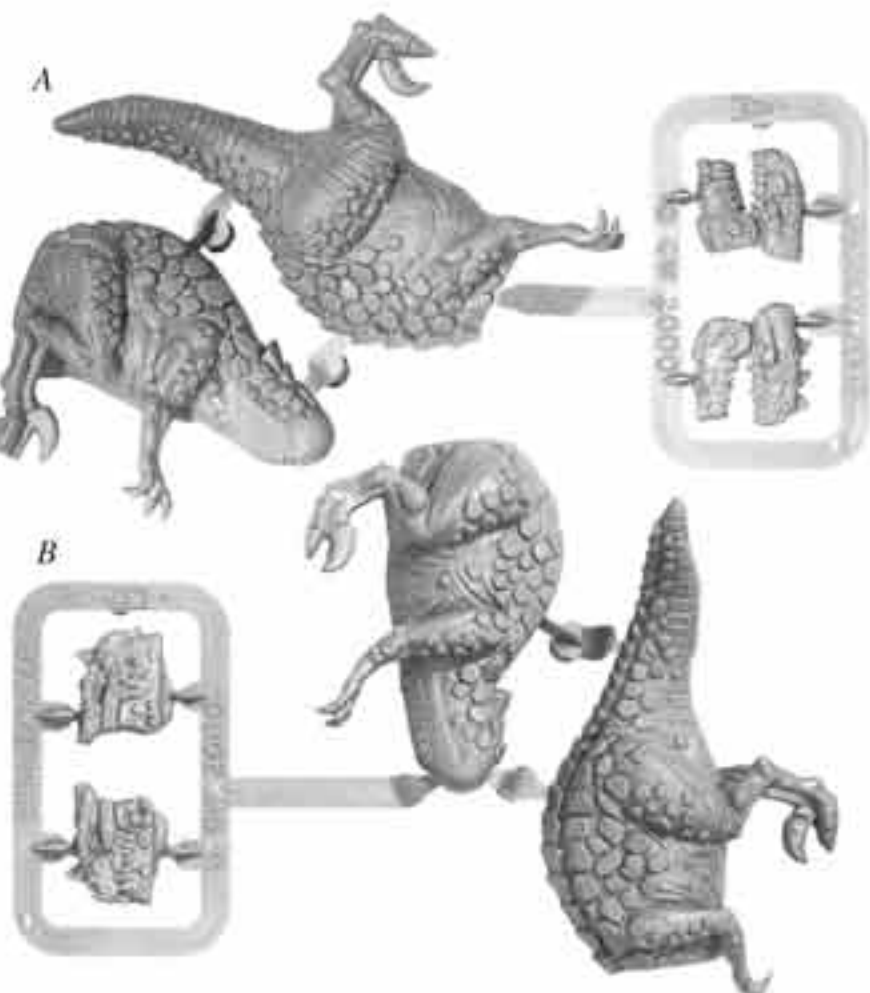

COLD ONE HEAD & BODY SPRUE - RANDOM 1
(SHOWN 75% ACTUAL SIZE)
99380212002



Mounted Sorceress Blister (1)
99060212051



MOUNTED SORCERESS BODY
9947021205101



ASSASSIN SWORD
9947021204305



ASSASSIN CLAW
9947021204304



Assassin Blister (Random 1)
99060212043



ASSASSIN BODY 1
9947021204301



ASSASSIN BODY 2
9947021204302



ASSASSIN BODY 3
9947021204303



BEASTMASTER SPEAR ARM
9947021205703



BEASTMASTER WHIP ARM
9947021205704



Beastmasters Blister (Random 1)
99060212057



BEASTMASTER
W/ WHIP
9947021205701



BEASTMASTER
W/ CLAW
9947021205702



Sorceress Blister (1)
99060212037
BIT NAME: SORCERESS
BIT CODE: 9947021202001

LORDS & HEROES

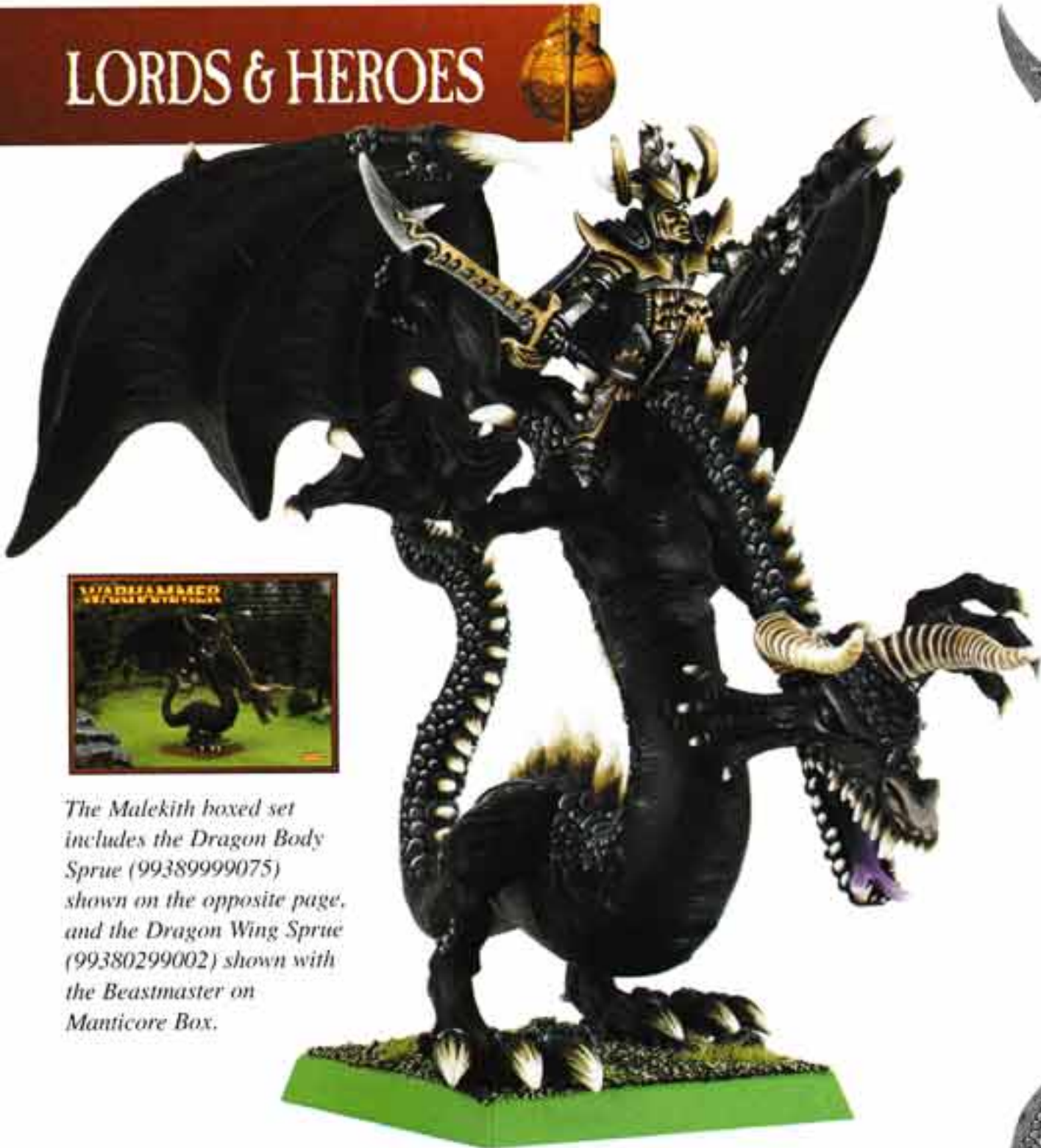

The Malekith boxed set includes the Dragon Body Sprue (99389999075) shown on the opposite page, and the Dragon Wing Sprue (99380299002) shown with the Beastmaster on Manticore Box.

Malekith, Witch King of Naggaroth Box (1)
99110212033



MALEKITH'S BODY
9947021203301



MALEKITH'S HEAD
9947021203302



MALEKITH'S ARM
9947021203303



MALEKITH'S CLOAK
9947021203304



MALEKITH'S SADDLE
9947021203305



BLACK DRAGON TAIL
9947021203313



BLACK DRAGON HORNS
9947021203307

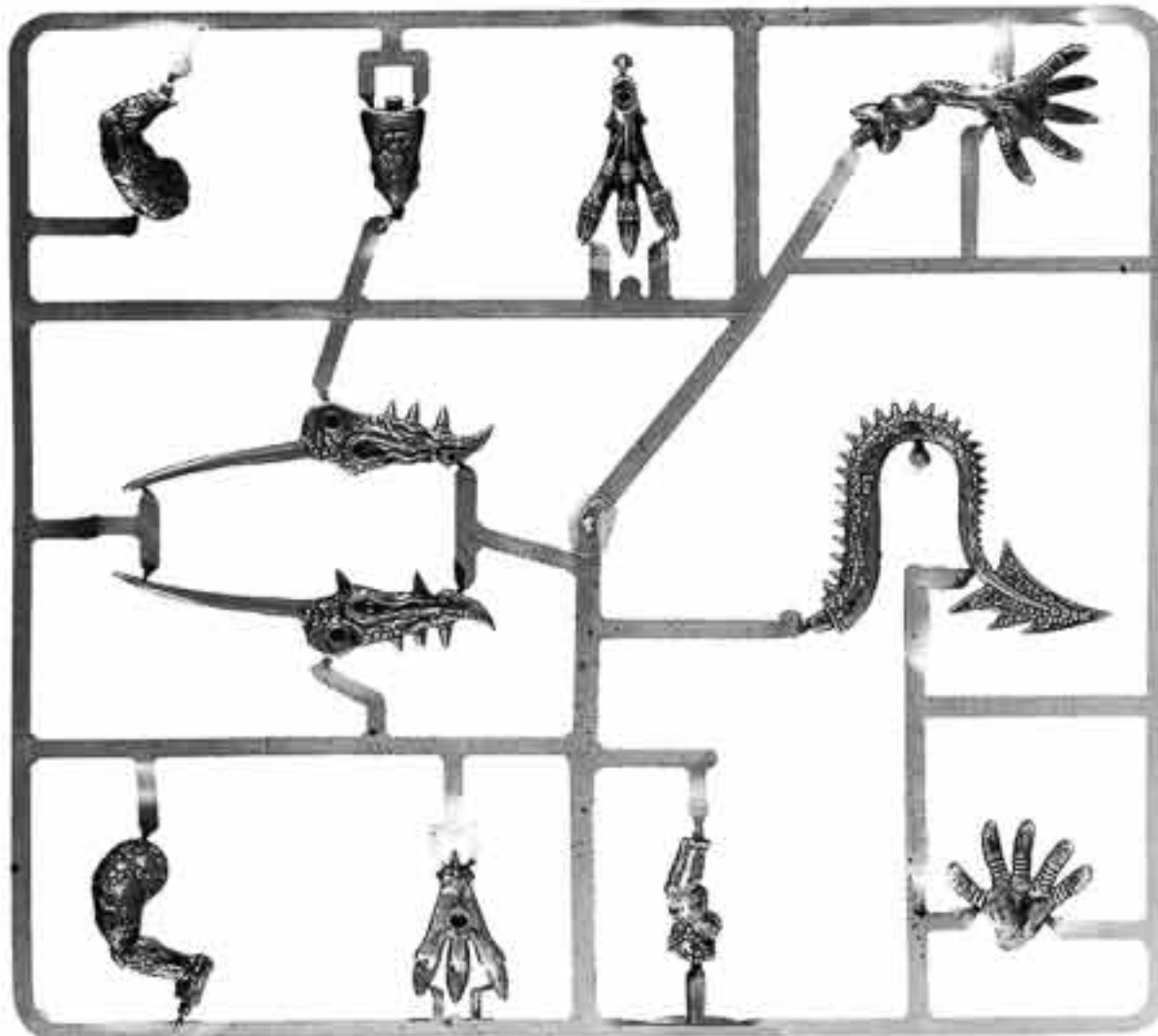

DRAGON LIMBS SPRUE (SHOWN 75% ACTUAL SIZE)
99389999077



BLACK DRAGON LEFT HAND
9947021203312



BLACK DRAGON RIGHT ARM
9947021203311



BLACK DRAGON JAW
9947021203309



BLACK DRAGON HEAD
9947021203310



BLACK DRAGON LEFT FIN
9947021203308



BLACK DRAGON RIGHT FIN
9947021203306

LORDS & HEROES

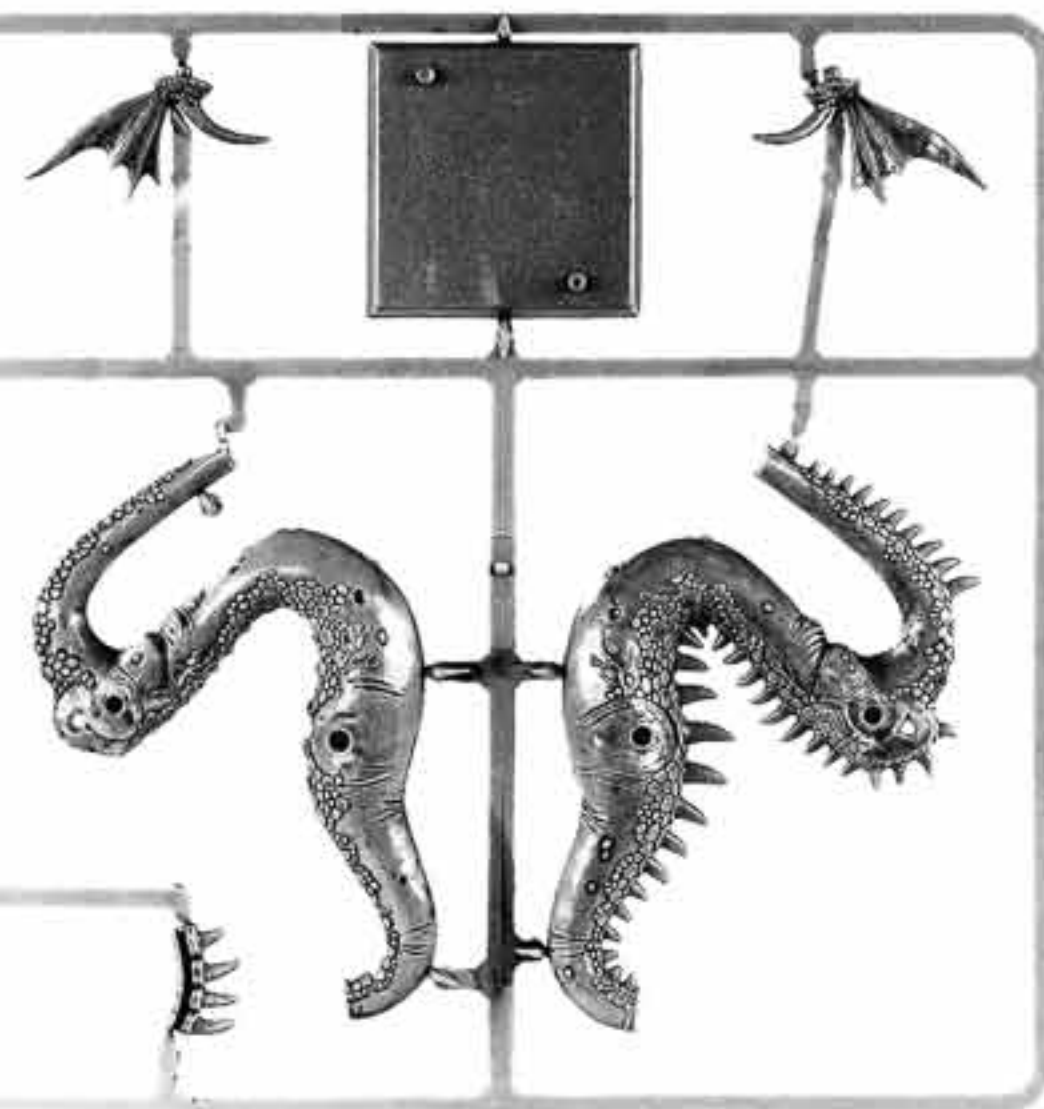

DRAGON BODY SPRUE (SHOWN 75% ACTUAL SIZE)
99389999075



Shadowblade Blister (1)
99060212059



SHADOWBLADE BODY
9947021205901



SHADOWBLADE SWORD
9947021205902

The Malus Darkblade blister includes the Cold One Head & Body Sprue (99380212002) shown with the Mounted Sorceress.



Malus Darkblade Blister (1)
99060212039



COLD ONE JAW
9947021203905



COLD ONE HEAD
9947021203904



MALUS DARKBLADE SWORD
9947021203902



MALUS DARKBLADE CLOAK
9947021203903



MALUS DARKBLADE BODY
9947021203901

PAINTING DARK ELF BANNERS

Here are some examples of Dark Elf banner imagery you can create for your army. First prime the banner and paint the background and highlight with your colors of choice.



STEP 1

Paint the design of the runes (left) with thinned Chaos Black. For the serpent (right), paint an S-shape first, then carefully add in the tongue, horns, and spines on its back.

STEP 2

Use thinned Skull White to complete the runes. Paint the serpent with several layers of thinned Blood Red. Take care to leave a small black line around the edges on both.



STEP 3

Highlight the serpent with thinned Blazing Orange.



STEP 4

Highlight the serpent with Golden Yellow. Add a small black dot to suggest an eye. Adventurous painters might want to try adding a fully painted eye to their banners.





LORDS & HEROES



MORATHI HEAD
9947021205802



MORATHI HAIR
9947021205803



DARK PEGASUS LEFT SIDE
9947021205805



MORATHI BODY
9947021205801



DARK PEGASUS HEAD
9947021205806



Morathi Blister (1)
99060212058



DARK PEGASUS RIGHT SIDE
9947021205804



DARK PEGASUS LEFT WING
9947021205808



DARK PEGASUS RIGHT WING
9947021205807





CORE UNITS

PAINTING DARK ELF WARRIORS

First, assemble the model and spray it with Chaos Black Primer before you begin.



STEP 1

Drybrush the chain mail and paint all of the metal parts with Boltgun Metal. Paint all of the exposed skin Bestial Brown and the clothing Liche Purple.

STEP 2

Highlight the armor and any metal with Chainmail. Highlight the skin with Bronzed Flesh and paint the leather pieces Bestial Brown. Add Skull White to Liche Purple so you have a 25/75 mix and highlight the clothing.



STEP 3

Highlight the chain mail, armor, and metal with Mithril Silver and add a final highlight of Elf Flesh to the skin areas. Mix Skull White and Liche Purple in a 50/50 mix and add a final highlight to the clothing. Add Vermin Brown to the leather areas and Codex Grey for the spear haft.

STEP 4

Highlight the shoes with thinned-down Codex Grey and add a bit of Fortress Grey to highlight the spear haft. Paint the base Goblin Green. Add flock or static grass to finish off the model.

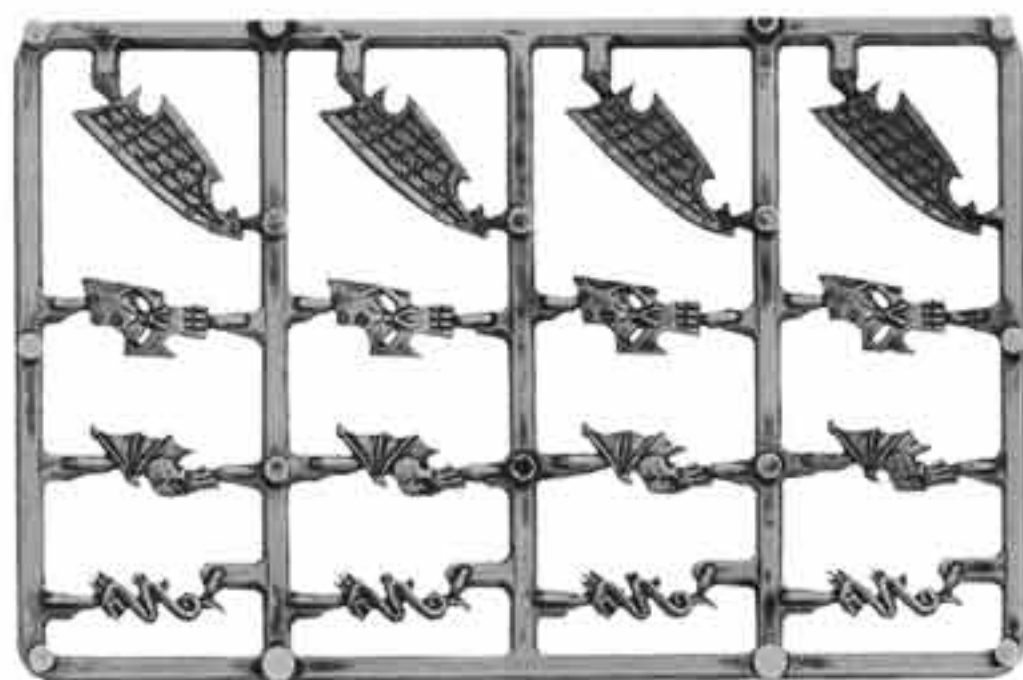

DARK ELF SHIELD SPRUE (SHOWN 85% ACTUAL SIZE)
99360299009



Dark Elf Warrior
Regiment Box (16)
99120212001

You can also create a regiment of crossbowmen from the Dark Elf Warrior Regiment boxed set. See the Getting Started section for an example.

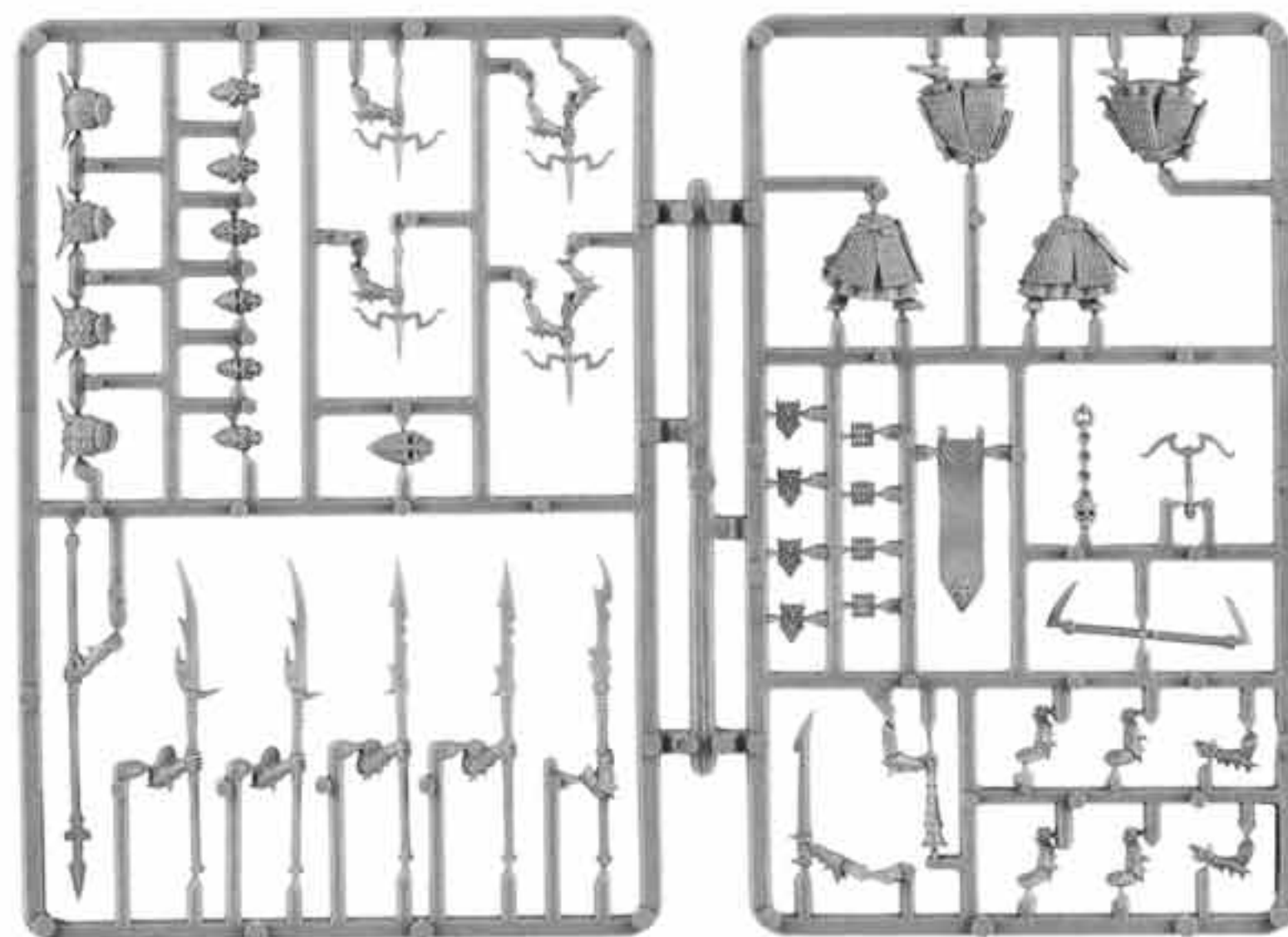

DARK ELF WARRIOR SPRUE (SHOWN 85% ACTUAL SIZE)
99380212001



CORE UNITS



The Dark Elf Corsair Command Blister contains one random Champion, the Standard Bearer, and the Musician.



Dark Elf Corsairs Regiment Box (10) & Dark Elf Corsairs Command Blister (3)
99110212034 99060212035



CORSAIR CHAMPION 1
9947021203504



CORSAIR CHAMPION 2
9947021203505



CORSAIR STANDARD BEARER
9947021203501



CORSAIR STANDARD
9947021203502



CORSAIR MUSICIAN
9947021203503



CORSAIR CHAMPION 3
9947021203506



CORSAIR 1
9947021203401



CORSAIR 2
9947021203402



CORSAIR 3
9947021203403



CORSAIR 4
9947021203404

CORE UNITS



Dark Rider Blister (Random 1) & Dark Rider Command Blister (1)
99060212054 99060212055



DARK RIDER HORN
9947021205505



DARK RIDER CHAMPION SWORD
9947021205503



DARK RIDER CROSSBOW
9947021205506



DARK RIDER 1
9947021201701



DARK RIDER 2
9947021201702



DARK RIDER 3
9947021201703



DARK RIDER 4
9947021201704



DARK RIDER STANDARD
9947021205504



DARK RIDER COMMAND 1
9947021205501



DARK RIDER COMMAND 2
9947021205502



ELVEN STEED HEAD
99389999015



ELVEN STEED SPRUE
99389999005



SPECIAL UNITS

The Cold One Chariot boxed set includes the Cold One Head & Body Sprue (99380212002) shown with the Mounted Sorceress and the Beastmaster Whip Arm (9947021205704) shown with the Beastmasters.



Cold One Chariot Box (1)
99110212050



CHARIOT CREW 1 BODY
9947021205012



CHARIOT DRIVER BODY
9947021205014



CHARIOT CREW 1 SPEAR
9947021205013



CHARIOT LEFT SIDE
9947021205002



CHARIOT RIGHT SIDE
9947021205004



CHARIOT HAFT
9947021205005



CHARIOT YOKE
9947021205006



CHARIOT TROPHIES
9947021205011



CHARIOT BASE
9947021205001



CHARIOT FRONT
9947021205003



CHARIOT BANNER POLE
9947021205007



CHARIOT BLADES
9947021205009



CHARIOT SPEAR RACK
9947021205008



7-SPOKED WHEEL SPRUE
99399999001



CHARIOT CROSSBOW
9947021205010

SPECIAL UNITS



Dark Elf Witches Regiment Box (10) & Dark Elf Witches Command Blister (3)
99110212036

99060212040



DARK ELF WITCH CHAMPION
9947021204001



DARK ELF WITCH HORNBLOWER
9947021204003



DARK ELF WITCH 1
9947021203601



DARK ELF WITCH 2
9947021203602



DARK ELF WITCH 3
9947021203603



DARK ELF WITCH 4
9947021203604



DARK ELF WITCH 5
9947021203605



DARK ELF WITCH STANDARD BEARER
9947021204002



Dark Elf Harpies Blister (Random 2)
99060212048



HARPY BODY 1
9947021204801



HARPY BODY 2
9947021204802



HARPY WINGS 1
9947021204805



HARPY WINGS 2
9947021204806



HARPY BODY 3
9947021204803



HARPY BODY 4
9947021204804



SPECIAL UNITS

PAINTING COLD ONES

The scales and skin on the Cold Ones come in a variety of colors. Here is an example of a green and brown color scheme that you can try. For more color schemes and ideas, check out the *Colors of War* pages at the back of the Dark Elf section.



STEP 1

Prime with Skull White spray and paint the model with a slightly thinned layer of Snot Green. Wash the model with Dark Angels Green.



STEP 2

Paint highlights of Snot Green all over the model.



STEP 3

Paint the scales Catachan Green. It's a matter of choice whether you paint the scales individually and leave the skin color showing in between the scales, or paint the entire area the color of the scales.

We chose to do a combination of both. Our scale color covers the scales and skin at the top of the Cold One. At the bottom of the model, the scale color covers only the scales.



STEP 4

Apply a 75/25 mix of Catachan Green and Camo Green as the first highlight on the scales.



STEP 5

Paint a final highlight of 25/75 Catachan Green and Camo Green on the edges of the scales.



Executioners Box (10) & Executioners Command Blister (3)
99110212052 99060212053



EXECUTIONER BLADE 1
9947021205205



EXECUTIONER SWORD
9947021205302



EXECUTIONER BLADE 2
9947021205206



EXECUTIONER BANNER
9947021205304



EXECUTIONER CHAMPION
9947021205301



EXECUTIONER MUSICIAN
9947021205305



EXECUTIONER STANDARD BEARER
9947021205303



EXECUTIONER 1
9947021205201



EXECUTIONER 2
9947021205202



EXECUTIONER 3
9947021205203



EXECUTIONER 4
9947021205204



Cold One Knights include the Cold One Head & Body Sprue (99380212002) shown with the Mounted Sorceress.



SPECIAL UNITS



Cold One Knights Box (4)
99110212060

The Cold One Knights boxed set includes bits to create any combination of Cold One Knights and command (up to four models).



COLD ONE KNIGHT COMMAND SWORD
9947021204703



COLD ONE KNIGHT COMMAND HORN
9947021204704



COLD ONE KNIGHT SHIELD 1
9947021204606



COLD ONE KNIGHT SHIELD 2
9947021204607



COLD ONE KNIGHT SHIELD 3
9947021204608



COLD ONE KNIGHT SHIELD 4
9947021204609



COLD ONE KNIGHT CHAMPION BODY
9947021204701



COLD ONE KNIGHT COMMAND STANDARD
9947021204702



COLD ONE KNIGHT 1
9947021204601



COLD ONE KNIGHT 2
9947021204602



COLD ONE KNIGHT 3
9947021204603



COLD ONE KNIGHT LANCE 1
9947021204604



COLD ONE KNIGHT LANCE 2
9947021204605



SPECIAL UNITS



Dark Elf Shades Blister (Random 3)
99060212056



SHADE BODY 1
9947021205601



SHADE BODY 2
9947021205602



SHADE BODY 3
9947021205603



SHADE CROSSBOW
9947021205606



SHADE BODY 4
9947021205604



SHADE BODY 5
9947021205605

RARE UNITS



Repeater Bolt Thrower Blister (1)
99060212038



BOLT THROWER WINDLASS
9947021203802



BOLT THROWER COMMANDER
9947021203806



BOLT THROWER FIRING PIN
9947021203805



BOLT THROWER BOW
9947021203804



BOLT THROWER LEGS
9947021203801



BOLT THROWER STOCK
9947021203803



BOLT THROWER LOADER 1
9947021203807



BOLT THROWER LOADER 2
9947021203808

RARE UNITS



Black Guard Box (10) & Black Guard Command Blister (Random 3)
 99110212044 99060212045



BLACK GUARD CHAMPION BODY 1
 9947021204501



BLACK GUARD CHAMPION BODY 2
 9947021204502



BLACK GUARD CHAMPION HALBERD
 9947021204504



BLACK GUARD CHAMPION SWORD
 9947021204503



BLACK GUARD STANDARD
 9947021204506



BLACK GUARD STANDARD BEARER
 9947021204505



BLACK GUARD DRUMMER 1
 9947021204507



BLACK GUARD DRUMMER 2
 9947021204508



BLACK GUARD HALBERD 2
 9947021204404



BLACK GUARD HALBERD 1
 9947021204402



BLACK GUARD BODY 2
 9947021204401



BLACK GUARD BODY 3
 9947021204403



BLACK GUARD BODY 5
 9947021204405



BLACK GUARD BODY 6
 9947021204406



RARE UNITS



The War Hydra boxed set includes the Beastmaster Whip Arm and Beastmaster Spear Arm (9947021205703 and 9947021205704) shown in the Lords & Heroes section.



War Hydra Box (1)
99110212049



WAR HYDRA FRONT BODY
9947021204909



WAR HYDRA REAR BODY
9947021204910



WAR HYDRA HEAD 1
9947021204901



WAR HYDRA NECK 1
9947021204902



WAR HYDRA HEAD & NECK 2
9947021204903



WAR HYDRA HEAD & NECK 3
9947021204904



WAR HYDRA LEFT FRONT LEG
9947021204911



WAR HYDRA RIGHT FRONT LEG
9947021204912



WAR HYDRA RIGHT REAR LEG
9947021204913



WAR HYDRA HEAD 4
9947021204905



WAR HYDRA NECK 4
9947021204906



WAR HYDRA HEAD 5
9947021204907



WAR HYDRA NECK 5
9947021204908



BEASTMASTER W/ CLAW
9947021204914



BEASTMASTER W/ WHIP
9947021204915

RARE UNITS



CAULDRON BASE
9947021204101



CAULDRON STATUE OF KHAINE
9947021204102



Cauldron of Blood Box (1)
99110212041



CAULDRON BOTTOM
9947021204105



CAULDRON TOP
9947021204106



CAULDRON RIGHT ARM
9947021204104



CAULDRON CANDLES 1
9947021204107



CAULDRON CANDLES 2
9947021204108



CAULDRON LEFT ARM
9947021204103



CAULDRON GUARDIAN 1
9947021204109



CAULDRON GUARDIAN 2
9947021204110



CAULDRON HAG QUEEN
9947021204111



COLORS OF WAR



KEY

■ Top Box(es): Basecoat Colors & Ink Washes

■ Bottom Box(es): Highlights

■ Mixed Colors



*Dwarf Bronze, Chaos Black
Burnished Gold, Mithril Silver*



*Chaos Black
Scaly Green & Skull White*



*Red Gore, Regal Blue
Blood Red, Enchanted Blue*



*Brazen Brass, Boltgun Metal
Shining Gold, Chainmail*



*Boltgun Metal, Bubonic Brown
Mithril Silver, Bubonic Brown
& Bleached Bone*



*Chaos Black, Liche Purple
Codex Grey, Liche Purple & Skull White*



*Scaly Green, Liche Purple
Scaly Green & Skull White,
Liche Purple & Skull White*



*Bleached Bone, Chaos Black
Skull White, Fortress Grey*



*Chaos Black, Brazen Brass
Shadow Grey, Shining Gold*



*Blood Red, Chaos Black
Skull White*



*Dark Angels Green, Bleached Bone
Scorpion Green, Skull White*



*Chaos Black, Blazing Orange
Fortress Grey, Bad Moon Yellow*



*Dark Flesh, Goblin Green
Dwarf Flesh, Scorpion Green*



*Vermin Brown, Fiery Orange
Vomit Brown, Scaly Green*



*Shadow Grey, Red Gore
Fortress Grey, Blood Red*



*Dark Angels Green, Scab Red
Rotting Flesh, Blood Red*



*Chaos Black, Scaly Green
Scaly Green & Skull White*



*Codex Grey, Liche Purple
Skull White, Liche Purple
& Skull White*



*Chaos Black, Liche Purple
Shining Gold, Liche
Purple & Skull White*



*Chaos Black, Shadow Grey
Shadow Grey, Fortress Grey*



*Vermin Brown, Chaos Black
Vomit Brown, Fortress Grey*

TACTICS

TIPS FOR WINNING WITH DARK ELVES



- A. The Dark Elves can create an army with an insane amount of maneuverability. A Lord on a Black Dragon and a Beastmaster on a Manticore give you two *Terror*-causing Flyers, while Dark Riders, Shades, and Harpies can all add to the number of units you can zip around the battlefield. Some opponents (e.g., Dwarfs and artillery-heavy Empire armies) can find an Dark Elf army like this one extremely difficult to fight. Few other armies are as mobile.
- B. Executioners can take on many opponents thanks to their *Killing Blow* ability. Even tough opponents like Chaos Warriors will fall when the great weapons of the Executioners begin to swing. Consider placing these Druchii at the center of your lines where you can quickly maneuver to engage enemy units.
- C. If you deploy the Cauldron of Blood in a forward position, you can extend the range of its *Red Fury* ability to cover most of the battlefield.



COUNTERTACTICS

TIPS FOR FIGHTING AGAINST DARK ELVES

- A. Deploying your army defensively in a corner is one way to counter a mobile army. Just hunker down, sit tight, shoot as much as possible, and swarm the Dark Elves when they reach your lines.
- B. As long as the Executioners don't get to charge, they'll be swinging last due to their great weapons. In addition, shooting can reduce the numbers of these fairly expensive models before you have to deal with them in combat.
- C. The Cauldron of Blood is a fairly expensive proposal. It's a 205-point unit that won't be fighting unless you charge it. Models with high Toughness can generally ignore its effects and concentrate on killing the rest of the Dark Elf army. Another tactic is to deploy in the corner and avoid the effects of the Cauldron's *Red Fury* ability.





SHOWCASE

Right: This Cauldron of Blood diorama won Pablo Castilla San Martin the Slayer Sword at the Spanish Golden Demon in 2001.



Above: These four Shades are from Scott Goldstein's Grand Tournament Army. Scott's Dark Elf Army won the Player's Choice and Best Appearance awards at the 2003 Seattle Grand Tournament.

Below & Far Right: Zach Lanier won third place for his Dark Elf Black Guard regiment at the 2004 Baltimore Golden Demon painting competition.



SHOWCASE



Right: Philippe Renaude painted this Dark Elf Sorceress.



Right: Keith Robertson used a High Elf model and painted the skin like a Dark Elf.



ALTERNATE MODEL – SPECIAL
Witch Elves

COMPONENTS FOR 4 COMPLETE MODELS

- 9947011200101 Dark Eldar Wych Succubus
- 9947011200111 Dark Eldar Wych 5 Shoulder
- 9947011201801 Wych w/ Hydra Knives 1
- 9947011201803 Wych w/ Shardnet 1
- 9947011201804 Dark Eldar Wych Impaler Arm
- 9947021204304 Dark Elf Assassin Claw
- 9947021204305 Dark Elf Assassin Sword
- 9947021204915 Beastmaster w/ Whip
- 9947021205206 Dark Elf Executioner Blade 2
- 9947021205702 Beastmaster w/ Claw

COMPLEXITY RATING



Above: Doug Bissett did a great job on this Malekith model mounted on a Black Dragon.



ALTERNATE MODEL – CORE
Dark Elf City Guard

COMPONENTS FOR 8 COMPLETE MODELS

- 99380210002 High Elf Archers Sprue
- 99380212001 Dark Elf Warrior Sprue
- 99360299009 Dark Elf Shield Sprue (x2)

COMPLEXITY RATING





DOGS OF WAR



Special Offer Only Section (excluding Ruglud's Armored Orcs, Golgfag's Mercenary Ogres, and Mengil Manhide's Manlayers.)

Captain Pugnio watched the battle in the valley below with a certain amount of cool professionalism. His force, which amounted to several hardened units of Pikemen, a smattering of Crossbowmen, and a particularly ferocious group of Ogres, had offered its services to both sides in the fighting below.

The Dwarfs had been too penny-pinching cheap and were hoping to win the battle against the ratmen by themselves and keep their stubby little hands on all their gold! The Skaven, on the other side, had been shrewd negotiators until it turned out that all they had for trade at the moment were glowing green rocks – certainly of no use to my treasure-seeking fighters, thought Captain Pugnio.

Still, if the Dwarfs suddenly gave the signal (by waving a red flag), then Pugnio's Dogs of War were hired. If the Skaven gave the signal (by waving a blue flag), then also, Pugnio's lads were being paid to fight. As the battle swayed back and forth in the valley below, Pugnio was fairly certain that the third option was going to be the best. Let those fools whittle each other down and then fall on them and destroy them all. The only problem, thought Captain Pugnio, is where to sell those cursed glowing rocks.

The Warhammer world is a violent and turbulent place, where realms are constantly beset by attacks. The Dogs of War are literally roving armies for hire, sell-sword mercenaries who will risk their lives for profit! Some of these Dogs of War are merely cutthroat bandits, but others are professional fighters from faraway and exotic lands. Tilea, one of the kingdoms of the Old World, is especially famous for producing mercenaries, although bands of warriors come from many races and countless realms from around the Warhammer world.

Using Dogs of War or Building a Dogs of War Army

The Dogs of War are unique in that a player may build an entire Dogs of War army or just add a unit or two of the mercenaries to bolster an existing force. There are such an amazing selection of both troop types and models to choose from that we recommend this army to more experienced Warhammer players. Veteran players will find it challenging to get the most out of such a disparate group of individual units.

Players with existing armies that want to throw a monkey wrench into their foe's plans should consider adding a unit of Dogs of War. Potent Regiments of Renown like Golgfag's Ogres can be a nasty surprise when they turn up in your Empire army! Likewise, cannons, pikemen, cavalry, or missile troops for armies that can't normally field such weapons can shock your opponent into making bad moves!

Take a look at the Dogs of War Army List and Regiments of Renown options in the downloads available at: <http://us.games-workshop.com/games/warhammer/gaming/dogsofwar/default.htm>.

TERMINOLOGY

Terminology. "Dogs of War" is a generic term used to describe mercenaries. The Dogs of War army list is full of generic troop listings (like Pikemen or Ogres). "Regiments of Renown" is a phrase used to refer to famous or especially well known units (like Pirazzo's Lost Legion or Golgfag's Ogres). It is possible to make an entire Dogs of War army without any Regiments of Renown, and likewise, a player can make an entire Dogs of War army with only Regiments of Renown. Existing armies may "hire" either (or both) generic Dogs of War or Regiments of Renown to join their cause.

Dogs of War Disclaimer

The Dogs of War army does not have a current Army book but does have a well prepared army list available at: <http://us.games-workshop.com/games/warhammer/gaming/dogsofwar/default.htm>.

This army list allows players either to field an entire army of Dogs of War or to "hire" a few units to join an existing army. There are some restrictions (e.g., Dwarfs can never fight alongside greenskins), which are fully described in the downloads.

Below: A Gold winner at the 2001 UK Golden Demon painting competition, this mutated giant was painted by Jasper Kuipers.



Above: This Lucrezzia Belladonna model won Thomas David a Silver at the 2000 French Golden Demon.



The Dogs of War attempt to repel the Beastmen Army.

GETTING STARTED

You can find the most current rules for the Dogs of War online at www.games-workshop.com.



LORDS & HEROES



Dark Emissary
Available as Bitz Only



DARK EMISSARY BODY
9947021405001



Mercenary General
Available as Bitz Only



MERCENARY GENERAL HORSE HEAD
9947021400302



DARK EMISSARY HEAD
9947021405002



Truthsayer
Available as a Bit Only
BIT NAME: TRUTHSAYER
BIT CODE: 9947021404901



Hengus the Druid
Available as a Bit Only
BIT NAME: HENGUS THE DRUID
BIT CODE: 9947021404701



MERCENARY GENERAL BODY
9947021400301



ARMORED HORSE BODY & HEAD SPRUE (1 HEAD & 1 RANDOM BODY) (SHOWN 80% ACTUAL SIZE)
99380299004

CHARACTERS



Box & Blister bits are not available separately unless shown.



GHAZAK KHAN WOLF HEAD
9947021404007



Albion Fen Beast Blister (1)
99060214051



Ghazak Khan
Available as Bitz Only



GHAZAK KHAN WOLF LEFT SIDE
9947021404005



GHAZAK KHAN WOLF RIGHT SIDE
9947021404006

Borgio the Besieger comes with the Armored Horse Body & Head Sprue (99380299004) shown with the Mercenary General.



Borgio the Besieger
Available as Bitz Only



GHAZAK KHAN SWORD
9947021404002



GHAZAK KHAN BANNER POLE
9947021404003



GHAZAK KHAN BODY
9947021404001



BORGIO LANCE & SHIELD
9947021402902



BORGIO BODY
9947021402901



GHAZAK KHAN QUIVER
9947021404004



FELIX JAEGER



GOTREK GURNISSON
9947029902501



FELIX BODY
9947029902502



FELIX SWORD
9947029902503



FELIX (ARCHIVE)
9947020500402



GOTREK (ARCHIVE)
9947020500401

Archive Gotrek & Felix Blister (2)
99060205004

Gotrek Gurnisson & Felix Jaeger Blister (2)
99060205103

CHARACTERS

Box & Blister bitz are not available separately unless shown.



Lorenzo Lupo
Available as Bitz Only



Lucrezia Belladonna
Available as Bitz Only



BRETONNIAN HORSE HEAD SPRUE
(SHOWN 80% ACTUAL SIZE)
99389999014



LORENZO LUPO SHIELD
9947021403002



LUCREZZIA BODY
9947021402001



LORENZO LUPO BODY
9947021403001



LUCREZZIA HORSE HEAD
9947021402002

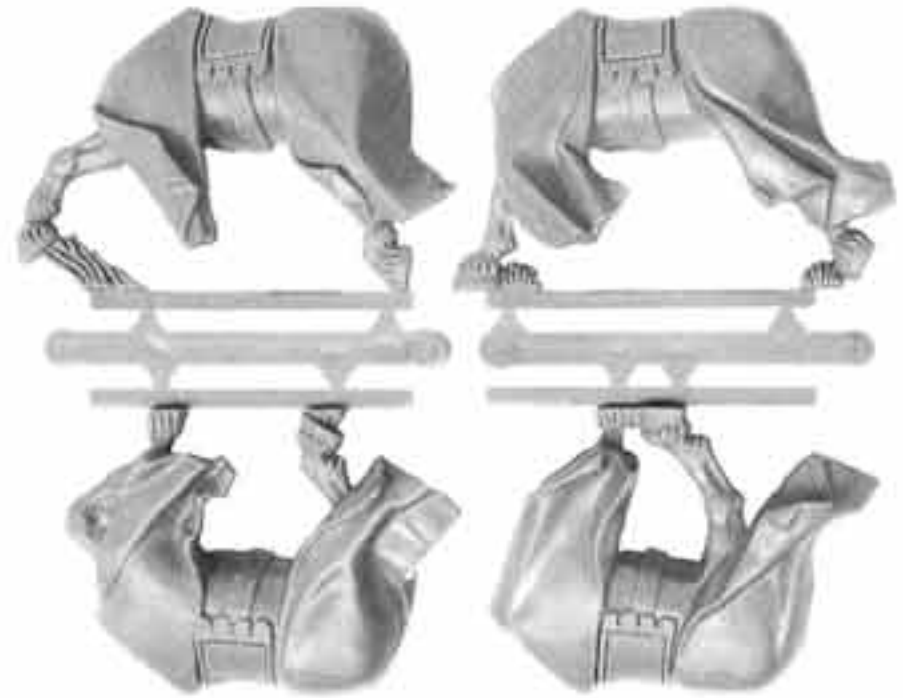

BRETONNIAN HORSE BODY SPRUE
(SHOWN 80% ACTUAL SIZE)
99389999004

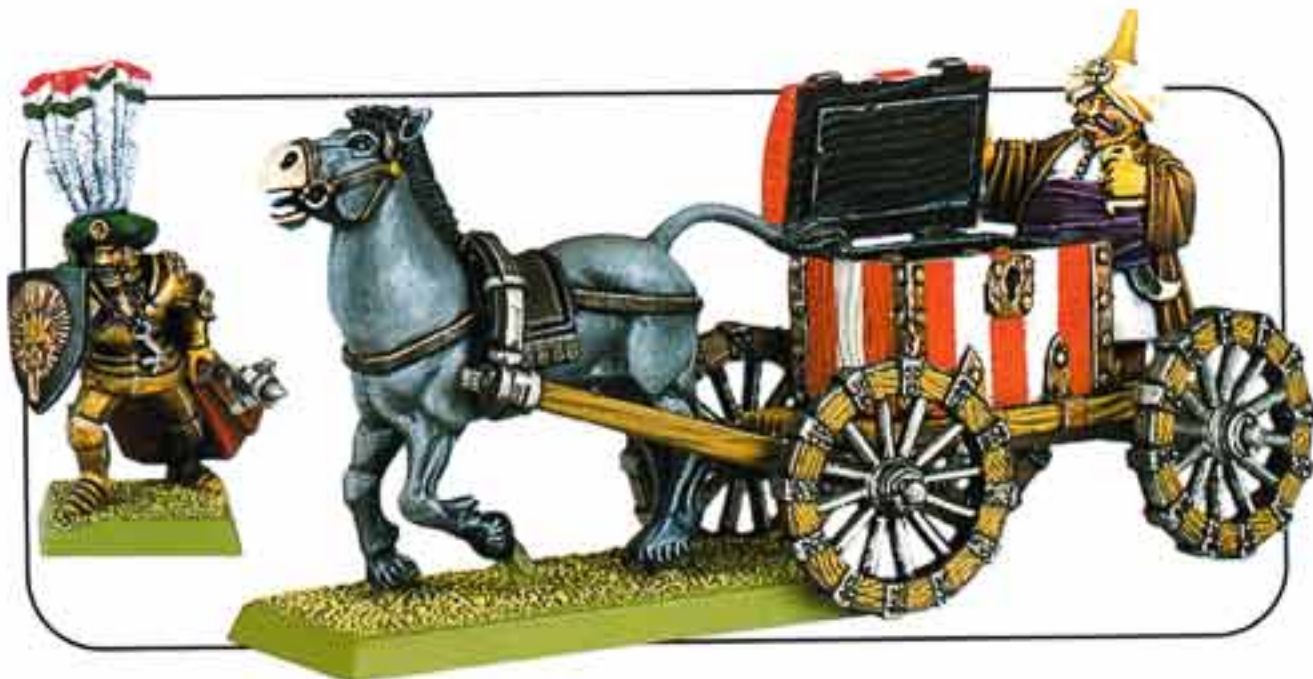

Mydas the Mean Box (1)
99110214022



JOHANN
9947021404401

WILHELM
9947021404402

Witch Hunters
Available as Bitz Only

DOGS OF WAR

Box & Blister bits are not available separately unless shown.



MEDIEVAL HORSE HEAD SPRUE
(SHOWN 80% ACTUAL SIZE)
99389999013



Al Muktar's Desert Dogs Box (5)
99110214006

Al Muktar's Desert Dog Blister (Random 1)
99060214027



MEDIEVAL HORSE BODY SPRUE
(SHOWN 80% ACTUAL SIZE)
99389999003



AL MUKTAR BODY
9947021400601



DESERT DOG SHIELD
9947021400608



Alcatani Fellowship Pikemen Regiment Box (12)
99110214001



RODERIGO DELMONTE HAMMER ARM
9947021400102



RODERIGO DELMONTE BODY
9947021400101



RODERIGO DELMONTE DAGGER ARM
9947021400103

Alcatani Pikemen A Blister (99060214016) contains 3 rear ranked pikemen. Alcatani Pikemen B Blister (99060214054) contains 1 front, 1 middle, and 1 rear ranked pikeman.

Alcatani Pikemen A Blister (Random 3)
99060214016

Alcatani Pikemen B Blister (Random 3)
99060214054

Box & Blister bits are not available separately unless shown.



Albion Giant Bologs Box (1)
99110214052

Albion Giant Cachtorr Box (1)
99110214053



GIANT PACK OF HEADS
9947021404704



GIANT HAMMER 1
9947021404702



GIANT HAMMER 2
9947021404703



GIANT 1 TORSO
9947021404707



GIANT BONE KNIFE
9947021404705



GIANT 2 LEFT LEG
9947021404716



GIANT 2 RIGHT LEG
9947021404715



GIANT 1 LEFT ARM
9947021404712



GIANT 1 RIGHT ARM
9947021404711



GIANT 1 LEFT LEG
9947021404710



GIANT 1 RIGHT LEG
9947021404709

DOGS OF WAR

Box & Blister bits are not available separately unless shown.



BEARMEN SHIELD
9947021400705



BEORG BEARSTRUCK ARM
9947021400707



BEORG BEARSTRUCK BODY
9947021400706



Bearnmen of Urslo Regiment Box (12)
99110214007

Bearnmen of Urslo Blister (Random 3)
99060214017



Braganza's Besiegers Regiment Box (12)
99110214013

Braganza's Besiegers Blister (Random 3)
99060214021



LUCA BRAGANZA CROSSBOW
9947021401302



LUCA BRAGANZA BODY
9947021401301



BRONZINO BODY
9947021400501

Bronzino uses the Medieval Horse Body & Head Sprue (99389999003 & 99389999013) shown previously.



BRONZINO HORSE HEAD
9947021400503



BRONZINO ARM
9947021400502



Bronzino's Galloper Guns Blister (1)
99060214015

DOGS OF WAR



Cursed Company Blister (Random 3)
99060207107
Cursed Company Command Blister (3)
99060207108

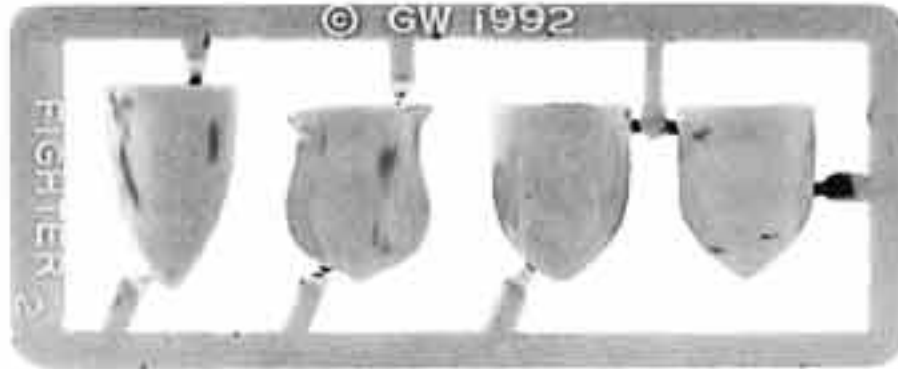

FIGHTER SHIELD SPRUE
99369999003



CURSED COMPANY CHAMPION
9947020710801



CURSED COMPANY MUSICIAN (GOBLIN)
9947020710804



CURSED COMPANY SKAVEN
9947020710703



CURSED COMPANY DWARF
9947020710702



CURSED COMPANY STANDARD BEARER (ELF)
9947020710802



CURSED COMPANY STANDARD BANNER
9947020710803



CURSED COMPANY SAURUS
9947020710704



CURSED COMPANY ORC
9947020710701

PAINTING WOOD GRAIN

By using the following techniques, you'll be able to re-create the look of wood grain on the Galloper Gun and more. We recommend using your finest detail brush and thinning your paint to make the process easier.

STEP 1. After priming black, paint Scorched Brown onto the wood detail. Take care to leave small black lines between the wood grain.



STEP 2. Paint slightly thinned Dark Flesh on top of the Scorched Brown. Again, take care so that the small black lines and the base color show.



STEP 3. Highlight with Bestial Brown. Make sure to leave black lines and some of the base colors showing.



STEP 4. Finally, apply very thin Bubonic Brown lightly as a final highlight.



DOGS OF WAR

Box & Blister bits are not available separately unless shown.



Golgfag's Mercenary Ogres Box (5)

99110214012

Golgfag's Mercenary Ogre Blister (Random 1)

99060214023



Halfling Hot Pot Blister (1)

99060202028



GOLGFAG BODY
9947021401201



GOLGFAG LEFT ARM
9947021401204



HOT POT COOK W/ CLEAVER
9947020202810



GOLGFAG HEAD
9947021401202



GOLGFAG RIGHT ARM
9947021401203



Lumpin Croop's Fighting Cocks Regiment Box (10)

99110214037

Lumpin Croop's Fighting Cocks Blister (Random 3)

99060214038



LUMPIN CROOP BODY
9947021403705



LUMPIN CROOP SHIELD
9947021403706



DOGS OF WAR

Box & Blister bitz are not available separately unless shown.



Halfling Regiment
Available as Bitz Only



HALFLING CHAMPION
9947020202901



HALFLING STANDARD BEARER
9947020202903



HALFLING MUSICIAN
9947020202902



HALFLING W/ SWORD
9947020202704



HALFLING W/ SPEAR 1
9947020202706



HALFLING W/ SPEAR 2
9947020202707



HALFLING W/ BOW 1
9947020202708



HALFLING W/ BOW 2
9947020202709



HALFLING W/ BOW 3
9947020202718



HALFLING W/ BOW 4
9947020202717



HALFLING W/ BOW 5
9947020202715



HALFLING W/ BOW 6
9947020202716

DOGS OF WAR



PAINTING LEOPARD SKIN

Leopold's Company wears leopard skins as cloaks. The base color can be achieved by mixing yellows, oranges, and browns. Follow the steps below for colorful leopard skins and accurate spotting for your entire regiment.

STEP 1

Prime the model black and then apply a 1/1/1 mix of Golden Yellow, Blazing Orange, and Bubonic Brown to the leopard skin.



STEP 2

Apply a 2/1/1 mix of Golden Yellow, Blazing Orange, and Bubonic Brown as the first highlight on all the high areas. Don't worry about trying to highlight each sculpted hair on the skin, because the spots will make such highlights irrelevant.



STEP 3

Add more Golden Yellow to the mix for the next highlight.



STEP 4

Paint straight Golden Yellow onto the very edges of the highlights. As you can see, this step makes the skin appear very vibrant.



STEP 5

Paint black spots of varying size all over the skin. The spots should get smaller and fade into obscurity on the paws, head, and tail.



STEP 6

Apply a 25/75 mix of Chaos Black and Codex Grey to highlight the spots. Simply dab the color into the middle of each spot.



Leopold's Leopard Company Regiment Box (10)
99110214011



LEOPOLDO DI LUCCI BODY
9947021401109



LEOPOLDO DI LUCCI SWORD
9947021401110

Leopold's Pikemen Blister A (3)
99060214024

Leopold's Pikemen Blister B (3)
99060214055

Leopold's Pikemen A Blister (99060214024) contains 3 rear ranked pikemen. Leopold's Pikemen B Blister (99060214055) contains 1 front, 1 middle, and 1 rear ranked pikeman.



Long Drong Slayer's Pirates Regiment Box (12)
99110214010

Long Drong Slayer's Pirates Blister (3)
99060214019



LONG DRONG SLAYER
9947021401007



Mengl Manhide's Manflayers Box (10)
99110212061



MENGL'S BODY
9947021206102



MANFLAYER MUSICIAN BODY
9947021206104



MANFLAYER STANDARD BEARER BODY
9947021206106



MANFLAYER STANDARD
9947021206107



MENGL'S SWORD
9947021206101



MANFLAYER HORN
9947021206105



MENGL'S CROSSBOW
9947021206103



MANFLAYER CROSSBOW
9947021206112



MANFLAYER BODY 1
9947021206108



MANFLAYER BODY 2
9947021206109



MANFLAYER BODY 3
9947021206111



MANFLAYER SWORD 3
9947021206110

DOGS OF WAR

Box & Blister bits are not available separately unless shown.



MAXIMILIAN DAMARK BODY
9947021400201



Marksmen of Miragliano Regiment Box (10)
99110214002

Marksmen of Miragliano Blister (Random 3)
99060214018



MAXIMILIAN RIGHT ARM
9947021400202



PIRAZZO SWORD
9947021403113



PIRAZZO BODY
9947021403112



Pirazzo's Lost Legion Regiment Box (12)
99110214031

Pirazzo's Lost Legion Blister (Random 3)
99060214032



Ricco's Republican Guard Regiment Box (12)
99110214008

Ricco's Republican Guard Blister (Random 3)
99060214026



RICCO ARM
9947021400815



RICCO BODY
9947021400814



Box & Blister bits are not available separately unless shown.



Oglah Khan's Wolfboyz Regiment Box (5)

99110214041

Oglah Khan's Wolfboyz Blister (Random 11)

99060214039



OGLAH KHAN BODY
9947021404110



OGLAH KHAN
QUIVER
9947021404112



OGLAH KHAN CLOAK
9947021404111



WOLFBOY
STANDARD BEARER
9947021204113



WOLFBOY STANDARD
9947021404114



WOLFBOY SPEAR 1
9947021403902



WOLFBOY SPEAR 2
9947021403904

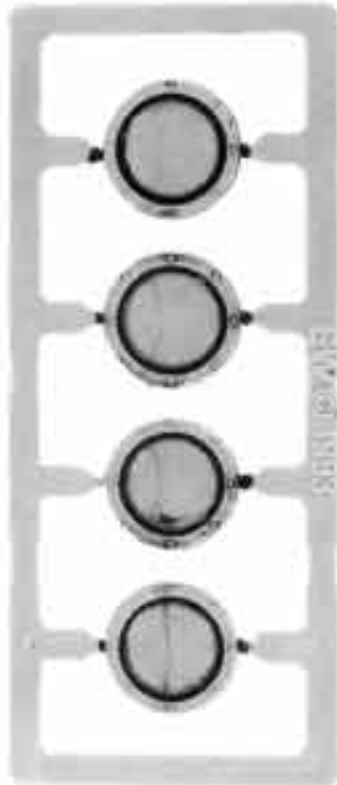

SMALL ROUND
SHIELD SPRUE
99369999004



WOLFBOY
QUIVER 1
9947021403905



WOLFBOY
QUIVER 2
9947021403908



WOLFBOY HORN
9947021404116



WOLFBOY MUSICIAN
9947021204115



© GW 1992



WOLFBOY RIDER 1
9947021203901



WOLFBOY RIDER 2
9947021203903



WOLFBOY RIDER 3
9947021203906



WOLFBOY RIDER 4
9947021203907



WOLF HEAD & BODY SPRUE (RANDOM 1) (SHOWN 80% ACTUAL SIZE)
99380299005

DOGS OF WAR



Box & Blister bits are not available separately unless shown.



**ARMORED ORC
CROSSBOW**
9947020914011

Ruglud's Armored Orcs Regiment Box (10)

99110209140

Ruglud's Armored Orcs Blister (Random 2)

99060209141



RUGLUD HEAD
9947020914002



RUGLUD BODY
9947020914001



RUGLUD MUSICIAN
9947020914005



RUGLUD STANDARD BEARER
9947020914004



RUGLUD ARM
9947020914003



RUGLUD ORC BODY 1
9947020914006



RUGLUD ORC BODY 2
9947020914007



RUGLUD ORC BODY 3
9947020914008



RUGLUD ORC BODY 4
9947020914009



RUGLUD ORC BODY 5
9947020914010



DOGS OF WAR

Box & Blister bits are not available separately unless shown.

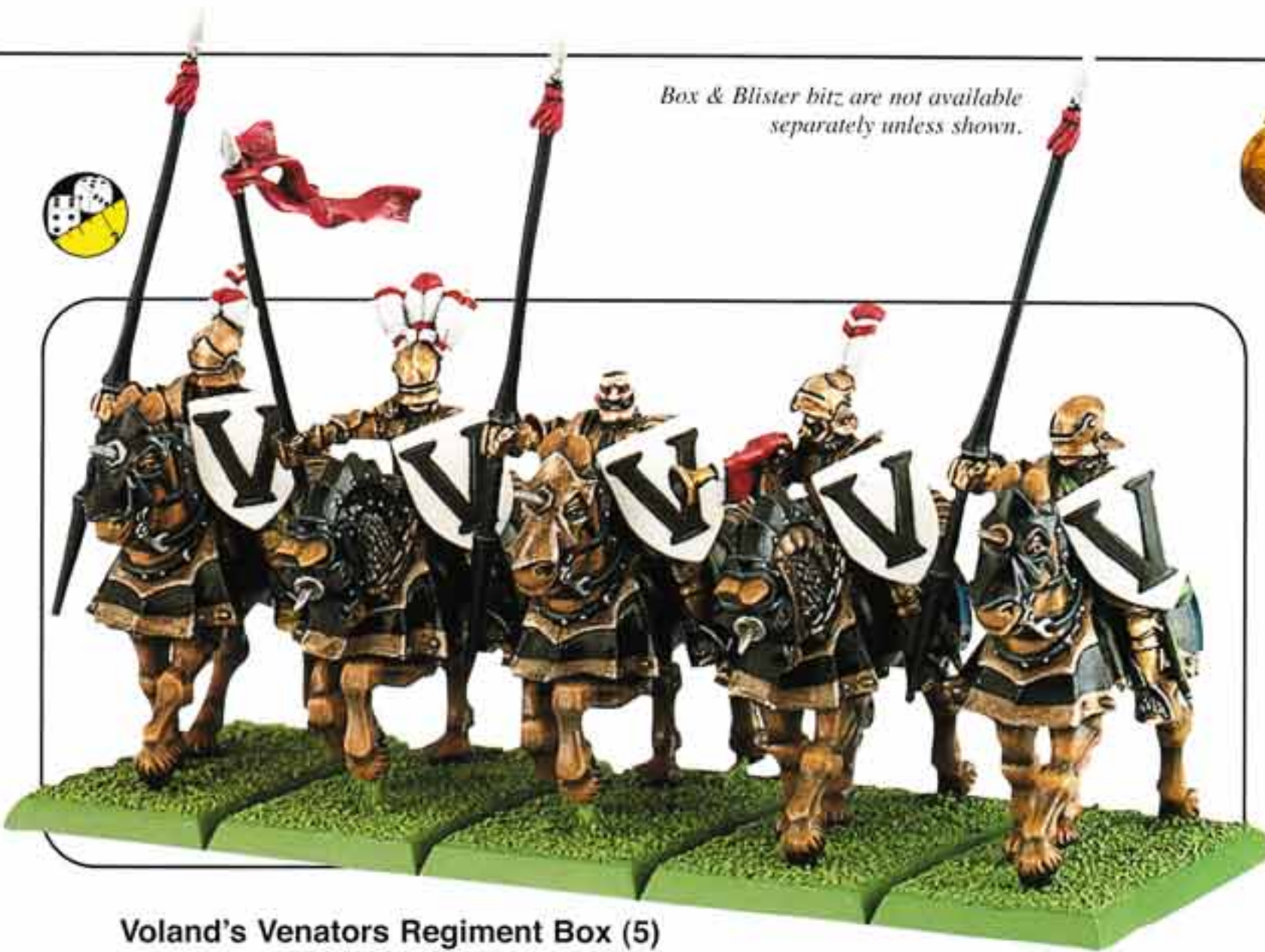

Voland's Venators Regiment Box (5)
99110214033

Voland's Venators Blister (Random 1)
99060214036



VOLAND BODY
9947021403301



VENATOR SHIELD
9947021403306



VENATOR LANCE
9947021403305

Voland requires the Armored Horse Body and Head Sprue (99380299004) shown with the Mercenary General previously.



Vespero's Vendetta Regiment Box (5)
99110214034

Vespero's Vendetta Blister (Random 3)
99060214035



VESPERO BODY
9947021403401



VESPERO ARM
9947021403402



Tichi Huichi's Raiders Regiment Box (5)
99110214042

Tichi Huichi's Raiders Blister (Random 1)
99060214043

COLORS OF WAR

KEY

■ Top Box(es): Basecoat Colors & Ink Washes

■ Bottom Box(es): Highlights

■ Mixed Colors



LORENZO LUPO
Brazen Brass, Skull White
Shining Gold, Blood Red



HENGUS THE DRUID
Codex Grey, Bestial Brown
Fortress Grey, Tanned Flesh



DARK EMISSARY
Dark Flesh, Terracotta
Kommando Khaki, Red Gore



Above: Jeremie Bonamont's converted Lucrezia Belladonna was used as an Empire model for the Storm of Chaos 2004 summer campaign.



VESPERO
Chaos Black, Scab Red
Shadow Grey, Skull White



Left: Will Hahn's Dogs of War Captain won third place at the 2004 LA Golden Demon.

ALTERNATE MODEL – CORE Heavy Cavalry

COMPONENTS FOR 4 COMPLETE MODELS

- 99380299004 Armored Horse Sprue (x4)
- 99390202003 Empire Knights Sprue
- 9947021403002 Lorenzo Lupo Shield (x4)

COMPLEXITY RATING



ALTERNATE MODEL – CORE Duelists

COMPONENTS FOR 4 COMPLETE MODELS

- 99381102001 Empire Militia Sprue (x2)

COMPLEXITY RATING



TACTICS

TIPS FOR WINNING WITH DOGS OF WAR



- A. Pikemen are a great addition to a Dogs of War army – they fight in 4 ranks, strike first, and get +1 Strength against charging enemy cavalry units, chariots, or monsters. If you are facing a cavalry-heavy army (such as High Elves or Bretonnians), Pikemen regiments are an excellent way to go.
- B. Dogs of War Dwarfs are a heck of a buy. For 14 points each, you can get the toughest, bravest crossbowmen in the Warhammer world backed up by heavy armor and a shield.
- C. The Regiments of Renown are too numerous and varied to be listed here individually, but there are many that work very well for a Dogs of War army. Some, like the Giants of Albion, are available only to a Dogs of War army. Regiments of Renown not only add more troops to your forces, they also include Hero-level characters who do not take up a Hero slot in your army and some special rules or magic items of their own. All in all, it's gold well spent.

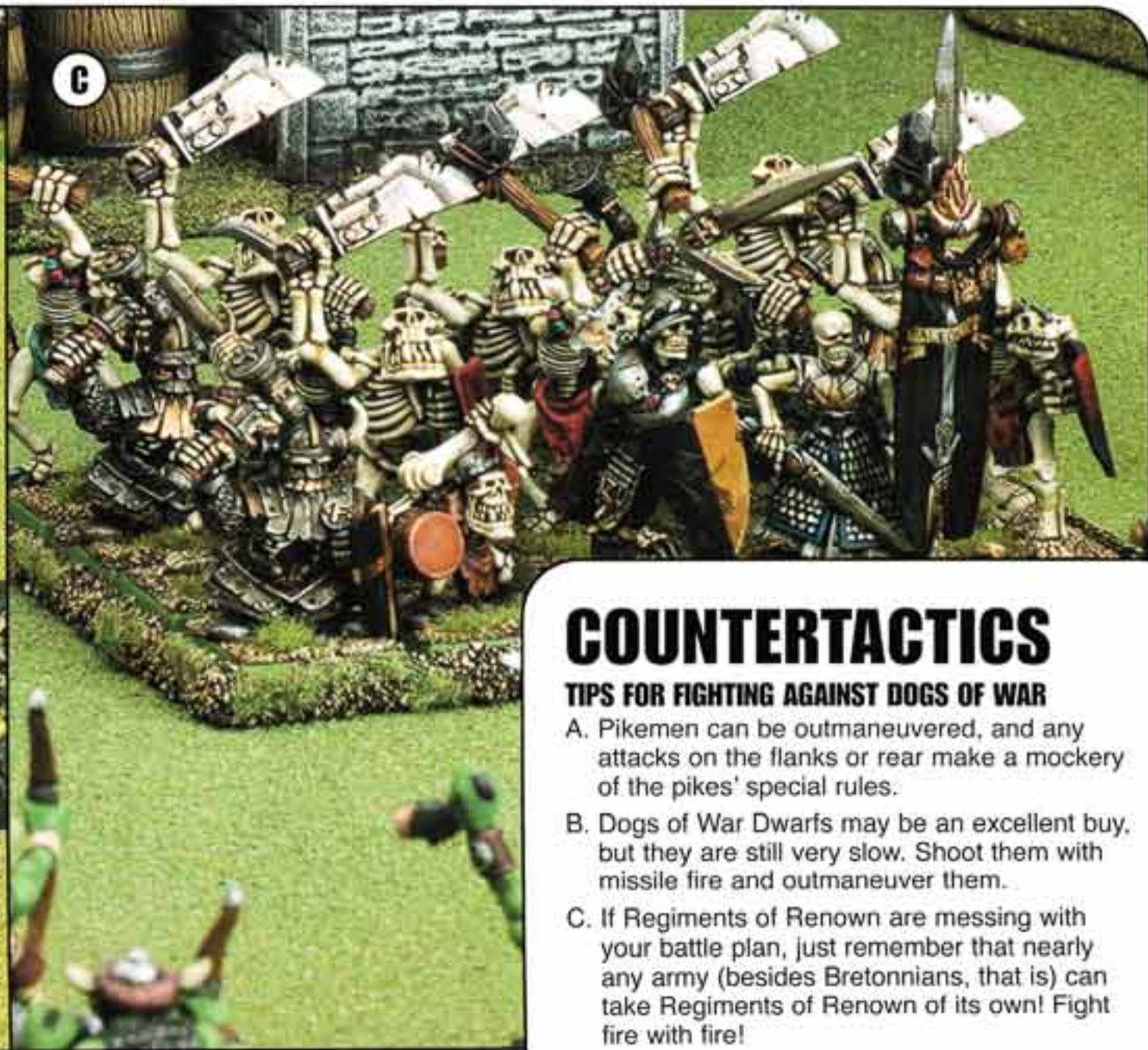

COUNTERTACTICS

TIPS FOR FIGHTING AGAINST DOGS OF WAR

- A. Pikemen can be outmaneuvered, and any attacks on the flanks or rear make a mockery of the pikes' special rules.
- B. Dogs of War Dwarfs may be an excellent buy, but they are still very slow. Shoot them with missile fire and outmaneuver them.
- C. If Regiments of Renown are messing with your battle plan, just remember that nearly any army (besides Bretonnians, that is) can take Regiments of Renown of its own! Fight fire with fire!

DWARFS

No matter who charged – the Boyz, Boar Boyz, or even the huge Giant – nothing could break the Dwarfen center. Fragments of broken Orc units were scattered here and there, and many were in full retreat. Still, the army would escape, as there was no way those cursed beardslings could march over open ground before the Lobbers squished them to jelly.

Just at that moment, with a tremendous crash, part of the hillside slid away to reveal a dark tunnel. From out of the dust, making their way through the rubble, an angry unit of Dwarfs with great picks and fire in their eyes emerged into the light.

Shortly afterward, sitting atop the greenskin corpses and the smashed timbers of the war machines, Burek Ironhelm and his unit of Miners paused to take off their helmets and extinguish the candles affixed on top.

“We were almost too late,” said Burek, while he lit his pipe. “I knew we were supposed to take the LEFT tunnel.”

Dwarfs are well known for their short stature, shorter tempers, and long beards. It is often said (although rarely to their faces) that Dwarfs are as tough and unyielding as their mountainous homes. An ancient race, the Dwarfs once ruled the lands, but long gone are those glory days. Now, many centuries later, the Dwarfs have dwindled but still persevere. Undaunted and unforgiving to enemies of the past, the Dwarfs constantly struggle to rebuild and reclaim their kingdoms of yore.

Fighting Style

Dwarfs make doughty warriors, and their high Leadership, Armor, and Toughness make them determined troops who give ground only begrudgingly. Most Dwarf Generals place their trust in rock-hard infantry blocks, occasionally punctuated by Crossbowmen or Thunderers, as well as a few prized war machines. While all Dwarf Warriors are formidable, the center of the line is often held by elite units. Hammerers are the personal bodyguards of the King. Longbeards are battle-hardened veterans, and Ironbreakers are equipped with nearly impervious magic armor. Any of these units, particularly with the addition of a character or two, can break enemy charges as a rocky cliff breaks the surf. The Dwarfs might be worn down, but it's gonna take a while.

Dwarfs are relentless and seldom tire, but they are not fast. Knowing that they will not surprise and outmaneuver most enemies, veteran commanders often rely on defensive formations and the mutual support of infantry units. There are many variations, but in general, the Dwarf way is to take the enemy's best charge, stand firm, and then unleash a furious counterstrike.

Collecting a Dwarf Army

Our best suggestion about beginning a Dwarf army is to start with your Core choices. As well as fulfilling any minimum requirements, a few Core units are the perfect center for an army, no matter how large you choose to build it. Dwarfs have plenty of Core choices, but with the ability to upgrade to heavy armor and shield (with an impressive 3+ save in hand-to-hand combat), Warriors are a great start. For shooting, there is an age-old Dwarfen debate. Some favor the longer range of the Crossbowmen, while others prefer the better armor penetration of the Thunderers. Also, don't overlook the Scouting ability of Rangers and the amazing *Underground Advance* rule for Miners!

When players are looking to expand their armies, no Dwarf force should march out of the mountains to war without at least one of the superlative infantry Special Units of

Below: Paul Capon's Dwarf Longbeards won second place at UK Games Day 2003.



Below: This Elf Slayer by Ben Bishop won first place at the 2004 Atlanta Games Day.

Hammerers, Longbeards, or Ironbreakers. In addition to being a colorful unit to paint, Slayers make unbreakable anchors to secure a flank or battle line. As the Dwarfs are great builders and technically advanced, war machines often play a large role in Dwarfen battle plan. Choosing from Cannons, Bolt Throwers, Stone Throwers, Gyrocopters, Organ Guns, or Flame Cannons. Dwarfs have a plethora of destructive options. While employing no Wizards of their own, Dwarfs do have Runesmiths (great for defensive magic) and access to plenty of magical Dwarf Runes that may be used to upgrade weapons, armor, war machines, and more.

The history of the Warhammer world is rife with heroic stories of outnumbered Dwarfs holding out against superior numbers. It is now time for new Dwarf Generals to carve their names into legend.

GETTING STARTED

The Dwarf army is deployed for battle to take full advantage of its defensive capabilities. With solid units of Warriors and Ironbreakers to the fore and powerful artillery units in the rear, these stalwart soldiers can break even the most determined opponents.



This 80-page Army book contains painting and modeling guides, background, and the full rules for fielding an army of Dwarf warriors and their mighty war machines.

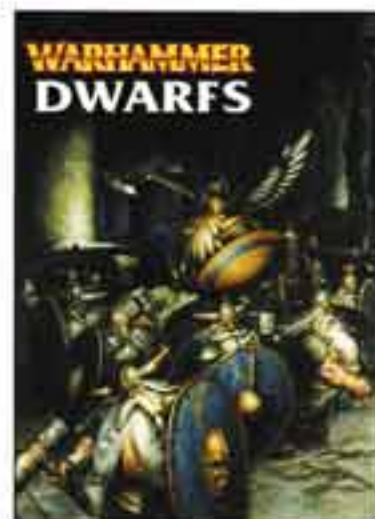

**Warhammer Armies
Dwarfs**
60030205001



**Dwarf Warriors
Regiment Box (16)**
99120205001

The Dwarf Regiment boxed set is a great place to start building your Dwarf army. Included in the box is everything you need to make any one of three different regiments: a Warrior regiment with hand weapons and shields, a Warrior regiment with great weapons, or a regiment of Crossbowmen. The box also includes a plastic command group with a Champion, Musician, and Standard Bearer.

Right: Dwarfs armed with crossbows.

Center Right: Warriors armed with hand weapons and shields.

Bottom Right: Warriors armed with great weapons.



LORDS & HEROES



DWARF LORD

WHITE DWARF

KING KAZADOR

UNGRIM IRONFIST

JOSEF BUGMAN

Dwarf Lord Blister (Random 1)
99060205070



DWARF LORD BODY
9947020507802



WHITE DWARF BODY
9947020501101



KING KAZADOR BODY
9947020500501



UNGRIM IRONFIST BODY
9947020500601



JOSEF BUGMAN BODY
9947020501001



KING KAZADOR BANNER POLE
9947020500503



DWARF LORD AXE
9947020507801



WHITE DWARF AXE
9947020501102



KING KAZADOR THUNDER HORN
9947020500502



DWARF ENGINEER 1
9947020508401



DWARF ENGINEER 2
9947020508402

Dwarf Engineer Blister (Random 1)
99060205084



JOSEF BUGMAN BANNER POLE
9947020501002



UNGRIM IRONFIST BANNER POLE
9947020500602



DWARF RUNESMITH
9947020501701

KRAGG THE GRIM

Dwarf Runesmith Blister (Random 1)
99060205017



KRAGG THE GRIM BODY
9947020500801



KRAGG THE GRIM BANNER POLE
9947020500802



KING ALRIK BODY
9947020508801



KING ALRIK'S AXE
9947020508802



**King Alrik Ranulfsson
of Karak-Hirn Box (1)**
99110205088



KING ALRIK'S SHIELD
9947020508806



**KING ALRIK'S
BOOK OF GRUDGES**
9947020508805



**KING ALRIK'S
SHILDBEARER 1**
9947020508803



**KING ALRIK'S
SHILDBEARER 2**
9947020508804



Garagrím Ironfist Blister (1)
99060205092

Garagrím has taken the ancient title of War-mourner, an old rank that was once used by the High King's champions. It is the duty of the War-mourner to act in the King's stead in battle and accept the King's honor as his own.



GARAGRIM IRONFIST BASE
9947020509204



**GARAGRIM IRONFIST
LEFT ARM**
9947020509202



GARAGRIM IRONFIST BODY
9947020509201



**GARAGRIM IRONFIST
RIGHT ARM**
9947020509203



LORDS & HEROES

PAINTING DWARF BEARDS



GREY BEARDS

1. Basecoat with Codex Grey.
2. Wash with Chaos Black and a small bit of Varnish to help break the surface tension.
3. Highlight with Codex Grey.
4. Highlight with Fortress Grey.



BLONDE BEARDS

1. Basecoat with Bubonic Brown.
2. Wash with Bestial Brown and a bit of Varnish to break the surface tension.
3. Highlight with Bubonic Brown.
4. Highlight with a mix Bubonic Brown and Skull White.
5. Continue to add Skull White to make the beard more blonde.



BROWN BEARDS

1. Basecoat with Scorched Brown.
2. Add Bleached Bone to Scorched Brown for the first highlight.
3. Continue to add increasing amounts of Bleached Bone for the subsequent highlights. These final highlights are best placed near the edges of the beard.



RED BEARDS

1. Basecoat with Dark Flesh.
2. Highlight with a 50/50 mix of Dark Flesh and Blood Red.
3. The next highlight is straight Blood Red in a few selected spots.
4. The final highlight is a very light amount of Blazing Orange.

LORDS & HEROES



**Thorek Ironbrow & the Anvil of Doom
Box (1 Anvil & 4 Crew)**
9911205073



**ANVIL OF DOOM
FORGE LEFT SIDE**
9947020507311



**ANVIL OF DOOM
FORGE RIGHT SIDE**
9947020507313



**ANVIL OF DOOM
CHIMNEY**
9947020507310



**ANVIL OF DOOM
FORGE & COALS**
9947020507312



Detail shot of the Anvil of Doom.



**RUNE PRIEST
THOREK IRONBROW**
9947020507316



**ANVIL OF DOOM
ANVIL PILLAR**
9947020507306



**ANVIL OF DOOM
BELLOWS**
9947020507309



ANVIL OF DOOM BANNER POLE
9947020507301



**THOREK'S
TONGS**
9947020507304



**THOREK'S
HAMMER**
9947020507315



ANVIL OF DOOM BASE
9947020507314



**ANVIL OF DOOM
APPRENTICE**
9947020507303



**APPRENTICE'S
TONGS**
9947020507302



**ANVIL OF DOOM
GUARDIAN SHIELD**
9947020507305



**ANVIL OF DOOM
GUARDIAN 1**
9947020507317



**ANVIL OF DOOM
GUARDIAN 2**
9947020507318



ANVIL OF DOOM FORGE HOOD
9947020507308



ANVIL OF DOOM ANVIL HEAD
9947020507307



The Dwarf Warrior boxed set includes bitz to create a Warrior regiment with hand weapons and shields, crossbows, or great weapons. The set also provides you with many different bitz to make your regiments unique.



CORE UNITS

Above: A Dwarf Warrior with a hand weapon and shield prepares for battle while he puffs away on his pipe.

Right: A Dwarf Crossbowman marches to the front lines while enjoying a cool draft of Bugman's Finest. The beer stein is just one of the many different bitz included in the Dwarf Warrior boxed set with which you can customize your army.



Dwarf Warriors Regiment Box (16)
99120205001

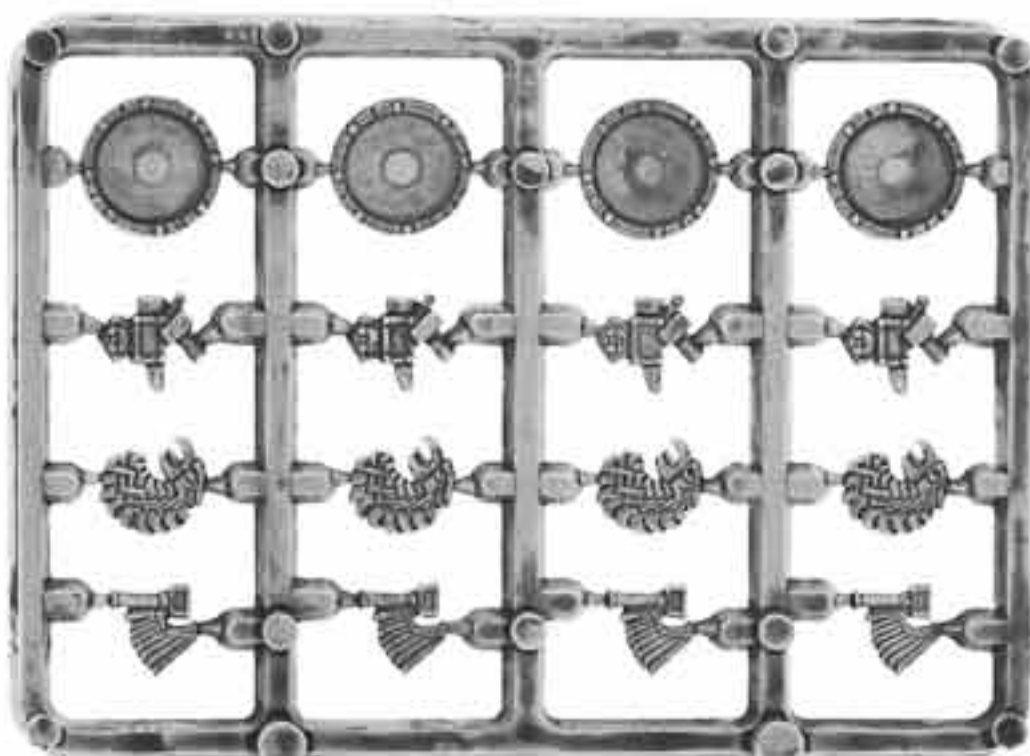

DWARF WARRIOR SHIELD SPRUE
99380299007

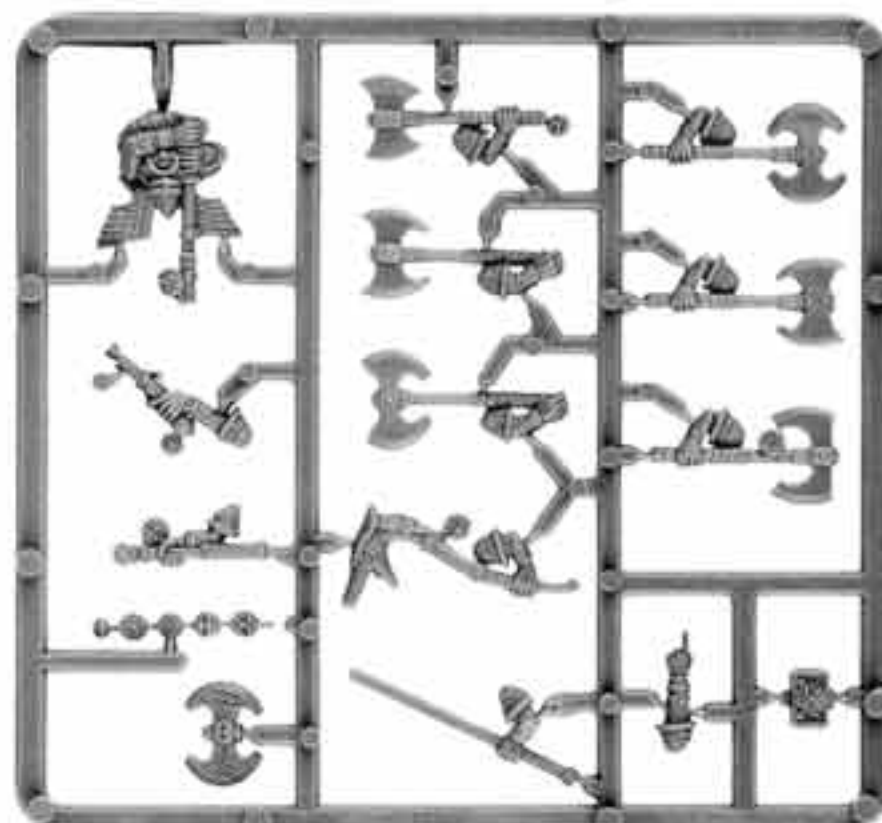

DWARF REGIMENT COMMAND SPRUE
(SHOWN 55% ACTUAL SIZE)
99380205002

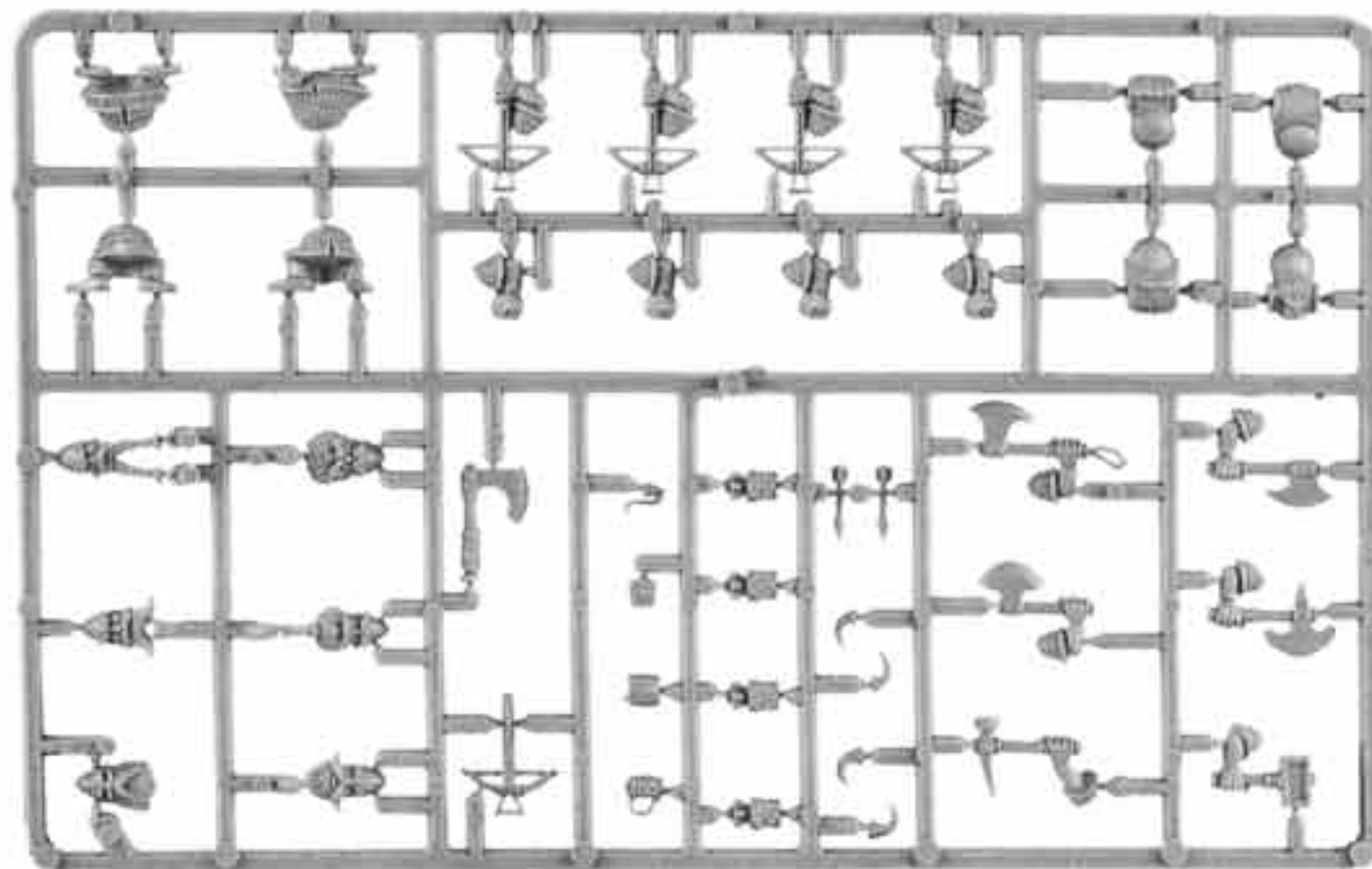

DWARF WARRIOR SPRUE (SHOWN 55% ACTUAL SIZE)
99380205001

CORE UNITS



Miner Regiment Box (10) & Miner Command Blister (3)
99110205031 99060205054



The Miner Command blister contains a Standard Bearer, Musician, and a random Miner Champion (99947020503203) or Miner Hero (994702050101).



MINER CHAMPION
9947020503803



MINER HERO
9947020501801



MINER STANDARD
9947020503201



DWARF MINER 1
9947020503101



DWARF MINER 2
9947020503102



DWARF MINER 3
9947020503103



DWARF MINER 4
9947020503104



DWARF MINER 5
9947020503105



MINER MUSICIAN
9947020503202



Rangers Regiment Box (10)
99110205079
Rangers Command Blister (3)
99060205080



RANGER CHAMPION
9947020503503



RANGER TROOPER 1
9947020503505



RANGER TROOPER 2
9947020503506



RANGER TROOPER 3
9947020503507



RANGER STANDARD
9947020508001



RANGER MUSICIAN
9947020508002



CORE UNITS



Thunderers Regiment Box (10) & Thunderers Command Blister (3)
99110205076 99060205077



THUNDERER STANDARD
9947020507703



THUNDERER STANDARD TOP
9947020507704



THUNDERER MUSICIAN
9947020507702



THUNDERER 1
9947020507601



THUNDERER 2
9947020507602



THUNDERER 3
9947020507603



THUNDERER 4
9947020507604



THUNDERER CHAMPION
9947020507701



Hammerers Regiment Box (10)
99110205015

Hammerers Command Blister (3)
99060205056



SPECIAL UNITS



HAMMERER STANDARD TOP
9947020501603



HAMMERER STANDARD
9947020501602



HAMMERER CHAMPION
9947020501601



HAMMERER MUSICIAN
9947020501604

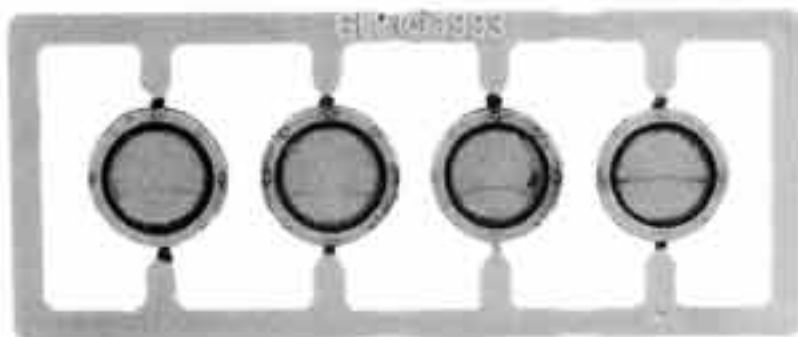

SMALL ROUND SHIELD SPRUE
99369999004



HAMMERER 1
9947020501501



HAMMERER 2
9947020501502



HAMMERER 3
9947020501503



HAMMERER 4
9947020501504

SPECIAL UNITS



Slayer Regiment Box (10) & Slayer Command Blister (3)
99110205025 99060205072

The Slayer Command blister contains a Standard Bearer, Musician, and a random Daemon Slayer 1 (9947020503056) or Dragon Slayer 1 (9947020502955).



**TROLL SLAYER
STANDARD**
9947020502101



**TROLL SLAYER
STANDARD TOP 2**
9947020507201



DAEMON SLAYER 1
9947020503056



DRAGON SLAYER 1
9947020502955



**TROLL SLAYER
MUSICIAN**
9947020502103



SLAYER 1
9947020502854



SLAYER 2
9947020502601



SLAYER 3
9947020502653



SLAYER 4
9947020502602



SLAYER 5
9947020502603

SLAYER TATTOOS

After you complete the painting on your Slayer model, it's time to add his tattoos. Tattoos can be anything – ferocious monsters, swirls, runes, and more. The only limit is your imagination.



STEP 1

Thin down some Chaos Black and use it to paint the tattoo carefully on his skin with a fine detail brush.



STEP 2

Fill the tattoo in with Ultramarines Blue. Take care to leave a black line around the edge. Note – if you don't want a black line border, skip Step 1 and start here.



STEP 3

Carefully add a few thin lines of Ice Blue for the highlights on the tattoos.

SPECIAL UNITS



Slayer Doomseekers Blister (Random 2)
99060205093

Doomseekers, whirling their weapons madly around their heads, plow recklessly into the enemy.



SLAYER DOOMSEEKER AXE 1
9947020509305



SLAYER DOOMSEEKER AXE 2
9947020509306



SLAYER DOOMSEEKER BODY 1
9947020509301



SLAYER DOOMSEEKER BODY 2
9947020509302



SLAYER DOOMSEEKER BODY 3
9947020509303



SLAYER DOOMSEEKER BODY 4
9947020509304



SLAYER DOOMSEEKER AXE 3
9947020509307



SLAYER DOOMSEEKER AXE 4
9947020509308

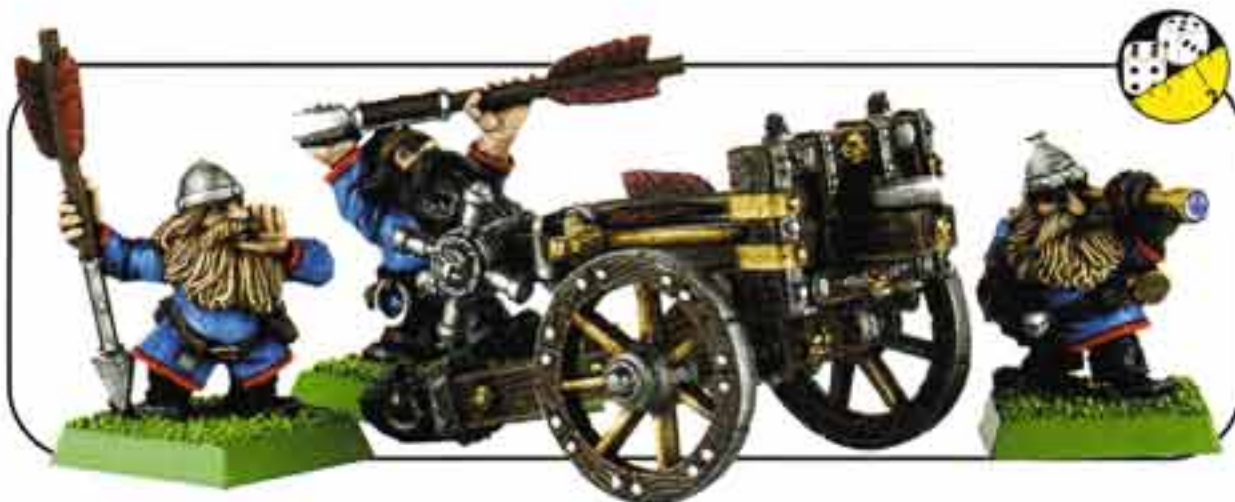

Bolt Thrower Blister (1 Bolt Thrower & 3 Crew)
99060205042

The Bolt Thrower comes with the Cannon Handle (9947020501404) shown with the Cannon.



BOLT THROWER CARRIAGE
9947020504204



BOLT THROWER FRONT FRAME
9947020504206



BOLT THROWER BOW
9947020504205



BOLT THROWER CREW 1
9947020504201



BOLT THROWER CREW 2
9947020504202



BOLT THROWER CREW 3
9947020504203



BOLT THROWER BOLT
9947020504207

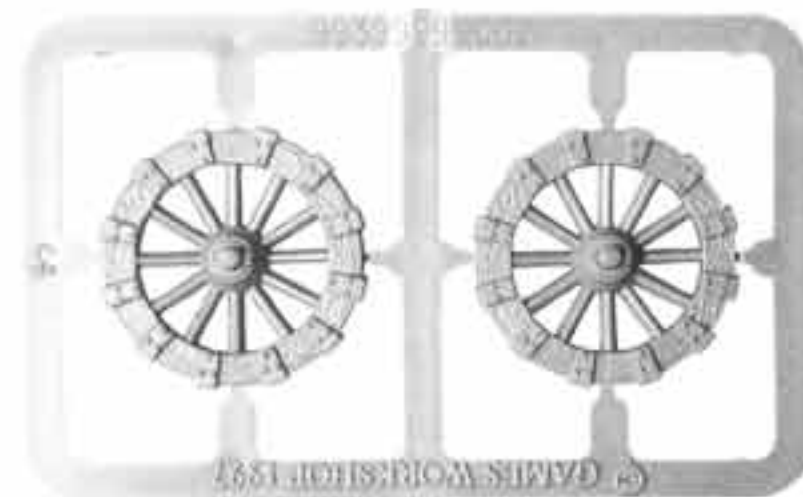

12-SPOKE WHEEL SPRUE
99399999002

SPECIAL UNITS



SOLID WAGON WHEEL SPRUE
99399999058

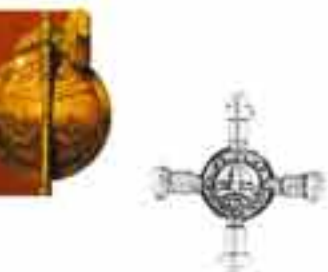

CANNON HANDLE
9947020501404



CANNON CHASSIS
9947020501405



Dwarf Cannon Blister (1 Cannon & 3 Crew)
99060205014



CANNON BARREL
9947020501406



CANNON CREW 1
9947020501403



CANNON CREW 2
9947020501402



CANNON CREW 3
9947020501401

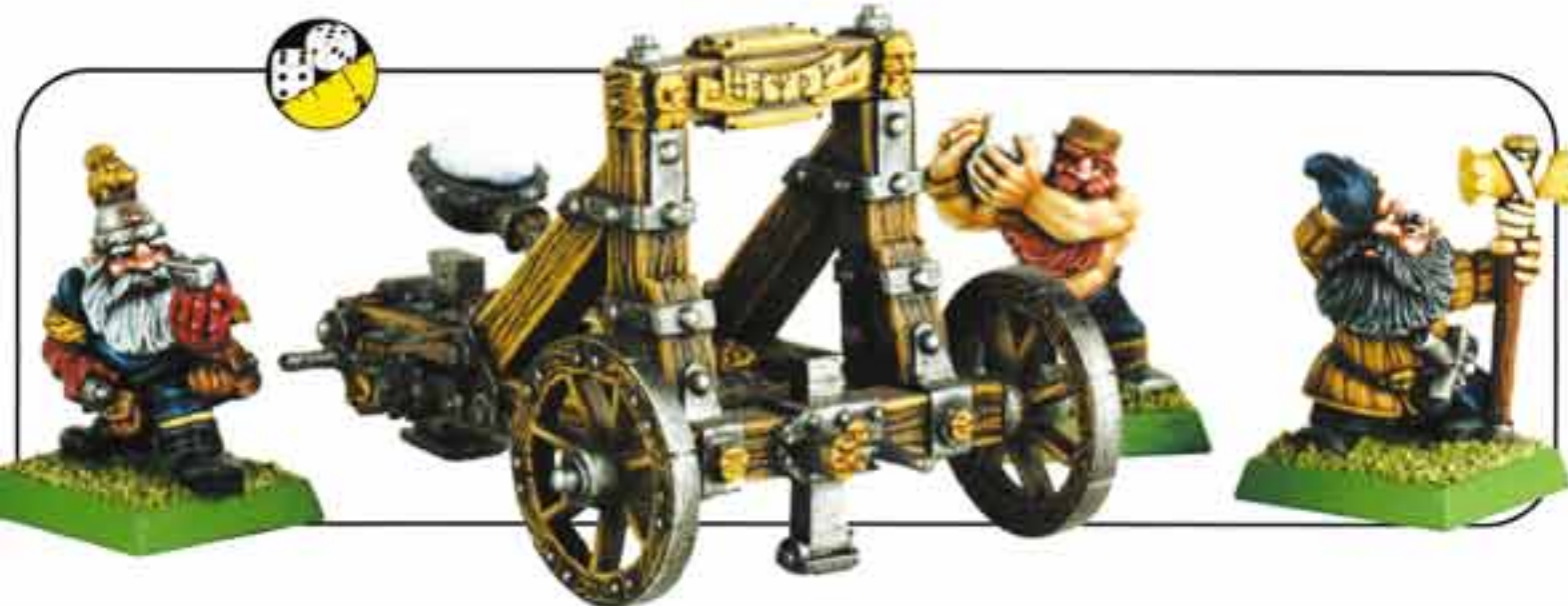

Stone Thrower Blister (1 Stone Thrower & 3 Crew)
99060205044

The Stone Thrower comes with the 12-Spoke Wheel Sprue (99399999002) shown with the Bolt Thrower.



STONE THROWER RIGHT FRAME
9947020504404

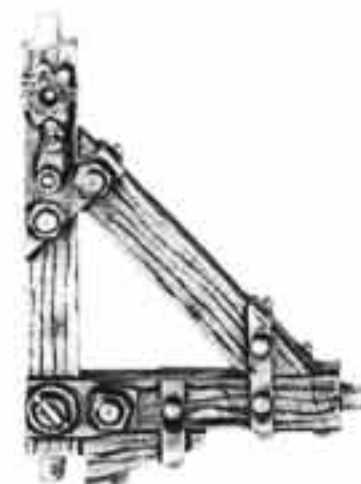

STONE THROWER LEFT FRAME
9947020504405



STONE THROWER GUNNER
9947020504401



STONE THROWER LOADER 1
9947020504402



STONE THROWER LOADER 2
9947020504403



STONE THROWER WINCH
9947020504411



STONE THROWER FRONT ELEVATOR
9947020504410



STONE THROWER WINCH HANDLE
9947020504412



STONE THROWER ARM REST
9947020504406



STONE THROWER FRONT CROSSPIECE
9947020504407

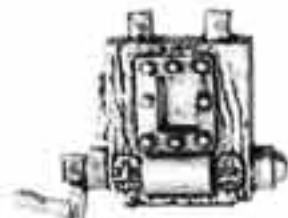

STONE THROWER ELEVATOR CRANK
9947020504408



STONE THROWER ELEVATION SCREW
9947020504413



STONE THROWER THROWING ARM
9947020504409

SPECIAL UNITS



Ironbreaker Regiment Box (10) & Ironbreaker Command Blister (3)
 99110205081 99060205082



IRONBREAKER STANDARD
 9947020508204



IRONBREAKER MUSICIAN
 9947020508203



IRONBREAKER 1
 9947020508101



IRONBREAKER 2
 9947020508102



IRONBREAKER 3
 9947020508103



IRONBREAKER 4
 9947020508104



IRONBREAKER SHIELD
 9947020508105



IRONBREAKER CHAMPION ARM
 9947020508201



IRONBREAKER CHAMPION
 9947020508202



Longbeard Regiment Box (10) & Longbeard Command Blister (3)
 99110205074 99060205075

Longbeards come with the Dwarf Warrior Shield Sprue (99360299007) shown with the Dwarf Warriors.



LONGBEARD STANDARD TOP
 9947020507504



LONGBEARD 1
 9947020507401



LONGBEARD 2
 9947020507402



LONGBEARD 3
 9947020507403



LONGBEARD 4
 9947020507404



LONGBEARD CHAMPION
 9947020507501



LONGBEARD MUSICIAN
 9947020507502



LONGBEARD STANDARD
 9947020507503

RARE UNITS



Gyrocopter Box (1)
99110205083



GYROCOPTER CONTROL STICK
9947020508305



GYROCOPTER SKIDS
9947020508301



GYROCOPTER ROTOR A
9947020508303



GYROCOPTER ROTOR B
9947020508306



GYROCOPTER ENGINE
9947020508309

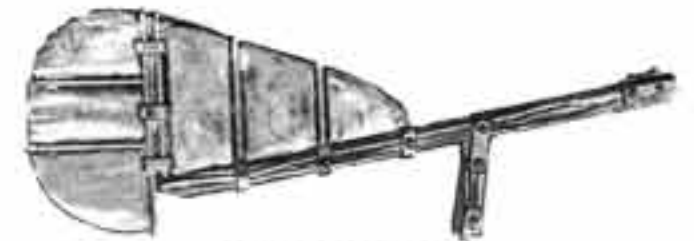

GYROCOPTER TAIL
9947020508308



GYROCOPTER CAB
9947020508302



GYROCOPTER PILOT
9947020508304



GYROCOPTER PILOT ARM
9947020508307



GYROCOPTER GUBBINS SPRUE
9947020508310

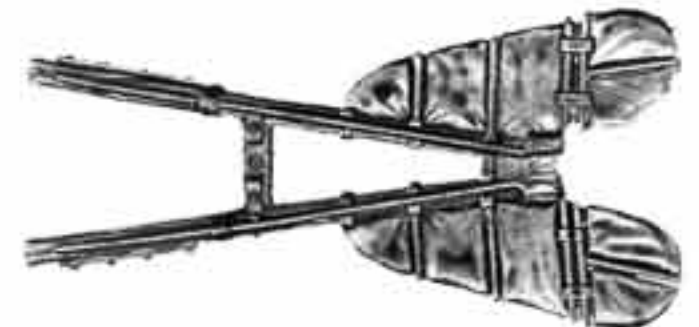

GYROCOPTER CHASSIS
9947020508311



Organ Gun Blister (1 Organ Gun & 3 Crew)
99060205041

The Organ Gun comes with the 12-Spoke Wheel Sprue (99399999002) shown with the Bolt Thrower in Special Units.



ORGAN GUN LEVER
9947020504109



ORGAN GUN COUPLING
9947020504108



ORGAN GUN CARRIAGE
9947020504106



ORGAN GUN CREW 1
9947020504101



ORGAN GUN CREW 2
9947020504102



ORGAN GUN CREW 3
9947020504103

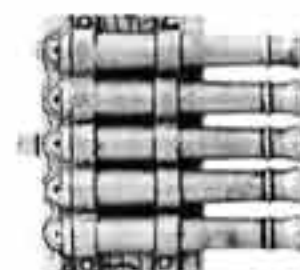

ORGAN GUN BARRELS
9947020504104



ORGAN GUN FRONT PANEL
9947020504105



ORGAN GUN AXLE
9947020504107



The Flame Cannon comes with the Solid Wagon Wheel Sprue (99399999058) shown with the Cannon in Special Units.



Flame Cannon Box (1 Flame Cannon & 3 Crew)
99110205087



FLAME CANNON SPOTTER
9947020508707



FLAME CANNON GUNNER
9947020508708



FLAME CANNON LOADER
9947020508709



FLAME CANNON BREACH HATCH
9947020508704



FLAME CANNON GUBBINS
9947020508705

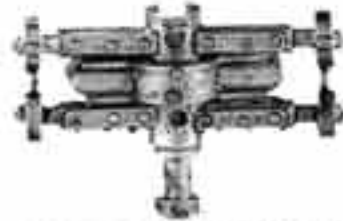

FLAME CANNON CHASSIS
9947020508701



FLAME CANNON VALVE SPRUE
9947020508706



FLAME CANNON FUEL TANKS
9947020508702

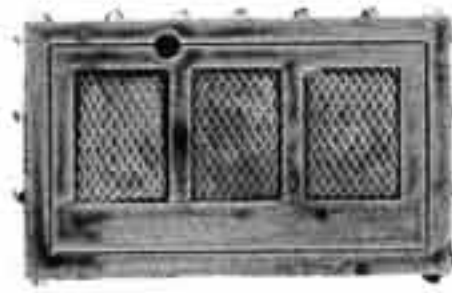

FLAME CANNON PANEL
9947020508710



FLAME CANNON BARRELS
9947020508703



FLAME CANNON LEFT SIDE
9947020508711



FLAME CANNON RIGHT SIDE
9947020508712



RARE UNITS

PAINTING DWARF RUNES

Painting runes on Dwarf war machines can add a level of extra detail that makes the models stand out from other war machines on the table. Following are a few instructions on how to paint runes.



STEP 1

After painting the war machine, choose a large, reasonably flat area where it will be easy to paint the fine details of the rune. Select the rune that you want to paint from *Warhammer Armies: Dwarfs*. Paint the rune design in Chaos Black. Paint wide, almost exaggerated lines so that they can be easily painted over in the following steps.



STEP 2

For the next step, use a color of medium brightness such as Ultramarines Blue and trace the inside of the rune. Leave a bit of black on the outside of the rune to give it a bit of depth and make it stand out on the war machine.



STEP 3

Use a bright metal color such as Burnished Gold or Mithril Silver (Burnished Gold was used here). Apply a thin line through the center of the second color. This step makes your rune stand out from the rest of the machine and easier to see. Choose a color that contrasts with the metal of the machine. Since the barrel of this Cannon is a grey metallic color, bright gold was used to accent the rune.

RARE UNITS



GOBLIN HEWER LEFT ARM
9947020509107



GOBLIN HEWER RIGHT ARM
9947020509108



Malakai Makaiisson's Goblin Hearer Blister (1)
99110205091



MALAKAI MAKAIISSON
9947020509101



GOBLIN HEWER CREW 1
9947020509102



GOBLIN HEWER CREW 2
9947020509103



GOBLIN HEWER DEAD GOBLIN
9947020509104



GOBLIN HEWER BASE
9947020509114

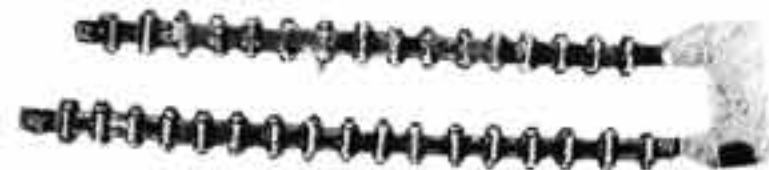

GOBLIN HEWER CHAINS
9947020509111

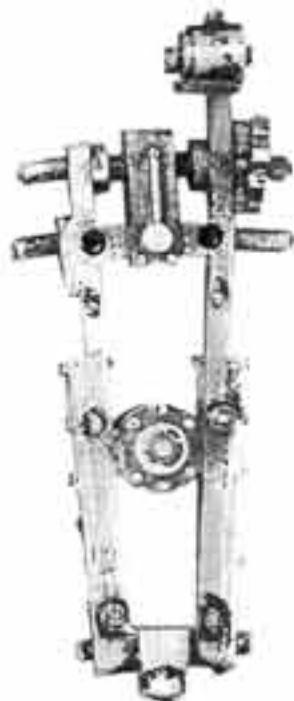

GOBLIN HEWER LOWER CHASSIS
9947020509112



GOBLIN HEWER UPPER CHASSIS
9947020509113



GOBLIN HEWER AXE
9947020509109



GOBLIN HEWER HEAD
9947020509115



GOBLIN HEWER AXE RACK
9947020509117

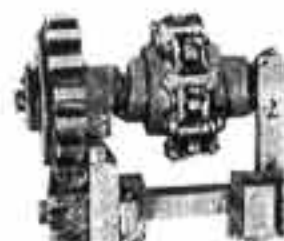

GOBLIN HEWER MOTOR
9947020509110



GOBLIN HEWER SPRUE
9947020509116

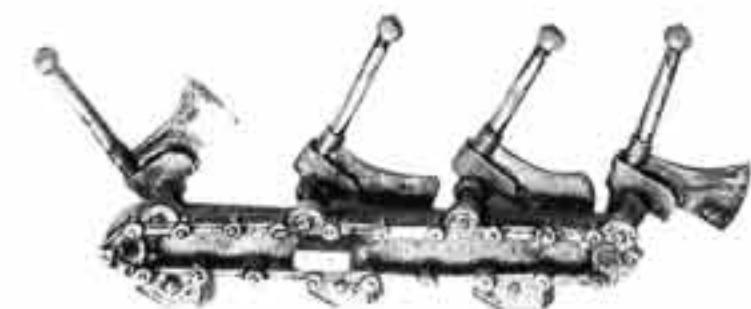

GOBLIN HEWER RIGHT SIDE
9947020509106

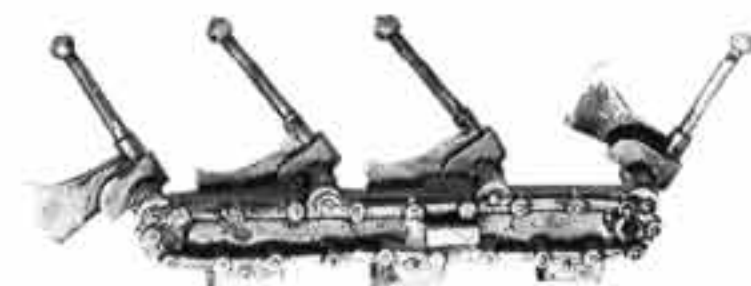

GOBLIN HEWER LEFT SIDE
9947020509105



TACTICS

TIPS FOR WINNING WITH DWARFS



- A. Dwarfs have top-notch missile troops and artillery in spades. Dwarf Thunderers are some of the best missile troops in the game. They are excellent at short range and are just as good as Dwarf Warriors in combat. The use of runes can make unpredictable war machines a lot more reliable and deadly. Don't be afraid to load up on this stuff!
- B. Dwarf units tend to be small and thus can be vulnerable to large units of *Fear*-causing Undead. To combat them, stock up on runes and field Troll Slayers. Also, a few Runic Standards can negate the advantage of *Fear*. You can use the Master Rune of Fear (75 points). Also, the Rune of Courage makes a unit *Immune to Psychology* for 50 points. You can also use the same rune on a second banner along with the Rune of Battle (+1 to combat resolution for 25 points). Having two Standards with the Rune of Courage is allowed as long as one of them has a second Rune.
- C. The proper combination of runes can make a Dwarf Lord a very powerful opponent. Few other Lord-level characters can dish out or take as much damage, and you can find several runic combinations that can add a bewildering array of versatility to your Lord over several battles.



COUNTERTACTICS

TIPS FOR FIGHTING AGAINST DWARFS

- A. Dwarfs are slow and expensive and have neither great magic nor cavalry. Exploit these disadvantages as much as possible! Take fast-moving units to outmaneuver the Dwarfs, outnumber them, and fry them with spells. If you have a regular Dwarf opponent, notice his patterns and come up with effective counters. If he never fields Runesmiths, it's magic time! If he deploys poorly, use lots of cheap fast troops to get the flank bonus and negate ranks. If he takes few war machines, take missile troops to shoot the Dwarfs to death.
- B. You will almost always get the charge against a Dwarf army, so make it count. Stack a unit of cavalry with a few heavily armed characters and head for the weak side (avoid Troll Slayers!) of the Dwarf line. With average rolling (and maybe an accompanying unit charging in the front) you should rout the unit, destroy them in the pursuit (Dwarfs roll 2D6-1 to determine flee distance), and slam into the next Dwarf unit. Dwarfs are slow to react – so lather, rinse, and repeat!
- C. Dwarf players will often overinvest in their Lord-level characters. While such characters can be very powerful in hand-to-hand combat, they are also slow to maneuver and thus very easy to avoid. If you suspect (or, even better, can use magic items to ascertain for certain) that a Dwarf Lord or Hero is loaded with runes, avoid him like the plague and pick on the more vulnerable units instead.



COLORS OF WAR



KEY

■ Top Box(es): Basecoat Colors & Ink Washes

■ Bottom Box(es): Highlights

■ Mixed Colors



Regal Blue, Fortress Grey
Enchanted Blue, Skull White



Midnight Blue, Snakebite Leather
Ultramarine Blue, Bleached Bone



Scab Red, Fortress Grey
Blood Red, Skull White



Dark Angels Green, Bubonic Brown
Goblin Green, Bleached Bone



Regal Blue, Red Gore
Enchanted Blue, Blood Red



Scorched Brown, Snot Green
Bubonic Brown, Scorpion Green



Regal Blue, Dwarf Bronze
Enchanted Blue, Burnished Gold



Bubonic Brown, Tin Bitz
Bleached Bone, Brazen Brass



Red Gore, Bestial Brown
Blood Red, Bubonic Brown



Boltgun Metal, Tin Bitz
Chainmail, Brazen Brass



Red Gore, Chaos Black
Blood Red, Scorpion Green



Shining Gold, Goblin Green
Burnished Gold, Scorpion Green



Bubonic Brown
Bubonic Brown &
Bleached Bone

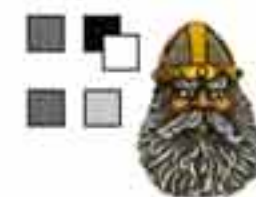

Codex Grey,
Chaos Black & Varnish
Codex Grey, Fortress Grey



Scorched Brown
Bestial Brown &
Bleached Bone



Dark Angels Green, Boltgun Metal
Goblin Green, Mithril Silver



Regal Blue, Fortress Grey
Enchanted Blue, Skull White



Codex Grey
Skull White



Vomit Brown
Vomit Brown &
Bleached Bone



Chaos Black
Fortress Grey



Golden Yellow
Bad Moon Yellow



Shining Gold, Chestnut Ink
Burnished Gold, Skull White



Regal Blue, Blood Red
Enchanted Blue, Blazing Orange



Dark Flesh
Dark Flesh & Blood
Red, Blazing Orange

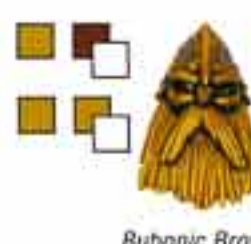

Bubonic Brown,
Bestial Brown & Varnish
Bubonic Brown,
Bubonic Brown & Skull White



Scorched Brown
Scorched Brown &
Bleached Bone



Scorched Brown
Scorched Brown &
Bubonic Brown

ALTERNATE MODEL – LORDS & HEROES
Dwarf Engineer

COMPONENTS FOR 1 COMPLETE MODEL

- 9947020500702 Burlock Damminson Pack
- 9947020508708 Flame Cannon Gunner
- 9947110500212 Dwarf Weapon Sprue 3

COMPLEXITY RATING



**THIS CONVERSION
 CONTAINS THE SPECIAL
 OFFER BITZ SHOWN HERE**

*See the catalog introduction
 for more information.*

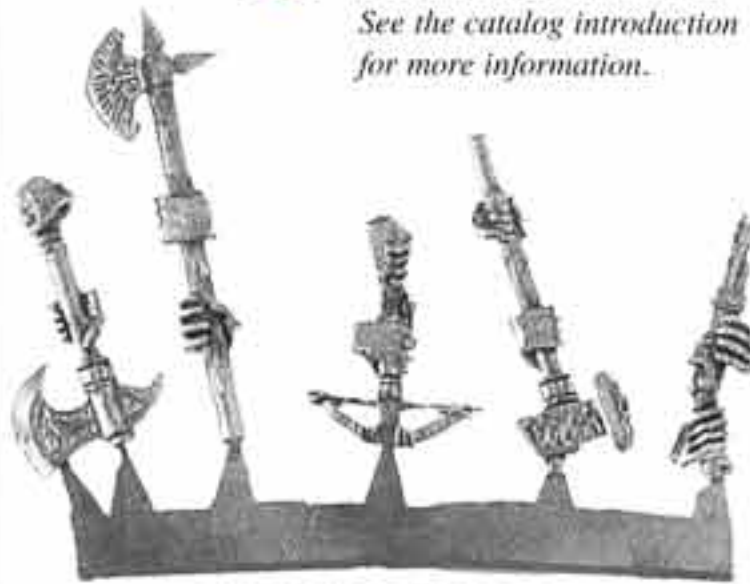

DWARF WEAPON SPRUE 3
 9947110500212



SHOWCASE

ALTERNATE MODEL – CORE UNITS
Dwarf Rangers

COMPONENTS FOR 4 COMPLETE MODELS

- 99380201011 Marauder Sprue B
- 99380203004 Bretonnian Foot Comm. Sp.
- 99380205001 Dwarf Warrior Sprue
- 99380205002 Dwarf Command Sprue
- 99380299007 Dwarf Shield Sprue
- 99381102002 Middenheimer Sprue
- 99391199001 Mordheim Acc'y. Sprue (x2)

COMPLEXITY RATING



*Below: Doug Braun's Giant Slayers versus
 Giant won first place in the Battle Scene
 category at the 2004 Chicago Games Day
 Golden Demon Painting Competition.*



*Below Right: Dwarf King Durek Anvilpants, made by
 Jeremy Vetoek, one of our Key Games Designers.*



*Below: Gary Taylor won second
 place at the 1996 UK Golden
 Demon Painting Competition*

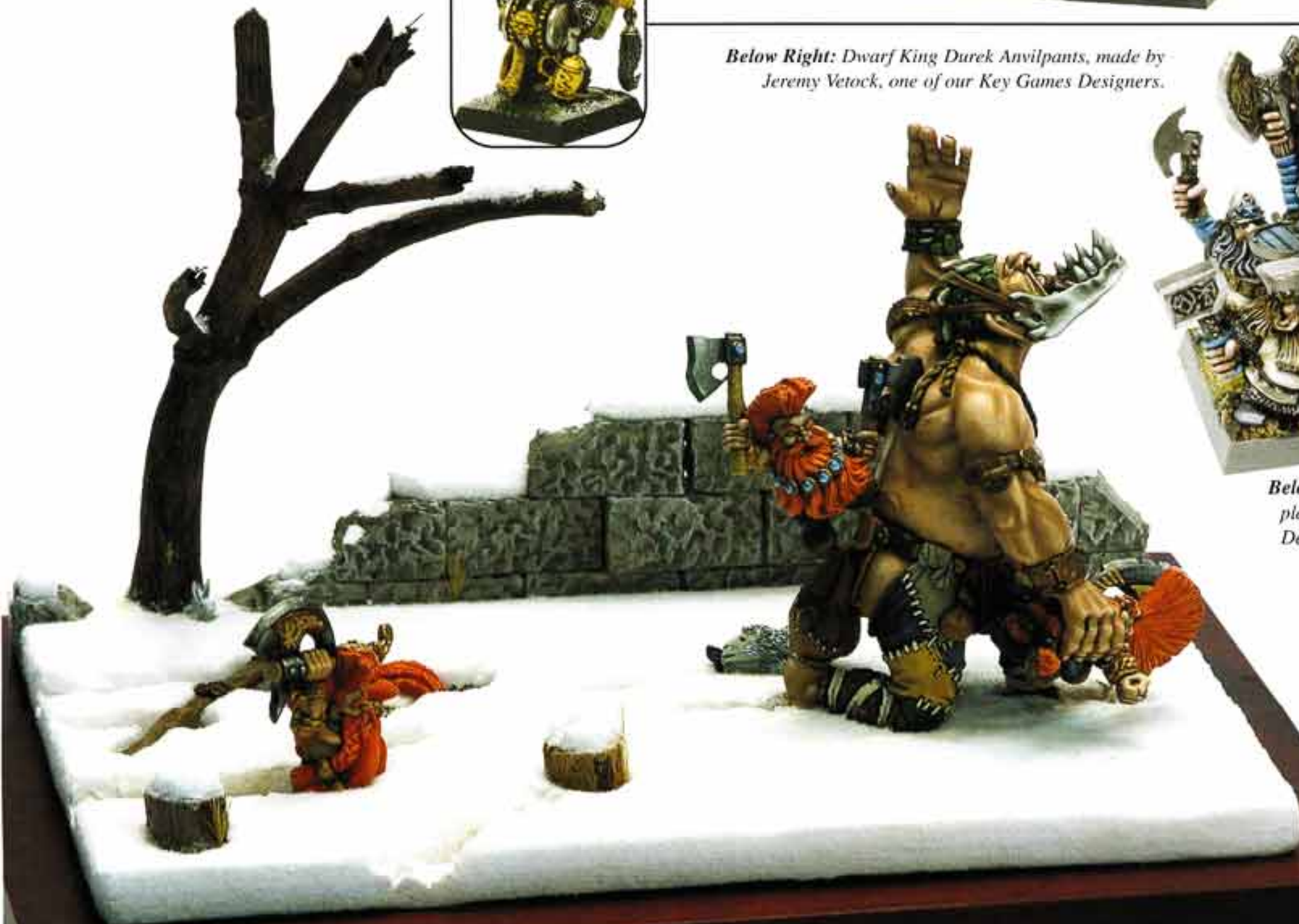

THE EMPIRE

Master Engineer Gunther Hoffman tensed his grip on the telescope and resisted the urge to rap the youngest member of the cannon crew on the head. Instead, the Engineer attempted to put that energy to good use. "Why, young Heinrich, have I not bludgeoned you with my telescope for not loading the Great Cannon correctly?" asked Gunther sternly.

Heinrich pulled himself off the ground, where he had thrown himself after the gunpowder flash, and attempted to wipe his blackened face with his cap.

The instructor leaned forward fruitlessly in anticipation of an answer.

"Because..." Gunther suggested, hopelessly staring at the vapid young trainee.

After a painfully long moment, the Engineer answered his own question.

"Because it is a finely tuned instrument and must be handled with respect!"

Gunther continued to stare down at the youngster and said, "You swab the barrel first, then load. Swab, then load. As you and the rest of the crew clean out the outhouses and stables, I think you should repeat that to yourselves."

With that last command, Gunther signaled for the rest of the class to gather around. "This may be an Artillery School, and this may be a class, but some day, this training is going to save your life and maybe the whole of the Empire. Now repeat after me the loading procedures from the beginning."

The Empire is the largest and most powerful realm of Men in the Warhammer world. It is a sprawling domain that encompasses great mountains, mighty rivers, and vast cities. Its citizens and soldiers are as different and varied as the governing city-states and provinces that make up the Empire.

Fighting Style

Empire armies cannot match the numbers of a horde army like Skaven or Orcs & Goblins, nor can they match the hardened elites of a Chaos army or High Elf force. Instead, Empire Generals must rely on the same attributes that carved out such a large realm in the first place: infantry, cavalry, and artillery all used in a coordinated fashion.



Above: Mike Anderson made this First Knight of the Teutogen Guard for the 2004 Storm of Chaos campaign.

Right: Mark Tait's Luthor Huss won third place at the 2003 UK Games Day Golden Demon Painting Competition.



War machines can thin down a horde, reduce enemy elites, or blast gaping holes into a monster of any size. Infantry can hold up enemy elites, while smaller units use the special *Detachments* rule to countercharge and take the foe on several sides. Cavalry charges are reserved for particularly hardened foes, striking the killing blow, or devastating flank charges. A veteran Empire general will quickly analyze the threat against his forces and countermove to put his troops in the best position to win. Sometimes, this process involves playing defensively and shooting up enemy advances; sometimes, it means closing quickly with the foe and overwhelming him with multiple units. Knowing the strengths and weaknesses of your army and your opponent's force as well as using terrain to maximum advantage are what will bring further glory to the Empire.

Collecting an Empire Army

Core troops are the best place to begin when starting any army, and for Empire, that means a lot of choices. Blocks of infantry like Halberdiers, Spearmen, or Swordsmen can form an ideal center. Archers, Handgunners, and Crossbowmen will make useful Detachments to thin down the enemy. Free Companies are a low-points way to bulk out a force and, when used as a Detachment, can offer valuable support to better equipped units. The hard-striking and well-armed

might of the Knightly Orders may also be selected as a Core unit, although Knights are sure to draw an inordinate amount of the enemy's firepower and wrath.

When expanding to a larger Empire force, players have a plethora of fantastic choices. Greatswords add more punch than regular infantry, and Pistoliers are a *Fast Cavalry* option that can easily slow down or outflank a foe. Flagellants are angst-ridden prophets of impending doom, but their *Crazed* presence can easily hold and secure a flank. Empire war machines deserve special mention, as few things strike fear into an enemy the way a Helblaster Volley Gun does. The mere presence of a Volley Gun on the battlefield can cause the enemy endless worry and concern. Also, don't discount the fearsome barrage of a Mortar or the awesome killing power (D6 Wounds!) of the Great Cannon. Units may be augmented with characters like Warrior Priests, Engineers, or Wizards from the esteemed Colleges of Magic.

The Empire is constantly threatened by border wars, marauding Orcs, and the dread of Chaos to the north. Bandits and Beasts of Chaos dwell in the dark forests, and a new threat is always looming. Still, the Empire stands tall as a beacon of strength for the forces of civilization.



GETTING STARTED



This 80-page rulebook contains background, painting and modeling tips, and complete rules for fielding an army of the mighty human legions that make up the Empire. All praise Sigmar!

**Warhammer Armies:
Empire**
60030202001



LORDS & HEROES





Empire Battalion Box – 99120202007

- 1 General
- 12 Knights
- 20 Soldiers
- 12 Militia
- 1 Cannon/Mortar



Balthasar Gelt, the Supreme Patriarch Blister (1)
99060202112



BALTHASAR GELT BODY
9947020211201



PEGASUS HEAD
9947020211202



PEGASUS BODY RIGHT SIDE
9947020211203



PEGASUS BODY LEFT SIDE
9947020211205



STAFF OF VOLANS
9947020211204



PEGASUS LEFT WING
9947020211206



PEGASUS RIGHT WING
9947020211207

LORDS & HEROES



Valten, Champion of Sigmar Blister (1)
99060202120
BIT NAME: VALTEN
BIT CODE: 9947020212001



Valten, Chosen of Sigmar Blister (1)
99060202131



MOUNTED VALTEN BODY
9947020213101



MOUNTED VALTEN HAMMER
9947020213102



MOUNTED VALTEN TAIL/LEG SPRUE
9947020213103



ARMORED HORSE BODY & HEAD SPRUE
(RANDOM 1, SHOWN 80% ACT. SIZE)
99380299004



Valten, Exalted of Sigmar Box (1)
99110202199



VALTEN UPPER BODY
9947020219901



VALTEN TAIL/HAMMER SPRUE
9947020219902



ALTHANDIN HEAD
9947020219903



ALTHANDIN LEFT SIDE
9947020219904



ALTHANDIN RIGHT SIDE
9947020219905

All miniatures are supplied unpainted. Models, bits, and sprues are all shown actual size unless otherwise noted. Contents may vary slightly from those shown.



LORDS & HEROES



Karl Franz on Griffon Box (1)
99110202130



KARL FRANZ BODY
9947020213001



KARL FRANZ WEAPON SPRUE
9947020213002



EMPEROR BANNER POLE
9947020204402



GRIFFON RIGHT BODY SIDE
9947021000205



GRIFFON RIGHT CLAW
9947021000206



GRIFFON TAIL
9947021000208



GRIFFON LEFT CLAW
9947021000207



GRIFFON LEFT BODY SIDE 2
9947020204403



GRIFFON LEFT WING 1
9947020300111



GRIFFON RIGHT WING 1
9947020300112

DETAILING YOUR MODELS WITH EMBLEMS

Here are two examples of emblems you can use on barding, shields, banners, or anywhere else on your models. You can also try these techniques with emblems of your own design!

FLAMING COMET SKULL EMBLEM



Step 1. For a flaming comet skull emblem, start by cutting a plastic skull in half and gluing it in place. We tinted the skull red for visibility.



Step 2. Paint the surrounding area as normal and then paint the skull with Vomit Brown. Paint two wavy lines for the comet tails.



Step 3. Highlight the skull with Bleached Bone and fill the comet tails in to look like flames. Use the background color to fix any mistakes.



Step 4. Highlight the skull with Skull White and fill the flames in with a mix of Blazing Orange and Sunburst Yellow. Add details as desired.

BLAZING SUN EMBLEM

Step 1. After painting the shield Chaos Black, paint a circle and white lines with thinned Skull White.

Step 2. Starting at the tips, widen the lines with Skull White until they become rays. Paint in small wavy rays between the larger ones.

Step 3. Paint all of the white areas with Golden Yellow. Fill in any mistakes such as overlapping or jagged lines with Chaos Black.

Step 4. Highlight the rays and sun with a mix of Golden Yellow and Skull White. Continue to add Skull White for successive highlights until you're happy with the results.



LORDS & HEROES



Luthor Huss, Prophet of Sigmar Blister (1)
99060202115



LUTHOR'S BOOK
9947020211503



LUTHOR'S HORSE HEAD
9947020211504



LUTHOR HUSS BODY
9947020211501



LUTHOR'S HAMMER
9947020211502



Ar-Ulric Emil Valgeir Blister (1)
99060202201



AR-ULRIC BODY
9947020220102



AR-ULRIC SPRUE
9947020220104



Luthor Huss and the Warrior Priests of Ulric both include the Armored Horse Body & Head Sprue (99380299004) shown with Valten.

MOUNTED WARRIOR PRIEST OF ULRIC

WARRIOR PRIEST OF ULRIC
9947020211901

Warrior Priest of Ulric Blister (1 Mounted & 1 on Foot)
99060202119



MOUNTED WARRIOR PRIEST OF ULRIC BODY
9947020211902



AR-ULRIC AXE
9947020220101



AR-ULRIC STAFF
9947020220103



WARRIOR PRIEST 1

WARRIOR PRIEST 2

WARRIOR PRIEST 3
9947020210405

Warrior Priest Blister (Random 1)
99060202104



WARRIOR PRIEST 1 BODY
9947020210401



WARRIOR PRIEST 2 BODY
9947020210403



WARRIOR PRIEST 1 SHIELD
9947020210402



WARRIOR PRIEST 2 HAMMER
9947020210404



LORDS & HEROES



MOUNTED WIZARD 1 ARM
9947020210802



WIZARD 1
9947020210803



MOUNTED WIZARD 1 BODY
9947020210801



CAPARISON HORSE HEAD SPRUE (RANDOM 1)
99389999012



WIZARD 2
9947020210805



MOUNTED WIZARD 2 BODY
9947020210804

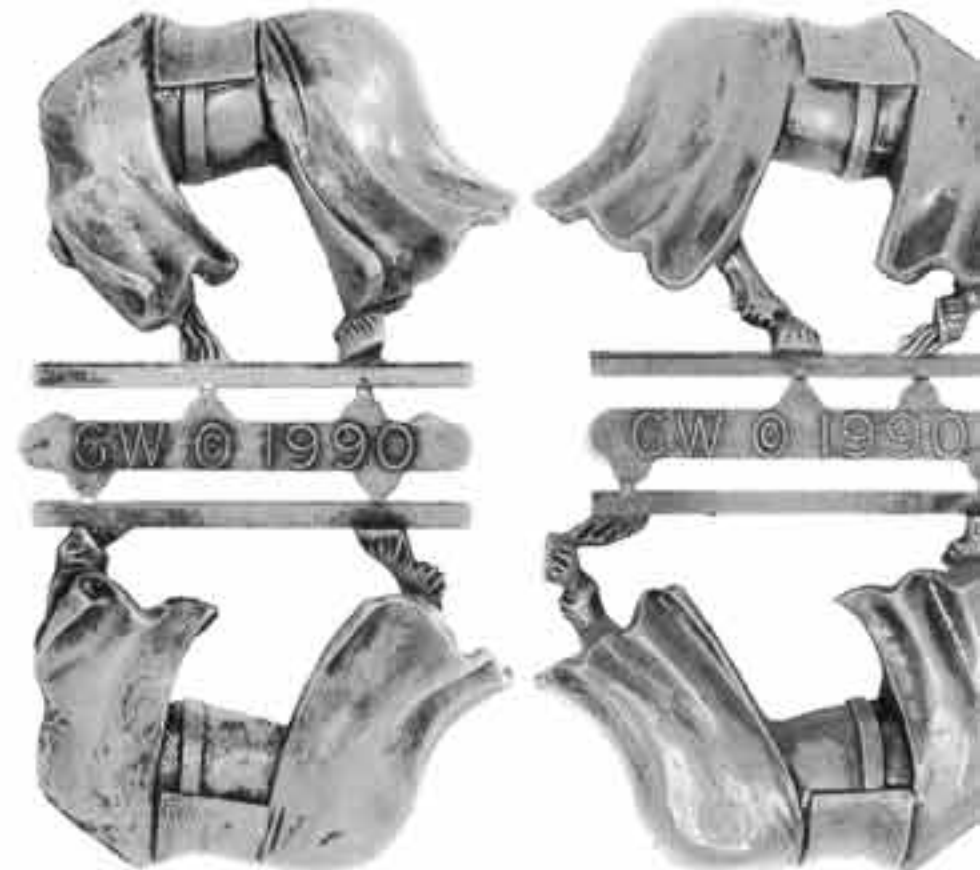

CAPARISON HORSE BODY SPRUE (RANDOM 1)
99389999002



Battle Wizards Blister (Random Matched Set of 1 Mounted & 1 on Foot)
99060202108



MOUNTED WIZARD 3 BODY
9947020210807



WIZARD 3 ARM
9947020210806



WIZARD 3
9947020210808

LORDS & HEROES

PAINTING HORSE BARDING

Horse barding can be painted in a variety of colors. Here are two examples (metallic and golden) to get you started.

METALLIC

After priming black, paint all metal areas with Boltgun Metal and wash with thinned Black Ink.



After the previous step is dry, highlight the edges with Boltgun Metal followed by Chainmail and finally Mithril Silver on the highest areas.



GOLDEN

Basecoat the metal areas with Vomit Brown.



Highlight the armor by painting layers with increasing amounts of Skull White added to the Vomit Brown. In this case, we've done about seven to eight layers and applied a final small highlight of Skull White to the edges. You can stop at this point. However, if you want a richer golden color,

move on to the step described below.

Glaze the armor with a mix of Yellow Ink and Flesh Wash. To apply a glaze, mix the two colors together with water to get a golden mixture. Dip your brush in the mixture and set the end of the brush on a paper towel or other absorbent material to draw off the excess

moisture. Drag the brush lightly over the armor rather than saturating the area as you would when applying an ink wash.



Templar Grand Master Blister (Random 1)
99060202110



**BLAZING SUN KNIGHT
GRAND MASTER BODY**
9947020200304



**KNIGHT PANTHER
GRAND MASTER BODY**
9947020202505



**WHITE WOLF KNIGHT
GRAND MASTER BODY**
9947020201006

The Templar Grand Master includes the Armored Horse Body & Head Sprue (99380299004) shown with Valten.



FIGHTER SHIELD SPRUE
99369999003



EMPIRE ENGINEER 1
9947020210701



EMPIRE ENGINEER 2
9947020210702



EMPIRE ENGINEER 3
9947020210703

Master Engineer Blister (Random 1)
99060202107

LORDS & HEROES



Elector Count Blister (Random 1)
99060202103



KURT HELBORG
9947020202001



ELECTOR COUNT OF MIDDENHEIM
9947020201604



ELECTOR COUNT OF AVERLAND
9947020201902



ELECTOR COUNT OF HOCHLAND
9947020201703

The Elector Count Blister includes the Armored Horse Body & Head Sprue (99380299004) shown with Valten and Fighter Shield Sprue (99369999003) shown on opposite page.



CORE UNITS



Empire Detachment Box (16)
99120202006

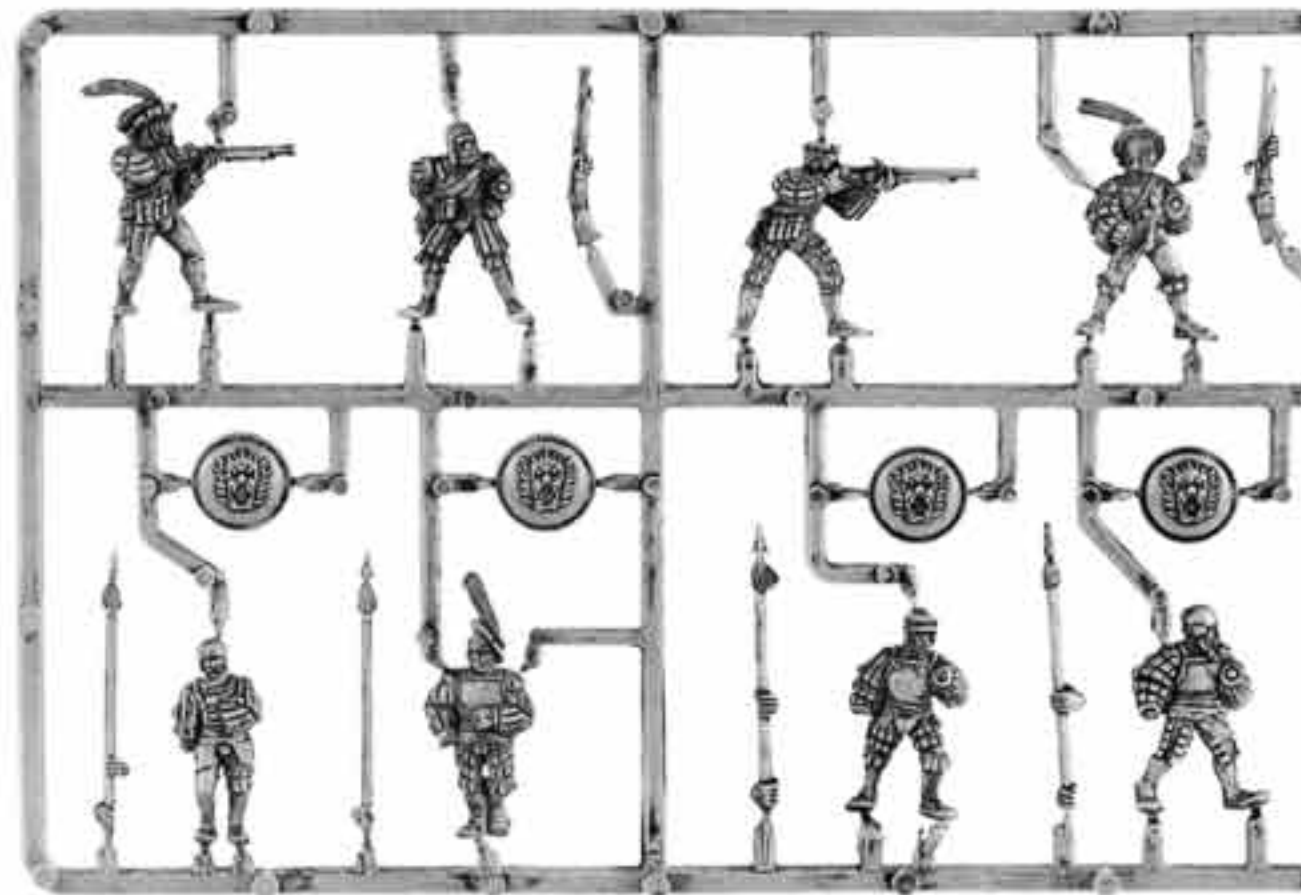

EMPIRE DETACHMENT SPRUE (SHOWN 60% ACTUAL SIZE)
99380202001

CORE UNITS

Empire Soldiers can also be assembled with hand weapons and shields.



Empire Soldiers Regiment Box (19)
99120202001

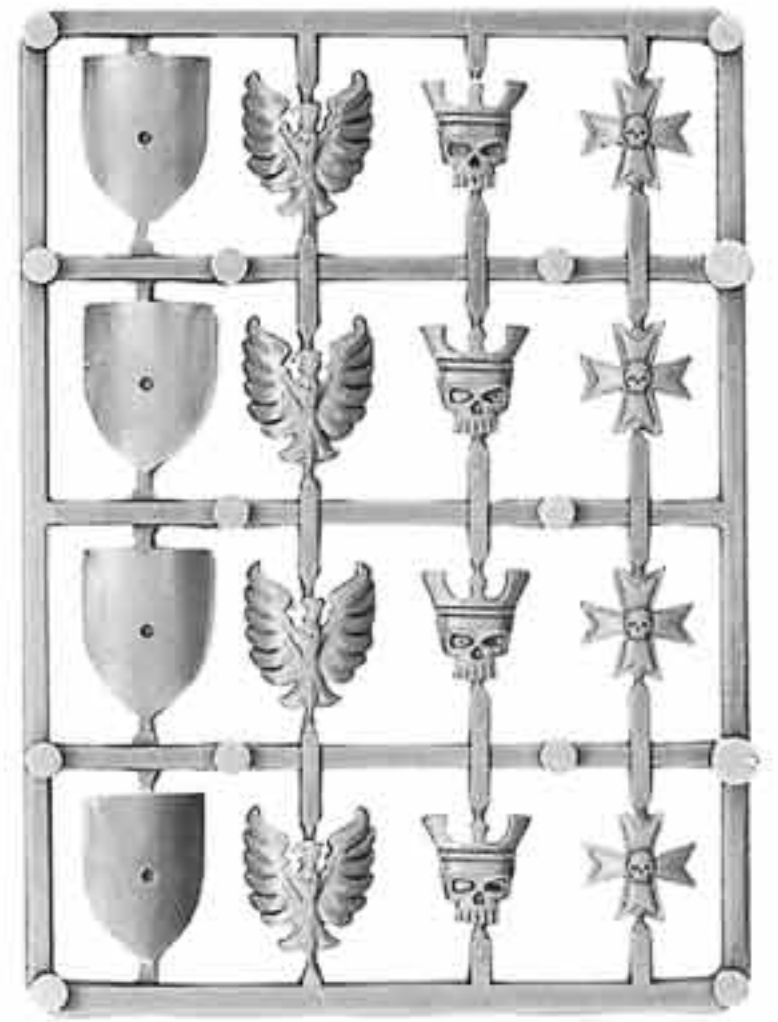

EMPIRE REGIMENT SHIELD SPRUE
99360299003

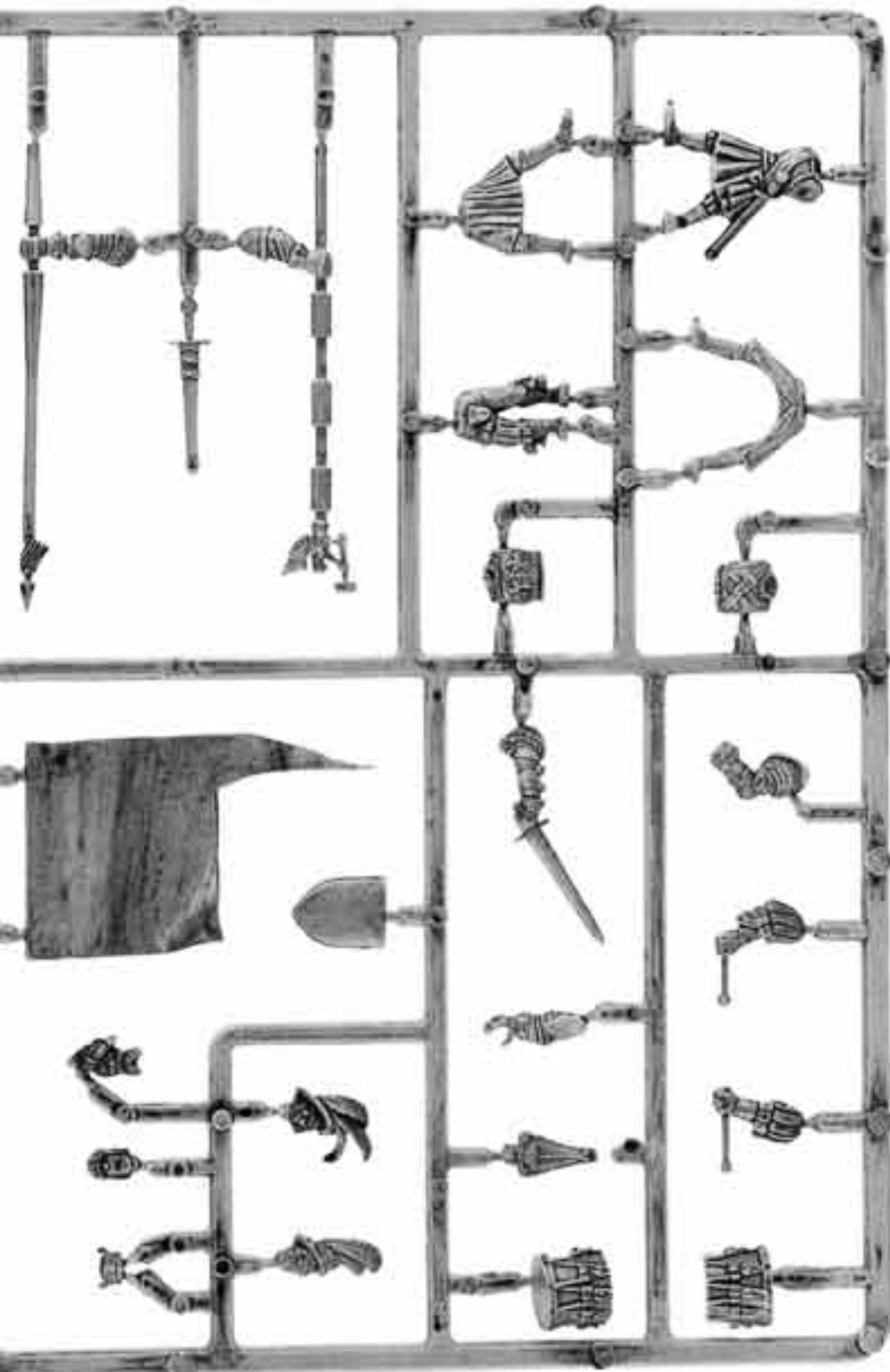

EMPIRE REGIMENT COMMAND SPRUE (SHOWN 65% ACTUAL SIZE)
99380202002

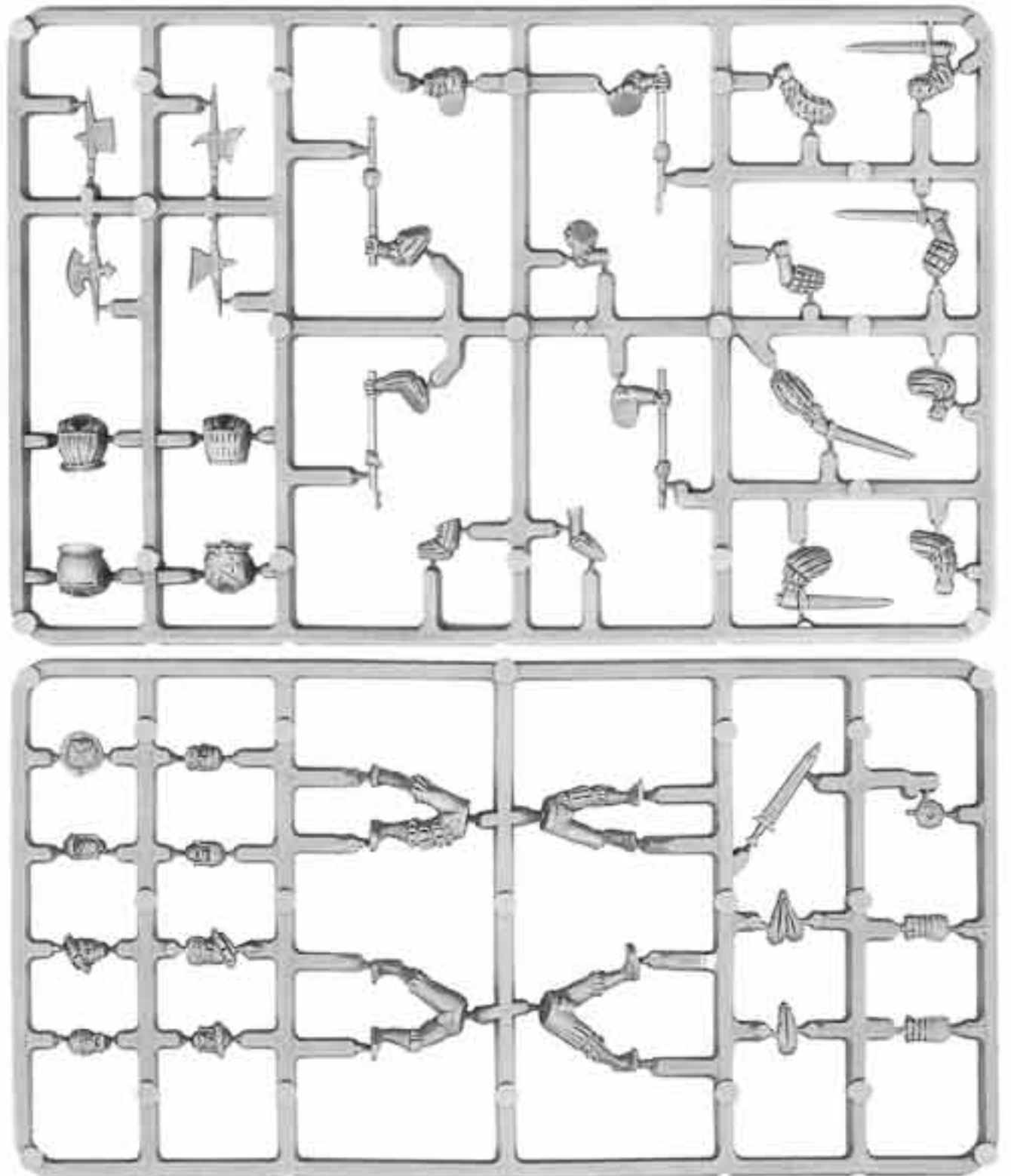

EMPIRE REGIMENT TROOPS SPRUE (SHOWN 65% ACTUAL SIZE)
99399999063

CORE UNITS

The Empire Knightly Order box includes the Armored Horse Body & Head Sprue (99380299004) shown with Valten.



EMPIRE KNIGHTS SHIELD SPRUE
99360202001



Empire Knightly Order Box (8)
99120202002

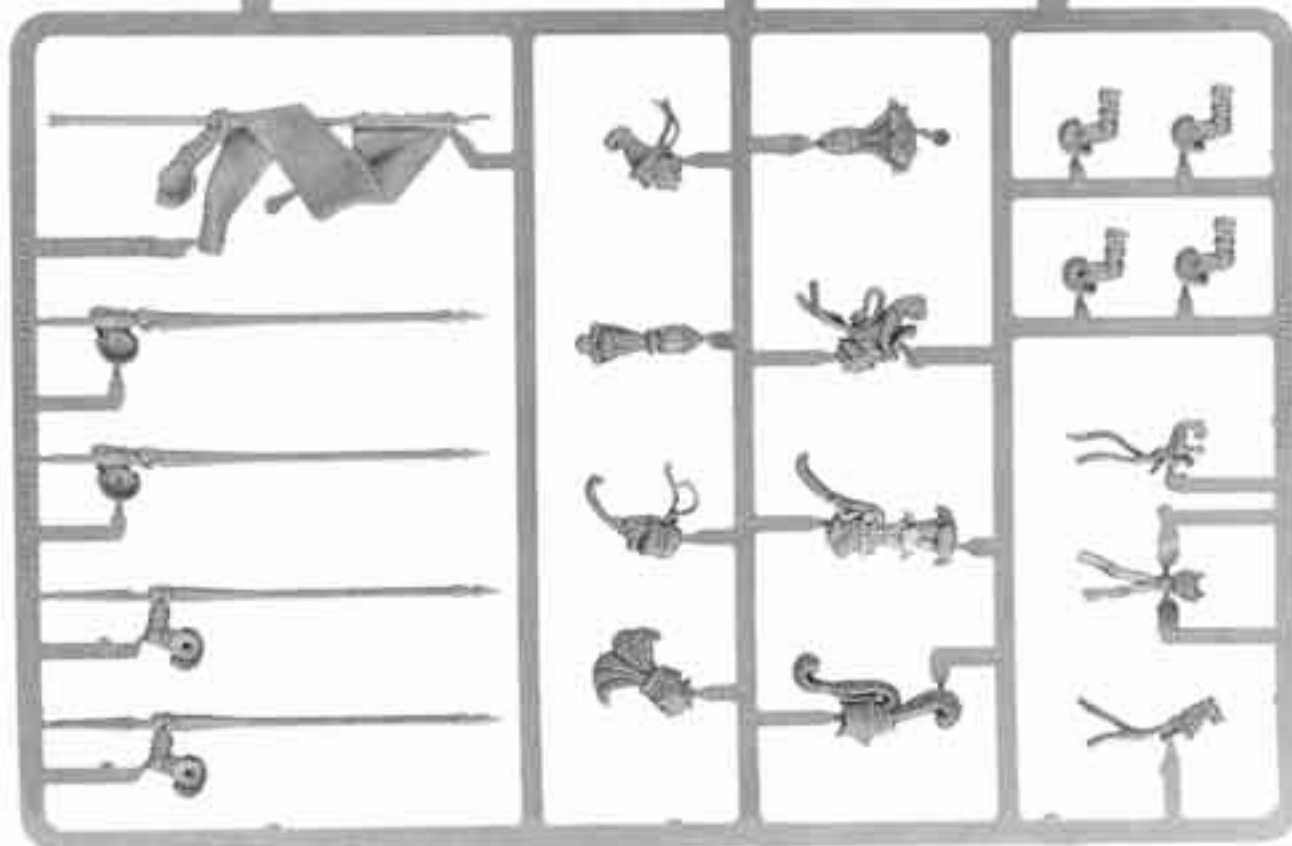
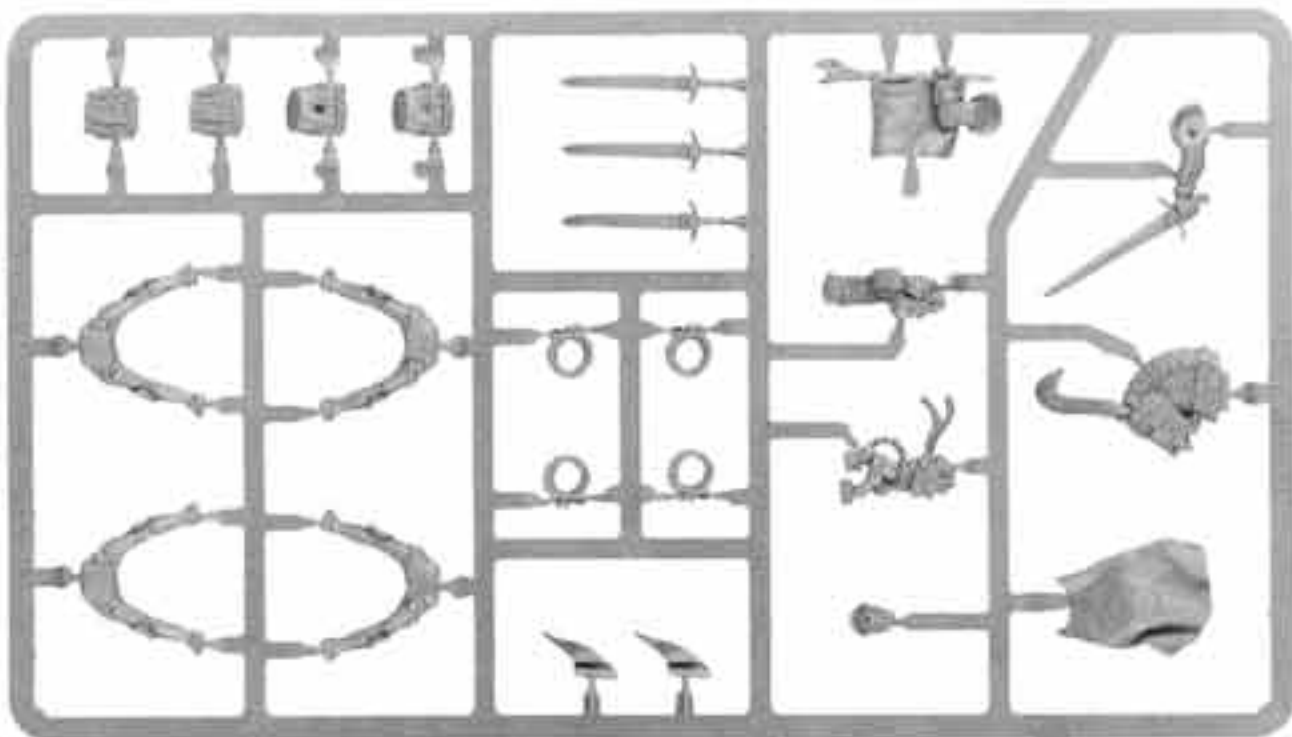

EMPIRE KNIGHTS SPRUE (SHOWN 70% ACTUAL SIZE)
99380202003

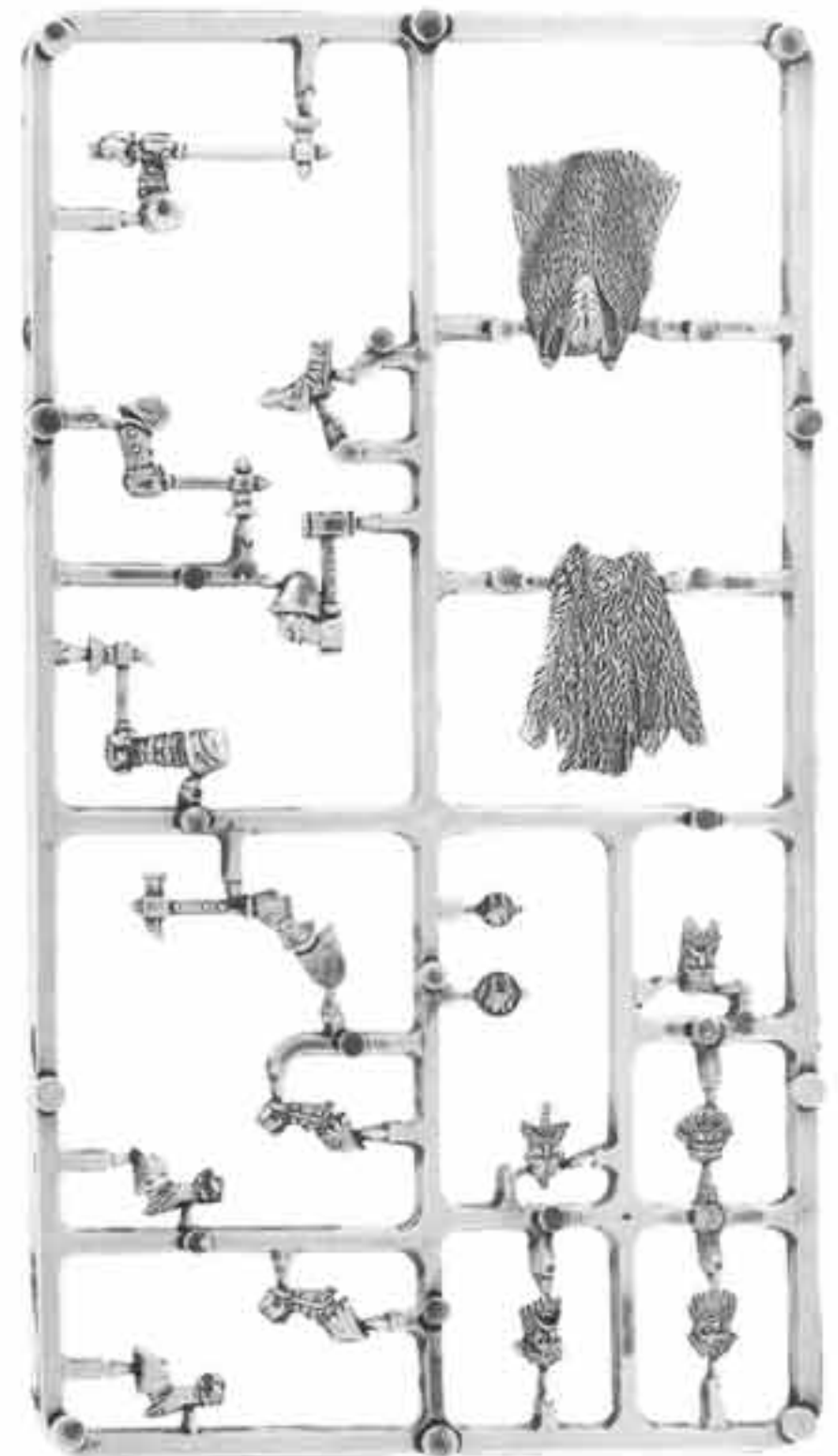

KNIGHTS OF THE WHITE WOLF SPRUE (SHOWN 80% ACTUAL SIZE)
99381102002

CORE UNITS

MAKING UNIT MOVEMENT TRAYS

Many Warhammer armies consist of a number of large regiments, and the Empire is no exception!

LARGE REGIMENTS

For large regiments, take two Games Workshop movement trays and cut off one side from each.



Glue the pieces to a piece of thin plasticard with super glue. Putty can hide the gaps.



Paint your movement tray to match your unit.



TEXTURED MOVEMENT TRAYS

For an attractive finish, texture the sides of your movement trays with glue and sand.



Paint the tray as you would the bases of your soldiers. A bit of static grass finishes the job nicely.



PLASTICARD & Balsa STRIPS

Painted plasticard and balsa strips also make good custom sized movement trays.

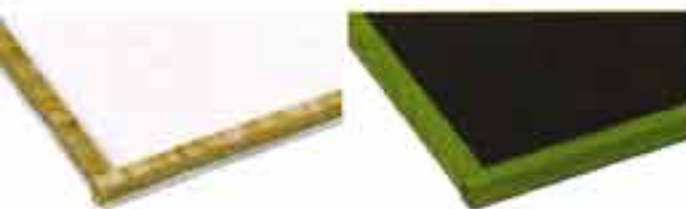

Empire Militia can also be assembled as crossbowmen or archers.

Empire Militia Box (20)
99120202004

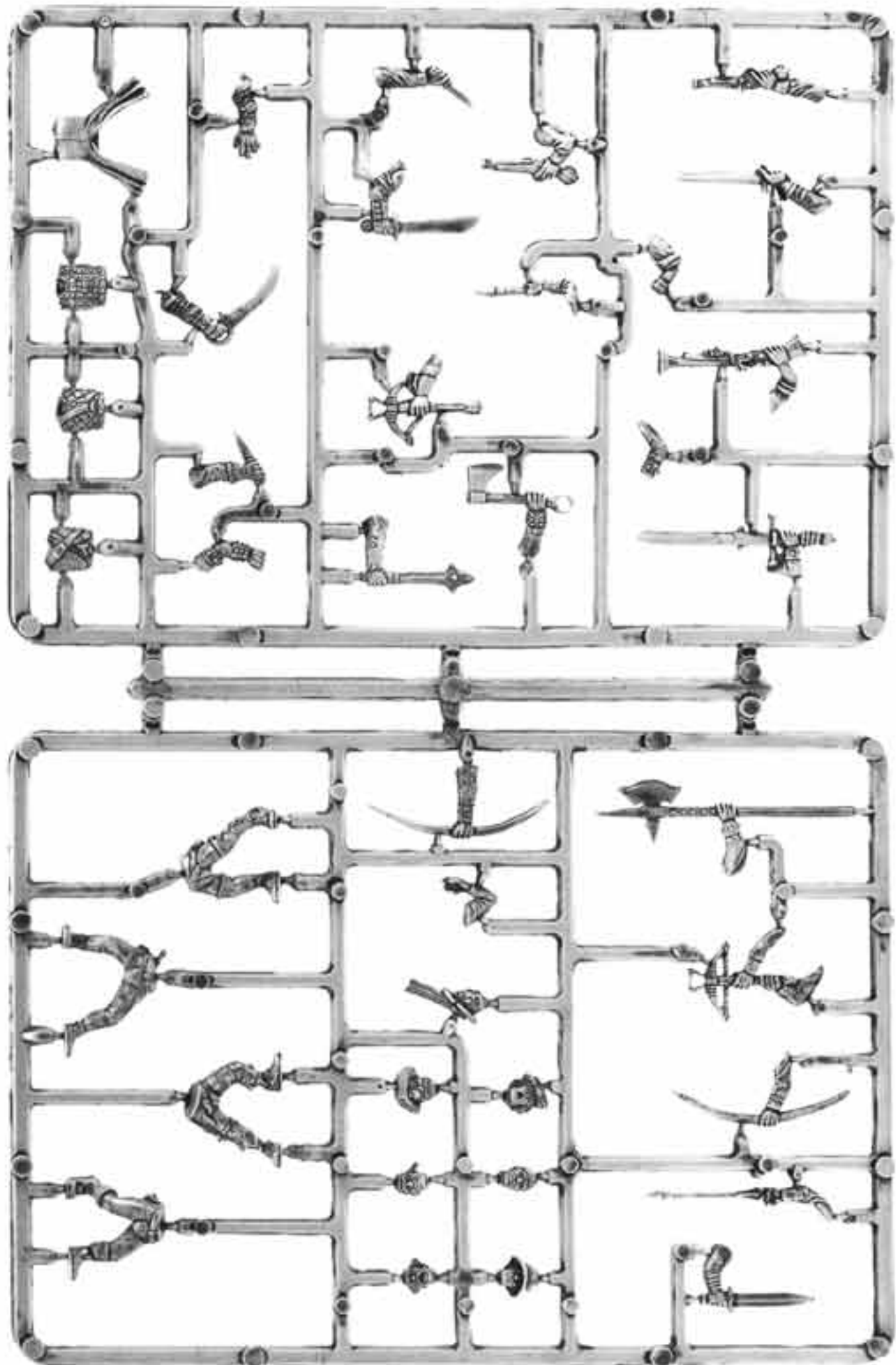

EMPIRE FREE COMPANY SPRUE (SHOWN 70% ACTUAL SIZE)
99381102001



Middenheim Teutogen Guard Regiment Box (10)
99110202200



CORE UNITS



TEUTOGEN GUARD HAMMER 1
9947020220005



TEUTOGEN GUARD HAMMER 2
9947020220006



TEUTOGEN GUARD HAMMER 3
9947020220007



TEUTOGEN GUARD HAMMER 4
9947020220008



TEUTOGEN GUARD BODY 1
9947020220001



TEUTOGEN GUARD BODY 2
9947020220002



TEUTOGEN GUARD BODY 3
9947020220003



TEUTOGEN GUARD BODY 4
9947020220004



Middenheim Teutogen Guard Command Blister (3)
99060202202



TEUTOGEN GUARD STANDARD BEARER
9947020220203



TEUTOGEN GUARD MUSICIAN
9947020220205



TEUTOGEN GUARD CHAMPION HAMMER
9947020220202



TEUTOGEN GUARD ARM
9947020220206



TEUTOGEN GUARD CHAMPION
9947020220201



TEUTOGEN GUARD STANDARD
9947020220204

SPECIAL UNITS



Empire Greatswords Regiment Box (10) & Empire Greatswords Command Blister (3)
 99110202204 99060202114



GREATSWORD 1
9947020211301



GREATSWORD 3
9947020211303



GREATSWORD 2
9947020211302



GREATSWORD 4
9947020211304



GREATSWORD CHAMPION
9947020211403



GREATSWORD DRUMMER
9947020211401



GREATSWORD STANDARD BODY
9947020211402

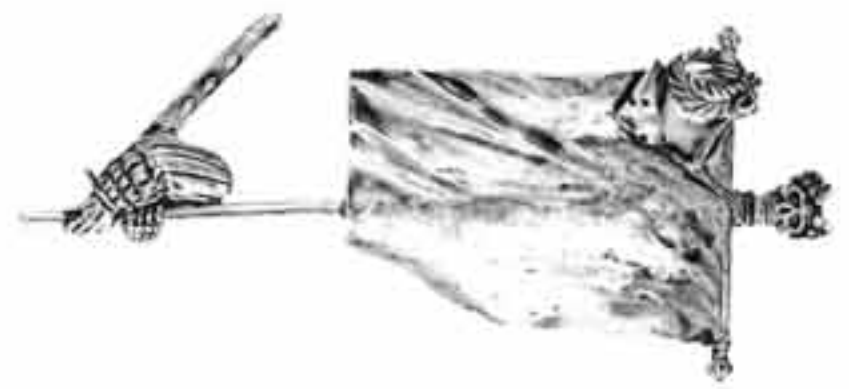

GREATSWORD BANNER
9947020211404



The Empire Cannon/Mortar Box includes enough bitz to make either 1 complete Cannon or 1 complete Mortar.



SPECIAL UNITS



Empire Cannon/Mortar Box (1)
99120202005

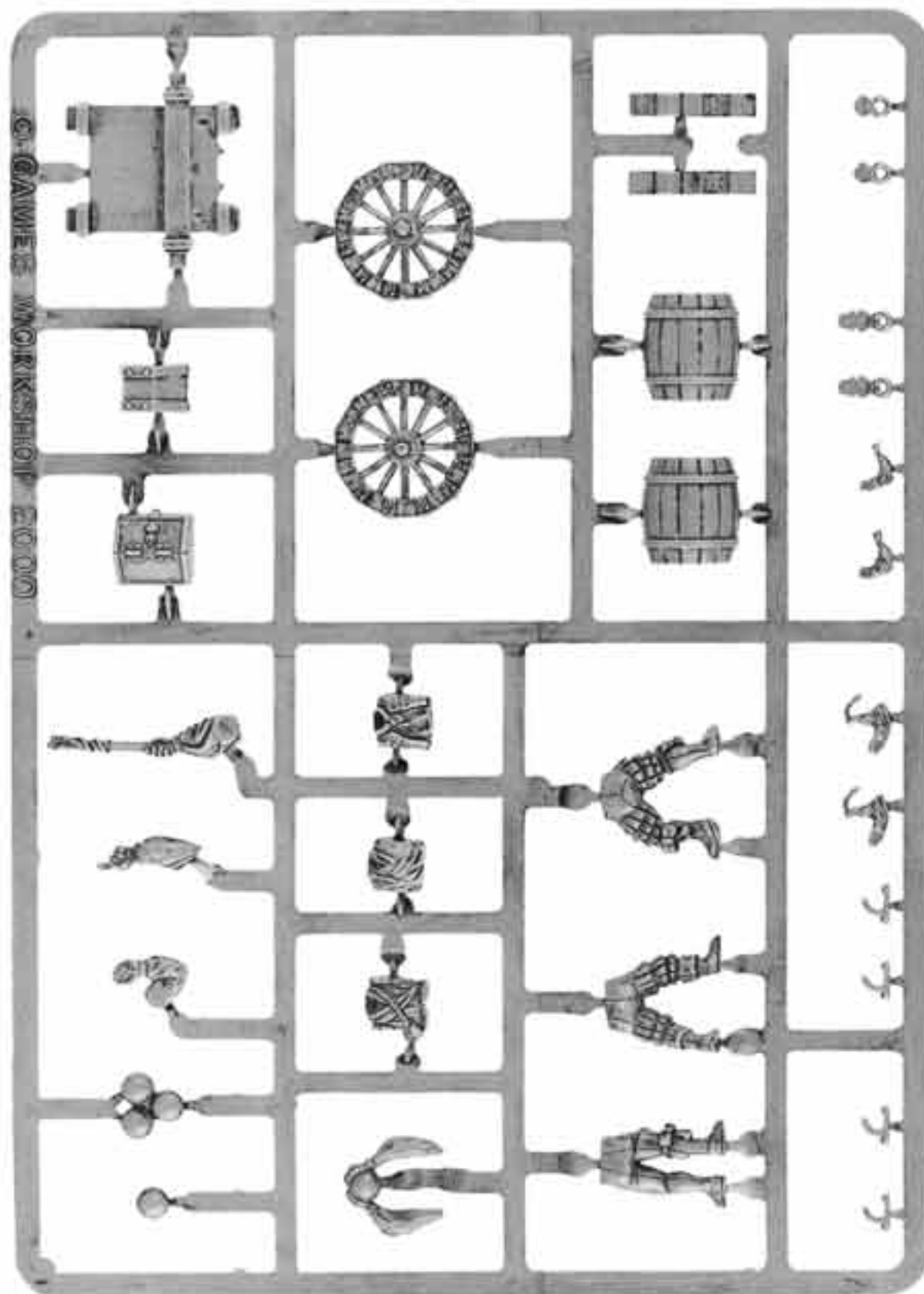

EMPIRE CANNON CREW SPRUE (SHOWN 70% ACTUAL SIZE)
99390202001

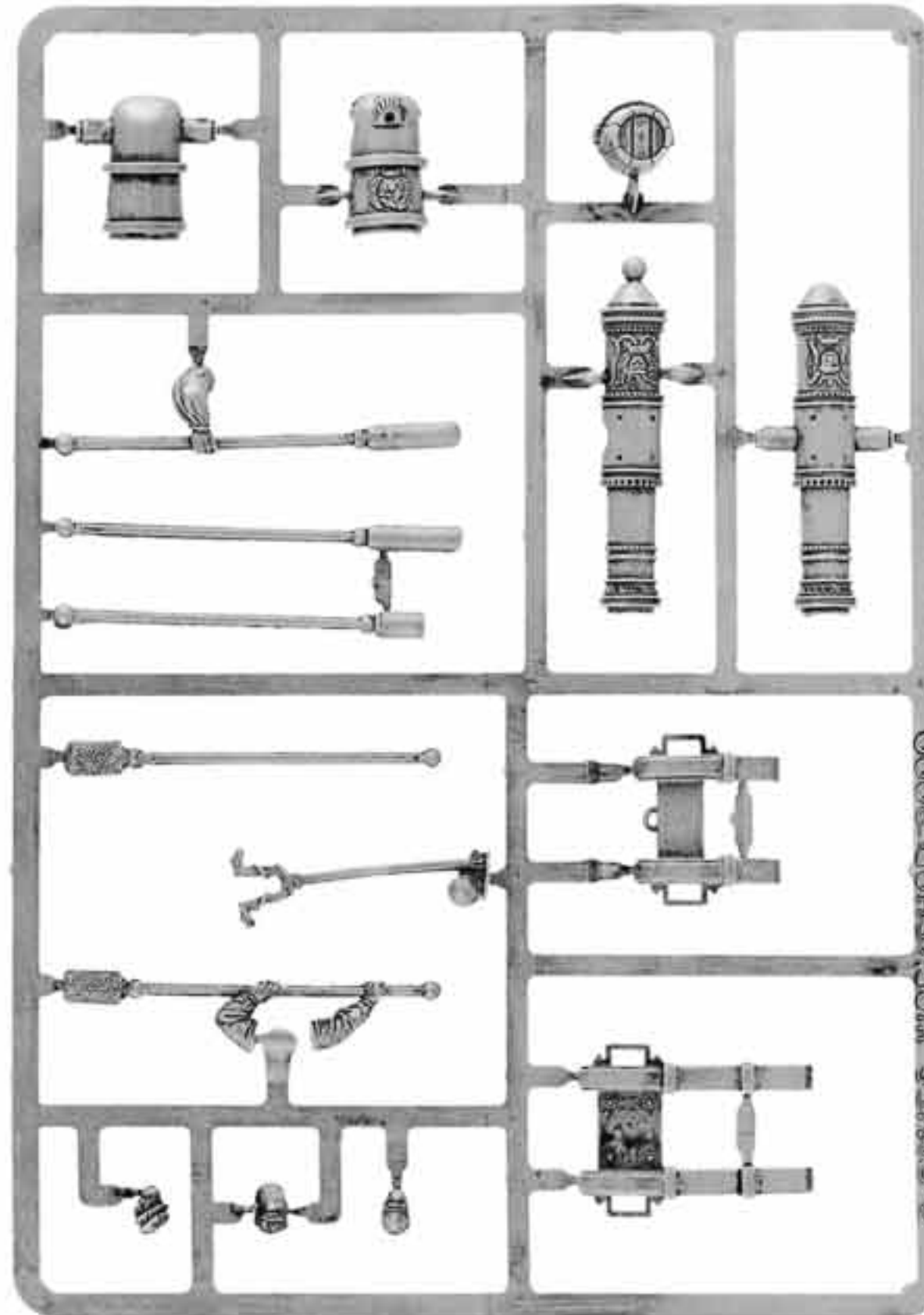

EMPIRE ARTILLERY SPRUE (SHOWN 70% ACTUAL SIZE)
99390202002

SPECIAL UNITS



PISTOLIER LEGS
9947020201204



MEDIEVAL HORSE BODY SPRUE
99389999003



MEDIEVAL HORSE HEAD SPRUE
99389999013



PISTOLIER BODY 1
9947020201201



PISTOLIER BODY 2
9947020201202



PISTOLIER BODY 3
9947020201203



Empire Pistoliers Blister (Random 1)
99060202012



RARE UNITS



Empire Flagellant Box (10)
99110202106



FLAGELLANT 1
9947020210601



FLAGELLANT 2
9947020210602



FLAGELLANT 3
9947020210603



FLAGELLANT 4
9947020210604



FLAGELLANT 5
9947020210605



FLAGELLANT 6
9947020210606

RARE UNITS



Helblaster Volley Gun Box (1)
99110202109



HELBLASTER CREW 1
9947020210901



HELBLASTER CREW 2
9947020210902



HELBLASTER CREW 3
9947020210903

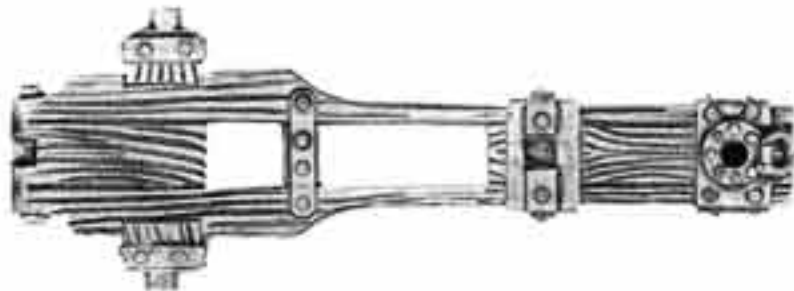

HELBLASTER CHASSIS
9947020210909



HELBLASTER FRONT PLATE
9947020210905



HELBLASTER SPRUE
9947020210907

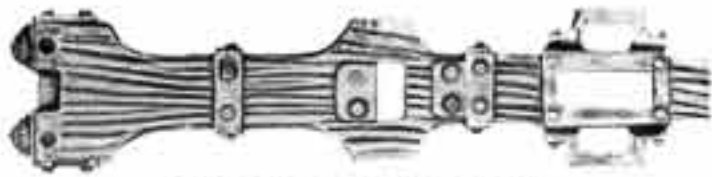

HELBLASTER GUN BEAM
9947020210911



HELBLASTER GRIFFON
9947020210908



HELBLASTER ELEVATOR BEAM
9947020210910



HELBLASTER BACK PLATE
9947020210904



HELBLASTER BARRELS
9947020210906

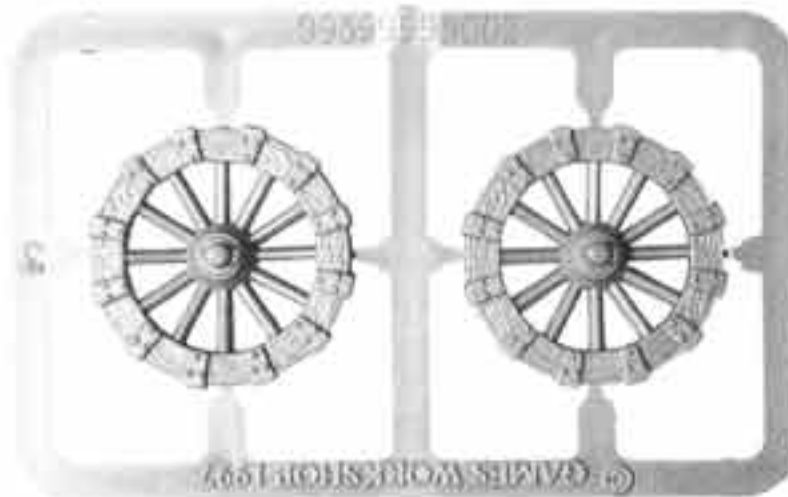

12-SPOKE WHEEL SPRUE
99399999002

MAKING WAR MACHINE BASES

Cut a piece of hardboard or thick plasticard to an appropriate size. Alternatively, you might try trimming off the edges of a standard movement tray and using it as your starting base. Glue a piece of 2" foam to the base with hot glue.



Shape the foam with a knife and sandpaper. Be sure that the foam is large enough to accommodate the war machine and crew.



Glue rocks and reeds (cut from a scrub brush and glued in place with hot glue) to the base. Next, cover the rest of the base with glue and sprinkle your basing mixture over it. Once dry, paint it black.



Highlight all the elements as you would if they were on a standard soldier's base. Add static grass and other bitz for effect.

The example below is made from a Chariot base.



RARE UNITS



Empire Steam Tank Box (1)
99110202117



**STEAM TANK
COMMANDER**
9947020211723



**STEAM TANK
COMMANDER ARMS**
9947020211724



**STEAM TANK
EAGLE**
9947020211719



**STEAM TANK
ACCESSORY SPRUE**
9947020211718



**STEAM TANK
SHROUDS**
9947020211725



STEAM TANK CANVAS
9947020211720



STEAM TANK CANNON
9947020211706



**STEAM TANK
COMMANDER STAND**
9947020211722



STEAM TANK EXHAUST PIPE
9947020211709



**STEAM TANK
FRONT WHEEL**
9947020211716



**STEAM TANK
CANNON BASE**
9947020211715



STEAM TANK WHEEL
9947020211714

RARE UNITS



STEAM TANK BARREL TOP
9947020211710



STEAM TANK BACK
9947020211712



STEAM TANK HATCH SPRUE
9947020211721



STEAM TANK BARREL BOTTOM
9947020211711

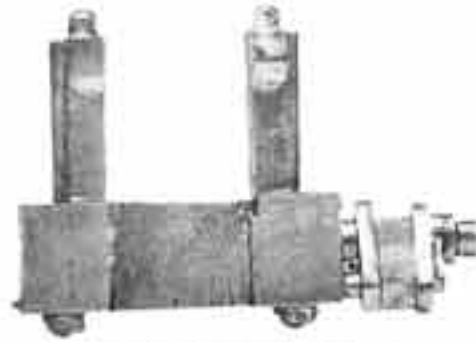

STEAM TANK AXLE
9947020211713

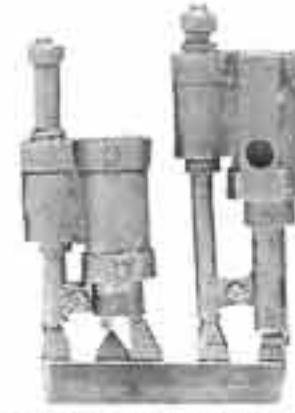

STEAM TANK HYDRAULICS
9947020211717



STEAM TANK RIGHT SIDE
9947020211701



STEAM TANK LEFT SIDE
9947020211704



STEAM TANK FRONT RIGHT SIDE
9947020211702



STEAM TANK FRONT LEFT SIDE
9947020211705



STEAM TANK BASE
9947020211703

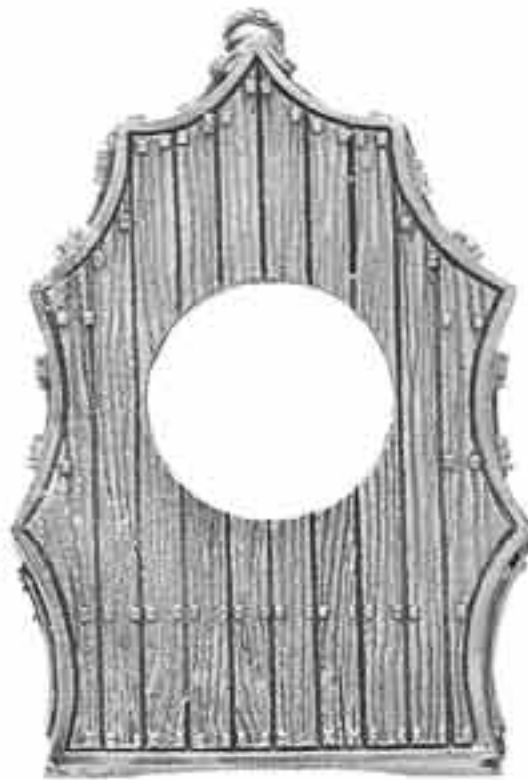

STEAM TANK TOP
9947020211707



STEAM TANK TURRET
9947020211708

DEVOTIONAL TALISMANS PURITY SEALS



Step 1. Purity seals are easily made from strips of paper and a small ball of green stuff. Glue the paper down and then press the putty into place.



Step 2. Prime and paint the model. For the seal, start with Scab Red for the wax seal and Bubonic Brown for the paper strips.



Step 3. Highlight the Scab Red with Blood Red and the Bubonic Brown with a Bubonic Brown and Bleached Bone mix and then Bleached Bone.



Step 4. Apply a final highlight to the parchment with Skull White. Thin down Chaos Black and paint thin jagged lines to represent writing.

SHIELDS



Step 1. Start with smooth plastic shield and some green stuff. After the parchment is sculpted on, press two tiny balls of putty in each corner to look like nails.



Step 2. Paint the shield Scab Red, the parchment Bubonic Brown, and the nails Chaos Black.



Step 3. Highlight the Scab Red with Red Gore. Highlight the parchment by adding more and more Bleached Bone to Bubonic Brown for successive highlights.

Step 4. Highlight the shield with Blood Red. Apply a highlight to the parchment with Skull White. Thin down Chaos Black and paint thin jagged lines to represent writing.



EMPIRE KISLEV



The Kislev are only available via Special Offer.



Warhammer Chronicles is an annual compilation of Warhammer articles along with revised or previously unpublished material. In this book, you will find the latest rules for the Empire Kislev army.

Warhammer
Chronicles 2004
60040299015

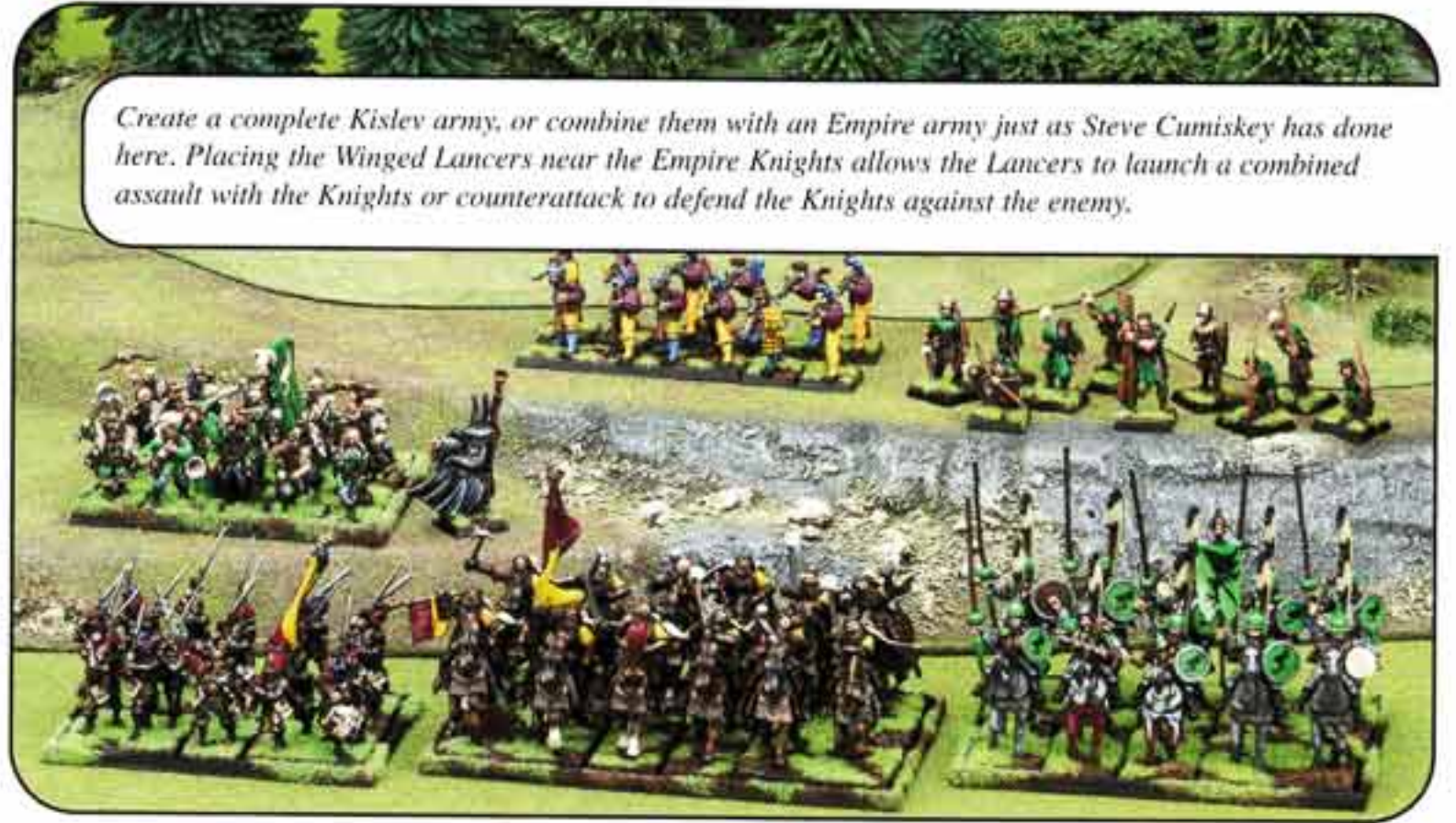

Create a complete Kislev army, or combine them with an Empire army just as Steve Cumiskey has done here. Placing the Winged Lancers near the Empire Knights allows the Lancers to launch a combined assault with the Knights or counterattack to defend the Knights against the enemy.

LORDS & HEROES



Tzar Boris was instrumental in a revival of the Ursun bear cult that had been overtaken by worship of other foreign gods. Boris undertook the trial of initiation and went into the forests to tame a bear. He was found weeks later with a gigantic bear guarding his unconscious body. After Boris came to, he returned to Kislev with the bear. Boris named the bear Urskin (meaning bear-brother), and together, they fought many battles.



TZAR BORIS WEAPON/HAT SPRUE
9947020212402



TZAR BORIS BEAR HEAD
9947020212404



TZAR BORIS BEAR LEFT SIDE
9947020212405



TZAR BORIS BODY
9947020212401



TZAR BORIS BEAR RIGHT SIDE
9947020212406



TZAR BORIS BACK BANNER SPRUE
9947020212403



Tzar Boris of Kislev on Bear Box (1)
99110202124

LORDS & HEROES

The Kislev Ice Queen Blister includes the Medieval Horse Body Sprue (99389999003) and the Medieval Horse Head Sprue (99389999013) shown with the Empire Pistoliers.



Kislev Ice Queen Blister (1)
99060202014



KISLEV ICE QUEEN BODY
9947020201401



Kislev Boyar Blister (1)
99060202195
BIT NAME: KISLEV BOYAR
BIT NUMBER: 9947020219501



Kislev Kossars Regiment Box (10)
99110202121

CORE UNITS



KISLEV KOSSAR STANDARD BEARER
9947020212803



KISLEV KOSSAR MUSICIAN
9947020212802



KISLEV KOSSAR CHAMPION
9947020212801

Kislev Kossars Command Blister (3)
99060202128



KISLEV KOSSAR 1
9947020212101



KISLEV KOSSAR 2
9947020212102



KISLEV KOSSAR 3
9947020212103



KISLEV KOSSAR 4
9947020212104



KISLEV KOSSAR 5
9947020212105



KISLEV KOSSAR 6
9947020212106

CORE UNITS



The Kislev Winged Lancers Regiment Boxed Set includes Medieval Horse Body Sprues (99389999003) and Medieval Horse Head Sprues (99389999013) shown with the Empire Pistoliers.



Kislev Winged Lancers Regiment Box (5)
99110202123



KISLEV WINGED LANCER DRUMMER BODY
9947020200807



KISLEV WINGED LANCER LEGS
9947020200701



KISLEV WINGED LANCER WING
9947020200702



LARGE ROUND SHIELD SPRUE
99369999006



KISLEV WINGED LANCER CHAMPION BODY
9947020200806



KISLEV WINGED LANCER STANDARD BODY
9947020200805

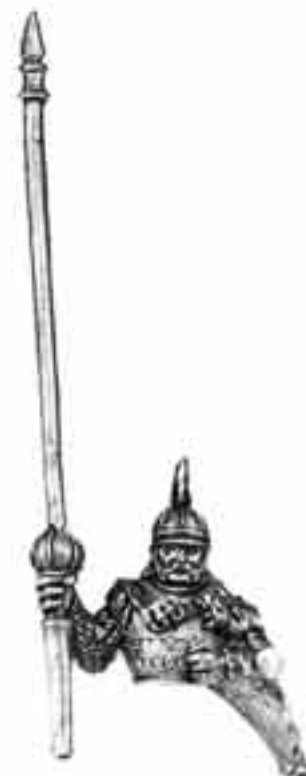

KISLEV WINGED LANCER BODY 1
9947020200703



KISLEV WINGED LANCER BODY 2
9947020200704

The Kislev Horse Archers Boxed Set includes Medieval Horse Body Sprues (99389999003) and Medieval Horse Head Sprues (99389999013) shown with the Empire Pistoliers.



Kislev Horse Archers Box (5)
99110202122



KISLEV HORSE ARCHER STANDARD BODY
9947020200603



KISLEV HORSE ARCHER CHIEFTAIN BODY
9947020200601



KISLEV HORSE ARCHER MUSICIAN
9947020200602



KISLEV HORSE ARCHER W/ SWORD 2
9947020200506



KISLEV HORSE ARCHER BODY 2
9947020200508



KISLEV HORSE ARCHER BODY 1
9947020200507



KISLEV HORSE ARCHER LEGS 4
9947020212201



KISLEV HORSE ARCHER LEGS 5
9947020212202



KISLEV HORSE ARCHER LEGS 6
9947020212203

CORE UNITS

PAINTING KISLEVITE HORSES

Kislevite Horses often have war paint on them. Here is a simple and quick way to paint your Kislevite war paint.



STEP 1
Start by priming the model Chaos Black and then paint the coat of the horse Scorched Brown.



STEP 2
Drybrush the horse's coat with Dark Flesh. Don't worry about neatness at this stage.



STEP 3
Drybrush the coat with Vermin Brown. Apply this coat sparingly and leave the previous color showing through in the recesses.



STEP 4
Paint the manes, harnesses, and other details with Chaos Black. Next, drybrush the manes and tail with Codex Grey. Highlight the reins and straps.



STEP 5
Apply Red Gore to the underbelly and legs of the horse. Apply this color carefully. It may require a few coats for full coverage.



STEP 6
Drybrush the Red Gore areas with Blood Red. To finish, follow the drybrush with a final highlight of Blood Red with a little Blazing Orange mixed in.



SPECIAL UNITS



The Kislev Gryphon Legion Regiment Boxed Set includes Medieval Horse Body Sprues (99389999003) and Medieval Horse Head Sprues (99389999013) shown with the Empire Pistoliers and Large Round Shield Sprues (99369999006) shown with the Kislev Winged Lancers.



KISLEV GRYPHON LEGION STANDARD
9947020219604



KISLEV GRYPHON LEGION MUSICIAN ARM
9947020219606



KISLEV GRYPHON LEGION SWORD ARM
9947020219602



Kislev Gryphon Legion Regiment Box (5)
99110202196



KISLEV GRYPHON LEGION LANCE
9947020219609



KISLEV GRYPHON LEGION CHAMPION BODY
9947020219601



KISLEV GRYPHON LEGION MUSICIAN BODY
9947020219605



KISLEV GRYPHON LEGION STANDARD BODY
9947020219603



KISLEV GRYPHON LEGION WING
9947020219610



KISLEV GRYPHON LEGION BODY 1
9947020219607



KISLEV GRYPHON LEGION BODY 2
9947020219608

TACTICS



TIPS FOR WINNING WITH THE EMPIRE

- A. Perhaps the Empire army's greatest strength is its flexibility. You can throw your regular opponents for a loop by varying the type of Empire army you field: an all-cavalry force, a stand-and-shoot army, a "horde" army of all State Troops and Militia, or an artillery-heavy force. Though your opponents may know that they're preparing to play an Empire army, they'll never be sure *which* Empire army will take to the field.
- B. While there are a number of great suits of magic armor in the Empire arsenal, it is often more effective (and sometimes cheaper) simply to equip your character models with full plate armor, a shield, and a barded warhorse for a 1+ armor save. Even though all this kit costs 36 points for a Lord and 24 points for a Hero, these points do not come out of the allotment that can be spent on magic items, which enables your characters to carry more powerful magic.
- C. If an Elector Count serves as your General, one unit of State Troops can carry a magic banner worth up to 50 points. It's often a good idea to equip a sizeable unit of Halberdiers or Spearmen with the Griffon Standard to double its normal rank bonus from +3 to +6. The Griffon Standard can turn a middling unit of State Troops into a real combat monster!
- D. Flagellants are flexible troops that can be used to tie up powerful enemy units; to guard weak flanks, vulnerable artillery and missile troops, and battlefield objectives; and to defeat weak and middling enemy troops.

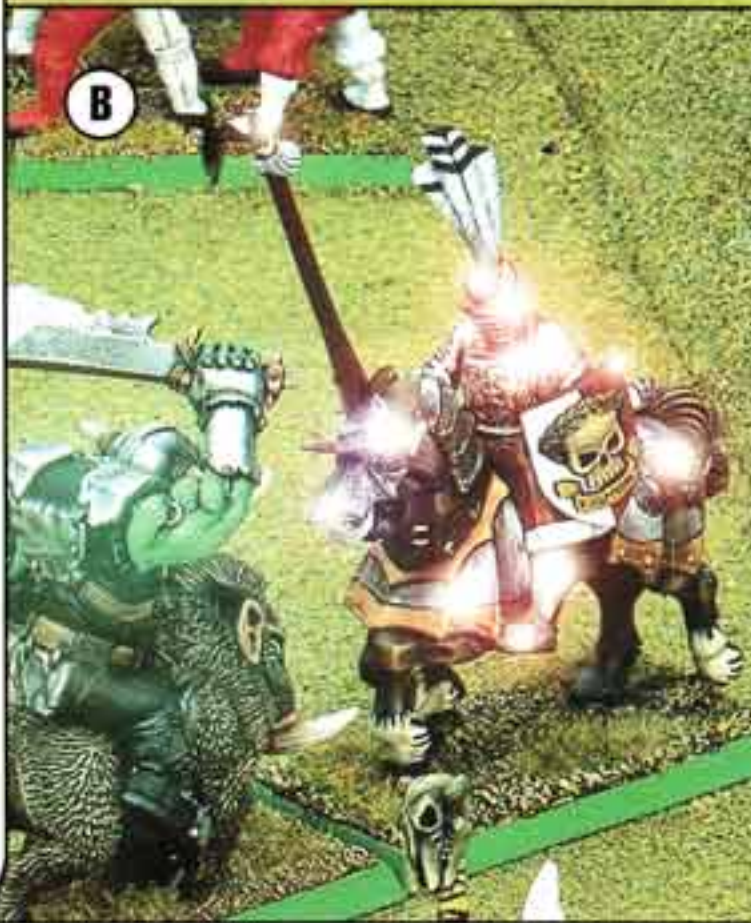

COUNTERTACTICS

TIPS FOR FIGHTING AGAINST THE EMPIRE

- A. If a regular opponent has a large collection of Empire models and tends to vary the composition of his force radically from game to game, you can counter by bringing a tournament-style force designed to take on a variety of types of armies.
- B. There are a number of weapons that do not allow armor saves that are perfect for attacking heavily armored Empire characters and Knights. When you're preparing to face an Empire army, particularly one you know to have a lot of heavy cavalry, it's a good idea to include Cannons, Stone Throwers, and Bolt Throwers. Also, many magic spells and weapons ignore armor saves and can be useful when facing Empire troops. Alternatively, models with high Strength – e.g., those with great weapons, cavalry with lances, Chariots, and Monsters – can reduce the saves of heavily armored troops.
- C. Once you learn that a unit has the Griffon Standard, do your best to flank it. When the unit loses its rank bonuses, the Griffon Standard becomes useless, and the unit will be likely to fold.
- D. Flagellants can be frustrating opponents, particularly when they tie up your most powerful units for multiple turns. Only engage them with powerful units that can dish out a lot of attacks and kill the Flagellants quickly. Do the math in your head beforehand and only engage with troops that can destroy the Flagellants in no more than 2 or 3 player turns. Troops with WS5 or higher are great for this task, as the WS2 Flagellants will require 5's to hit. Alternatively, if you have fast troops like cavalry or flyers, you can lure the Flagellants toward your troops, and then run circles around the Flagellants and avoid them like the plague.





KEY

■ Top Box(es): Basecoat Colors & Ink Washes

■ Bottom Box(es): Highlights

■ Mixed Colors



ALTDORF
Scab Red, Ultramarines Blue
Blood Red, Ice Blue



AVERLAND
Golden Yellow, Chaos Black
Bad Moon Yellow, Fortress Grey



BOGENHAFEN
Bubonic Brown, Liche Purple & Chaos Black
Bleached Bone & Skull White, Liche Purple



HOCHLAND
Scab Red, Snot Green
Blood Red, Scorpion Green



KOSSARS
Red Gore, Enchanted Blue
Blood Red, Ice Blue



MIDDENHEIM
Codex Grey, Regal Blue
Skull White, Ice Blue



MIDDENLAND
Enchanted Blue, Chainmail
Ice Blue, Mithril Silver



NORDLAND
Enchanted Blue, Golden Yellow & Red Ink
Ice Blue, Bad Moon Yellow



NULN
Chaos Black, Desert Yellow
Shadow Grey, Desert Yellow & Bleached Bone



OSTERMARK
Terracotta, Golden Yellow
Blood Red, Sunburst Yellow



OSTLAND
Chaos Black, Red Gore
Skull White, Blood Red



REIKLAND
Bleached Bone, Scab Red
Skull White, Blood Red



STIRLAND
Dark Angels Green, Golden Yellow
Scorpion Green, Bad Moon Yellow



STIR RIVER
Goblin Green, Fortress Grey
Scorpion Green, Skull White



WISSENLAND
Codex Grey, Chaos Black & Codex Grey
Skull White, Fortress Grey



COLORS OF WAR

KEY

Top Box(es): Basecoat Colors & Ink Washes
 Bottom Box(es): Highlights
 Mixed Colors

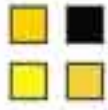

GRAND MASTER OF THE BLAZING SUN
Golden Yellow, Chaos Black
Bad Moon Yellow, Burnished Gold



GRAND MASTER OF THE KNIGHTS PANTHER
Blazing Orange, Regal Blue
Sunburst Yellow, Ice Blue



GRAND MASTER OF THE WHITE WOLF
Shadow Grey, Codex Grey
Skull White, Space Wolves Grey



Brett DeWald's Knights of the Blazing Sun won first place at the 2004 Baltimore Games Day Golden Demon Painting Competition.

SHOWCASE



Left: Bryan Shaw won second place with his Warrior Priest of Ulric at the 2004 Los Angeles Games Day Golden Demon Painting Competition.



Below: Captain Kutusev by Doug Jones won second place at the 2004 Chicago Games Day Golden Demon Painting Competition.



ALTERNATE MODEL – CORE Border Prince Troops

COMPONENTS FOR 4 COMPLETE MODELS

- 99360299003 Empire Shield Sprue
- 99380203002 Men-at-Arms Sprue
- 99381102001 Empire Militia Sprue

COMPLEXITY RATING



Above: Brett DeWald's Ostermark Pegasus Rider won first place at the 2004 Baltimore Games Day Golden Demon Painting Competition.

ALTERNATE MODEL – SPECIAL Empire Great Cannon

COMPONENTS FOR 1 CANNON & 3 CREW

- 99381102001 Empire Militia Sprue
- 99390202001 Empire Crew Sprue
- 99390202002 Empire Artillery Sprue
- 9947020211714 Steam Tank Rear Wheel

COMPLEXITY RATING



Below: Liliana Troy's Tzar Boris on Bear won second place at the 2004 Los Angeles Games Day Golden Demon Painting Competition.



SHOWCASE

Below: Seb Perbet's Empire Hero won third place at the 2003 UK Games Day Golden Demon Painting Competition.



Above: Matt Buck's Empire Greatsword was a runner-up at the 2004 Baltimore Games Day Golden Demon Painting Competition.

Below: Doug Jones won first place at the 2004 Chicago Games Day Golden Demon Painting Competition with his Erengrad Gryphon Legion.



HIGH ELVES

We, the Asur, are a noble people, our long and proud history stretching back to a time when Men were still fur-clad savages. Living on our fair isle of Ulthuan, set in the center of the Great Ocean, we are far removed from the petty squabbles of the lesser races. Here, we are able to practice our magic and our arts, perfecting them for no reason other than the sheer joy of it.

We are a tall and slender people, slight of build and graceful of movement. Our armies, too, move with fluid grace as do our warships and steeds. All that we touch is elegant and finely crafted, for we are a long lived people and refuse to surround ourselves with ugliness and discord. During our long lives, we are able to perfect many skills, and our people are renowned for our highly skilled artisans, our fine craftsmen, the beauty of our art, and the melodious grace of our songs. All in all, we are a race that loves beauty and treasures skill, but our days are not all spent in idle pursuits.

Since the time of the Sundering, we have been a besieged and embattled people. Our cursed Dark Elf cousins are bent on nothing short of complete dominion over us, and their treacherous leader Malekith will not rest until he sits on the Phoenix Throne. To repel this unending barrage of piracy and raids, we must train constantly for war and remember the Golden Age before this hellish time of strife.

The High Elves are an ancient race that once ruled the Warhammer world. The High Elves are seafarers and powerful in magic, but the High Elves long ago retreated to their island homeland of Ulthuan. Noble or haughty, depending on your viewpoint, the High Elves live in self-imposed isolation. They fight to protect their home and preserve their way of life.

Fighting Style

In most aspects, the High Elves are a general's dream. They are fast, are skilled with sword and bow, have access to expert cavalry, and have a variety of elite units to choose from. High Elf armies are often outnumbered, and wise High Elf

tacticians will try to avoid senseless frontal assaults or battles of attrition. After all, why use a sledgehammer when a rapier is what's needed?

High Elf armies are best when exploiting their flexibility. They can present an impregnable line of spears in defensive formation when needed or send out brilliant counterstrikes of fast-moving cavalry. A mass of Archers and a few Eagle's Claw Repeater Bolt Throwers can blunt even the most determined mass attack. Few foes can withstand the charge of units such as Swordmasters or Dragon Princes, especially when these charges are combined with supporting charges from speedy Tiranoc Chariots or Great Eagles.

Collecting a High Elf Army

The first step to collecting a High Elf army is to get your hands on a few Core choices. They will fulfill your minimum army requirements, and even the most basic of High Elven troops, the Archers (with BS4) and Spearmen (with WS4 and the ability to fight in three ranks!), are experts to rival the elites of other armies. Players who can't decide between Archers and Spearmen should consider Lothorn Sea Guard – a unit that incorporates both weapon types.

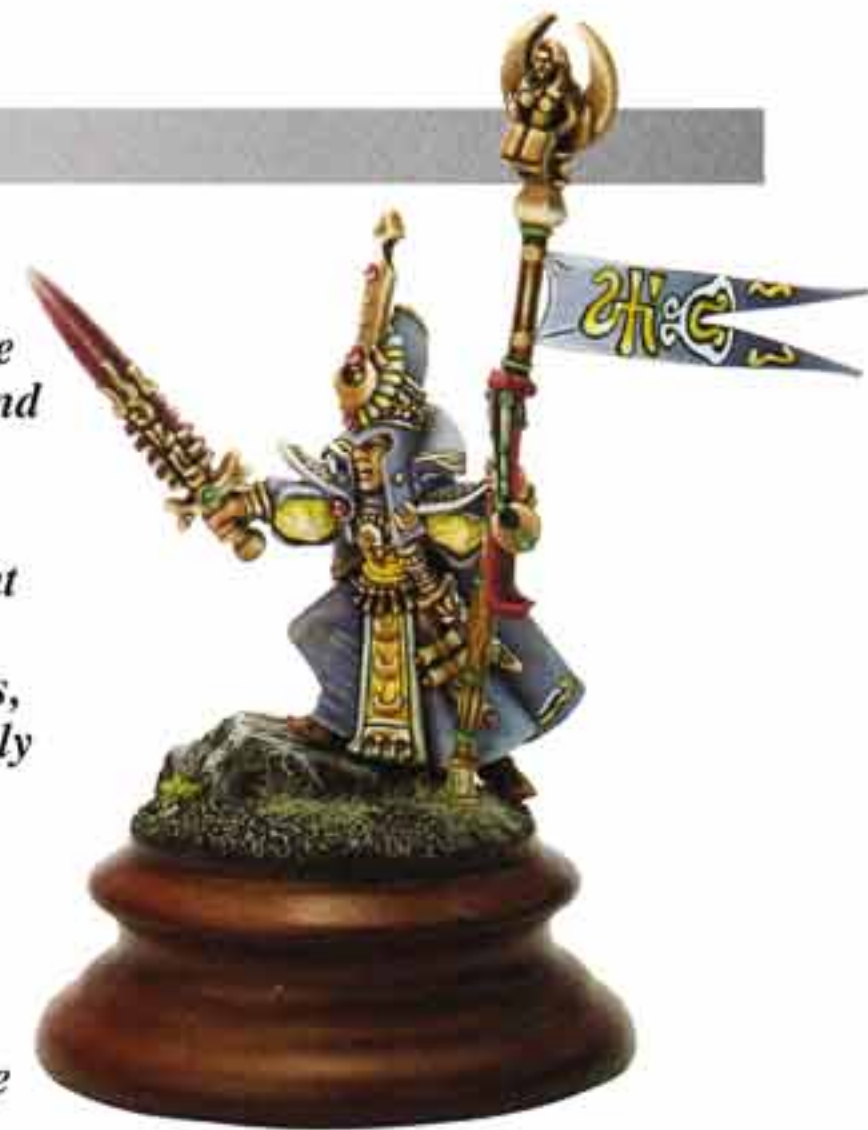

Aaron Wilson entered this High Elf Mage at the 2004 Chicago Golden Demon Painting Competition.

When expanding a High Elf army, it is well worth looking at cavalry (Silver Helms, Ellyrian Reavers, and Dragon Princes), especially if you are the kind of player who will put a premium on attacking and counterstrikes. High Elf elite infantry units (Swordmasters of Hoeth, White Lions, and Phoenix Guard) all have extra abilities that make them well worth their higher points cost. For instance, the Phoenix Guard not only have a higher Weapon Skill (5) but also wield halberds (+1 Strength) and cause *Fear*.

When first assembling a High Elf force, some players are tempted to purchase one of each of the fantastic High Elf elite troop types. Such an approach may work, but it will result in a very small army. The way to decide which troops are best for your style of play is to get some Core troops painted and fight some battles. If you want a more defensive force, you may want to go for more Archers and Repeater Bolt Throwers as well as elite troops that will slow the enemy advance like Shadow Warriors (who *Scout* and *Skirmish*) or Ellyrian Reavers (excellent *Fast Cavalry*). Defensive forces can include Spearmen and a few harder units (Swordmasters or Dragon Princes) to counterattack as the enemy closes. Of course, if you build a large enough army, you can switch forces in and out to favor any playing style.

The High Elves have been rightfully feared over 5,000 long years of history. It is up to you to continue their legacy of excellence.



Shawn Wagner painted this amazing Repeater Bolt Thrower.



High Elf Battalion Box 99120210007

- 8 Silver Helms
- 16 Archers
- 16 Spearmen
- 1 Bolt Thrower



GETTING STARTED



This 80-page rulebook contains painting and modeling guides, background, and the full rules for fielding an army of ancient and deadly High Elves.

**Warhammer Armies:
High Elves**
60030210002

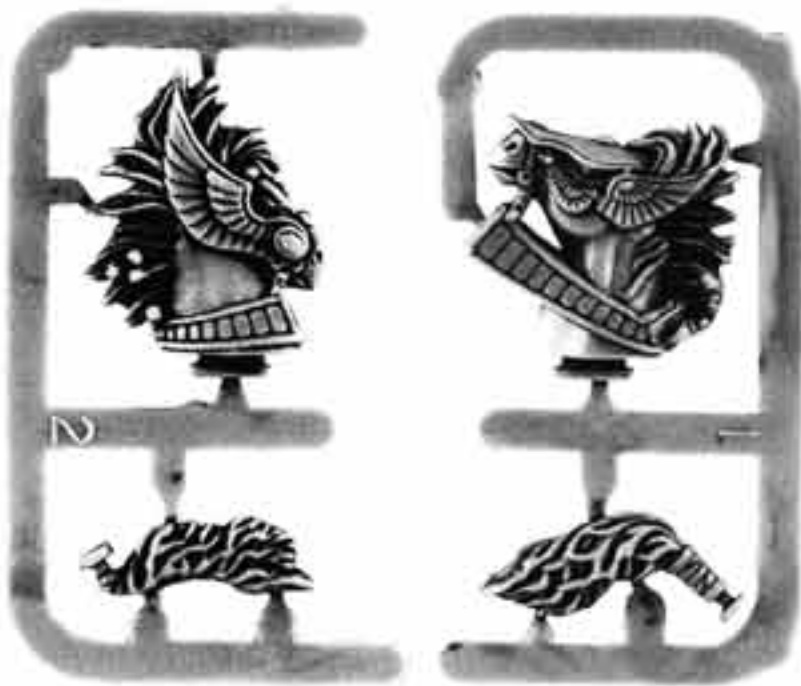

BARBED ELVEN STEED HEAD SPRUE (RANDOM 1)
99389999016



LORDS & HEROES



High Elf Lords Blister (Random 1)
99060210091

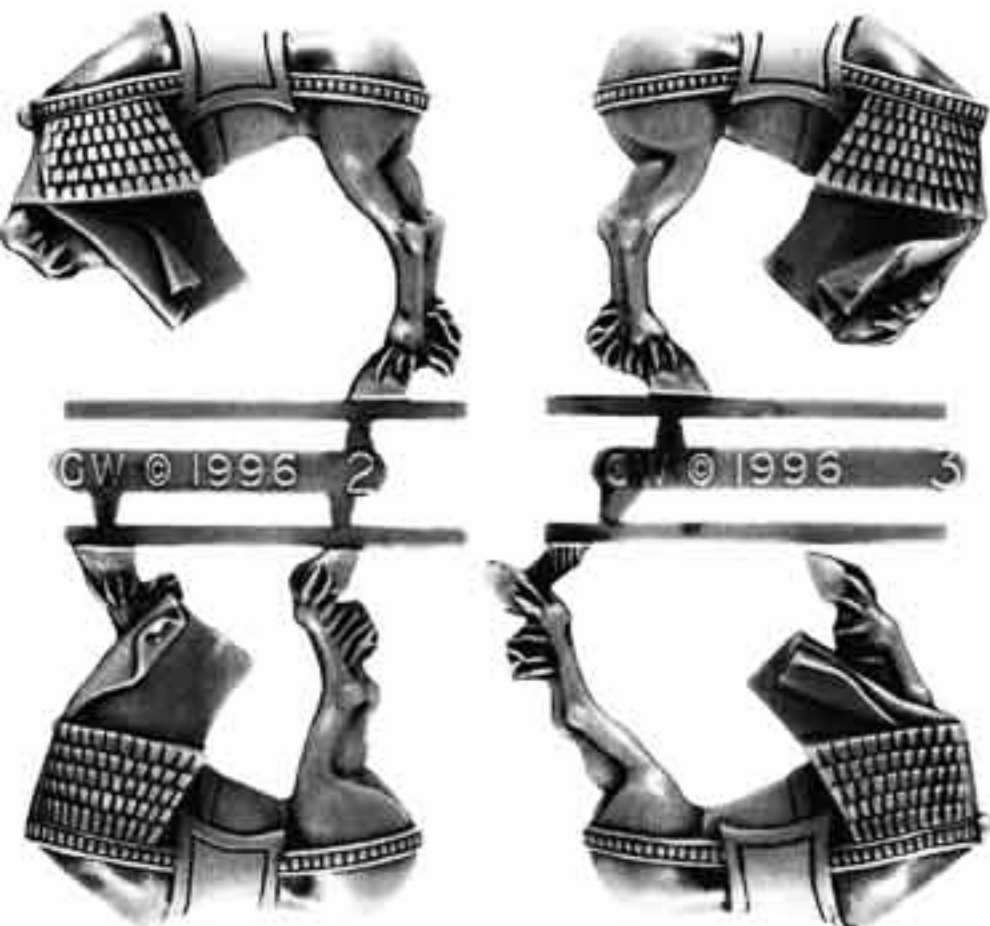

BARBED ELVEN STEED BODY SPRUE (RANDOM 1)
99389999006



GENERAL BODY
9947021001601



HERO 1 BODY
9947021001703



GENERAL LEGS
9947021001602



HERO LEGS
9947021001701



ELF SHIELD SPRUE
99369999002



LORDS & HEROES



HIGH ELF HERO 1 BODY
9947021011401



HIGH ELF HERO 1 SPRUE
9947021011402



Heroes Blister (Random 1)
99060210114



HIGH ELF HERO 2 BODY
9947021011403



HIGH ELF HERO 2 SPRUE
9947021011404



HIGH ELF HERO 3 BODY
9947021011405



HIGH ELF HERO 3 BOW
9947021011406



Mage Blister (Random 1)
99060210113



HIGH ELF MAGE 1
9947021011301



HIGH ELF MAGE 2 BASE
9947021011303



HIGH ELF MAGE 3 EAGLE
9947021011305



HIGH ELF MAGE 2 BODY
9947021011302



HIGH ELF MAGE 3 BODY
9947021011304



LORDS & HEROES



Tyrion, Defender of Ulthuan Box (1)
99110210101



TYRION BODY
9947021010101



TYRION HORSE HEAD
9947021010103

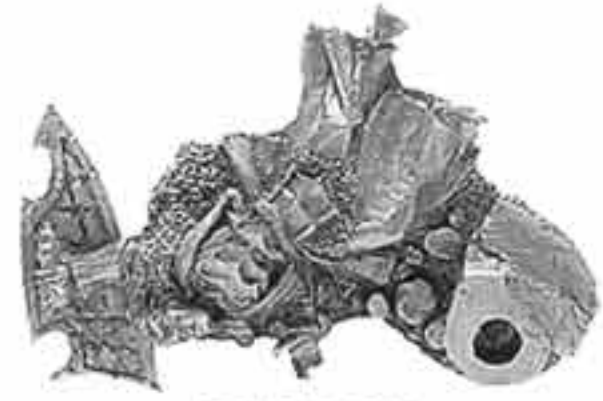

TYRION BASE
9947021010108



TYRION HELMET SPRUE
9947021010107



TYRION ARM
9947021010102



TYRION HORSE TAIL
9947021010105



Eltharion Blister (1)
99060210111



TYRION HORSE LEFT SIDE
9947021010104



TYRION HORSE RIGHT SIDE
9947021010106



ELTHARION BODY
9947021011101



Teclis High Loremaster of
The White Tower Blister (1)
99060210107



TECLIS BODY
9947021010701



TECLIS STAFF
9947021010702



ELTHARION SWORD
9947021011102



LORDS & HEROES



PRINCE IMRIK LANCE
9947021010203

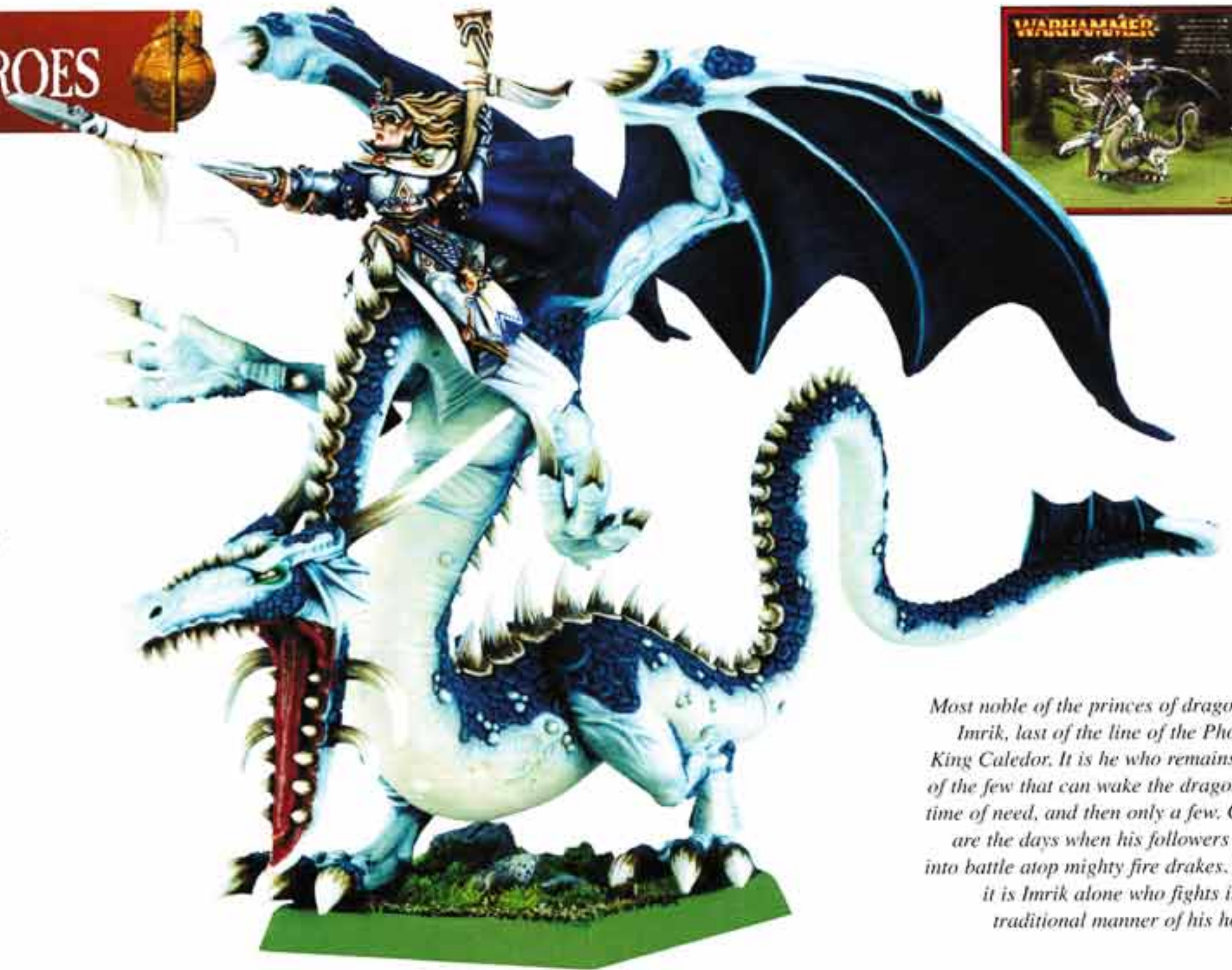

Imrik, Dragon Prince of Caledor Box (1)
99110210102

Most noble of the princes of dragons is Imrik, last of the line of the Phoenix King Caledor. It is he who remains one of the few that can wake the dragons in time of need, and then only a few. Gone are the days when his followers rode into battle atop mighty fire drakes. Now it is Imrik alone who fights in the traditional manner of his house.

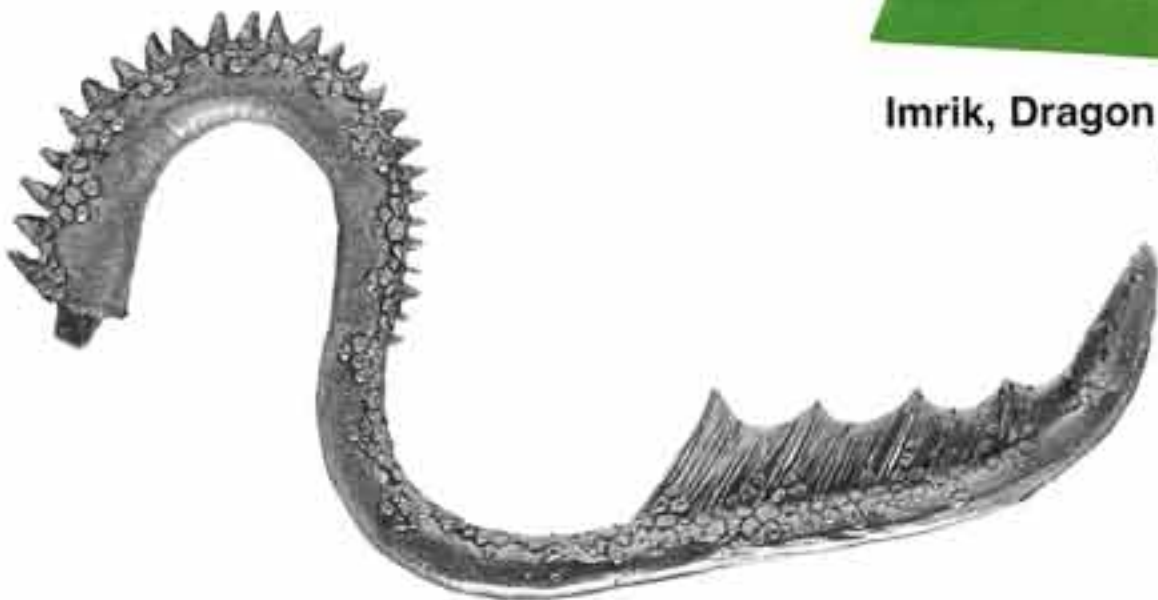

PRINCE IMRIK DRAGON TAIL
9947021010209



DRAGON WINGS SPRUE
99380299002



PRINCE IMRIK DRAGON UPPER JAW
9947021010204



PRINCE IMRIK DRAGON LOWER JAW
9947021010205



LORDS & HEROES

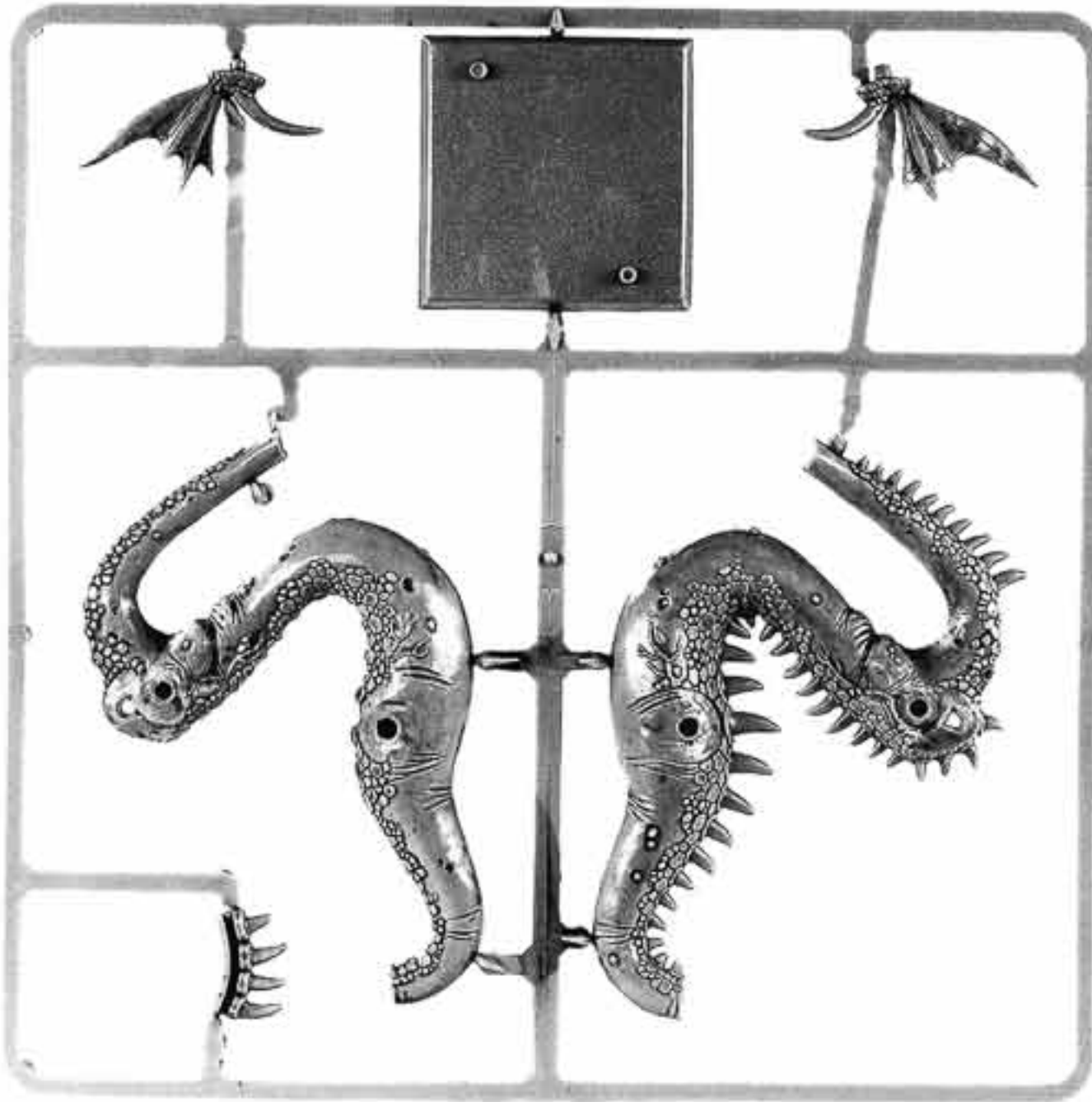

DRAGON BODY SPRUE (SHOWN 60% ACTUAL SIZE)
99389999075



PRINCE IMRIK BODY
9947021010201



PRINCE IMRIK LEGS
9947021010202

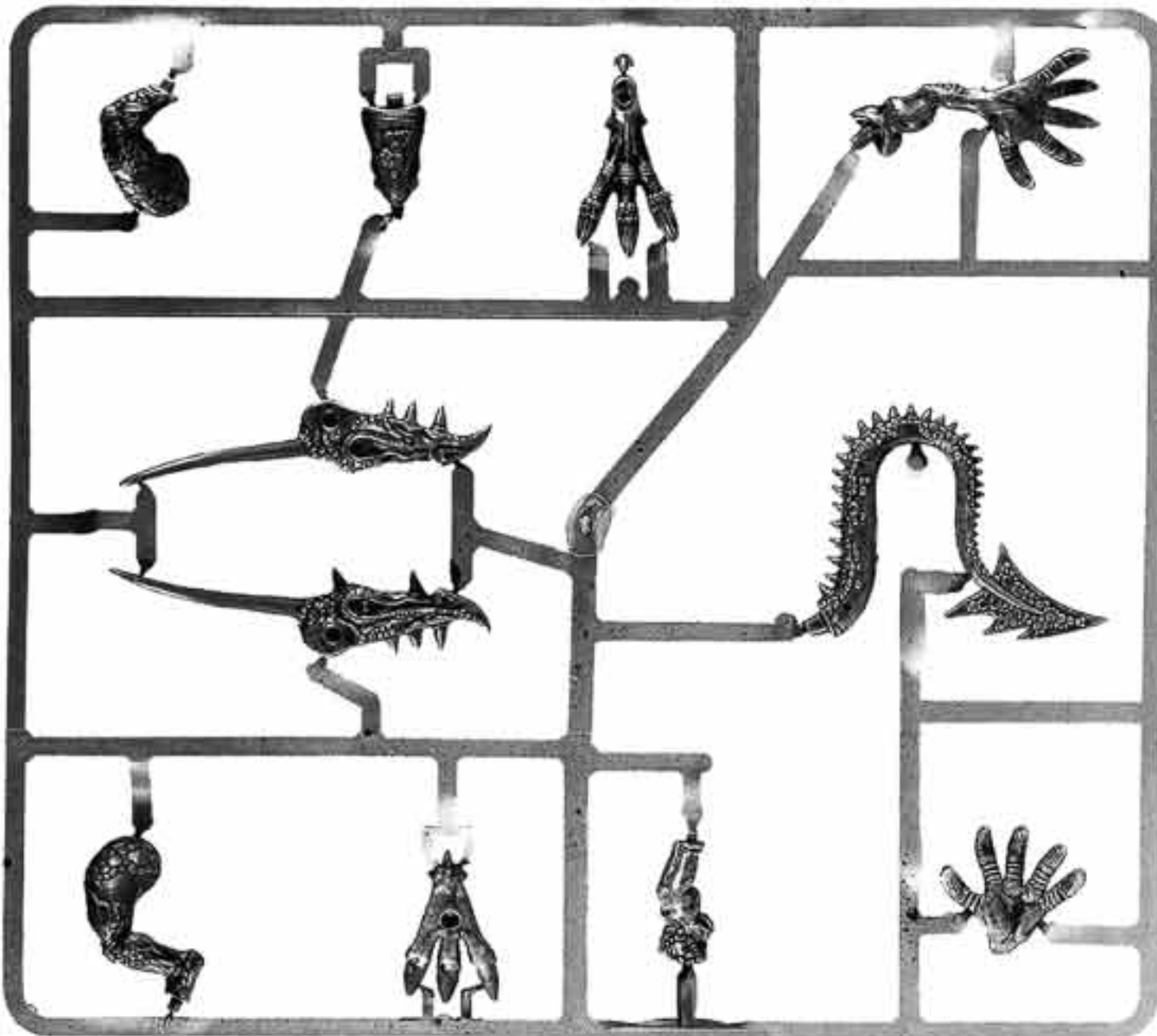

DRAGON LIMBS SPRUE (SHOWN 60% ACTUAL SIZE)
99389999077



**PRINCE IMRIK
DRAGON LEFT CLAW**
9947021010208



PRINCE IMRIK DRAGON RIGHT ARM
9947021010207



PRINCE IMRIK DRAGON HORNS
9947021010206



CORE UNITS



High Elf Warrior Regiment Box (16)
99120210003

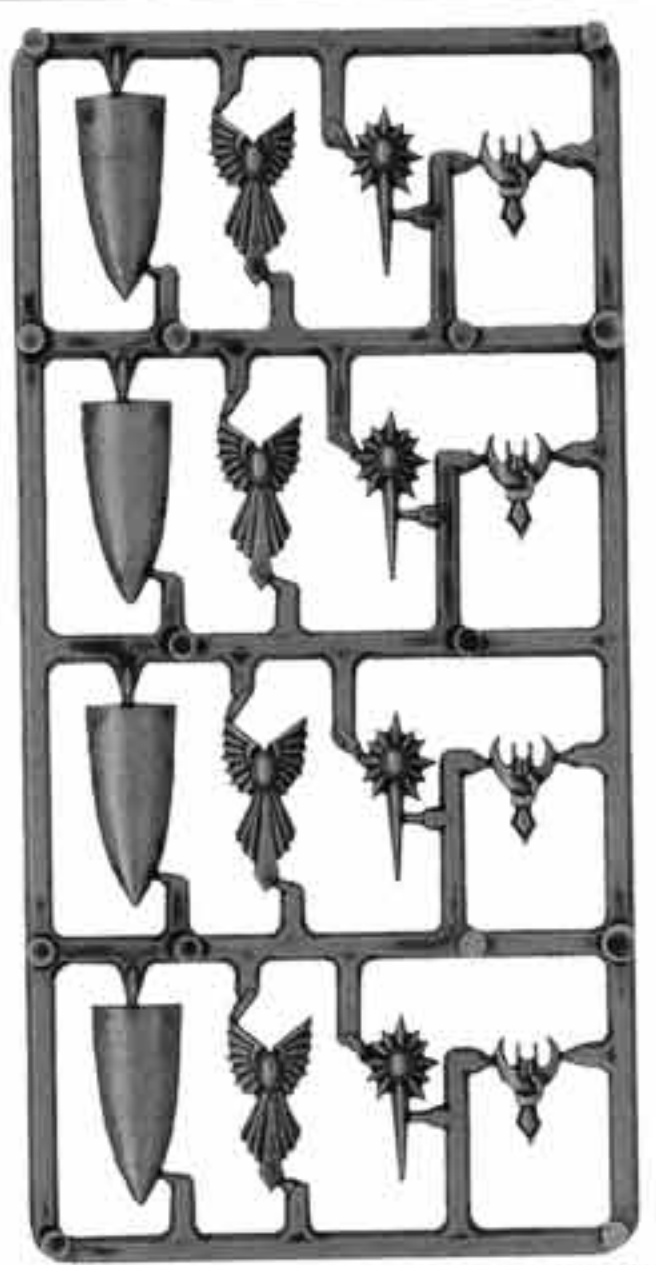

HIGH ELF SHIELD SPRUE (SHOWN 80% ACTUAL SIZE)
99360299008

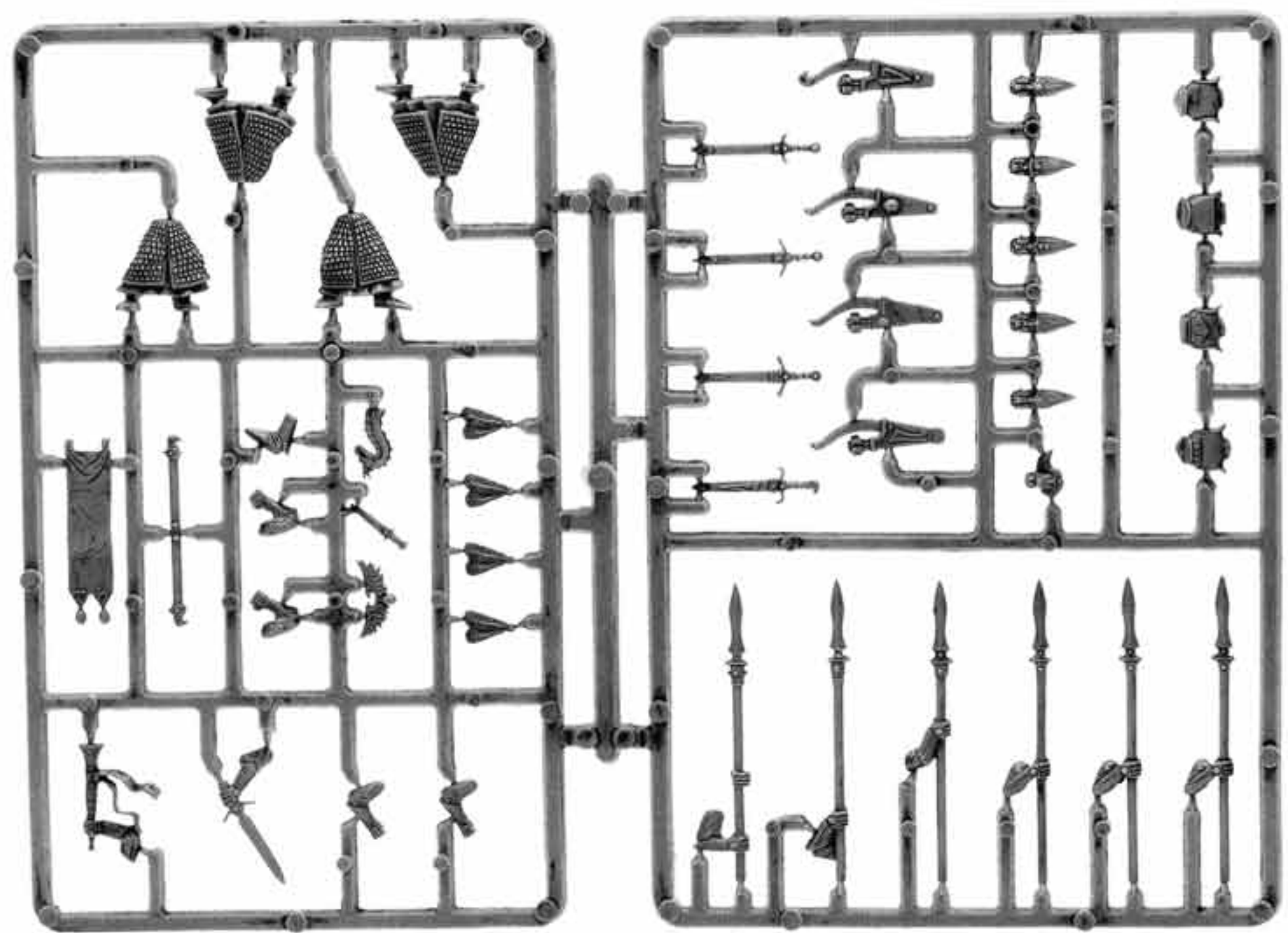

HIGH ELF SPEARMEN SPRUE (SHOWN AT 75% ACTUAL SIZE)
99380210001

CORE UNITS



BOW STRINGS



STEP 1

After painting the model, use a pin vise to drill a hole through the hand from the top to the bottom of the middle finger.

STEP 2

Feed light colored thread (grey or white) through the hole.



STEP 3

Add a small drop of super glue to the bottom of the bow and draw the thread across it to secure it. When it dries, trim off the extra glue and thread with clippers or a sharp hobby knife.

STEP 4

Add a drop of super glue to the top of the bow and draw the thread across to

secure it. Trim off the excess glue and thread when it dries. Paint a thin layer of varnish on the thread to keep it from fraying.

ARROWS



STEP 1

Drill a hole between the index and middle fingers of the model.

STEP 2

Cut a piece of fine wire (a small paper clip will work).

The wire should extend from the drawing hand of the model to just past the other hand holding the bow.

STEP 3

Dip one end of the arrow into super glue and insert it into the hole in the model's hand. Apply glue to the area where the arrow meets the other hand and secure it in place until it dries.

STEP 4

Paint the arrow any desired color and paint the tip with a light metal to represent the head. For extra detail, glue small paper strips to the end closest to the models hand to represent the arrow's fletchings.



High Elf Archer Regiment Box (16)
99120210004

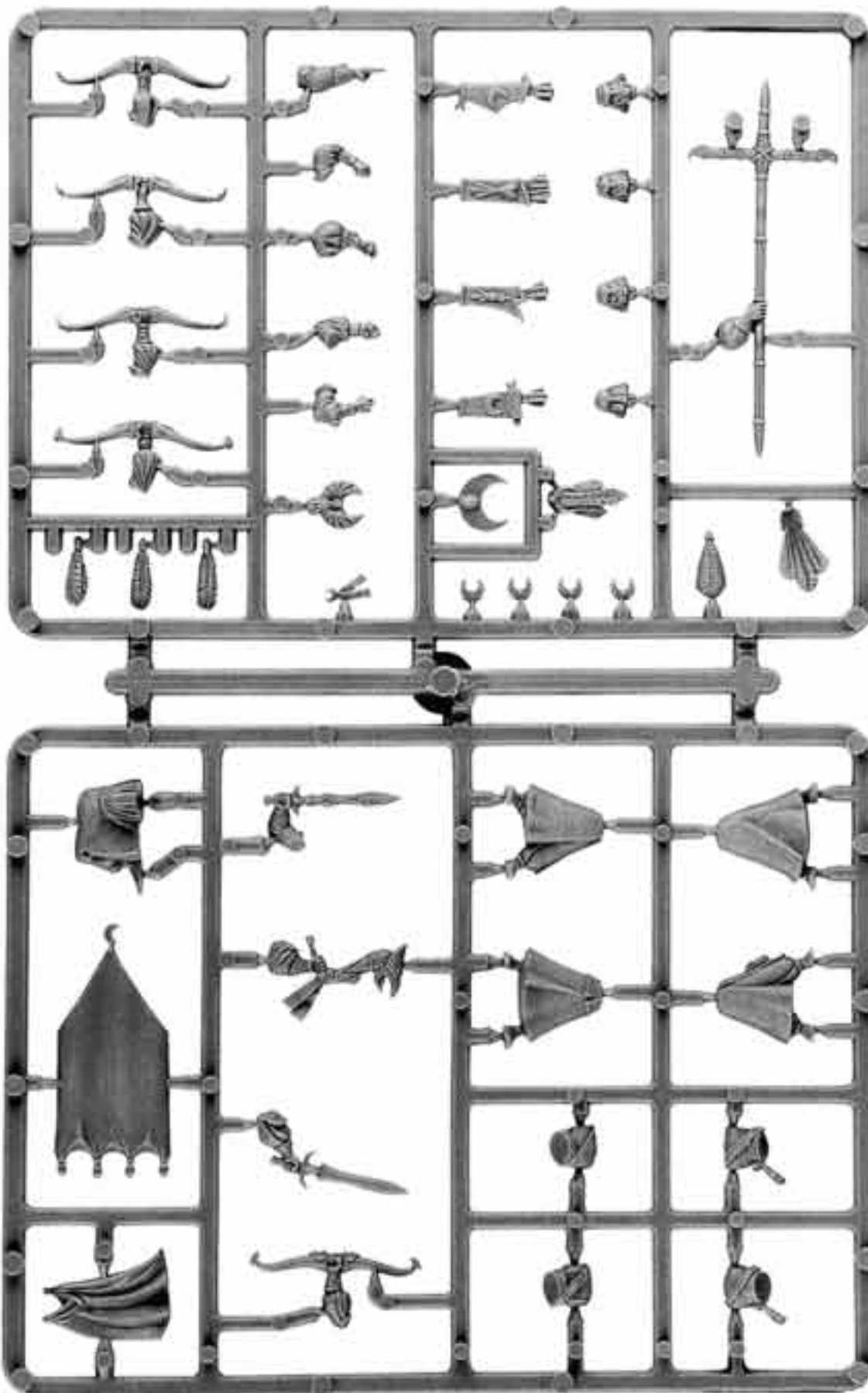

HIGH ELF ARCHERS SPRUE (SHOWN 70% ACTUAL SIZE)
99380210002

CORE UNITS

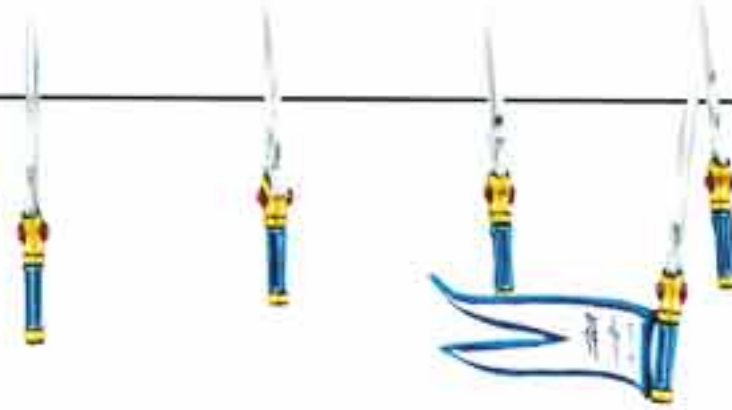

Silver Helms Regiment includes Barded Elf Steed Body and Head Sprues (99389999006 & 16) found in Lords & Heroes.

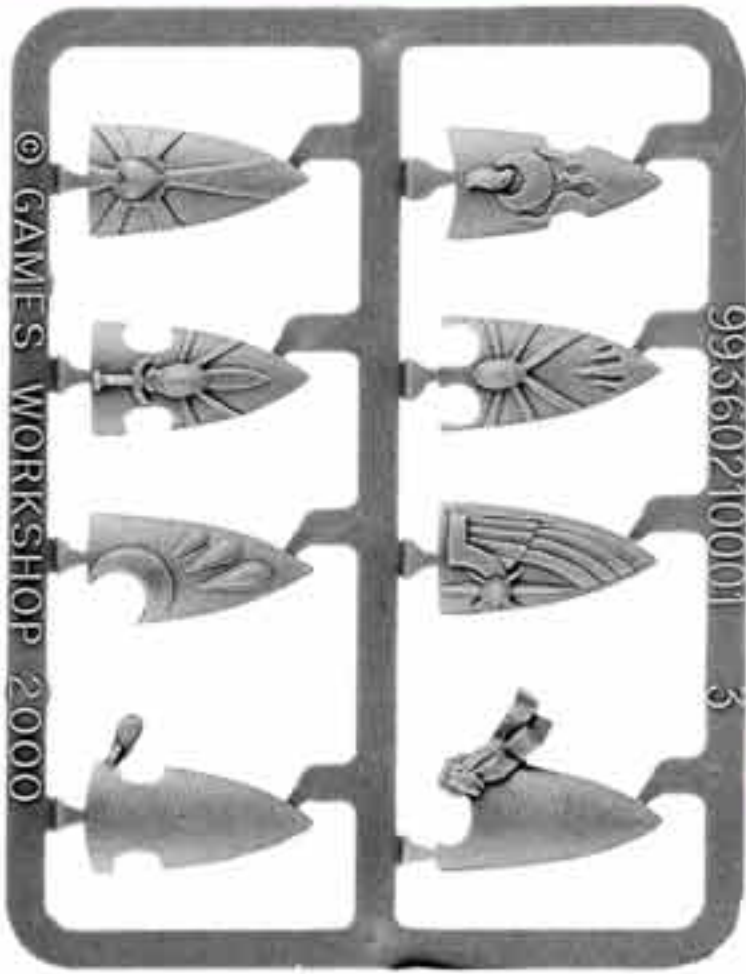

SILVER HELMS SHIELD SPRUE (SHOWN 85% ACT. SIZE)
99360210001



Silver Helms Regiment Box (8)
99120210005

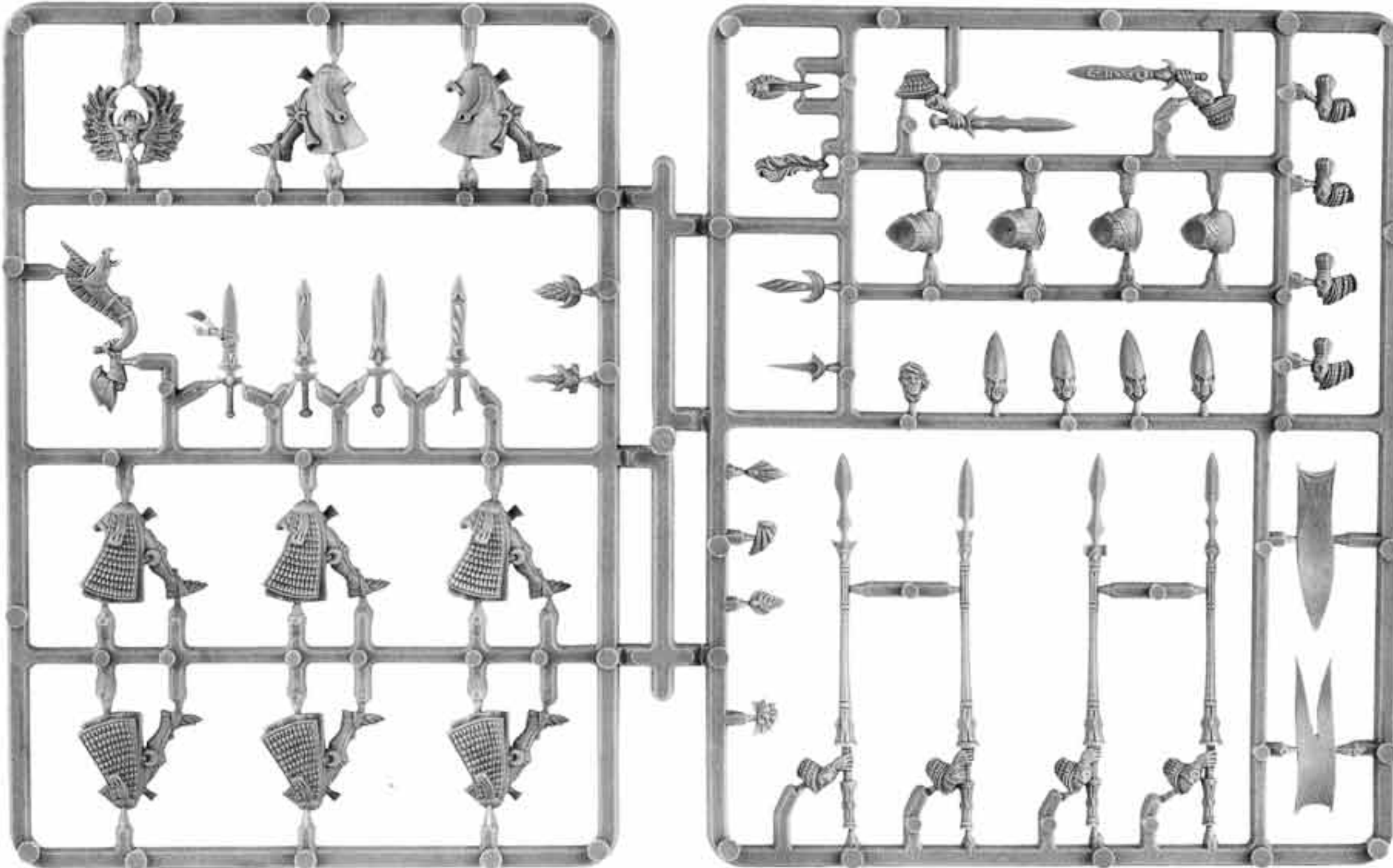

SILVER HELMS SPRUES (SHOWN 85% ACTUAL SIZE)
99380210003



SPECIAL UNITS

Dragon Prince models include the Barded Elf Steed Body and Head Sprues (99389999006 & 16) shown in Lords & Heroes.



DRAGON PRINCE SHIELD 1
9947021010307

DRAGON PRINCE SHIELD 2
9947021010308



DRAGON PRINCE HORSE HEAD 1
9947021010313

DRAGON PRINCE HORSE HEAD 2
9947021010314

Dragon Princes of Caledor Regiment Box (5)
99110210103

Dragon Prince of Caledor Blister (Random 1)
99060210108



DRAGON PRINCE STANDARD
9947021010310



DRAGON PRINCE BODY 1
9947021010301



DRAGON PRINCE BODY 2
9947021010302



DRAGON PRINCE BODY 3
9947021010303



DRAGON PRINCE BODY 4
9947021010304



DRAGON PRINCE COMMAND BODY
9947021010309



DRAGON PRINCE SWORD
9947021010311



DRAGON PRINCE HORN
9947021010312



DRAGON PRINCE LANCE 1
9947021010305



DRAGON PRINCE LANCE 2
9947021010306



SPECIAL UNITS

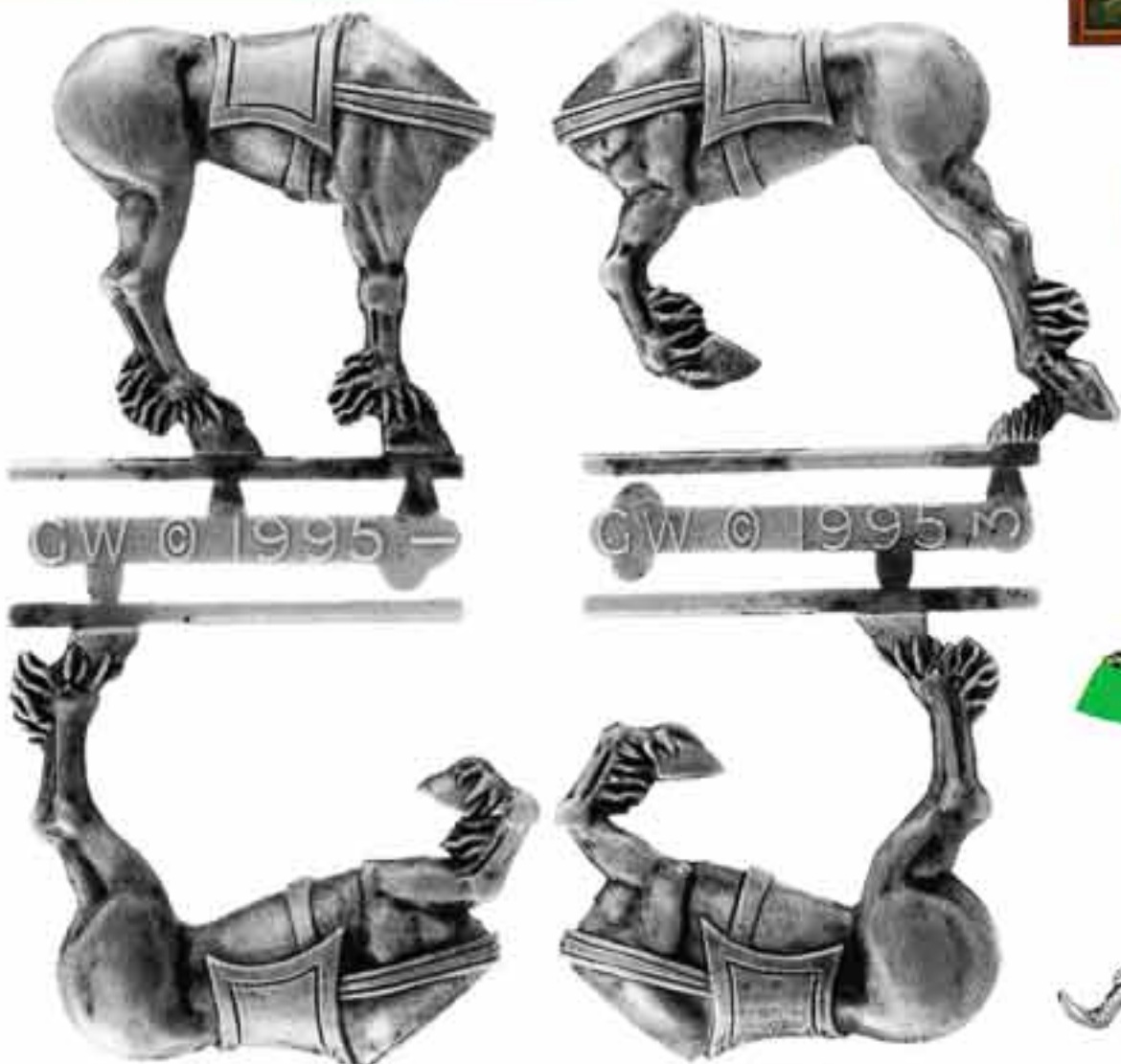

ELF STEED BODY SPRUE (RANDOM 1)
99389999005



Tiranoc Chariot Box (1)
99110210048



TIRANOC CHARIOT YOKE
9947021004809



ELF STEED HEAD SPRUE (RANDOM 1)
99389999015



TIRANOC CHARIOT BASE
9947021004803



TIRANOC CHARIOT HAFT
994721004808



TIRANOC CHARIOT SPEARMAN
9947021004801



TIRANOC CHARIOT BOWMAN
9947021004802



7-SPOKED WHEEL SPRUE
99389999001



TIRANOC CHARIOT FRONT
9947021004806



TIRANOC CHARIOT LEFT SIDE
9947021004804



TIRANOC CHARIOT RIGHT SIDE
9947021004805



TIRANOC CHARIOT ACCESSORY SPRUE
9947021004807

SPECIAL UNITS



Ellyrian Reaver Blister (Random 1)
99060210093

Ellyrian Reaver Command Blister (Random 1)
99060210104

Ellyrian Reaver models include the Elf Steed Body and Head Sprues (99389999005 & 15) shown on the opposite page.



ELLYRIAN REAVER STANDARD
9947021010404



ELLYRIAN REAVER BOW ARM SPRUE
9947021003510



ELLYRIAN REAVER TORSO 1
9947021002601



ELLYRIAN REAVER TORSO 2
9947021002602



ELLYRIAN REAVER COMMAND BODY
9947021010401



ELLYRIAN REAVER LEGS 1
9947021002603



ELLYRIAN REAVER LEGS 2
9947021002604



ELLYRIAN REAVER LEGS 3
9947021003207



ELLYRIAN REAVER SWORD ARM
9947021010403



ELLYRIAN REAVER HORN
9947021010402

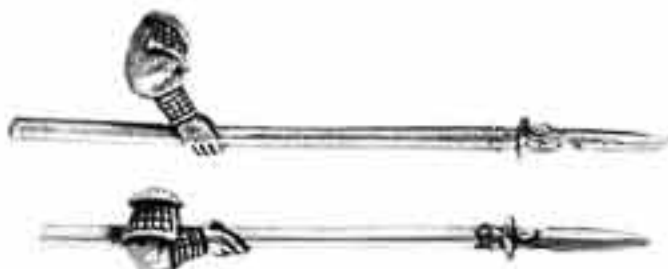

ELLYRIAN REAVER SPEAR SPRUE
9947021002606

ELVEN STEEDS

Spotting can distinguish the Elven Steeds from the other horse breeds in the Old World, like those of the Ellyrian Reaver's horses to the left. After painting a dark or medium basecoat on your Elven Steeds, you can add the spotting. We use a grey pallet which helps the white and blue of the Elves' clothing stand out from the coats of their steeds.

STEP 1

To begin, stipple Fortress Grey spots in a tight random pattern onto the steed's rump. To create the stipple effect, wipe most of the paint on the brush onto a tissue in a manner similar to drybrushing, and then dab, rather than wipe, on the selected areas.



STEP 2

Create a 50/50 mix of Fortress Grey and Skull White and stipple inside the Fortress Grey spots that you applied in the first step.



STEP 3

For the final step, stipple a very small amount of Skull White in the very center of the spots.



You can also use this process on the front of the horse near the shoulders and base of the neck. Your steeds are now ready for their riders and any final details you need to apply.

SPECIAL UNITS



SHADOW WARRIOR 1
9947021010001

SHADOW WARRIOR 2
9947021010002

SHADOW WARRIOR 3
9947021010003

SHADOW WARRIOR 4
9947021010004

SHADOW WARRIOR 5
9947021010005

SHADOW WARRIOR 6
9947021010006

Shadow Warriors Blister (Random 3)
99060210100

RARE UNITS

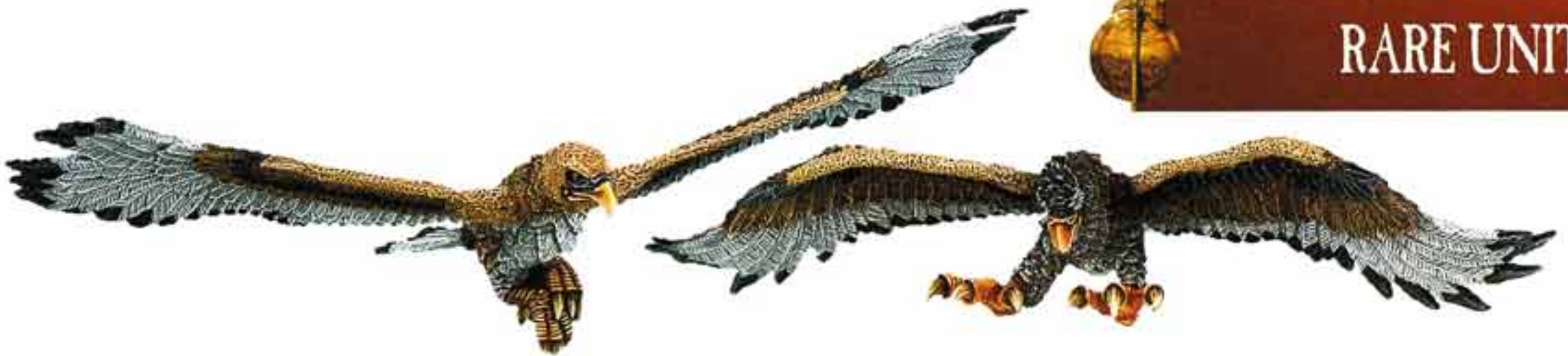

Great Eagle Blister (Random 1)
99060204008



GREAT EAGLE 1 TAIL
9947020400802



GREAT EAGLE 2 TAIL
9947020400804



GREAT EAGLE 1 HEAD
9947020400801



GREAT EAGLE 2 HEAD
9947020400803



GREAT EAGLE 3 HEAD
9947020400805



GREAT EAGLE LEFT WING 1
9947020400807



GREAT EAGLE RIGHT WING 1
9947020400808



GREAT EAGLE 3 TAIL
9947020400806



GREAT EAGLE LEFT WING 2
9947020400809



GREAT EAGLE RIGHT WING 2
9947020400810



RARE UNITS



ELVEN CLOTHING

Even with basic color schemes that are the same, using different base colors will drastically change the tone of the scheme. Here are a couple different highlighting variations you can try with your white cloaks.



GREY SHADES

Basecoat with Fortress Grey. Highlight with a 75/25 mix of Fortress Grey and Skull White. Next, highlight with a 50/50 mix of Fortress Grey and Skull White and then a 25/75 mix of Fortress Grey and Skull White. Finally, highlight with Skull White on its own.



BLUE SHADES

Basecoat with Ice Blue. Highlight with a 75/25 mix of Ice Blue and Skull White. Next, highlight with a 50/50 mix of Ice Blue and Skull White and then a 25/75 mix of Ice Blue and Skull White. Finally, highlight with Skull White on its own.



BROWN SHADES

Basecoat with Bleached Bone. Highlight with a 75/25 mix of Bleached Bone and Skull White. Next, highlight with a 50/50 mix of Bleached Bone and Skull White and then a 25/75 mix of Bleached Bone and Skull White. Finally, highlight with Skull White on its own.



Bolt Throwing Elf Box (1 Bolt Throwing Elf & 2 Crew)
99120210006

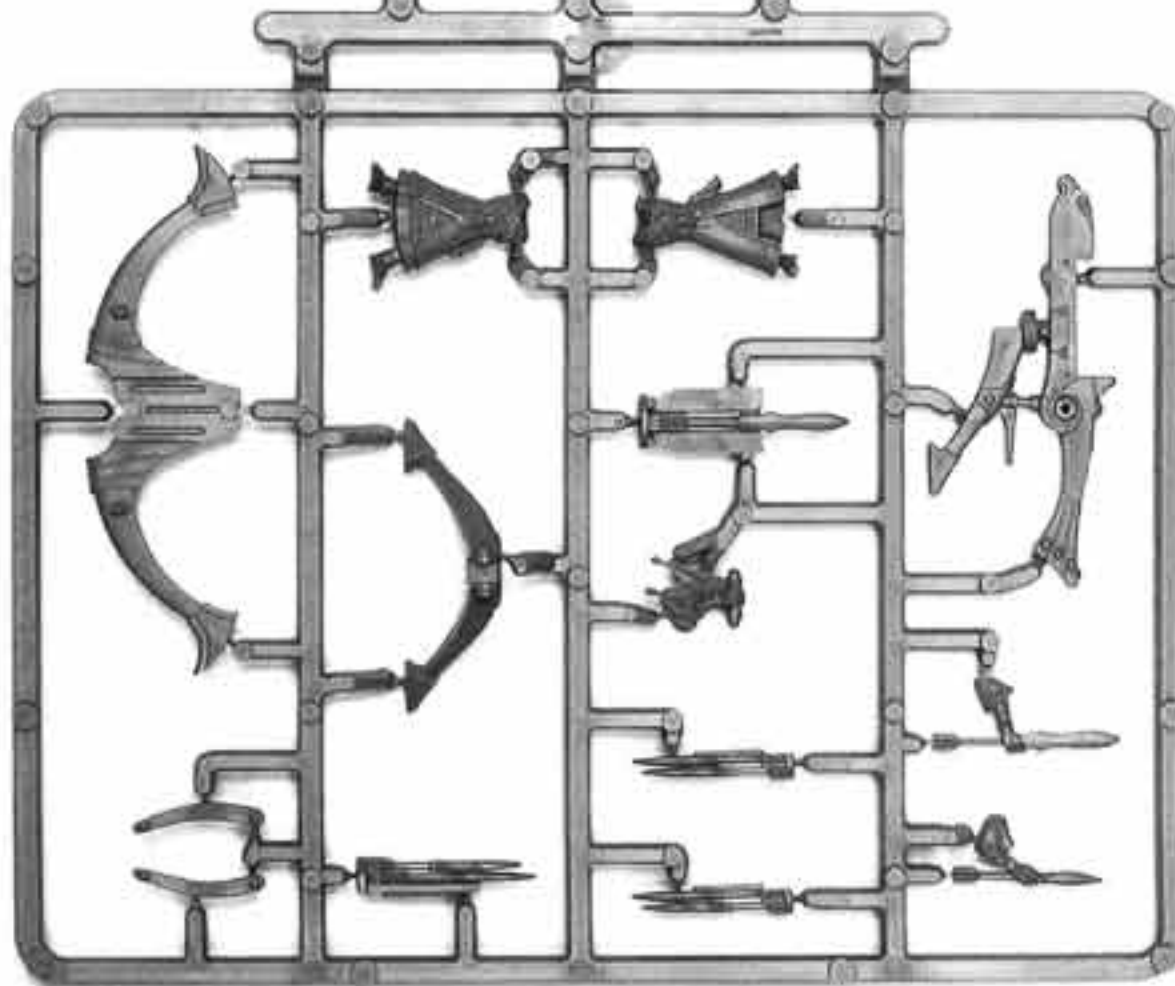
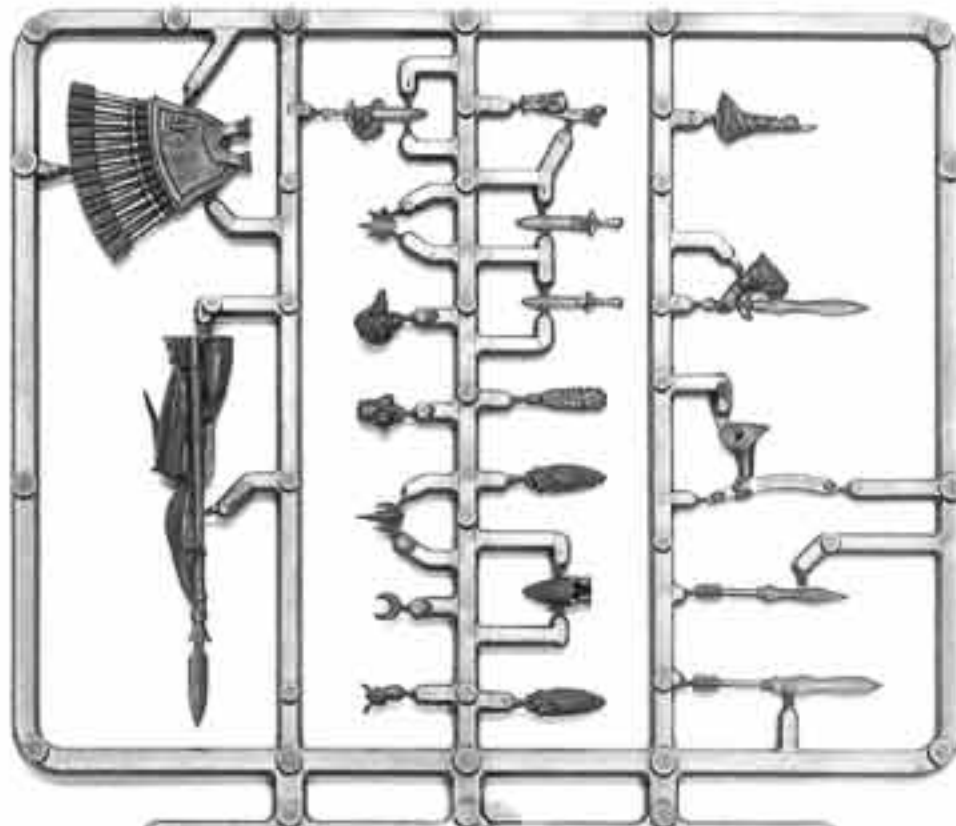

BOLT THROWER SPRUE (SHOWN 54% ACTUAL SIZE)
99380210005

RARE UNITS



Phoenix Guard Regiment Box (10) & Phoenix Guard Command Blister (3)
99110210105 99060210106



PHOENIX GUARD HALBERD
9947021010506



PHOENIX GUARD CHAMPION
9947021010601



PHOENIX GUARD DRUMMER
9947021010604



PHOENIX GUARD STANDARD BEARER
9947021010602



PHOENIX GUARD STANDARD
9947021010603



PHOENIX GUARD DRUM
9947021010605



PHOENIX GUARD 1
9947021010501



PHOENIX GUARD 2
9947021010502



PHOENIX GUARD 3
9947021010503



PHOENIX GUARD 4
9947021010504



PHOENIX GUARD 5
9947021010505

All minis are painted unpainted. Models, bats, and wings are all shown actual size unless otherwise noted. Contents may vary slightly from those shown.



RARE UNITS



White Lions of Chrace Regiment Box (10) & White Lions of Chrace Command Blister (3)
99110210040 99060210065



WHITE LION STANDARD TOP
9947021004502



WHITE LION STANDARD
9947021004501



WHITE LION 1
9947021004001



WHITE LION 2
9947021004002



WHITE LION 3
9947021004003



WHITE LION CHAMPION
9947021004401



These alternate bitz for the White Lions are available only via Special Offer.



WHITE LION 6
9947021004006



WHITE LION 4
9947021004004



WHITE LION 5
9947021004005



WHITE LION 7
9947021004007



WHITE LION MUSICIAN
9947021004503



WHITE LION 8
9947021004008

TACTICS



TIPS FOR WINNING WITH HIGH ELVES

- A. A High Elf army that combines the Banner of Sorcery, the Ring of Fury, and an Archmage (perhaps with a Mage or two for backup) can dominate the Magic Phase with a truly obscene number of Power Dice. High Magic (especially the Curse of Arrow Attraction) can then make a High Elf army very potent on the battlefield.
- B. A unit of Dragon Princes with the War Banner led by a Commander Battle Standard Bearer with the Battle Banner can be quite fearsome in combat. This unit can gain a bonus between +2 and +7 to combat resolution!
- C. High Elves armed with spears are a rather frightening prospect in close combat. Due to their martial training, High Elves with spears are able to fight in three ranks rather than two. Add another rank (or two) just in case and a command group, and you will have 4 points toward Combat Resolution before anyone fights! Lothorn Sea Guard are especially good with spears, as they are also armed with bows. If they can Stand & Shoot as a charge response and then use their spears in the ensuing combat, they will have a decided advantage.
- D. High Elves can field potent cavalry contingents or even entirely mounted forces. Silver Helms are extremely flexible, and their wide variety of options allows them to be used as small, cheap units to sneak around into the enemy's flanks or even as hard-hitting and well-armored shock cavalry. Dragon Princes are great heavy cavalry and, even with their Ithilmar barding, can still charge as far as 18", which all but ensures that they will be able to get maximum use of their lances. Reaver Knights are a great for frustrating your opponent. Armed with bows, they can use the *Fast Cavalry* rules to full effect and shoot in any direction, even after they have moved 18"! An especially devious tactic to use is to move them into a position outside of opposing units' charge arcs but close enough to prevent enemy march moves. Even if the Reaver Knights face away from the enemy, they can still shoot, thanks to the fact that they are *Fast Cavalry*!



COUNTERTACTICS

TIPS FOR FIGHTING AGAINST HIGH ELVES

- A. Judicious use of Dispel Dice and Dispel Scrolls can bring a difficult Magic Phase under control. Also, keep in mind that an army focused on the Magic Phase has not invested a great deal of points in rank-and-file troops. If you concentrate on taking down the army piece by piece, a magic-heavy enemy force should fold in combat. Of course, you can always send a flying unit, chariot, or character to target the Mages directly!
- B. This unit of Dragon Princes is indeed very dangerous. However, Dragon Princes are still only Toughness 3 models. Concentrate your shooting on this unit (especially war machines) and you should be able to sort them out quickly.
- C. Spear-armed units can be a thorny opponent to face, though they can only fight in three ranks to the front. Get around to the side or rear, and only those Spearmen in base contact with the enemy can fight. Also, if the charging unit has a Unit Strength of 5 or greater, it will force the Spearmen to take a *Panic* test and negate their rank bonus!
- D. High Elf cavalry can definitely cause some headaches, but in the end, they are just Elves. As long as you can weather that first round of Strength 5 attacks, you will then face a group of Elves with a Toughness and Strength of only 3. In addition, cavalry units rely on their maneuverability. If you can slow them down, charge them before they charge you, or get in around their flanks or rear, the horsemen will be at a decided disadvantage.

COLORS OF WAR



KEY

■ Top Box(es): Basecoat Colors & Ink Washes

■ Bottom Box(es): Highlights

■ Mixed Colors



*Snakebite Leather, Boltgun Metal
Bleached Bone, Chainmail*



*Snakebite Leather, Dwarf Bronze
Elf Flesh, Burnished Gold*



*Scab Red, Boltgun Metal
Blood Red, Chainmail*



*Boltgun Metal, Regal Blue
Chainmail, Regal Blue & Skull White*



*Warlock Purple, Brazen Brass
Tentacle Pink, Shining Gold*



*Boltgun Metal, Dwarf Bronze
Mithril Silver, Burnished Gold*



*Ultramarine Blue, Dwarf Bronze
Ice Blue, Burnished Gold*



*Red Gore, Dwarf Bronze
Blood Red, Burnished Gold*



*Enchanted Blue, Fortress Grey
Ice Blue, Skull White*



*Codex Grey, Scorched Brown
Fortress Grey, Desert Yellow*

ALTERNATE MODEL – SPECIAL Shadow Warriors COMPONENTS FOR 4 COMPLETE MODELS

99380210002 High Elf Archer Sprue
9947020709501 Nightmare Rider Cape

COMPLEXITY RATING



SHOWCASE



Above Left: Abe Peterka won third place at the 2004 Chicago Golden Demon painting competition with his High Elf Prince on Dragon (shown at 95% actual size).

Above Right: A High Elf Mage from Shawn Wagner's High Elf Army which won Best Appearance at the 2003 Vancouver GT.



Above: Earl Mark won third place with his High Elf Lothorn Sea Guard Regiment (shown at 90% actual size) at the 2004 Canadian Golden Demon painting competition.



Above: Here is one of Alan O'Bryan's amazing models from his Swordmaster regiment, which won at the 2002 Chicago Golden Demon competition.



ALTERNATE MODEL – SPECIAL Ellyrian Reavers COMPONENTS FOR 4 COMPLETE MODELS

- 99380210002 High Elf Archer Sprue
- 99380210003 Silver Helm Sprue
- 99389999005 Elf Steed Body
- 99389999015 Elf Steed Head

COMPLEXITY RATING



All measurements are supplied unmounted. Models, bits, and weapons are all shown at actual size unless otherwise noted. Contents may vary slightly from those shown.

HORDES OF CHAOS

For three weeks the army had marched, swelling in size as challengers were met, broken, and absorbed into the ranks. The edge of Troll Country drew near. The bleak and desolate lands were giving way to the wind-swept Eastern Steppes. The iron-will of Kalazak, Lord of Chaos, drove the army before him. All in-fighting and squabbling among different tribes or Chaos powers was quelled by his dark presence. No one knew what was beneath Kalazak's black armor, and no glint of eye or emotion could be seen from his horned helm. But the forces knew they were marching south, marching to war.

To the far north, past the desolations of Troll Country, lies the magic-swept land known as the Realm of Chaos. This cursed region is where the intense energy of Chaos warps and taints the surrounding northlands and the men and creatures who dwell there. It is here that the Chaos legions, both Mortal and Daemon, fight for the favors of the mighty gods.

Fighting Style

There are many variations and types of Chaos armies, but rest assured, none of them is friendly. Attack and devastation are always key ingredients for all the Chaos powers. Chaos armies can be composed of some of the most powerful close combat troops in the Warhammer game, and this fact, quite rightfully, causes much consternation for enemy generals. Whether a player chooses mostly Mortal followers of Chaos (Chaos Warriors, Knights, and Marauders) or a Daemonic host (with Daemons from any of the four powers), few opponents will relish meeting such troops in hand-to-hand fighting. However, simply attacking with all-out savagery, even with some of the most ferocious fighters in the game, rarely wins the battle against a knowledgeable foe. Using coordinated attacks and supporting units can ensure that the superior Chaos troops can carry home the attack. Horrible Spawn can pin down the foe. Fast troops like Marauder Horsemen and Hounds of Chaos can threaten enemy flanks, and magic can soften up the enemy before the main attacks begin.

Collecting a Hordes of Chaos Army

Collecting a Chaos army is easy and fun, and there are a wide variety of troops to choose from. We always suggest starting an army with a few Core units. However, to start your Chaos force, you have to decide on a leader. A Mortal General (a Chaos Lord or Exalted Sorcerer) may choose any of the Mortal forces as Core troops but treats Daemons as Special choices. A Daemon General (a Greater Daemon, Daemon Prince, or Exalted

Daemon) may select any Daemonic units as Core choices and any of the Mortal followers as Special. Chaos Warriors are a great place to start. They are powerful and paint up quickly, allowing players to get a force together in a hurry.

When a player expands a Chaos army, he or she has a huge number of choices to make. In fact, no army gives players as much choice as Chaos: Daemons of different powers, Spawn, powerful Chaos Knights, Chariots, Marauders, and more. Up to one unit of Chaos Knights or Chaos Warriors may be upgraded to a unit of Chosen. These fiendish troops are favored by the Gods and gain an extra Attack and Chaos Armor. Best of all, all the troops from the Beasts of Chaos army list may be included as Special or Rare choices in a Hordes of Chaos army list. Thus, the tactical options of the Chaos army, as well as the painting and modeling variety, are second to none.

Darren Watson's Chaos Warriors of Khorne won second place in the Warhammer Regiment category at the 2004 Canada Golden Demon painting competition.

Even More Chaos!

In addition to everything in the Hordes of Chaos army list, Chaos players can mix and match troops and heroes from the Beasts of Chaos army list. Thus, it is possible to add a unit of Beastmen to screen your Chaos Knights or a solid force of Dragon Ogres or a Chaos Giant to beef up your army.

Whether a troop is listed as Core or Special depends on what kind of General (Beast, Mortal, or Daemonic) a player is using. Consult the Army books for a full description. Now, go out and conquer!



Archaon's Horde launches another assault on the fertile lands of the Empire.



GETTING STARTED

The 112-page Hordes of Chaos book contains all of the rules for building an army from the Chaos Wastes. The Storm of Chaos book contains special rules for new Chaos troops as well as narrative scenarios and a history for the Storm of Chaos campaign.

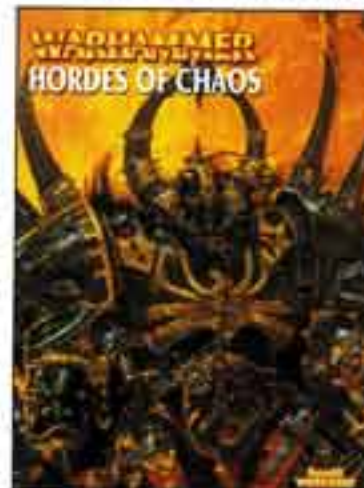

Warhammer Armies:
Hordes of Chaos
60030201002



Warhammer:
Storm of Chaos
60030201004

The best place to begin amassing your Chaos Horde is with either or both of these plastic regiment boxed sets. The Warriors of Chaos boxed set contains parts to build 12 Warriors, while the Marauders of Chaos box contains enough for 16 rough and ready Marauders as well as a Chaos mutations sprue to add suitably chaotic modifications to your troops. Each box contains a command sprue.



Warriors of Chaos
Regiment (12)
99120201006



Marauders of Chaos
Regiment (16)
99120201003

Right: A fully assembled regiment of Chaos Marauders with command.

Below: A fully assembled regiment of Chaos Warriors complete with command.



Below: Just by using a different color scheme, you can make your Chaos Warriors followers of any of the different Chaos gods.



LORDS & HEROES



ARCHAON BODY
9947020112502



ARCHAON HEAD & SWORD SPRUE
9947020112501



Archaon, Lord of the End Times Box (1)
99110201125



ARCHAON HORSE HEAD
9947020112507



ARCHAON HORSE TAIL
9947020112506



ARCHAON SHIELD & HAND SPRUE
9947020112503



ARCHAON HORSE LEFT SIDE
9947020112504



ARCHAON HORSE RIGHT SIDE
9947020112505



ARCHAON BASE
9947020112508



Crom the Conqueror Blister (1)
99060201145



CROM HEAD & SWORD SPRUE
9947020114501



CROM BODY
9947020114503



CROM SHIELD
9947020114502



LORDS & HEROES



Galrauch, First of the Chaos Dragons Box (1)
99110201141



GALRAUCH HEAD 1
9947020114101



GALRAUCH HEAD 2
9947020114102



GALRAUCH TORSO
9947020114103



GALRAUCH LEFT WING
9947020114106



GALRAUCH TAIL
9947020114107



GALRAUCH RIGHT WING
9947020114105



GALRAUCH LEGS
9947020114104



GALRAUCH SPIKE SPRUE 2
9947020114111



GALRAUCH SPIKE SPRUE 1
9947020114110



GALRAUCH RIGHT ARM
9947020114109



GALRAUCH CLAWS
9947020114108



LORDS & HEROES



BE'LAKOR SWORD
9947020115703



BE'LAKOR LEFT WING
9947020115709



BE'LAKOR RIGHT WING
9947020115710



BE'LAKOR TORSO
9947020115702



BE'LAKOR LEFT LEG
9947020115706



BE'LAKOR RIGHT LEG
9947020115707



BE'LAKOR TAIL
9947020115708



BE'LAKOR CLOTH
9947020115705



BE'LAKOR HEAD
9947020115701



BE'LAKOR LEFT ARM
9947020115704



Mounted Khorne Lord Box (1)
99110201133



KHORNE LORD HEAD
9947020113302



KHORNE LORD HORSE HEAD
9947020113304



KHORNE LORD HORSE TAIL
9947020113307



KHORNE LORD BODY
9947020113301



KHORNE LORD SWORD & SHIELD SPRUE
9947020113303



KHORNE LORD RIGHT SIDE
9947020113305



KHORNE LORD LEFT SIDE
9947020113306

All miniatures are supplied unpainted. Models, bits, and sprues are all shown actual size unless otherwise noted. Contents may vary slightly from those shown.

LORDS & HEROES



Lord of Slaanesh on Steed Box (1)
99110201139



LORD OF SLAANESH HALBERD
9947020113903



LORD OF SLAANESH BANNER
9947020113902



LORD OF SLAANESH STEED TAIL SPRUE
9947020113912



LORD OF SLAANESH STEED TAIL BOTTOM
9947020113910



LORD OF SLAANESH STEED BODY
9947020113908



LORD OF SLAANESH STEED TAIL TOP
9947020113911



LORD OF SLAANESH STEED HEAD
9947020113909



LORD OF SLAANESH HEAD
9947020113901



LORD OF SLAANESH BODY
9947020113904



LORD OF SLAANESH SHIELD
9947020113907



LORD OF SLAANESH LEFT LEG
9947020113905



LORD OF SLAANESH RIGHT LEG
9947020113906



LORD OF NURGLE STEED RIGHT SIDE
9947020113704



LORD OF NURGLE WEAPON SPRUE
9947020113703



LORD OF NURGLE STEED LEFT SIDE
9947020113705



LORD OF NURGLE SIGN POST
9947020113706



LORD OF NURGLE TORSO
9947020113702



LORD OF NURGLE HEAD SPRUE
9947020113701



Lord of Nurgle on Steed Box (1)
99110201137



LORDS & HEROES



Lord of Tzeentch Box (1)
99110201142



LORD OF TZEENTCH HEAD
9947020114202



LORD OF TZEENTCH BODY
9947020114201



LORD OF TZEENTCH HALBERD
9947020114203



SMALL FLYING STEMS
99379999003

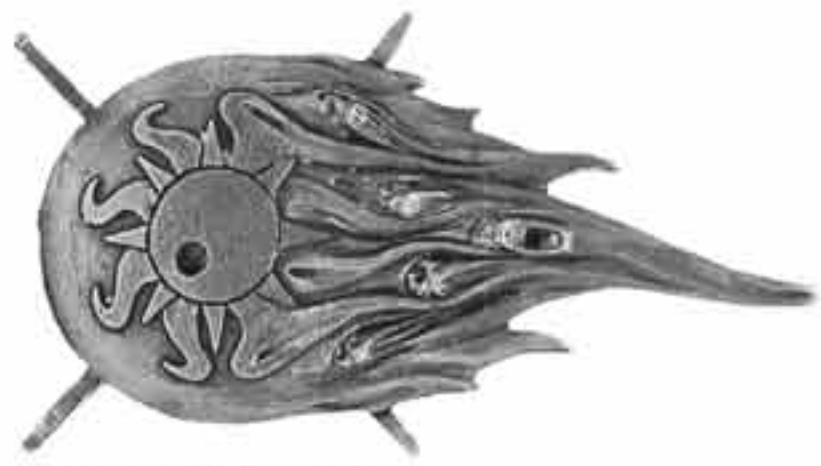

LORD OF TZEENTCH DISC
9947020114204



LORD OF TZEENTCH BLADES
9947020114205



Chaos Sorcerer Blister (2)
99060201130



SORCERER HEAD
9947020113002

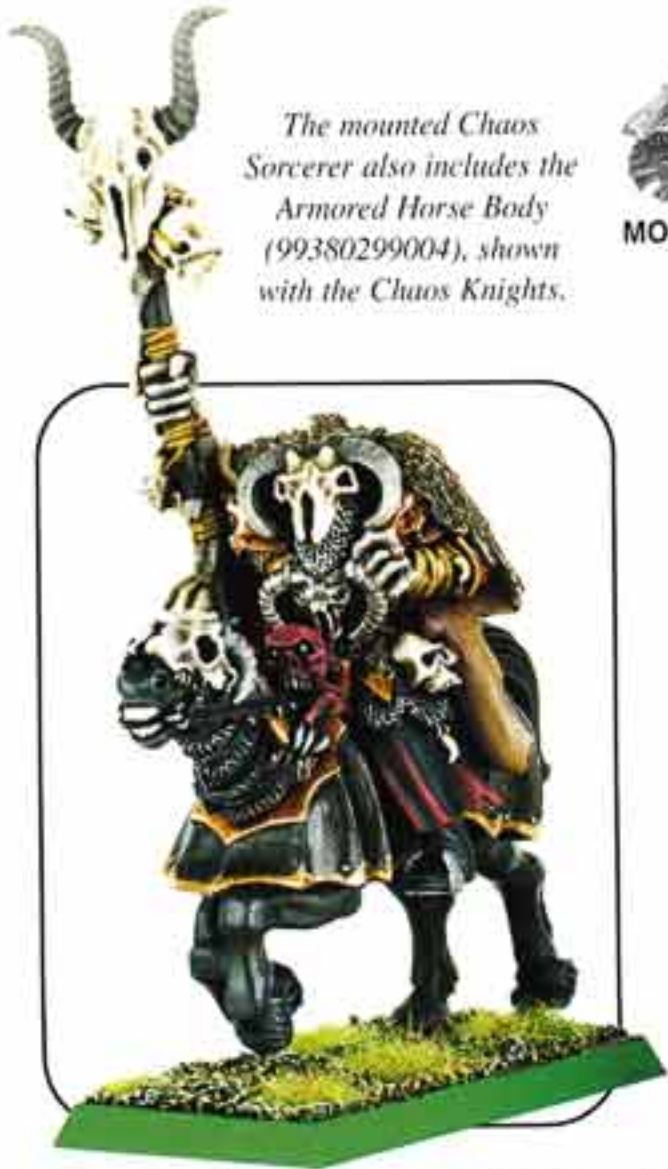

Mounted Chaos Sorcerer Blister (1)
99060201140

The mounted Chaos Sorcerer also includes the Armored Horse Body (99380299004), shown with the Chaos Knights.



MOUNTED SORCERER HORSE HEAD
9947020114002



CHAOS KNIGHT HORSE TAIL
9947020112617



SORCERER BODY
9947020113001



SORCERER FAMILIAR
9947020113004



SORCERER STAFF
9947020113003



SORCERER BODY
9947020114001



LORDS & HEROES



Champion of Chaos Undivided Blister (1)
99060201127



CHAMPION OF CHAOS UNDIVIDED BODY
9947020112701



CHAMPION OF CHAOS UNDIVIDED SPRUE
9947020112702



Champion of Tzeentch Blister (1)
99060201143



CHAMPION OF TZEENTCH STAFF
9947020114302



CHAMPION OF TZEENTCH BODY
9947020114301



CHAMPION OF TZEENTCH FAMILIAR
9947020114303



Champion of Nurgle Blister (1)
99060201136



CHAMPION OF NURGLE BODY
9947020113601



CHAMPION OF NURGLE HEAD & SWORD
9947020113602

PAINTING A CHAMPION OF CHAOS

After applying an undercoat of Chaos Black, paint the Champion with a mix of two parts Chaos Black to one part Regal Blue. Add small amounts of Fortress Grey to this mix for the highlight stages.

Use Brazen Brass to paint the trim and helmet.

Highlight these areas with Shining Gold and then Mithril Silver mixed with Shining Gold. Wash these sections with Chestnut Ink and then again with thinned Brown Ink.



Paint the horns and skulls with a basecoat mix of equal parts Snakebite Leather and Chaos Black. Add Skull White to this mix for the highlights, and use pure Skull White for the final highlight.



Paint the fur cloak with a basecoat of Snakebite Leather. Add Skull White to Snakebite Leather and then apply this mix toward the outer edges of the cloak.



Give the cloak a basecoat of Scab Red and highlight with Red Gore and then Blood Red. Mix Blood Red with Fiery Orange for the penultimate highlight. Add a small amount of Skull White to this mix for the final highlight and then wash the whole cloak with thinned Chestnut Ink.



Use a basecoat of Bestial Brown to paint the flayed skin and pouches. Add an equal quantity of Dwarf Flesh to this color for the first highlight stage. For the final highlight stages, add small amounts of Bleached Bone.

Paint the metallic sections with a basecoat of Boltgun Metal and then highlight with Chainmail and then Mithril Silver. Apply shading with a wash of thinned Brown Ink.

Mix Red Gore and Red Ink for the blood and then varnish the blood stains once the model is finished.

Texture the base of the model by attaching sand and static grass with white glue.



LORDS & HEROES



**Champion of
Slaanesh Blister (1)**
99060201138



**CHAMPION OF
SLAANESH BODY**
9947020113801



**Champion of Khorne
Blister (1)**
99060201134



**CHAMPION OF
KHORNE HEAD**
9947020113402



**CHAMPION OF
KHORNE BODY**
9947020113401



**CHAMPION OF
SLAANESH
SHIELD**
9947020113804



**CHAMPION OF
SLAANESH
HEAD**
9947020113802



**CHAMPION OF
SLAANESH SWORD**
9947020113803



**CHAMPION OF
KHORNE BASE**
9947020113404



CHAMPION OF KHORNE AXE
9947020113403





The Chariot of Chaos also includes the Armored Horse Body (99380299004), shown with the Chaos Knights.



Chariot of Chaos Box (1)
99110201122



CHAOS CHARIOT LEFT FAIRING
9947020107307



CHAOS CHARIOT YOKE
9947020107309



CHAOS CHARIOT RIGHT FAIRING
9947020107306



CHAOS CHARIOT SCYTHE
9947020107311



CHAOS CHARIOT BASE
9947020107308



CHAOS CHARIOT HAFT
9947020107304



CHAOS CHARIOT WHEEL
9947020107310



CHAOS CHARIOT FRONT FAIRING
9947020107305



CHAOS KNIGHT STEED HEAD 2
9947020107702



WARRIOR CREWMAN W/ AXE
9947020107301



WARRIOR CREWMAN W/ WHIP
9947020107302



WARRIOR CREWMAN WHIP ARM
9947020107303

MORTAL UNITS

PAINTING CHAOS MARAUDERS

Undercoat your Marauder with Chaos Black Spray Primer.

Paint the Marauder's skin with a basecoat of Vermin Fur. Give all the flesh areas a wash of Brown Ink to create shading. Once the ink dries, highlight the skin with Vermin Fur again, then Bronzed Flesh, and finally Bleached Bone. Add a final light highlight of Skull White to add definition to the muscles and most raised areas.



Paint leather areas such as the breeches, straps, boots, and wrist bands with a basecoat of Scorched Brown. Apply a watered-down wash of Black Ink to the recesses of these areas. Touch up any areas where the wash overlapped with Scorched Brown. Finally, apply a highlight of Snakebite Leather to the edges and raised areas near creases.

Apply a basecoat of Boltgun Metal to all of the different metallic areas. Apply a wash of thinned Chaos Black Ink to the rivets and recessed areas of the metallic surfaces. Touch up with Boltgun Metal where the Black Ink overlaps. Give all of the metal areas a final highlight of Mithril Silver.



Drybrush the fur on the back of the legs with Vomit Brown. Drybrush Codex Grey on the haft of the flail to bring out the woodgrain. Highlight any remaining black areas with Codex Grey.



Finish off the base by attaching sand with white glue. Once the sand and glue dries, drybrush the sand with Codex Grey and then Bleached Bone. If you like, you can attach small clumps of static grass to your base with white glue.



MORTAL UNITS



Below: Two examples of Warriors of Chaos painted to show their allegiance to specific Chaos gods. On the left is a follower of Slaanesh, and on the right a follower of Tzeentch.



Warriors of Chaos Regiment Box (12)
99120201006

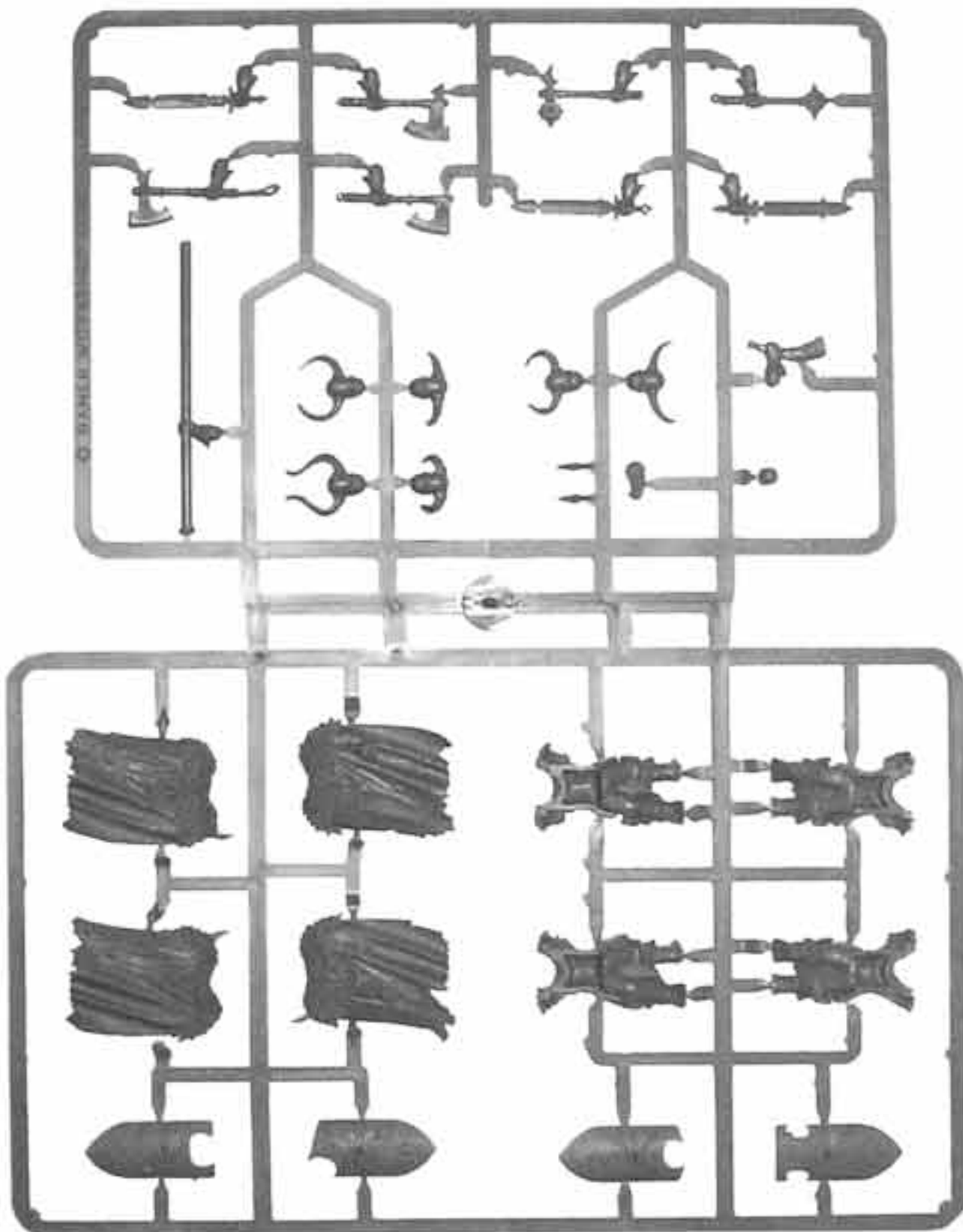

CHAOS WARRIORS SPRUE (SHOWN 55% ACTUAL SIZE)
99380201014

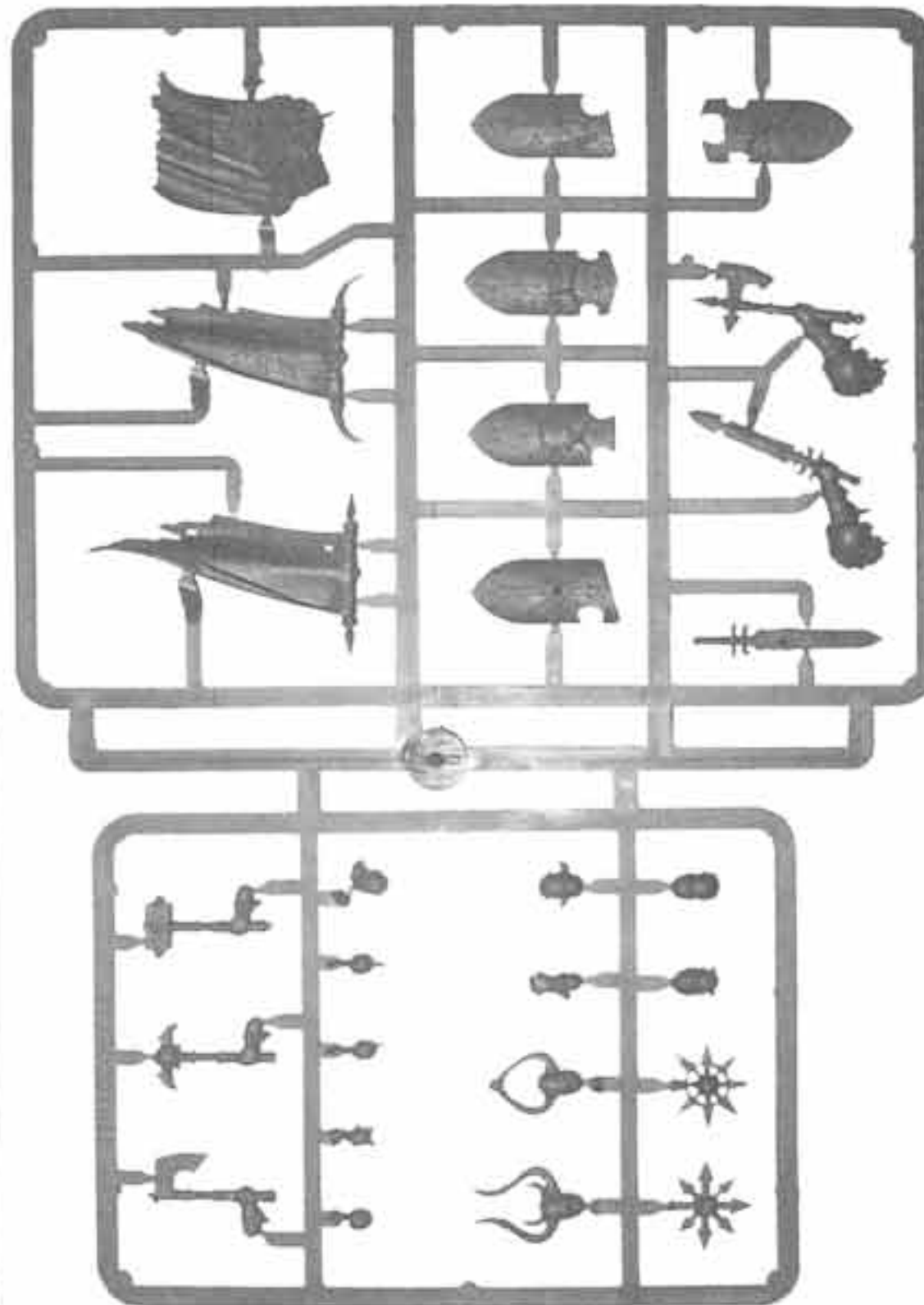

CHAOS UNDIVIDED ACCESSORY SPRUE (SHOWN 60% ACTUAL SIZE)
99380201015



MORTAL UNITS



Marauders of Chaos Regiment Box (16)
99120201003



MARAUDER SHIELD SPRUE
(SHOWN 90% ACTUAL SIZE)
99360201002

Marauders can be assembled with hand weapons (as shown on the regiment) or with flails (as shown on the single model).

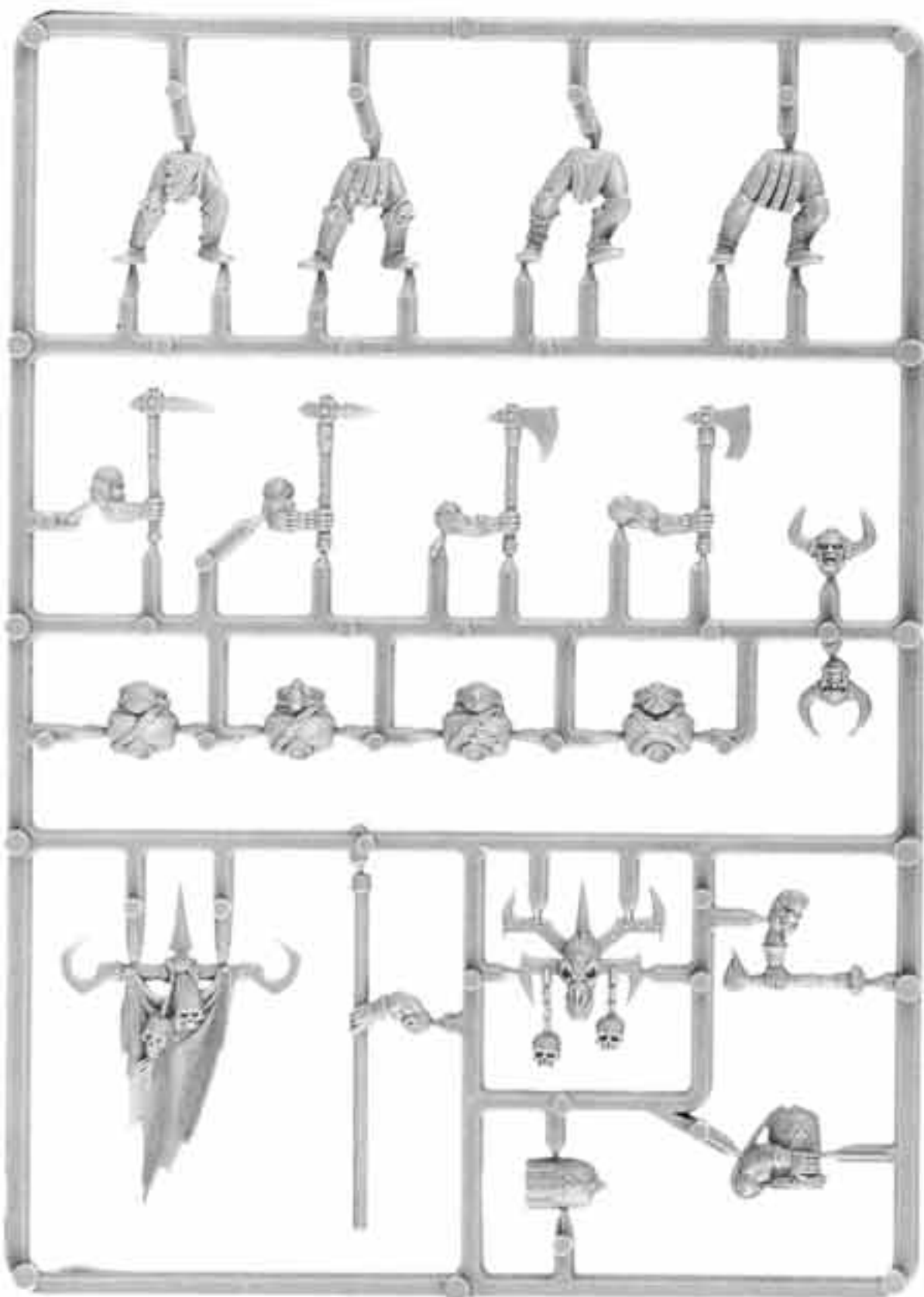

MARAUDER SPRUE A (SHOWN 70% ACTUAL SIZE)
99380201010

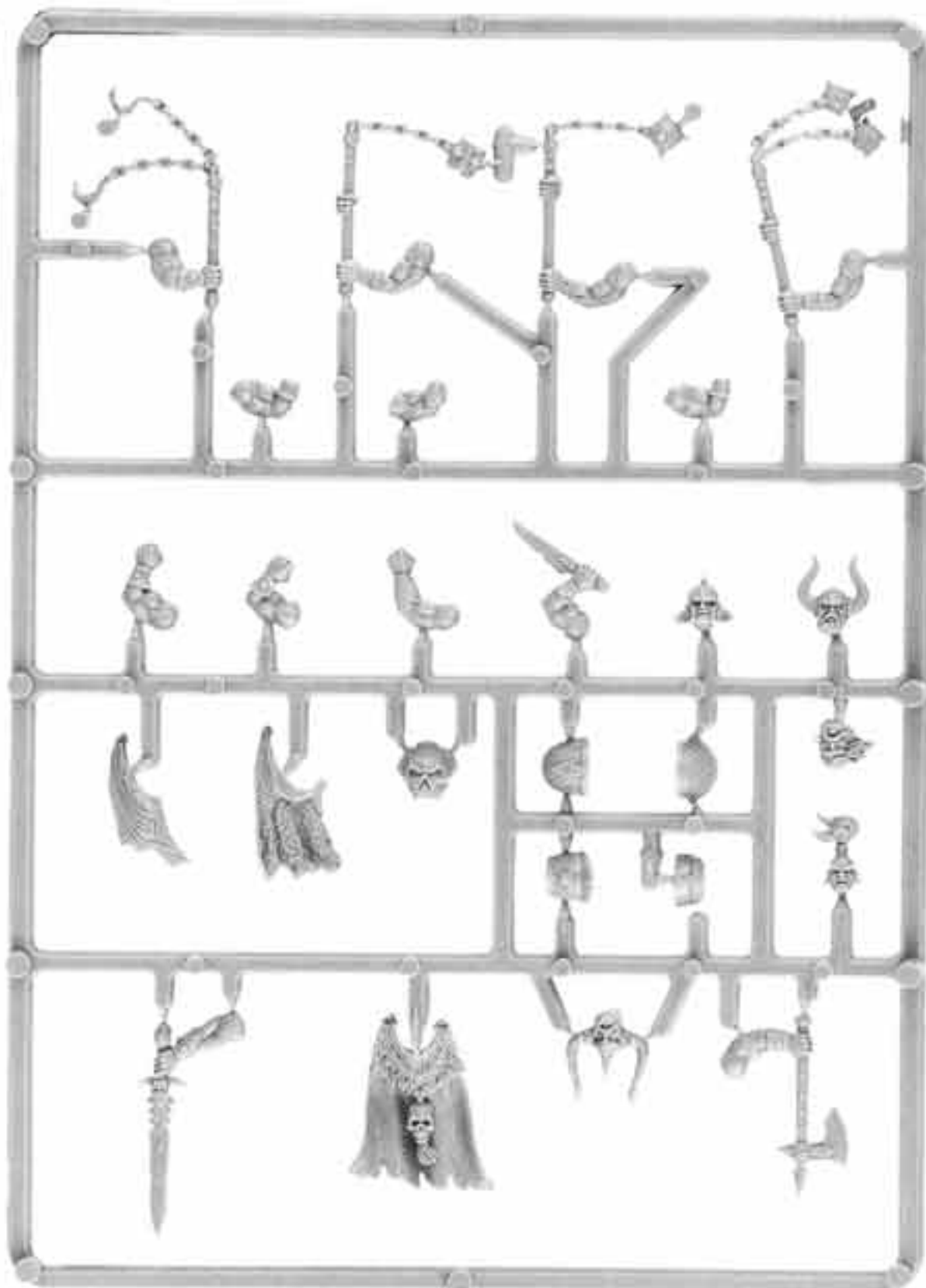

MARAUDER SPRUE B (SHOWN 70% ACTUAL SIZE)
99380201011

MORTAL UNITS



**CHAOS KNIGHT
CHAMPION BODY**
9947020112618



**CHAOS KNIGHT
CHAMPION
HORSE HEAD**
9947020112622



**CHAOS KNIGHT
STANDARD**
9947020112621



**Knights of Chaos
Regiment Box (5)**
99110201126

**Knights of Chaos
Blister (Random 1)**
99060201129



**CHAOS KNIGHT
CHAMPION SWORD**
9947020112619



**CHAOS
KNIGHT HORN**
9947020112620



**CHAOS KNIGHT
AXE 1**
9947020112606



**CHAOS KNIGHT
AXE 2**
9947020112605



**CHAOS KNIGHT
HAMMER**
9947020112607



**CHAOS KNIGHT
SWORD**
9947020112608



**CHAOS KNIGHT
HORSE TAIL**
9947020112617



**CHAOS KNIGHT
HEAD 1**
9947020112613



**CHAOS KNIGHT
HEAD 2**
9947020112614



**CHAOS KNIGHT
BODY 1**
9947020112601



**CHAOS KNIGHT
BODY 2**
9947020112602



**CHAOS KNIGHT
BODY 3**
9947020112603



**CHAOS KNIGHT
BODY 4**
9947020112604



**CHAOS KNIGHT
SHIELD 3**
9947020112615



**CHAOS KNIGHT
HEAD 4**
9947020112616

The Knights of Chaos Regiment boxed set and the Knight of Chaos blister include the body portion of the Armored Horse Sprue (99380299004). The head and tail sprue is shown elsewhere in this catalog.



**CHAOS KNIGHT
SHIELD 1**
9947020112609



**CHAOS KNIGHT
SHIELD 2**
9947020112610



**CHAOS KNIGHT
SHIELD 3**
9947020112611



**CHAOS KNIGHT
SHIELD 4**
9947020112612



ARMORED HORSE SPRUE (RANDOM 1 BODY) (SHOWN 60% ACTUAL SIZE)
99380299004



MORTAL UNITS

The Champion, Musician, and Standard Bearer bits are available only in the boxed regiment. They are not part of the random assortment for the Marauder Horseman blister pack.



Marauder Horsemen Regiment Box (5) 99110201132

 The bits in this box are available only via special offer.



MARAUDER HORSEMEN CHAMPION BODY
9947020113114



MARAUDER HORSEMEN STANDARD
9947020113118



MARAUDER HORSEMEN BODY 5
9947020113105



MARAUDER HORSEMEN BODY 1
9947020113101



MARAUDER HORSEMEN BODY 2
9947020113102



MARAUDER HORSEMEN BODY 3
9947020113103



MARAUDER HORSEMEN BODY 4
9947020113104



MARAUDER HORSEMEN CHAMPION AXE
9947020113115



MARAUDER HORSEMEN COMMAND HORN
9947020113116



MARAUDER HORSEMEN COMMAND HORSE HEAD
9947020113119



MARAUDER HORSEMEN CHAMPION SHIELD
9947020113117



MARAUDER HORSEMEN SPEAR & SHIELD 1
9947020113106



MARAUDER HORSEMEN SPEAR & SHIELD 2
9947020113107



MARAUDER HORSEMEN SPEAR & SHIELD 3
9947020113108



MARAUDER HORSEMEN SPEAR & SHIELD 4
9947020113109



MEDIEVAL HORSE SPRUE (RANDOM 1 BODY)
(SHOWN 60% ACTUAL SIZE)
99389999003



MARAUDER HORSEMEN AXE & SHIELD 2
9947020113111



MARAUDER HORSEMEN AXE & SHIELD 1
9947020113110



MARAUDER HORSEMEN AXE & SHIELD 3
9947020113112



MARAUDER HORSEMEN AXE & SHIELD 4
9947020113113



MEDIEVAL HORSE HEAD SPRUE (RANDOM 1 HEAD & TAIL)
(SHOWN 60% ACTUAL SIZE)
99389999013

All miniatures are supplied unpainted. Models, bits, and sprues are all shown actual size unless otherwise noted. Contents may vary slightly from those shown.



RARE UNITS



Hellcannon of Chaos Box (1)
99110201170

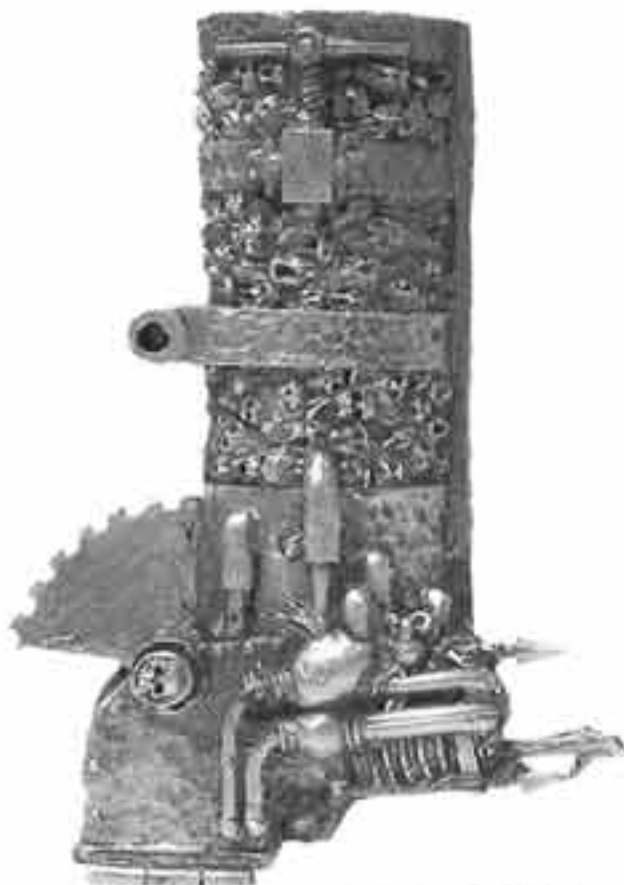

HELLCANNON BARREL LEFT SIDE
9947020117005



HELLCANNON BARREL RIGHT SIDE
9947020117006



**HELLCANNON
LARGE WHEEL 1**
9947020117009



**HELLCANNON
LARGE WHEEL 2**
9947020117010



**HELLCANNON CHAOS
STAR SYMBOL**
9947020117012



HELLCANNON BLAST SHIELD
9947020117013



HELLCANNON PLATES
9947020117018



**HELLCANNON CREW
ACCESSORY SPRUE**
9947020117004



HELLCANNON CHAINS
9947020117026



HELLCANNON CREWMAN 1
9947020117001



HELLCANNON CREWMAN 2
9947020117002



HELLCANNON CREWMAN 3
9947020117003



**HELLCANNON SKULL
BOTTOM JAW**
9947020117015



**HELLCANNON SKULL
TOP JAW**
9947020117014

RARE UNITS



HELLCANNON
SMALL WHEEL
9947020117011



HELLCANNON
COG 2
9947020117017



HELLCANNON
COG 1
9947020117016



HELLCANNON
PILE OF SKULLS 1
9947020117020



HELLCANNON
PILE OF SKULLS 2
9947020117021



HELLCANNON SPIKES
9947020117019



HELLCANNON
PILE OF SKULLS 3
9947020117022



HELLCANNON
PILE OF SKULLS 4
9947020117023



HELLCANNON FRAME
LEFT SIDE
9947020117007



HELLCANNON FRAME
RIGHT SIDE
9947020117008



HELLCANNON
PILE OF SKULLS 5
9947020117024



HELLCANNON
PILE OF SKULLS 6
9947020117025

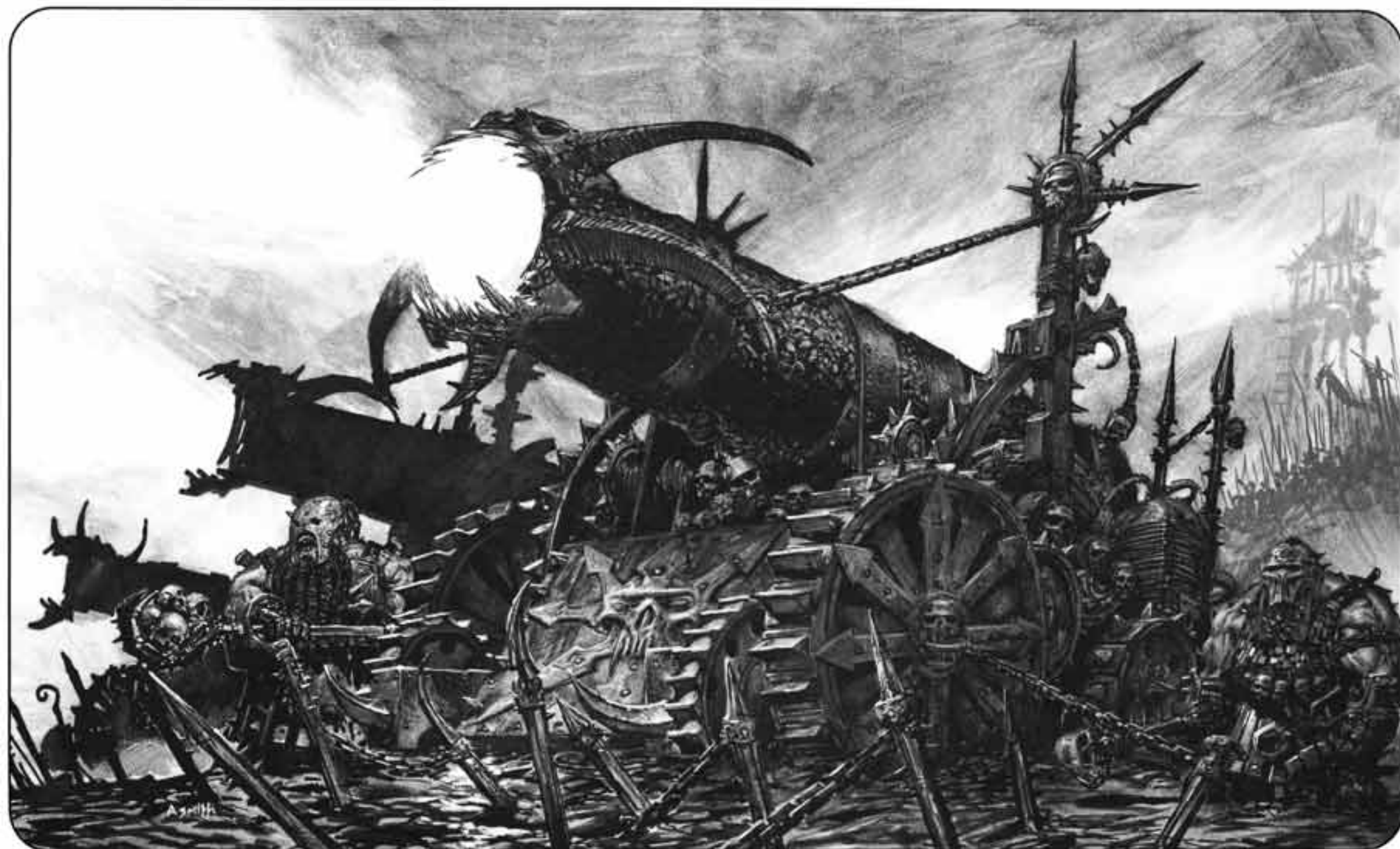

COLORS OF WAR



KEY

■ Top Box(es): Basecoat Colors & Ink Washes

■ Bottom Box(es): Highlights

■ Mixed Colors



Shadow Grey, Dwarf Bronze
Space Wolves Grey, Burnished Gold



Chainmail, Blue Ink
Chainmail, Mithril Silver



Boltgun Metal, Dwarf Flesh
Mithril Silver, Dwarf Flesh & Skull White



Chaos Black, Elf Flesh
Shadow Grey, Elf Flesh & Skull White



Chaos Black, Red Gore
Burnished Gold, Skull White



Snot Green, Bestial Brown
Goblin Green, Bleached Bone



Chaos Black, Tentacle Pink
Shadow Grey, Tentacle Pink & Skull White



Catachan Green, Bestial Brown
Goblin Green, Bubonic Brown & Bleached Bone



Chaos Black, Tentacle Pink
Shadow Grey, Skull White



Chaos Black, Red Gore
Shadow Grey, Blood Red



Chaos Black, Warlock Purple
Shadow Grey, Mithril Silver



Snot Green, Brazen Brass
Scorpion Green, Shining Gold



Dark Angels Green, Tin Bitz
Scorpion Green, Mithril Silver



Scab Red, Dwarf Bronze
Blood Red, Shining Gold



Chaos Black, Blood Red
Shadow Grey, Sunburst Yellow



Red Gore, Scorched Brown
Blood Red, Bleached Bone

TACTICS



TIPS FOR WINNING WITH HORDES OF CHAOS

- A. It's possible to create a Chaos army with a lot of points-heavy, powerful models like Archaon, Shaggoths, Chaos Giants, tricked-out Lords of Chaos, Lord-level Daemons, and the like. While these powerful models can be useful additions to your Hordes of Chaos army, too many of them can make for a weak force. Keep in mind that, often, the most effective elements of an army are fully ranked units with standards and high Unit Strengths. Make sure that a good percentage of your Chaos force is made up of such units. Use large, powerful models sparingly and only to support your big units, and you won't go far wrong.
- B. Consider fielding a 10-strong unit of Chosen Warriors of Khorne with additional hand weapons and full command. Some players might be tempted to field a larger unit, but at 305 points, the minimum unit size of 10 is already a serious investment. Plus, this unit's effectiveness comes from the number of Attacks it can dish out and not its Unit Strength or rank bonus. These Warriors will make 4 Attacks each – the Champion will make 5. Thus, with a frontage of six (any wider becomes cumbersome and loses the rank bonus), the unit will make 25 Attacks at WS5 and S4. Very few things can stand up to that for long.
- C. Horrors are interesting additions to a Chaos army, but they are vulnerable in combat and can lose a fair fight to a bunch of one-armed Goblins. Thus, it's important to protect your Horrors and keep them out of combat with everything except the weakest of foes. Even weak troops in sufficient numbers can threaten Horrors and should be avoided. Always take as many Flamers as you can to accompany your Horrors. When an enemy unit threatens to charge your Horrors, interpose your Flamers in a straight line in such a way that the enemy unit would have to charge and fight them one at a time. While the enemy chews up your Flamers, move your Horrors to safety and possibly into position to blast the enemy unit with spells.

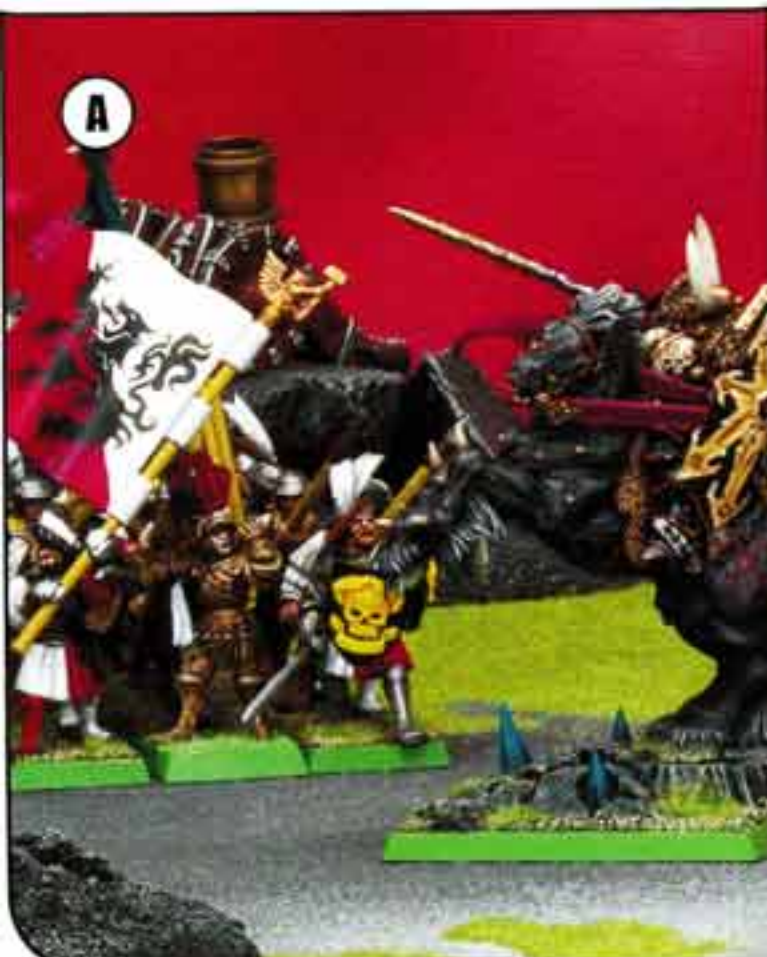

COUNTERTACTICS

TIPS FOR FIGHTING AGAINST HORDES OF CHAOS

- A. To fight large and powerful Chaos models, tempt your opponent into using his big models to engage your fully ranked units with command. Even the most powerful Monsters and characters will have difficulty defeating a full unit. Most often, units will begin such fights with a 5-point advantage toward combat resolution (i.e., 3 for ranks, 1 for the standard, and 1 for outnumbering). Even the most powerful models will have difficulty overcoming this advantage. Above all, avoid situations in which the big models can attack your units in concert with a fully ranked regiment or another big model. Also, protect against flank charges to preserve your rank bonus.
- B. Chosen Warriors of Khorne are always tough. However, *Frenzy* is a double-edged sword. *Frenzied* models must always charge targets that are in range. Thus, make sure to include a couple of low-point, highly maneuverable units to distract the Warriors. On your turn, move your distraction unit into the Warriors' charge range and, when the inevitable charge comes, flee. Try to set your distraction unit in such a way that the Warriors' failed charge will move them away from the rest of your army and/or into an inconvenient position. Repeat this maneuver as needed. *Fast Cavalry* units are ideal for distraction duty, but Skirmishers, other cheap cavalry models, Hounds of Chaos, cheap Flyers, and the like will also work well.
- C. The "Flamer chain" defense is a difficult one to counter. You can approach the Horror unit with two units of your own from two different directions. Thus, only one unit will be delayed, or both units will be delayed for only a short time. Another option is to ignore the Flamer chain and move to engage another unit. Yet another is to target the Horrors with missile fire and spells; with only T3, there are a lot of ranged attacks you can make that can devastate Horrors. Finally, highly maneuverable units like Flyers, *Fast Cavalry*, and Skirmishers can sometimes avoid the Flamer chain and charge the Horrors directly.

SHOWCASE

ALTERNATE MODEL – CORE Tzeentch Knights

COMPONENTS FOR 2 COMPLETE MODELS

- 99380299006 Bretonnian Horse Sprue (x2)
- 99380299007 Bret. Horse Head Sprue (x2)
- 9947010805104 Throne of Judgement Banners
- 9947020112604 Chaos Knight 4
- 9947020112609 Chaos Knight Shield 1 (x2)
- 9947020112618 Chaos Knight Champion
- 9947020114203 Tzeentch Lord Halberd (x2)

COMPLEXITY RATING



ALTERNATE MODEL – SPECIAL Flayerkin

COMPONENTS FOR 5 COMPLETE MODELS

- 9947010206706 Iron Warrior Head 2 (x4)
- 9947011001505 Flayed One Claws 1 (x3)
- 9947011001506 Flayed One Claws 2 (x2)
- 9947011202205 Jetbike Chains (x5)
- 9947020706701 Ghoul 1
- 9947020706704 Ghoul 4
- 9947020706706 Ghoul 6
- 9947020706709 Ghoul 9
- 9947020706711 Ghoul 11
- 9947021405002 Dark Emissary Head

COMPLEXITY RATING



ALTERNATE MODEL – CORE Nurgle Marauders

COMPONENTS FOR 4 COMPLETE MODELS

- 99360201002 Marauder Shield Sprue
- 99380201010 Chaos Marauder Sprue A
- 99380201011 Chaos Marauder Sprue B
- 99380207002 Zombie Sprue

COMPLEXITY RATING



SHOWCASE

Left: Vincent-Olivier Menard's Champion of Slaanesh won third place in the Warhammer Large Model category at the 2004 Canada Golden Demon painting competition.

Below: Matt Parkes's Chaos Lord of Slaanesh won first place in the Warhammer Monster at the 2003 UK Golden Demon painting competition.



Above: Jason Richards's Gorgoth the Ravager won first place at the 2004 Canada Golden Demon painting competition.

SHOWCASE

Far Left: A Chaos Warrior by Mike Anderson for the 2004 Storm of Chaos campaign.

Below: Doug Pirie's War Mammoth won first place in the Warhammer Large Model Category at the 2004 LA Golden Demon painting competition.



Above: Andrew Muir's Champion of the Northern Tribes won third place in the Youngbloods category at the 2004 Chicago Golden Demon painting competition.

Right: Michael Anderson's Chaos Lord on Dragon won third place in the Warhammer Monster at the 2003 UK Games Day Golden Demon painting competition.

SHOWCASE

Below: Jacob Nielsen's Chaos Knight Regiment won him the Slayer Sword at the 2003 UK Golden Demon painting competition.



Below: Jeff Freeman's Warband of Tzeentch won third place in the Open Category at the 2004 Atlanta Golden Demon painting competition.



LIZARDMEN

Sotek reigns as the great serpent-god of the Lizardmen, and every temple-city venerates His supreme divinity with a blood-soaked pyramid. Some believe that this foremost deity is one of the Old Ones returned, though most see Him as a wholly different entity from the creators of the Lizardmen. The growth of the Cult of Sotek started among the Skinks, who offered up thousands of rat-spawn in bloody sacrifices in His name, before spreading across all the Lizardmen lands. His coming was predicted in the Prophecy of Sotek. The bloody god's emergence into the world would be signaled by the appearance of a two-tailed comet in the heavens, representing his forked tongue. This appearance in the skies is received with rejoicing and blood sacrifices of thanks among the Lizardmen, for they know that it heralds the reawakening of Sotek, who will strike down their foes with His anger.

Long before the rise of Elves, Dwarfs, or Men, the Lizardmen walked the Warhammer world. Cold and enigmatic, Lizardmen seek to restore the order of the world that was brought before their mysterious creators disappeared ages ago. Although Lizardmen rarely venture out of their steaming jungle homes in Lustria and the Southlands, the cold-blooded ones do not discuss their plans and mercilessly punish any who would stand in their way.

Fighting Style

Lizardmen are an incredibly diverse army with an amazing number of strengths. Thus, there are loads of troop combinations and tactics to try out. One thing the Lizardmen benefit from is the *Cold-Blooded* rule, which means that they have a greater chance of passing Leadership tests (primarily Break and Psychology tests). Whether you are building a strong infantry-based army to roll over the field or you are going for more of a line up full of speed and power with troops like monsters, cavalry, and skirmishing Skinks, being *Cold-Blooded* will cause your enemy no ends of problems.

Collecting a Lizardmen Army

We always suggest beginning any new army with several Core choices. Not only will they cover the minimum requirements for a fairly

large game, but Core troops give players a strong nucleus from which to expand their forces. For Lizardmen, these Core choices often take the form of either Saurus Warriors or Skink Skirmishers. Both are suited for different roles, and both troop types excel at what they do. The Saurus Warriors are ferocious creatures that are strong, have multiple Attacks, and have a natural save with their Scaly Skin. All of these abilities make Saurus perfect infantry to secure the center of a battle line. Skinks are smaller and more agile, and their role in a Lizardmen army is that of skirmishers and light missile troops. Skinks are fast (Movement of 6), and their missiles count as *Poisoned Attacks*. Other Core choices include Jungle Swarms, which are ideal defensive troops that can tie up a flank, and Temple Guard, an elite unit of Saurus.

When filling out a Lizardmen army, players have even more fantastic choices. Kroxigors

are the larger cousins of the Saurus and are bred for power and brute strength (they have S5 and wield great weapons and thus attack at S7!). Terradons are enormous flying creatures that can carry Skink riders deep behind enemy lines. Chameleon Skinks are masters of camouflage and may use their ability to blend into a background to infiltrate just where they can do the enemy the most damage. Salamander Hunting Packs offer a wicked ranged attack. Saurus Cavalry on vicious Cold Ones constitute a very hard-hitting unit, and the mighty Stegadon is a lumbering dinosaur with Skinks on its back.

The sheer power of a Lizardmen army is topped off by its leaders: Slann Mage-Priests and Saurus Oldbloods. Slann Mage-Priests are among the oldest and most magically powerful beings in all existence, while the Saurus Oldbloods are ferocious fighters that may be mounted atop Carnosaurs, enormous flesh-eating dinosaurs.

Anyone who dares to fight the Lizardmen or invade their jungle territory does so at great peril.

Ben Bishop's "Stegadon on Parade" won the Slayer Sword at the 2004 Atlanta Games Day Golden Demon painting competition.

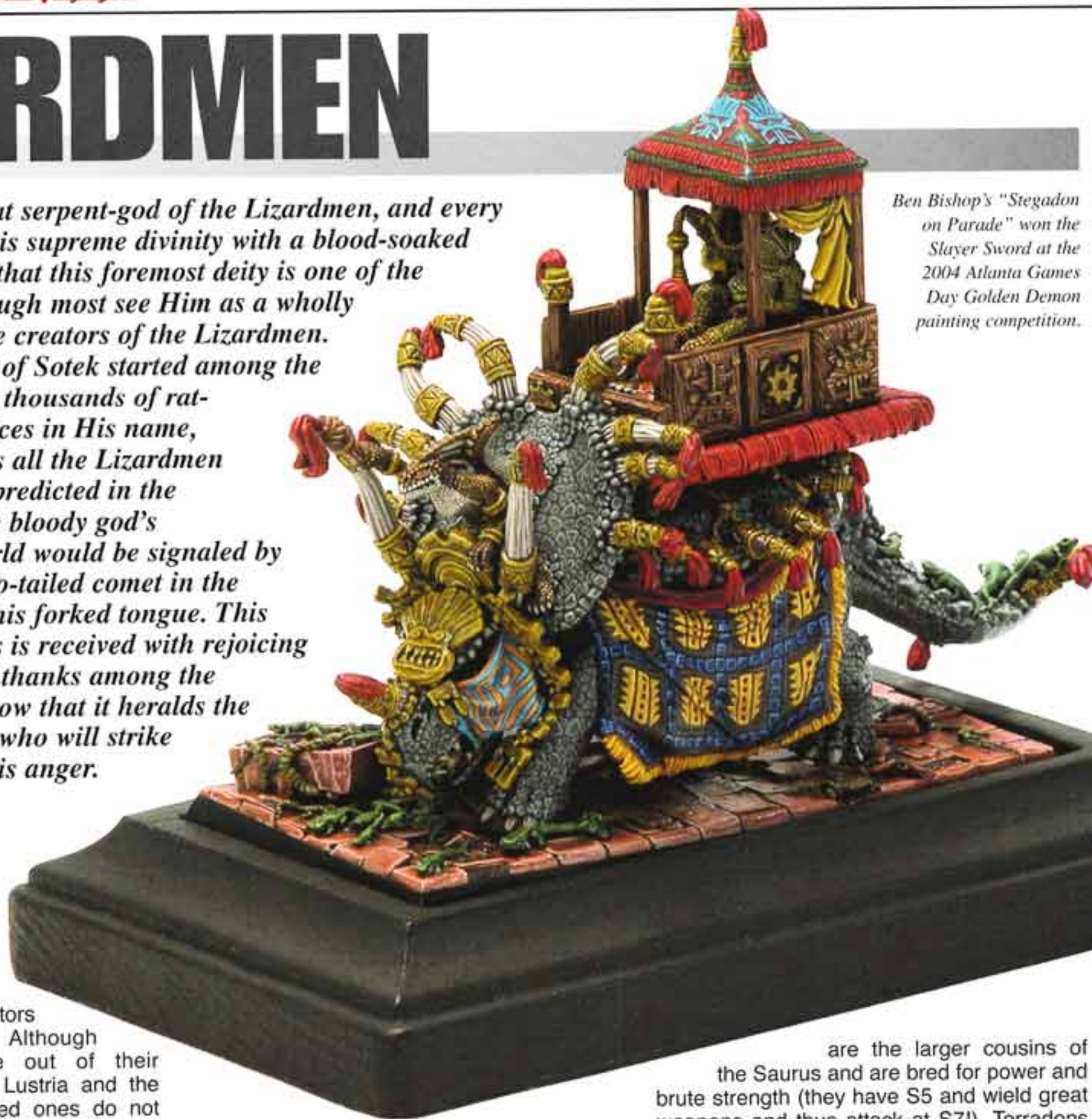



Lizardmen Battalion Box 99120208005

- 24 Saurus Warriors
- 24 Skink Skirmishers
- 8 Saurus mounted on Cold Ones



GETTING STARTED



This 80-page rulebook contains painting and modeling guides, background, and the full rules for the Lizardmen. Use this book to build your army and begin your conquest of the Old World.

**Warhammer Armies:
Lizardmen**
60030208001



SKINK WARCHIEF 3

SKINK WARCHIEF 4

SKINK WARCHIEF 1
9947020806501

SKINK WARCHIEF 2
9947020806502

**Skink Warchiefs
Blister (Random 2)**
99060208065



**Tehenhauin, Prophet of
Sotek Blister (1)**
99060208066



TEHENHAUIN BOOK
9947020806602



Skink Priest Blister (1)
99060208046

BIT NAME: SKINK PRIEST
BIT CODE: 9947020804601



SKINK WARCHIEF 3
9947020806503

SKINK WARCHIEF 4
9947020806504



TEHENHAUIN BASE
9947020806603



TEHENHAUIN BODY
9947020806601



LORDS & HEROES

LORDS & HEROES



Slann Mage-Priest Box (1)
99110208044



SLANN MAGE-PRIEST STANDARD
9947020804402



SLANN MAGE-PRIEST REAR PLATFORM
9947020804403



SLANN MAGE-PRIEST RIGHT SIDE
9947020804406



SLANN MAGE-PRIEST HORN SPRUE
9947020804408



SLANN MAGE-PRIEST STANDARD POLE
9947020804405

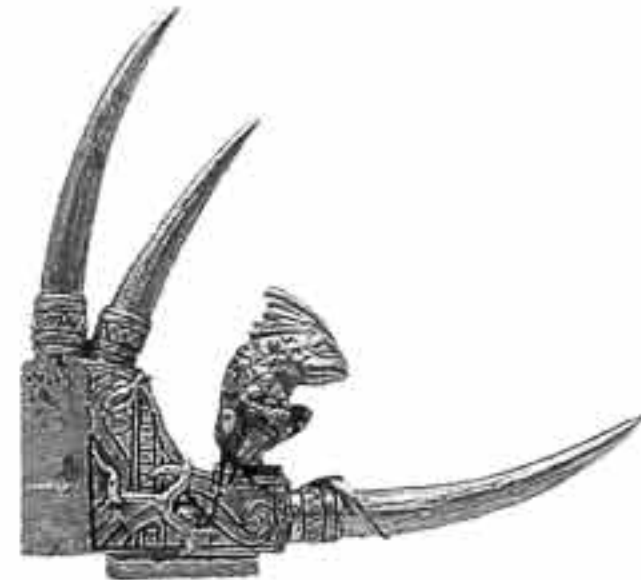

SLANN MAGE-PRIEST LEFT SIDE
9947020804407



SLANN MAGE-PRIEST PLATFORM BASE
9947020804404



SLANN MAGE-PRIEST BODY
9947020804401



Saurus Lord on Foot Blister (Random 1)
99060208058



SAURUS LORD ON FOOT BODY
9947020805803



SAURUS LORD ON FOOT SWORD ARM 1
9947020805806



SAURUS LORD ON FOOT SHIELD 1
9947020805804



SAURUS LORD ON FOOT SHIELD 2
9947020805805



SAURUS LORD ON FOOT HEAD 1
9947020805801



SAURUS LORD ON FOOT HEAD 2
9947020805802



SAURUS LORD ON FOOT SWORD ARM 2
9947020805807



LORDS & HEROES



Lord Kroak Box (1)
99110208055



LORD KROAK LEFT SIDE
9947020805508



LORD KROAK MASK
9947020805502



LORD KROAK RIGHT SIDE
9947020805506

The Lord Kroak boxed set includes the Slann Mage-Priest Standard Pole (9947020804405) shown with the Slann Mage-Priest.



LORD KROAK STANDARD
9947020805501



LORD KROAK BODY
9947020805504



LORD KROAK REAR PLATFORM
9947020805503



LORD KROAK PLATFORM BASE
9947020805507



LORD KROAK HORN SPRUE
9947020805505

LORDS & HEROES

LIZARDMEN SHIELDS

It can be much easier to paint the Saurus and shields separately. First, prime the shields with Chaos Black while they're still on the sprue.



STEP 1

Over the primer, drybrush the front of the shield with Scab Red and then Red Gore.



STEP 2

Paint the top half of each scale with Blood Red.



STEP 3

Add a highlight line around the top of each scale with Blazing Orange.



STEP 4

Paint the metal areas with Dwarf Bronze and the bony spikes with Bleached Bone.



STEP 5

Wash the metal and bone with Brown Ink. Highlight the bone with a 50/50 mix of Bleached Bone and Skull White and the metal areas with Shining Gold.



STEP 6

When the shields are finished, carefully clip them off the sprue, and touch up the bare spots before attaching them to the model.

Don't worry about the back of the shield too much, as it will not be seen when the regiment is assembled.



Almost all of your Saurus models, like this Saurus Lord on Foot, will carry shields.



Saurus Lord on Cold One Blister (Random 1)
99060208064



SAURUS LORD BODY
9947020806402



SAURUS LORD ARM
9947020806405



SAURUS LORD HEAD
9947020806401



SAURUS LORD BACK
9947020806403



SAURUS LORD SPRUE
9947020806404



LIZARDMEN COLD ONES SPRUE (RANDOM 1)
99380208004



LORDS & HEROES



Saurus Lord on Carnosaur Box (1)
99110208048



CARNOSAUR BODY
9947020804807



SAURUS LORD HEAD
9947020804802



CARNOSAUR TAIL
9947020804806



SAURUS LORD ARM SPRUE
9947020804801



SAURUS LORD SADDLE
9947020804805



CARNOSAUR LEFT CLAW
9947020804808



CARNOSAUR RIGHT CLAW
9947020804809



CARNOSAUR LEFT LEG
9947020804810



CARNOSAUR RIGHT LEG
9947020804811



SAURUS LORD BODY
9947020804803



SAURUS LORD SPEAR
9947020804804

All measurements are approximate. Models, bits, and pieces are all shown actual size unless otherwise noted. Contents may vary slightly from those shown.



CORE UNITS



PAINTING SAURUS



STEP 1

Undercoat the model with black primer and basecoat with Enchanted Blue. Next, drybrush with a 50/50 mix of Enchanted Blue and Ice Blue.



STEP 2

Give the entire model a wash of Blue Ink. Add a small drop of Gloss Varnish to the ink to allow it to coat more evenly.



STEP 3

Drybrush the skin of the Saurus with your 50/50 Enchanted Blue/Ice Blue mix to lighten the color again. Basecoat the armored scales on the back of the Saurus

with Regal Blue. Then, drybrush all of the scales with Enchanted Blue.



STEP 4

Add Ice Blue highlights to the skin of the Saurus. The skin is finished. All that needs to be completed are the details. Basecoat the spines along the back with Scab Red

and paint the teeth and claws with Bleached Bone. Basecoat the spear shaft with Scorched Brown.



STEP 5

Highlight the red markings with Red Gore and then with Blood Red. Also, place a spot of Blood Red in the eyes with a fine detail brush. Highlight the spear shaft with a 50/50 mix of Scorched Brown

and Snakebite Leather and then with straight Snakebite Leather.

STEP 6

Paint all the metal bits with Dwarf Bronze. Use Boltgun Metal for the blade of the spear. Wash the bronze parts, teeth, and claws with Brown Ink.

To finish, highlight the spear tip with Mithril Silver, the bronze areas with Shining Gold, and the teeth and claws with a 50/50 mix of Bleached Bone and Skull White.



Saurus Warriors Regiment Box (16)
99120208003

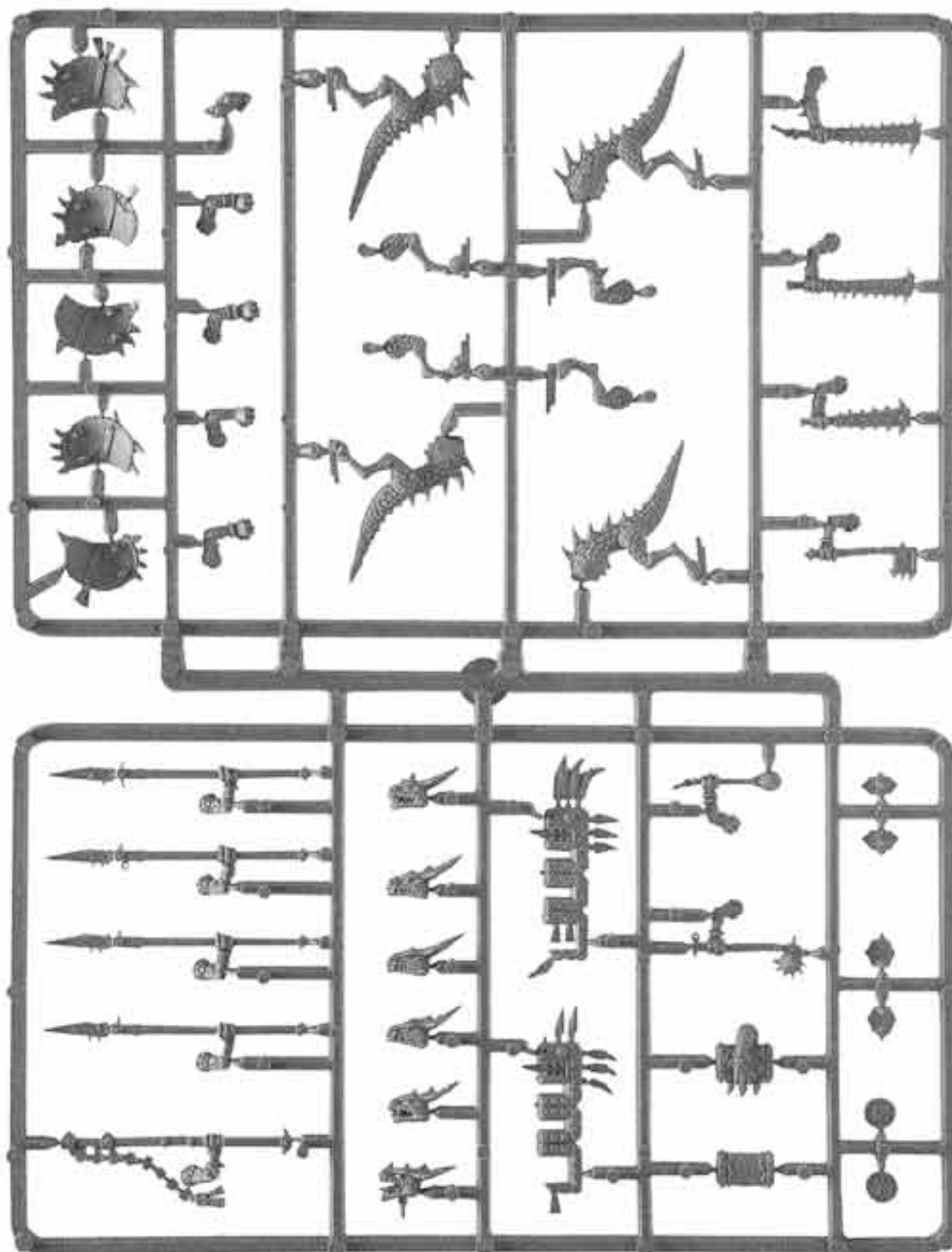

SAURUS WARRIORS SPRUE (SHOWN 50% ACTUAL SIZE)
99380208001

CORE UNITS

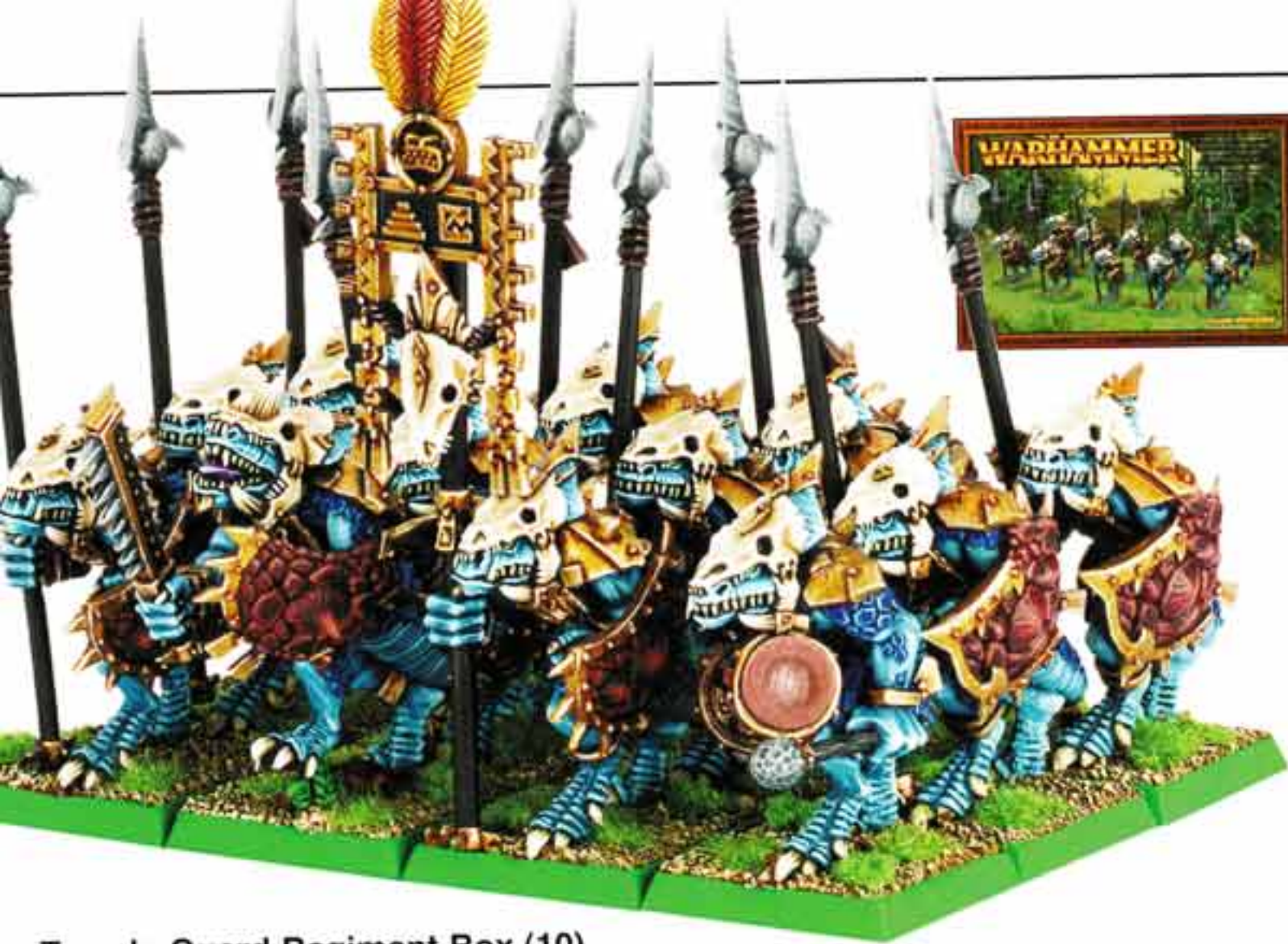

Temple Guard Regiment Box (10)

99110208051

Temple Guard Command Blister (2)

99060208060

Temple Guard Champion Blister (1)

99060208050



TEMPLE GUARD CHAMPION

9947020805002

The Temple Guard Command blister contains one complete Standard Bearer model and one complete Musician model.



TEMPLE GUARD STANDARD BEARER BODY
9947020806004



TEMPLE GUARD STANDARD TOP
9947020806003



TEMPLE GUARD MUSICIAN
9947020806001



TEMPLE GUARD SHIELD 1
9947020805109



TEMPLE GUARD SHIELD 2
9947020805110



TEMPLE GUARD HALBERD A
9947020805105



TEMPLE GUARD HALBERD B
9947020805106



TEMPLE GUARD HALBERD C
9947020805107



TEMPLE GUARD HALBERD D
9947020805108



TEMPLE GUARD STANDARD BEARER ARM
9947020806005



TEMPLE GUARD SWORD ARM
9947020805001



TEMPLE GUARD CHAMPION SHIELD
9947020805003



TEMPLE GUARD MUSICIAN ARM
9947020806002



TEMPLE GUARD BODY A
9947020805101



TEMPLE GUARD BODY B
9947020805102



TEMPLE GUARD BODY C
9947020805103



TEMPLE GUARD BODY D
9947020805104

CORE UNITS



Skink Warriors Regiment Box (24)
99120208004

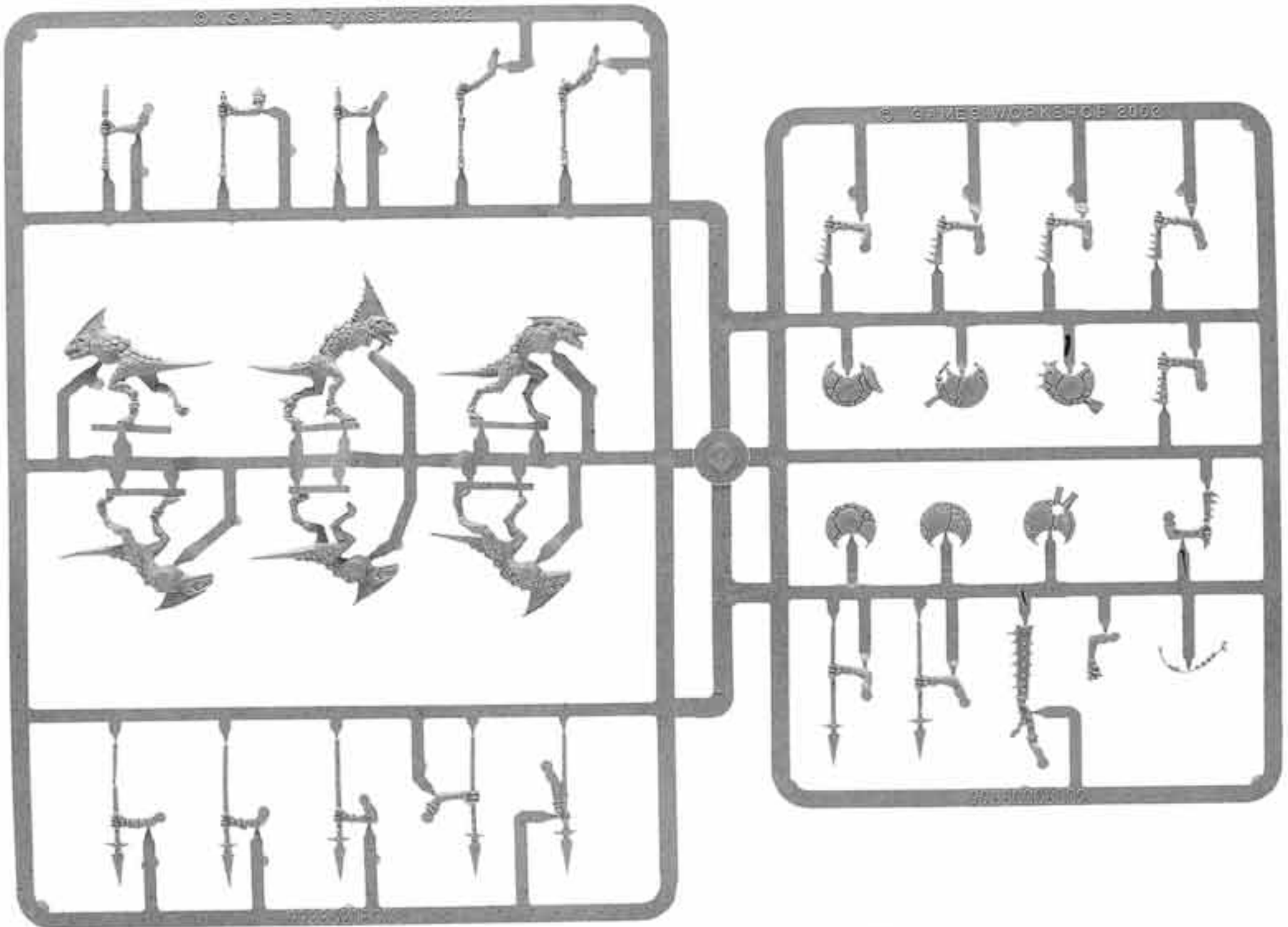

SKINK WARRIORS SPRUE (SHOWN 45% ACTUAL SIZE)
99380208002

CORE UNITS



Jungle Swarm Blister (2 Random Bases)
99060208063



JUNGLE SWARM SERPENT 1
9947020801901



JUNGLE SWARM SERPENT 2
9947020801902



JUNGLE SWARM SERPENT 3
9947020801903



JUNGLE SWARM SERPENT 4
9947020801904



JUNGLE SWARM SERPENT 5
9947020801905



JUNGLE SWARM SERPENT 6
9947020801906



JUNGLE SWARM SERPENT 7
9947020801907



JUNGLE SWARM SERPENT 8
9947020801908



JUNGLE SWARM LIZARD 1
9947020801301



JUNGLE SWARM LIZARD 2
9947020801302



JUNGLE SWARM LIZARD 3
9947020801303



JUNGLE SWARM LIZARD 4
9947020801304



JUNGLE SWARM LIZARD 5
9947020801305

SPECIAL UNITS



Kroxigor Blister (Random 1)
99060208045

Kroxigor weapon bits attach to the Kroxigor body with the corresponding number.



KROXIGOR WEAPON 1
9947020804502



KROXIGOR WEAPON 2
9947020804504



KROXIGOR BODY 1
9947020804501



KROXIGOR BODY 2
9947020804503

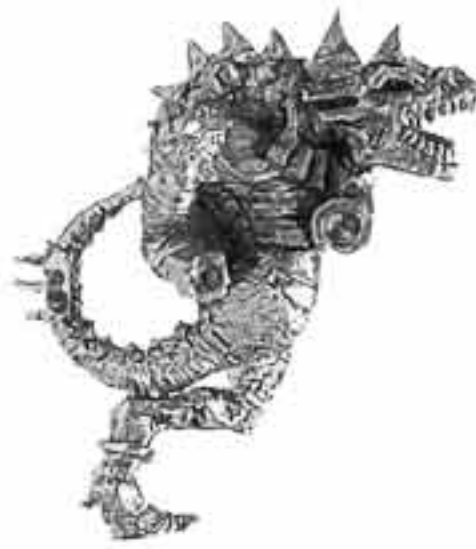

KROXIGOR BODY 3
9947020804505

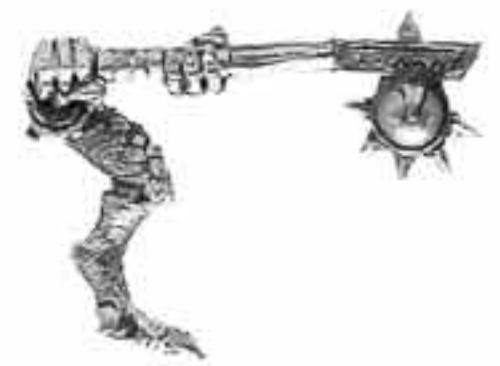

KROXIGOR WEAPON 3
9947020804506

SPECIAL UNITS

The Saurus on Cold Ones come with the Lizardmen Cold Ones Sprue (99380208004) shown with the Saurus Lord on Cold One.



Saurus on Cold Ones Box (8)
99120208006



CHAMELEON SKINK 1
9947020804701



CHAMELEON SKINK 2
9947020804702



CHAMELEON SKINK 3
9947020804703



CHAMELEON SKINK 4
9947020804704

Chameleon Skinks Blister (Random 3)
99060208047

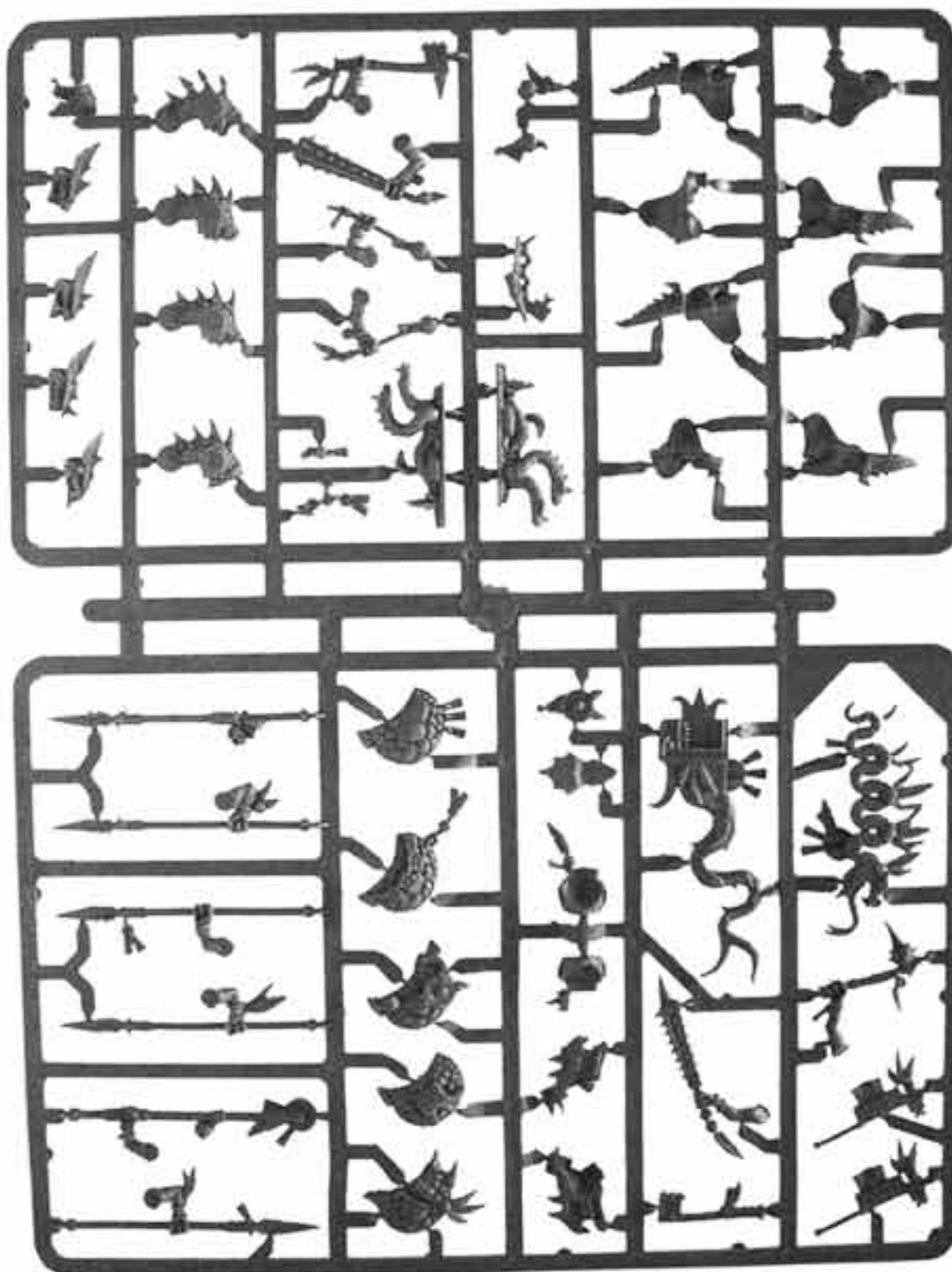

SAURUS COLD ONE RIDERS SPRUE (SHOWN 50% ACTUAL SIZE)
99380208003

SPECIAL UNITS



Terradon Blister (Random 1)
99060208057



TERRADON HEAD 1
9947020805701



TERRADON HEAD 2
9947020805702



TERRADON LEFT WING 2
9947020805706



TERRADON SKINK 1
9947020805708



TERRADON RIGHT WING 2
9947020805707



TERRADON LEFT WING 1
9947020805704

TERRADON RIGHT WING 1
9947020805705



TERRADON SKINK 2
9947020805709



TERRADON BODY
9947020805703

LIZARDMEN BEAST COLOR PATTERNS

STRIPES



STEP 1

Give the Terradon a basecoat of Vomit Brown. Highlight the raised areas with a 50/50 mix of Vomit Brown and Bubonic Brown. Paint the skin of the wings with streaks of Bubonic Brown.



STEP 2

Paint Snot Green stripes on the back behind the neck and leading edge. Extend the stripes toward the back of the Terradon.



STEP 3

Add highlights of Scorpion Green to the raised areas of the stripes.

SPOTS



STEP 1

Paint a basecoat of Red Gore onto the entire model, followed by a 50/50 highlight of Blood Red and Blazing Orange. Paint the skin of the wings with a 50/50 mix of Blood Red and Bleached Bone.



STEP 2

Paint a series of black spots starting at the shoulder and extending along the arm and back. The spots should become smaller the further they get from the shoulder.



STEP 3

Highlight the black spots with straight Shadow Grey.



RARE UNITS



STEGADON SKINK 1
9947020805402



STEGADON SKINK 2
9947020805403



STEGADON SKINK 3
9947020805404



STEGADON SKINK 4
9947020805405



Stegadon Box (1)
99110208054



STEGADON SKINK 5
9947020805406



STEGADON HOWDAH FRONT
9947020805401



STEGADON SKINK SHIELD SPRUE
9947020805407



STEGADON TOTEM
9947020801617



STEGADON BOW
9947020801613



STEGADON QUIVER 1
9947020801614



STEGADON QUIVER 2
9947020801615



STEGADON HORN
9947020801616



STEGADON HOWDAH SIDE 1
9947020805408



STEGADON HOWDAH SIDE 2
9947020805409



STEGADON HOWDAH BACK
9947020801611



STEGADON HOWDAH BASE
9947020805410

These Stegadon bits are included in the Stegadon boxed set shown on the opposite page.



RARE UNITS



STEGADON BODY RIGHT SIDE
994702020801601



STEGADON HORNY PLATE
9947020801603



STEGADON HEAD
9947020801605



STEGADON BODY LEFT SIDE
9947020801602

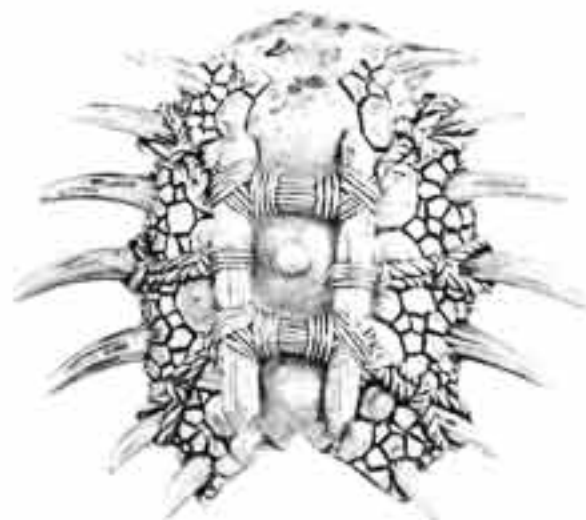

STEGADON BACK PLATE
9947020801604



STEGADON TAIL PLATE
9947020801606



STEGADON TAIL
9947020801607



Salamander Blister (Random 1 Salamander & 3 Skinks)
99060208052

SALAMANDER SKINK 1
9947020805205

SALAMANDER SKINK 2
9947020805206



SALAMANDER BODY
9947020805204



SALAMANDER LEG
9947020805203



SALAMANDER HEAD 1
9947020805201



SALAMANDER HEAD 2
9947020805202

COLORS OF WAR

KEY

■ Top Box(es): Basecoat Colors & Ink Washes

■ Bottom Box(es): Highlights

■ Mixed Colors



*Midnight Blue, Ultramarines Blue
Ice Blue*



*Enchanted Blue, Blue Ink
Enchanted Blue, Ice Blue*



*Regal Blue, Scaly Green
Enchanted Blue, Scaly Green & Skull White*



*Midnight Blue, Ultramarines Blue
Ultramarines Blue & Ice Blue*



*Hawk Turquoise, Fiery Orange
Ice Blue, Sunburst Yellow*

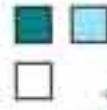

*Hawk Turquoise, Ice Blue
Skull White*



*Red Gore
Red Gore & Vomit Brown*

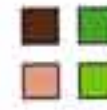

*Dark Flesh, Goblin Green
Dwarf Flesh, Scorpion Green*

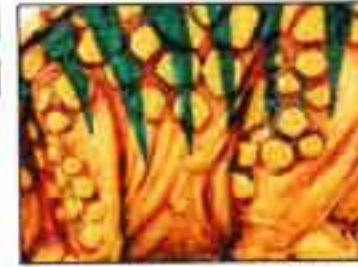

*Vermin Brown, Fiery Orange
Vomit Brown, Scaly Green*



*Hawk Turquoise, Enchanted Blue
Ice Blue, Blood Red*



*Hawk Turquoise, Snot Green
Ice Blue, Scorpion Green*



*Scab Red
Scab Red & Dwarf Flesh*



*Dark Angels Green, Camo Green
Goblin Green, Rotting Flesh*



*Shadow Grey, Red Gore
Fortress Grey, Blood Red*



*Hawk Turquoise, Liche Purple
Ice Blue, Liche Purple & Skull White*



*Hawk Turquoise, Regal Blue
Ice Blue, Blazing Orange*



*Dark Angels Green
Dark Angels Green & Bleached Bone*

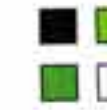

*Chaos Black, Scorpion Green
Goblin Green, Skull White*

TACTICS

TIPS FOR WINNING WITH LIZARDMEN



- A. A unit of Saurus with the Blessed Spawning of Sotek and led by a Scar-Leader or Scar-Veteran with the same Blessed Spawning can dish out an amazing number of Attacks on the charge. Add in a Battle Standard Bearer with a War Banner or the Jaguar Standard, and few opponents will survive the Saurus' devastating charge.
- B. A Saurus Scar-Leader or Scar-Veteran with the Charm of the Jaguar Warrior can move at high speeds. If such a Saurus were to follow a group of Kroxigor (who also move quickly), he could let the Kroxigor charge a unit in the front while moving to the side for a flank charge to support the Kroxigor – most likely hitting the target unit with a devastating number of high-strength Attacks. The Saurus Scar-Leader or Scar-Veteran could take a great weapon, the Blessed Spawning of Sotek, or the Scimitar of the Sun resplendent for even nastier charges.
- C. Jungle Swarms are a good way to protect your flank or offer a tempting target to your opponent's units (especially ones affected by *Frenzy*). While the Swarms hold off the enemy units, you can bring up hard-hitting units such as Saurus and Kroxigor to smash into the flanks of the enemy's formation. Because the Swarms have *Poisoned Attacks*, they may even manage to drag down some of your opponent's toughest models!
- D. A Second Generation Slann Mage-Priest with the Plaque of Tepok and the Plaque of Dominion has a very good chance of ruling supreme in the Magic Phase. For even more utility, invest in a Skink Priest with some Dispel Scrolls to provide some more defense against enemy spells and to give your Mage-Priest better line of sight for his own magic.



COUNTERTACTICS

TIPS FOR FIGHTING AGAINST LIZARDMEN

- A. There are many spells that can either slow a unit down or help pick off worryingly powerful characters like this one. In addition, you can aim your Cannons to draw a line through the Kroxigor and the Saurus hero, possibly turning both into bits of reptilian goo.
- B. A unit that is extremely powerful on the charge has most of its power tied up in the gamble that it WILL get to charge. Obviously, the best thing you can do with a unit like this one is to avoid getting charged by it! Often, this tactic means attacking first by hitting such a unit with your faster-moving models, but you can also slow this unit down with Flyers (inhibiting the march move) and by whittling it down to manageable size with enough missile fire (Bolt Throwers are very good for this purpose).
- C. One way to deal with pesky swarms is to shoot them. Jungle Swarms are skirmishers, however. Thus, another good method to handle these units are to send large regiments of cheap troops to hack the Swarms apart. Also, cavalry units can usually just outmaneuver the Swarms.
- D. A Slann Mage-Priest can cast spells like no other mage in the Warhammer world, but he is also hideously expensive points-wise. Thus, if you kill him, you'll earn a massive number of Victory Points. It may cost you dearly to focus your efforts on taking the Slann out of the game, but once he's dead, the Victory Points you gain (especially if the Slann is also the Battle Standard Bearer) will be well worth it! Also, keep in mind that Dispel Scrolls are only 25 points each and will shut down even a Slann's magic.

SHOWCASE

Right: Sam Darring's Carnosaur was a runner up at the 2004 Chicago Games Day Golden Demon painting competition.

Right: Aaron Wilson's Slann Mage-Priest won second place at the 2004 Chicago Games Day Golden Demon painting competition.



Below: A Saurus Champion painted by Werner Klocke.



ALTERNATE MODEL – HERO Skink Shaman

COMPONENTS

- 9947020401109 Warhawk C Body
- 9947020803302 Tenehuini Banner
- 9947020803303 Tenehuini Dagger
- 9947020803401 Oxayotl Body
- 9947020805001 Temple Guard Sword Arm

COMPLEXITY RATING



THIS CONVERSION CONTAINS THE SPECIAL OFFER BITZ SHOWN HERE
See the catalog introduction for more information.



ALTERNATE MODEL – LORD Saurus Oldblood

COMPONENTS

- 99380106005 Tyranid Warrior Sprue
- 99380208001 Saurus Warrior Sprue
- 9947020800904 Kroxigor Tail 2
- 9947020804408 Slann Horn Sprue
- 9947020804502 Kroxigor Weapon 1

COMPLEXITY RATING



THIS CONVERSION CONTAINS THE SPECIAL OFFER BITZ SHOWN HERE
See the catalog introduction for more information.



KROXIGOR TAIL 2
9947020800904

SHOWCASE



Far Left: Doug Bissett's Sacred Spawned Skink Priest won third place at the 2004 Atlanta Games Day Golden Demon painting competition.

Left: This Skink Shaman painted by Joe Hill earned a Gold in the 2001 U.K. Golden Demon competition.

Below: A Slann Mage-Priest diorama by Mark Tait.



Below: Zach Lanier's battle scene "Reclamation Loot" won third place at the 2004 Baltimore Games Day Golden Demon painting competition.



OGRE KINGDOMS

Small bands of Ogres have long wandered the lands of the Old World and sold their services as brutal mercenaries. We always thought that tales of entire tribes of these creatures were fanciful tales told by witless traders addled by their own exotic opiates. I have begun investigations, and these wild claims appear to be unfortunately true. As the local scouts are now reporting, dwindling caravans on the trade routes and the promise of plenty of meat further afield have encouraged some of these Ogre tribes to spread. Now the denizens of the Dwarfen realms are beginning to face skirmishing armies of these brutes. It will not be long before these marauders reach our border with their sights set on the fertile lands of Tilea and the southern Empire beyond.

I beg of you, cousin, to help strengthen the bulwark between these ravaging beasts and your realm by supplying me with three regiments of your Halberdiers at your earliest possible convenience.

– Excerpt from a letter by Prince Detlef Johanssen of the Border Princes to Emperor Karl Franz

Might makes right is the one overwhelming belief of the Ogres, beaten into them from birth. The biggest, strongest, heaviest Ogres rise to dominate their tribes, often over the fresh corpses of their rivals. No matter though, Ogres also live to eat, and they'll eat anything. Defeated rivals, Rhinox meat, boulders, rusty metal, and Gnoblar soup all form part of an Ogre's diet. Ogres are very proud of their enlarged bellies, covered in fat and layers of powerful muscle, which they

protect with distinctive gut-plates of ill-kept metal displaying the motif of the Great Maw – the Ogres' destructive god.

Fighting Style

Hard and fast are the two words that best describe the fighting style of the Ogre Kingdoms army. Facing an army full of Strength 4, Toughness 4, 3 Wound, *Fear*-causing monsters is a daunting prospect for any enemy. Add the fact that they can charge 12", and you have a brutal horde that is harder and faster than most.

The standard tactic employed by Ogre armies is "Chaaarge!" Most Ogre armies field small units of three or four Ogres, as a second rank is very costly (140+ points). Thus, the Ogres can't usually bring a lot of combat resolution to the fight, although their *Bull Charge* impact hits really help. To compensate for the lack of combat resolution, Ogre generals must maneuver flanking units into position for well-executed combination charges.

Gnoblar Fighters, while flimsy, bring their weight of numbers and really cheap rank bonuses (as little as 8 points per rank). Used in combination with their brutal masters, Gnoblars can boost the combat resolution for the Ogres and help break a unit in the 1st round of combat.

Yhetees, Gorgers, and Slavegiants can all be used to disrupt your enemy's battle line and distract him from the rapidly approaching Bulls and Ironguts. The more powerful



An Ogre from the Gutripper Tribe by Jason Craze

models will often unnerve your opponent and force him to redirect units or missiles that would have otherwise concentrated on your main battle line.

Finding the balance between Characters, Ogre units, and the more specialized choices is the greatest challenge for any Ogre Kingdoms general. If all else fails, just remember to "Chaaarge!"

Collecting an Ogre Kingdoms Army

At first glance, it may seem to be a really easy feat to build an Ogre Kingdoms army, and to a great extent, that's true. With a handful (well maybe 20 or so) Ogres, you can field a formidable army. It is important to begin with the compulsory unit of Ogre Bulls, a second smaller unit of Bulls, and a Hero of some description. The background of the Ogre Kingdoms will be a great guide in helping you develop a continuing theme for your army.

An Ogre tribe from high in the mountains might field more Hunters with full complements of Sabretusks geared to track down and drag back their prey, from cavebeasts to great mammoths.

An Ogre tribe from an area rich in herds of the ill-tempered Rhinoxen might field more Butchers, an obvious requirement for the carnivorous Ogres. You might also find more Gorgers, drawn by the scent of blood, in this type of army.

An Ogre tribe that trades with Chaos Dwarfs or regularly raids Empire caravans would field multiple units of Leadbelchers and perhaps a Gnoblar Scraplauncher. A handful of Maneaters would probably be present too.

Whichever way you decide to build your army never forget the most important thing. Might makes right!



For these latest additions to his Ironskin army, Dave Taylor chose to model the backs of his Ogres to look like the Great Maw.



Ogre Kingdoms Battalion Box 99120213005

- 6 Ogre Bulls
- 4 Ogre Leadbelchers
- 4 Ogre Ironguts
- 24 Gnoblar



GETTING STARTED

In addition to rules, you can find background on this new army and its land, a part of the Warhammer world that has been mentioned only in passing before. Even if you don't do a full Ogre army, this book can prove useful for any Warhammer general, as some Ogre units can be hired as Dogs of War!



**Warhammer Armies:
Ogre Kingdoms**
60030213001



The Hunter Box (3)
99110213003



LORDS & HEROES



HUNTER CLUB
9947021300302



HUNTER CROSSBOW
9947021300303



HUNTER BELLY GUARD 2
9947021300306



HUNTER SKULLS
9947021300307



HUNTER BELLY GUARD 1
9947021300305



HUNTER BODY
9947021300301



HUNTER SPEARS
9947021300304



HUNTER SABRETUSK BODY 1
9947021300308



HUNTER SABRETUSK BODY 2
9947021300310



HUNTER SABRETUSK SPRUE 1
9947021300309



HUNTER SABRETUSK SPRUE 2
9947021300311



LORDS & HEROES



The Ogre Tyrant boxed set contains enough bits to assemble one model. Multiple examples are shown here to illustrate some of the variations.



Ogre Tyrant Box (1)
99110213002



OGRE TYRANT GNOBLAR 1
9947021300215



OGRE TYRANT HEAD 1
9947021300201



OGRE TYRANT LEFT ARM 2
9947021300212



OGRE TYRANT BODY
9947021300204



OGRE TYRANT GNOBLAR 2
9947021300216



OGRE TYRANT HEAD 2
9947021300202



OGRE TYRANT RIGHT ARM 2
9947021300213



OGRE TYRANT GUT PLATE 1
9947021300205



OGRE TYRANT GUT PLATE 2
9947021300206



OGRE TYRANT GREAT WEAPON
9947021300214



OGRE TYRANT LEFT ARM 1
9947021300208



OGRE TYRANT RIGHT ARM 1
9947021300210



The Ogre Butcher boxed set contains enough bits to assemble one model. Multiple examples are shown here to illustrate possible variations.



Ogre Butcher Box (1)
99110213010



BUTCHER TORSO
9947021301002



BUTCHER LEGS
9947021301003

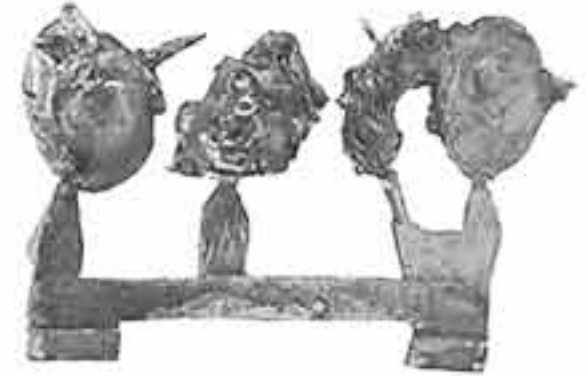

BUTCHER HEAD SPRUE
9947021301001



BUTCHER RIGHT ARM 1
9947021301004



BUTCHER RIGHT ARM 2
9947021301005



BUTCHER RIGHT ARM 3
9947021301006



BUTCHER GNOBLAR 1
9947021301007



BUTCHER GNOBLAR 2
9947021301008



BUTCHER ACCESSORY SPRUE
9947021301009



LORDS & HEROES



Greasus Goldtooth, Ogre King Box (1)
99110213004



**GREASUS GNOBLAR
RIGHT SIDE**
9947021300405



**GREASUS GNOBLAR
LEFT SIDE**
9947021300404



GREASUS HEAD/LEFT ARM SPRUE
9947021300401



GREASUS RIGHT ARM
9947021300403



GREASUS BODY
9947021300402



GREASUS GNOBLAR 1
9947021300407



GREASUS GNOBLAR 3
9947021300409



GREASUS GNOBLAR 2
9947021300408



GREASUS CHEST LID
9947021300406



LORDS & HEROES



Skrag the Slaughterer Box (1)
99110213005



SKRAG ARMS
9947021300502



SKRAG SPRUE
9947021300501



SKRAG CAULDRON LIQUID
9947021300508



SKRAG TORSO
9947021300503



SKRAG LEGS
9947021300505



SKRAG CAULDRON BODY
9947021300507



SKRAG GNOBLAR 1
9947021300510



SKRAG GNOBLAR 2
9947021300511



SKRAG GNOBLAR 3
9947021300512

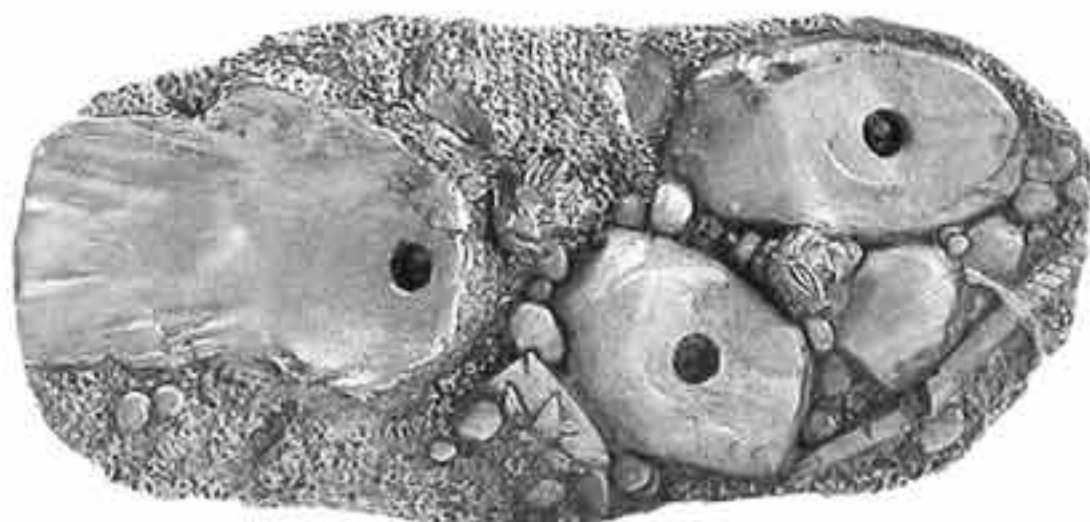

SKRAG BASE
9947021300513



SKRAG CAULDRON RIM
9947021300509



CORE UNITS



The Ogre Bulls also come with the Ogre Kingdom Command Sprue (99380213001) shown on the opposite page.



Ogre Bulls Box (6)
99120213001

MIXING OGRE FLESH PAINT

Mixing batches of paint before starting on an army will not only speed up your painting process but will keep the look of your army more consistent. Here is a fairly easy way to prepare your paints for your Ogres.



Take two empty paint pots and pour one part (a quarter of a pot) Shadow Grey into each one.

Fill the remaining three-quarters of the two mixing pots with Graveyard Earth.



Set one of the two basecoat pots aside. Take the other basecoat pot and pour half of the mix into an empty pot.



Mix one part Kommando Khaki into one of the pots. This pot is your second highlight color. Next,

mix one part Kommando Khaki and one part Bleached Bone into the second paint pot. This pot is your third highlight color.



For the final highlight color, pour the remaining Shadow Grey. Mix it thoroughly, then pour one part of the new Shadow Grey/Graveyard Earth mixture into the three-

quarters-full Bleached Bone pot to top it off. When the paint in the Bleached Bone pot is mixed thoroughly, you'll have your final skin highlight color.



PAINTING OGRE FLESH



Apply a slightly thinned basecoat over all of the Ogre flesh areas. Be sure to get in all the cracks.



Apply the second skin color. It will be a subtle highlight and may require a few coats. Cover all but the deepest recesses.



The third highlight color should start to define the raised areas more. Be sure to let some of the previous highlight show.



The final highlight should be reserved for the highest areas.

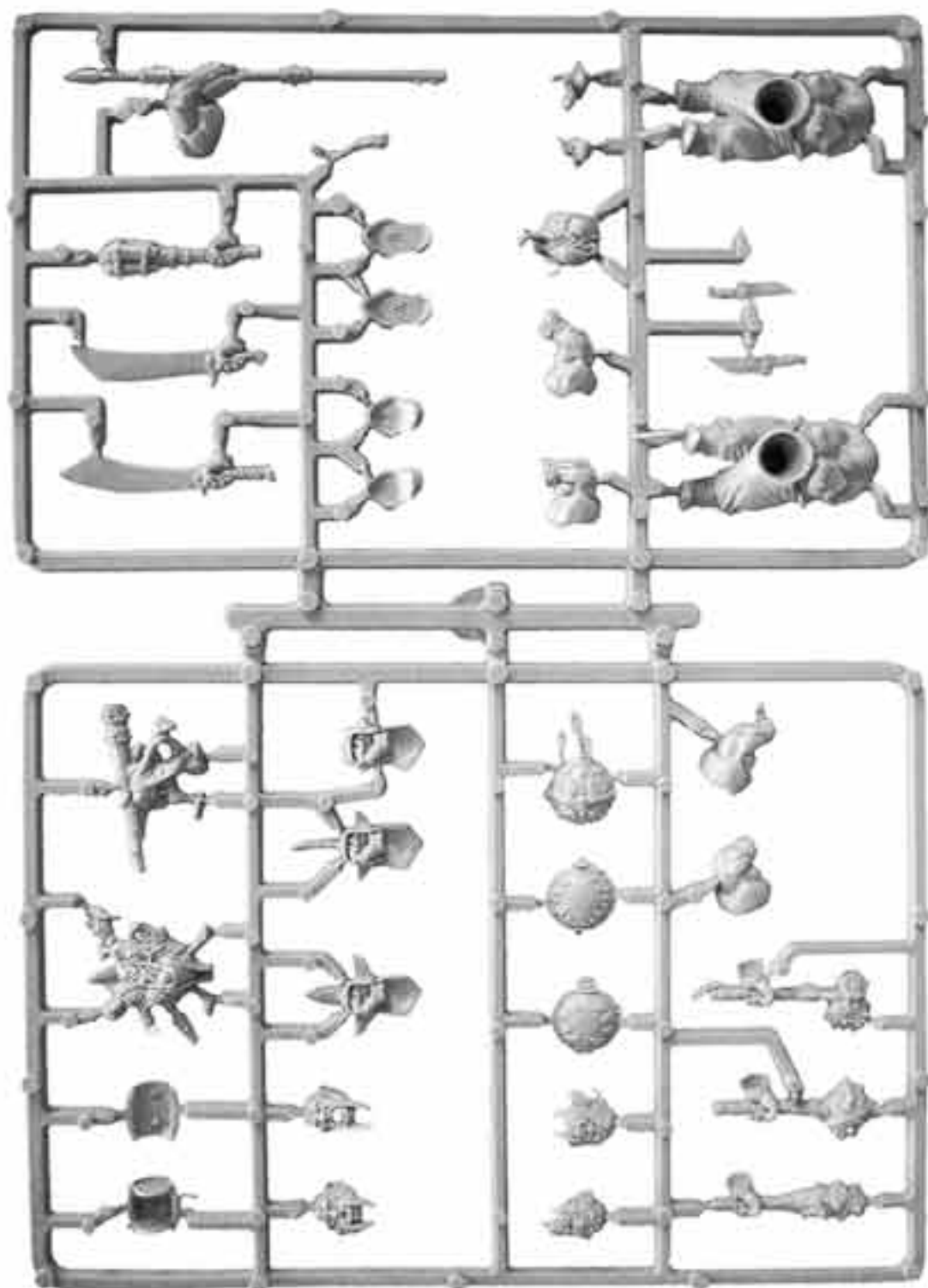

OGRE BULLS SPRUE (SHOWN 50% ACTUAL SIZE)
99380213005

CORE UNITS



The Ironguts also come with the Ogre Bulls Sprue (99380213005) shown on the opposite page.

Ironguts Box (4)
99120213004

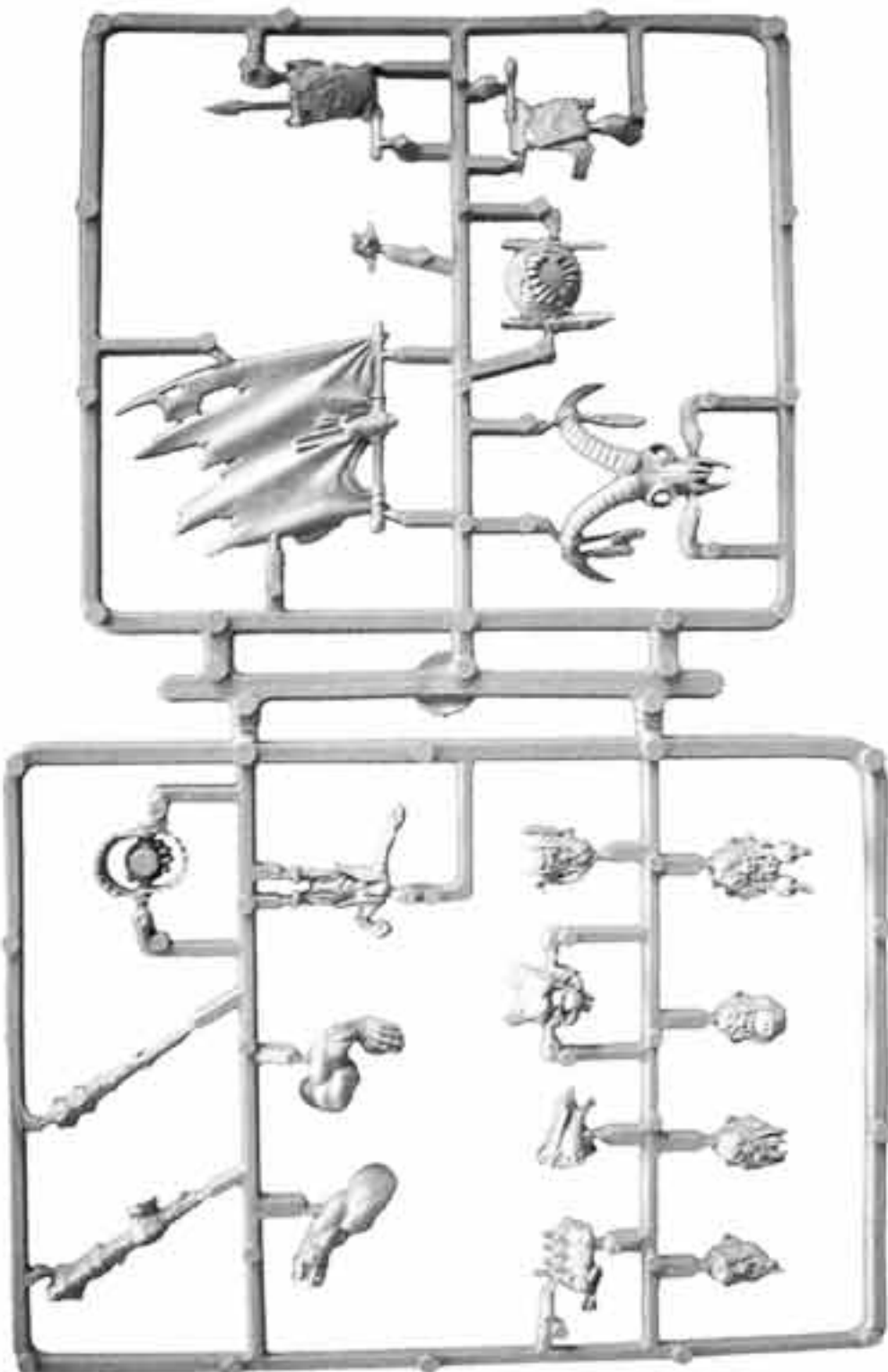

OGRE KINGDOM COMMAND SPRUE (SHOWN 50% ACTUAL SIZE)
99380213001

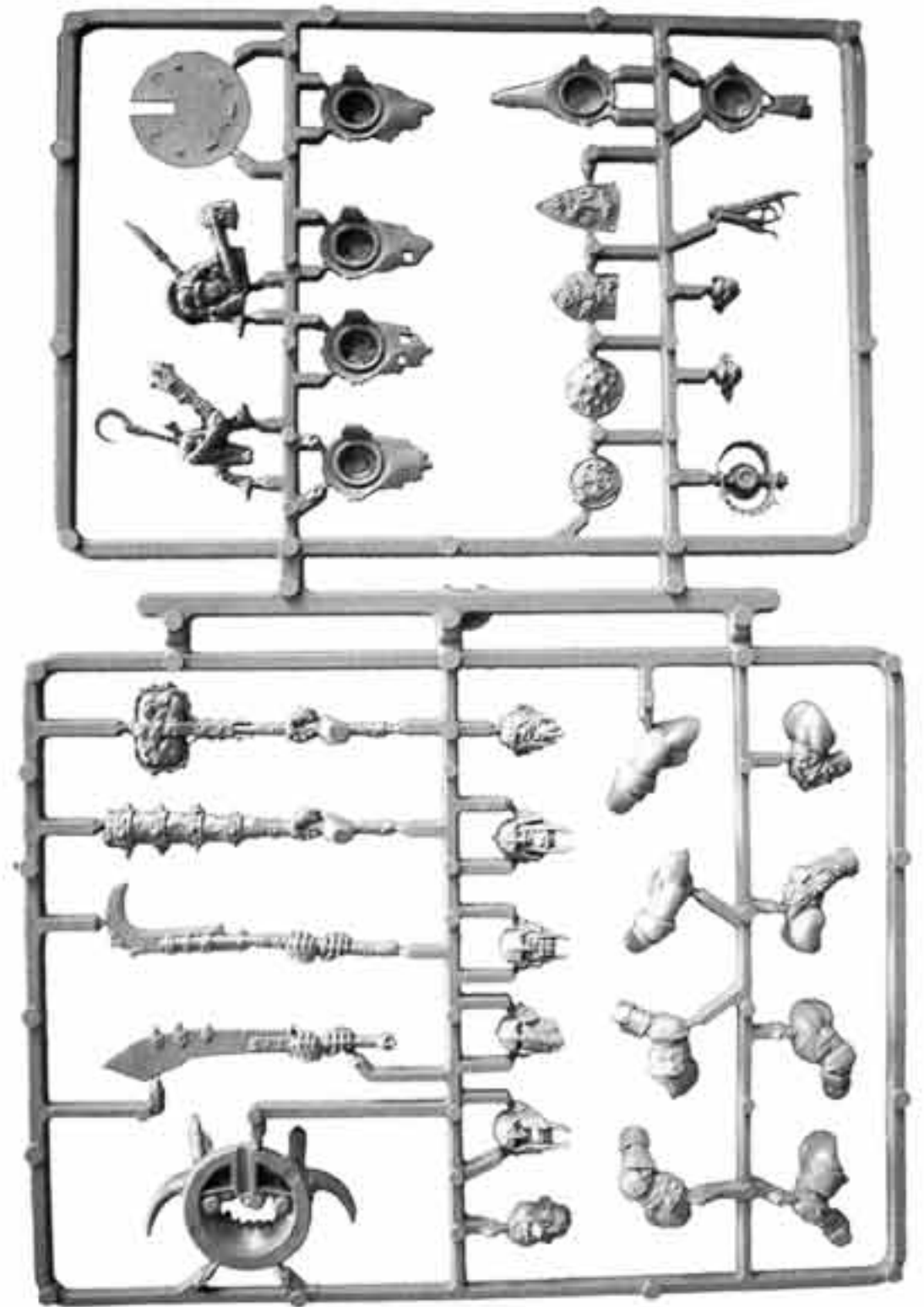

IRON GUTS SPRUE (SHOWN 50% ACTUAL SIZE)
99380213004



CORE UNITS



Gnoblar Box (24)
99120213002

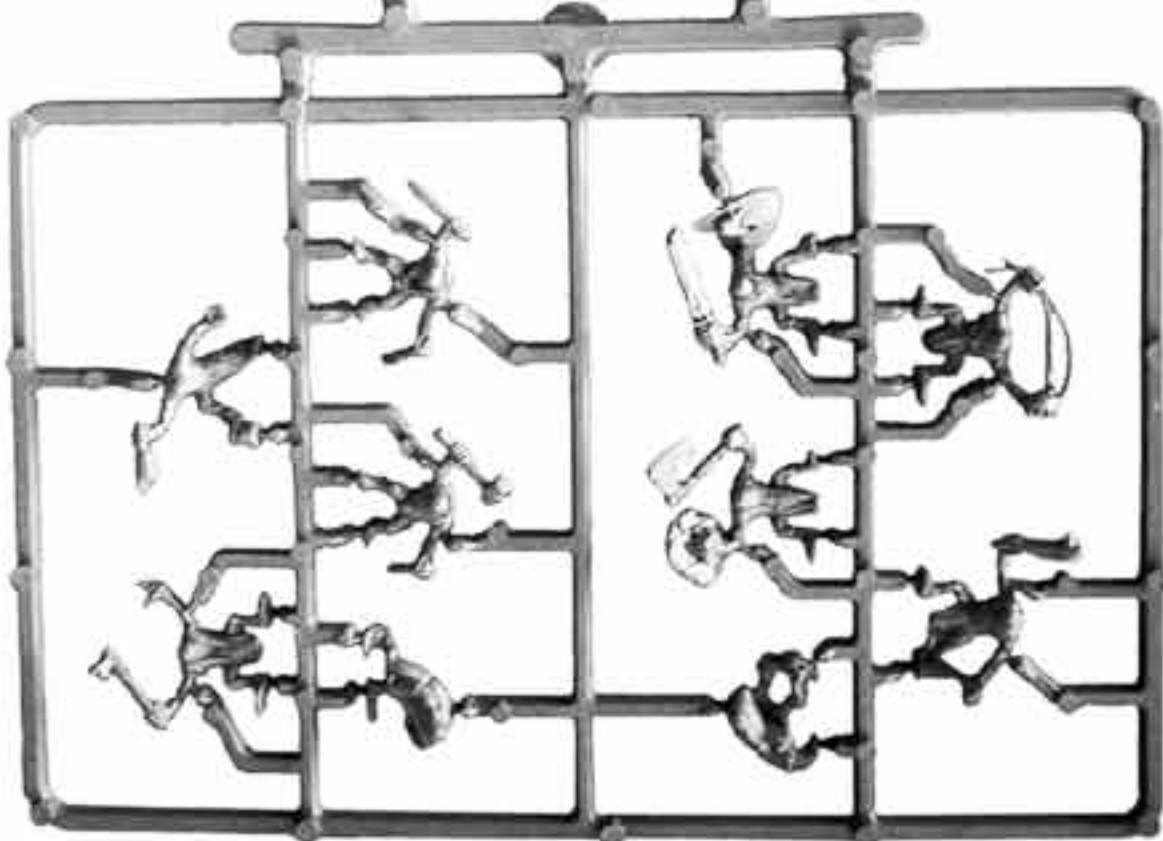
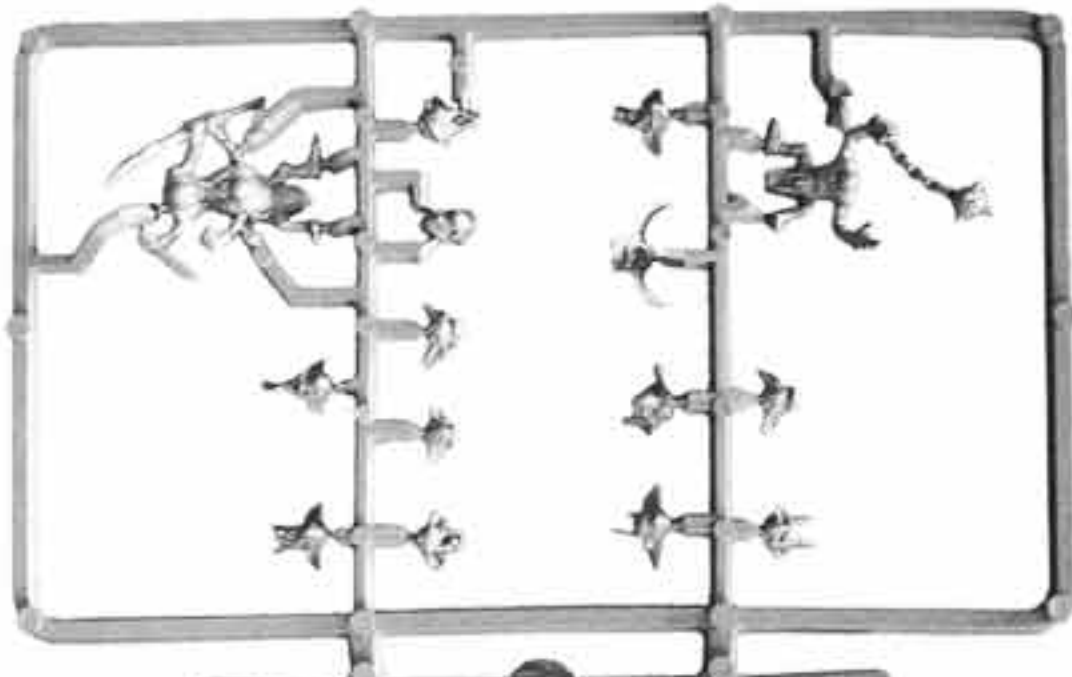

GNOBLAR SPRUE (SHOWN 50% ACTUAL SIZE)
99380213002

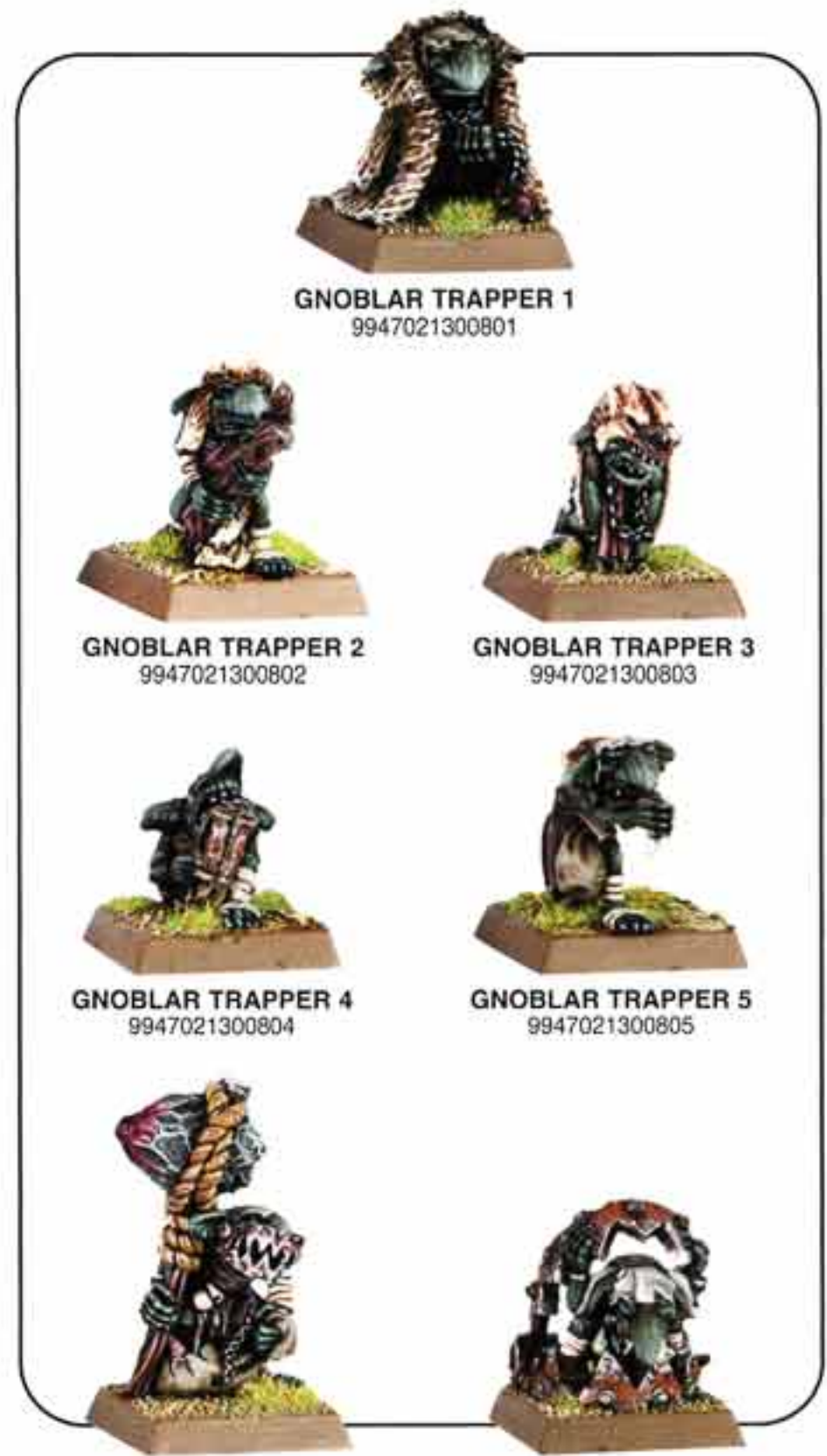

GNOBLAR TRAPPER 1
9947021300801



GNOBLAR TRAPPER 2
9947021300802



GNOBLAR TRAPPER 3
9947021300803



GNOBLAR TRAPPER 4
9947021300804



GNOBLAR TRAPPER 5
9947021300805



GNOBLAR TRAPPER 6



GNOBLAR TRAPPER 7

Gnoblar Trapper Blister (Random 4)
99060213008



GNOBLAR TRAPPER 6 HEAD
9947021300807



GNOBLAR TRAPPER 6 BODY
9947021300806



GNOBLAR TRAPPER 7
9947021300808



GNOBLAR TRAP UPPER JAW
9947021300809



GNOBLAR TRAP LOWER JAW
9947021300810

SPECIAL UNITS



Yhetees Blister (Random 1)
99060213011



YHETEE BODY 1
9947021301104



YHETEE BODY 2
9947021301105



YHETEE BODY 3
9947021301106



YHETEE HEAD 1
9947021301101



YHETEE HEAD 2
9947021301102



YHETEE HEAD 3
9947021301103



YHETEE LEFT HAND 1
9947021301110



YHETEE LEFT HAND 2
9947021301111



YHETEE LEFT HAND 3
9947021301112



YHETEE RIGHT HAND 1
9947021301107



YHETEE RIGHT HAND 2
9947021301108



YHETEE RIGHT HAND 3
9947021301109

All accessories are provided unpainted. Models, bits, and sprays are all shown at full size unless otherwise noted. Contents may vary slightly from those shown.



SPECIAL UNITS



Gnoblar Scraplauncher Box (1)
99110213006



SCRAPLAUNCHER RHINOX LEFT SIDE
9947021300620



SCRAPLAUNCHER RHINOX RIGHT SIDE
9947021300621



SCRAPLAUNCHER HAFT 2
9947021300607



SCRAPLAUNCHER HAFT 1
9947021300606



SCRAPLAUNCHER CREW 1
9947021300622



SCRAPLAUNCHER CREW 2
9947021300623



SCRAPLAUNCHER CREW 3
9947021300624



SCRAPLAUNCHER CREW 4
9947021300625



SCRAPLAUNCHER CREW 5
9947021300626



SCRAPLAUNCHER CREW 6
9947021300627



SCRAPLAUNCHER CREW 7
9947021300628



SCRAPLAUNCHER RHINOX HEAD
9947021300618

SPECIAL UNITS



SCRAPLAUNCHER SPRUE 1
9947021300610

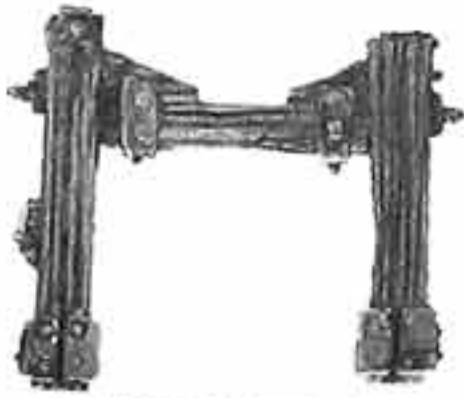

SCRAPLAUNCHER YOKE
9947021300605



SCRAPLAUNCHER BASE
9947021300604



SCRAPLAUNCHER SPRUE 2
9947021300611

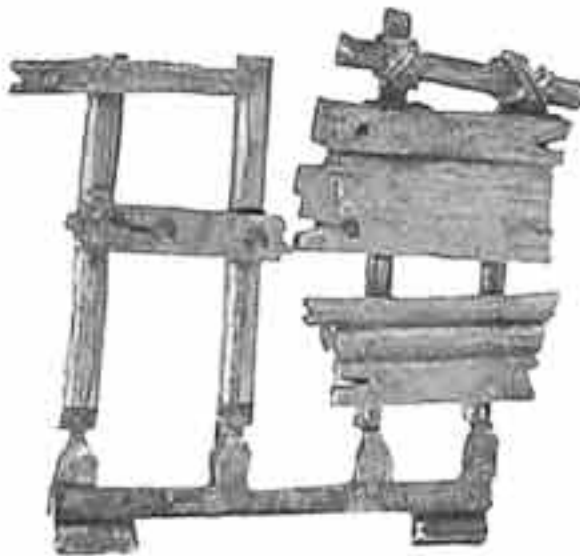

SCRAPLAUNCHER SPRUE 3
9947021300612



SCRAPLAUNCHER SPRUE 4
9947021300616



SCRAPLAUNCHER CATAPULT ARM
9947021300601



SCRAPLAUNCHER SPEAR
9947021300603



SCRAPLAUNCHER WINCH
9947021300602



SCRAPLAUNCHER CHAIN 1
9947021300608



SCRAPLAUNCHER CHAIN 2
9947021300609

PAINTING RUST EFFECTS STIPLING

This method is highly controlled. The approach to stippling is similar to drybrushing.

Step 1. Begin by painting a basecoat of Dark Flesh.

Step 2. Stipple Vermin Brown paint over the basecoat. Use an old, short-bristled brush – like a large drybrush – and wipe most of the paint off of it. Rather than drag the bristles across the surface of the model, as for drybrushing, dab the paint on to create random patterns.

Step 3. Complete the stippling effect with Blazing Orange. With successive highlights, build up some areas more than others to get a mottled effect.

Step 4. Once finished with the stippling, add tiny flecks of Chainmail to the edges of the model. This last step imitates the effect of rust being worn away to reveal the original metal beneath.



FLICKING WITH A PAINTBRUSH

This technique is simple. Just build up layers of paint by dipping an old toothbrush in paint and flicking it on. It's a lot of fun to do – messy, but fun. Warning: your work area will be covered in splashes of paint when you're through!



Step 1. Paint a basecoat of Dark Flesh onto the blade and let it dry.

Step 2. Flick a layer of Vermin Brown onto the blade.

Step 3. Flick some Blazing Orange onto the blade to finish it off.



SPECIAL UNITS



The Leadbelchers also come with the Ogre Bulls Sprue (99380213005) shown previously.



Leadbelchers Box (4)
99120213003

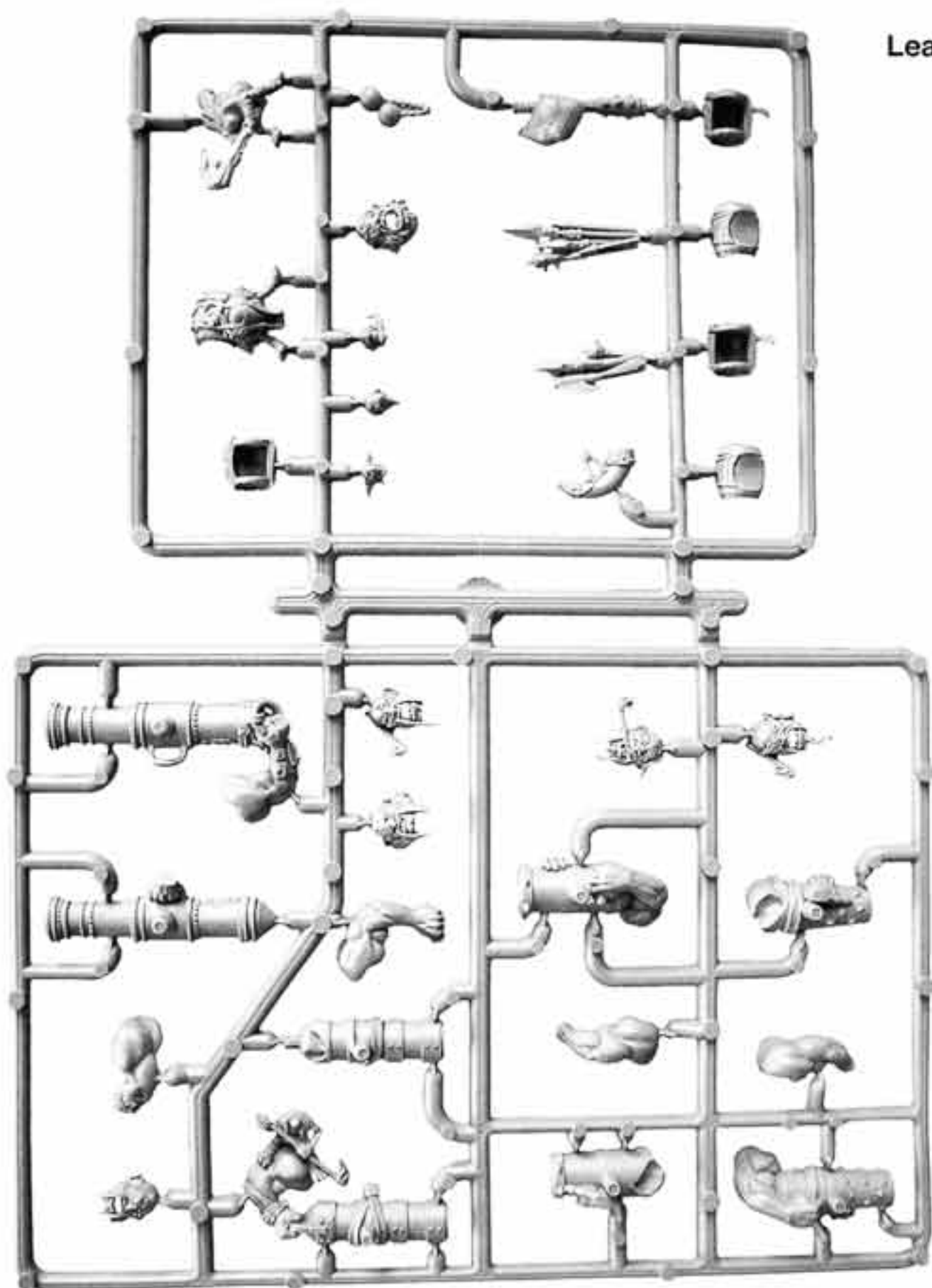

LEADBELCHER SPRUE (SHOWN 50% ACTUAL SIZE)
99380213003





The Ogre Female Maneater and Ogre Ninja Maneater Blisters are available only via Special Offer.



RARE UNITS



Ogre Female Maneater Blister (1)
99060213013



Ogre Ninja Maneater Blister (1)
99060213012



FEMALE MANEATER BODY
ONLY AVAILABLE IN BLISTER



NINJA MANEATER BODY
ONLY AVAILABLE IN BLISTER



NINJA MANEATER BACKPACK
ONLY AVAILABLE IN BLISTER



FEMALE MANEATER HEAD
ONLY AVAILABLE IN BLISTER



NINJA MANEATER SWORDS
ONLY AVAILABLE IN BLISTER



NINJA MANEATER HEAD
ONLY AVAILABLE IN BLISTER



FEMALE MANEATER BEARD
ONLY AVAILABLE IN BLISTER



NINJA MANEATER GNOBLAR
ONLY AVAILABLE IN BLISTER



FEMALE MANEATER ROLLING PIN
ONLY AVAILABLE IN BLISTER



NINJA MANEATER SWORD HAND
ONLY AVAILABLE IN BLISTER



RARE UNITS



Ogre Maneater Blister (Random 1)
99060213007



PIRATE MANEATER HEAD
9947021300711



PIRATE MANEATER GUTPLATE
9947021300713



PIRATE MANEATER ARMS
9947021300714



**PAYMASTER MANEATER
RIGHT ARM**
9947021300709



**PAYMASTER MANEATER
GUTPLATE**
9947021300708



**PAYMASTER MANEATER
SPRUE**
9947021300706



PIRATE MANEATER BODY
9947021300712



PAYMASTER MANEATER BODY
9947021300707



RARE UNITS



IMPERIAL MANEATER HEAD
9947021300716



IMPERIAL MANEATER HAMMER
9947021300718



ARABY MANEATER HEAD
9947021300701

"Maneaters. Been around those lads have. They been there and killed that. Now they're back to tell you about it."



IMPERIAL MANEATER BODY
9947021300717



ARABY MANEATER BODY
9947021300702



ARABY MANEATER GNOBLAR
9947021300705



ARABY MANEATER ARMS
9947021300703



Ogre Gorger Blister (Random 1)
99060213009



GORGER HEAD 1
9947021300901



GORGER HEAD 2
9947021300902



GORGER BODY
9947021300903



GORGER LEGS
9947021300906



GORGER RIGHT ARM
9947021300904



GORGER LEFT ARM
9947021300905



COLOURS OF WAR

KEY

■ Top Box(es): Basecoat Colors & Ink Washes

■ Bottom Box(es): Highlights

■ Mixed Colors

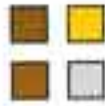

GOLDTOOTH TRIBE
Brazen Brass, Golden Yellow
Dwarf Bronze, Mithril Silver



MIGHTY FIST TRIBE
Ultramarines Blue, Chaos Black
Ice Blue, Red Gore

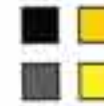

MOONBITER TRIBE
Chaos Black, Golden Yellow
Codex Grey, Bad Moon Yellow

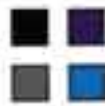

DEATHMAW TRIBE
Chaos Black, Regal Blue
Codex Grey, Enchanted Blue

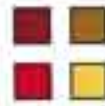

BLOODED GUT TRIBE
Red Gore, Dwarf Bronze
Blood Red, Burnished Gold

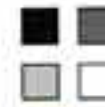

SKULLTAKER TRIBE
Chaos Black, Codex Grey
Fortress Grey, Skull White



SONS OF THE MOUNTAIN TRIBE
Shadow Grey, Brazen Brass
Skull White, Chainmail

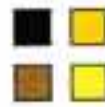

SUNEATER TRIBE
Chaos Black, Golden Yellow
Dwarf Bronze, Bad Moon Yellow

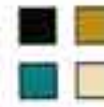

ROCKSPLITTER TRIBE
Chaos Black, Bubonic Brown
Hawk Turquoise, Bleached Bone

TACTICS



TIPS FOR WINNING WITH OGRES

A. Having ranks with your Ogre units is more important than just having one more point for Combat Resolution. Additional ranks give you +1 Strength when you Bull Charge with an Ogre unit. Having another full rank also helps when it comes to either outnumbering the opponent or being outnumbered. Since Ogres cause *Fear*, any opponent that loses a combat to them will automatically flee if the Ogres outnumber them. With the small unit sizes of Ogres, a unit of three or four will have to take a *Panic* test if it takes just one casualty. Having your Bulls and especially your more expensive Ironguts run away from the enemy after taking a single casualty can be crippling to your entire plan.

B. Ogres are among the fastest non-cavalry units in the game. Aside from the usual benefits of charging, as long as the unit charged over 6", the Ogres will cause impact hits. Since these hits are "free," you should endeavor to get them as often as possible.

C. Hunters with Sabretusks are great for protecting your flanks and mopping up units upon which the efforts of your other Ogres might be wasted. If a Hunter is able to reach lone enemy characters or war machine crews, he will usually be able to tear them to pieces. If need be, the Hunter can sic the Sabretusks on one unit and shoot his Harpoon Launcher at yet another unit, which is sure to draw your opponent's attention away from the rest of your Ogres.

D. Even though Ogres are the main thrust of the army, don't forget about the Gnoblar. They fill an important gap in the Ogre army as cheap units that can help win combats. Ogres will always lose out to infantry when it comes to outnumbering. Note that an Ogre unit in two ranks of four occupies the same amount of space as 32 Empire Spearmen. The Ogres will probably do more damage than the Spearmen. However, the Ogres are at a disadvantage with only one rank and a Unit Strength of 24 (the Spearmen have at least +3 Combat Resolution and a Unit Strength of 32). Gnoblar are cheap. Thus, if a player traded one Ogre for about 20 Gnoblar, against the same Spearmen, the Ogre player can get the +3 bonus from the Gnoblar ranks and a total Unit Strength of 41.



COUNTERTACTICS

TIPS FOR FIGHTING AGAINST OGRES

- A. A unit of Ogres in ranks is a huge target, both in terms of shooting targets and close combat. War machine fire will surely cause plenty of damage to such a unit. A unit that large will also be rather unwieldy. Thus, creative use of terrain and units of *Scouts*, *Flyers*, or *Fast Cavalry* can be used to slow the Ogre unit to a crawl and set them up for a flank charge by a unit of *Knights* or a concerted charge by two or three units. If nothing else, with that many points in one unit, your opponent can't possibly have that many more troops on the table (unless all are Gnoblar). As such, eliminating the unit will garner a heap of Victory Points.
- B. Since Ogres are so fast, you may be able to take advantage of their speed in various ways to get the charge on them rather than being charged. In scenarios where you are given the choice, electing to take the 2nd turn could prove advantageous. The Ogres will move first, allowing you to charge them as they move closer. For shooting armies, deploying slightly back from the front line of the Deployment Zone could throw off Ogre players who are used to charging in the 2nd turn. Deploying as such will give your models more time to shoot the oncoming hordes of Ogres.
- C. Since Hunters cannot join units, they can be sent packing with a decent amount of shooting or a unit's rank bonuses and standard in close combat. Crossbows, handguns, great weapons, and other such weapons will make short work of a Hunter and Sabretusks.
- D. Gnoblar are cheap and have the stat line to prove it. While the minimum unit size of a Gnoblar unit is 20, at Toughness 3 and Leadership 5, any sort of Leadership-based test will send them heading for the hills. Units such as *Screaming Skull Catapults*, *Banshees*, *Warpfire Throwers*, and *Flame Cannons* are great for getting rid of any lingering Gnoblar units you might come across.

SHOWCASE



Below: John Matthews used a jaundiced, yellowish hue for the skin on his Ogre unit, and the red tones of the war paint and standard contrast nicely.

Far Left: Ed Sires created this Khornate Ogre for his Chaos army.

Left: Eric Sarlin's Minotaur conversion was inspired by the movie Time Bandits.

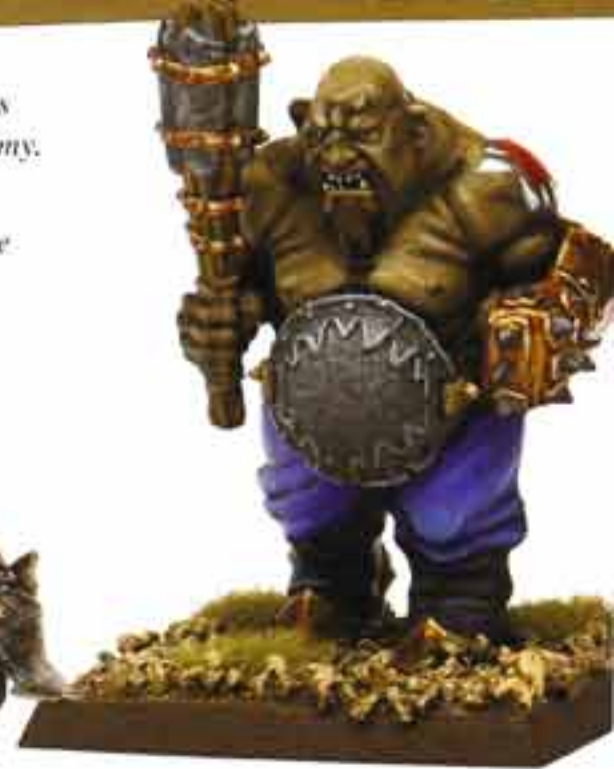

Above: An Ogre from the Mountain Eaters Tribe by Nicole Shewchuk.

Left: A two-headed Ogre by Mark Koscielniak.



Left: An Ogre from the Blooded Gut Tribe by Sean Forbes.

Lower Left: William Stilwell's Ogre is converted to have two swords.

Below: Mark Gregory's Deathmaw Tribe Ogre with a quartering effect.

Below: Japanese folklore inspired Stuart Spengler to create this Ogre patterned after the Oni, daemonic creatures who hunt for the souls of those who commit evil deeds.



Above: Aaron Dill's conversion would fit in well with a Chaos army made up of Beastmen or Norse Marauders.



SHOWCASE



Above: Stu Spengler modeled these Gnoblars as though they just returned from ravaging Bretonnian lands.

Below: Brad Deicas's Silverback Ogres paint their flesh to emulate the unique patterning of senior gorillas.



Above: These clever "Pigback Rider" Gnoblars by John Shaffer prove that two fighters are better than one.



ALTERNATE MODEL – RARE
Chaos Maneaters

COMPONENTS FOR 2 COMPLETE MODELS

- 99360201002 Marauder Shield Sprue
- 99380201010 Chaos Marauder Sprue A
- 99380201011 Chaos Marauder Sprue B
- 99380213005 Ogre Bull Sprue

COMPLEXITY RATING



Right: This Ogre standard bearer of the Moonbiter Tribe by John Sites carries an ornate standard stitched together from the banners of defeated enemies.

ORCS & GOBLINS

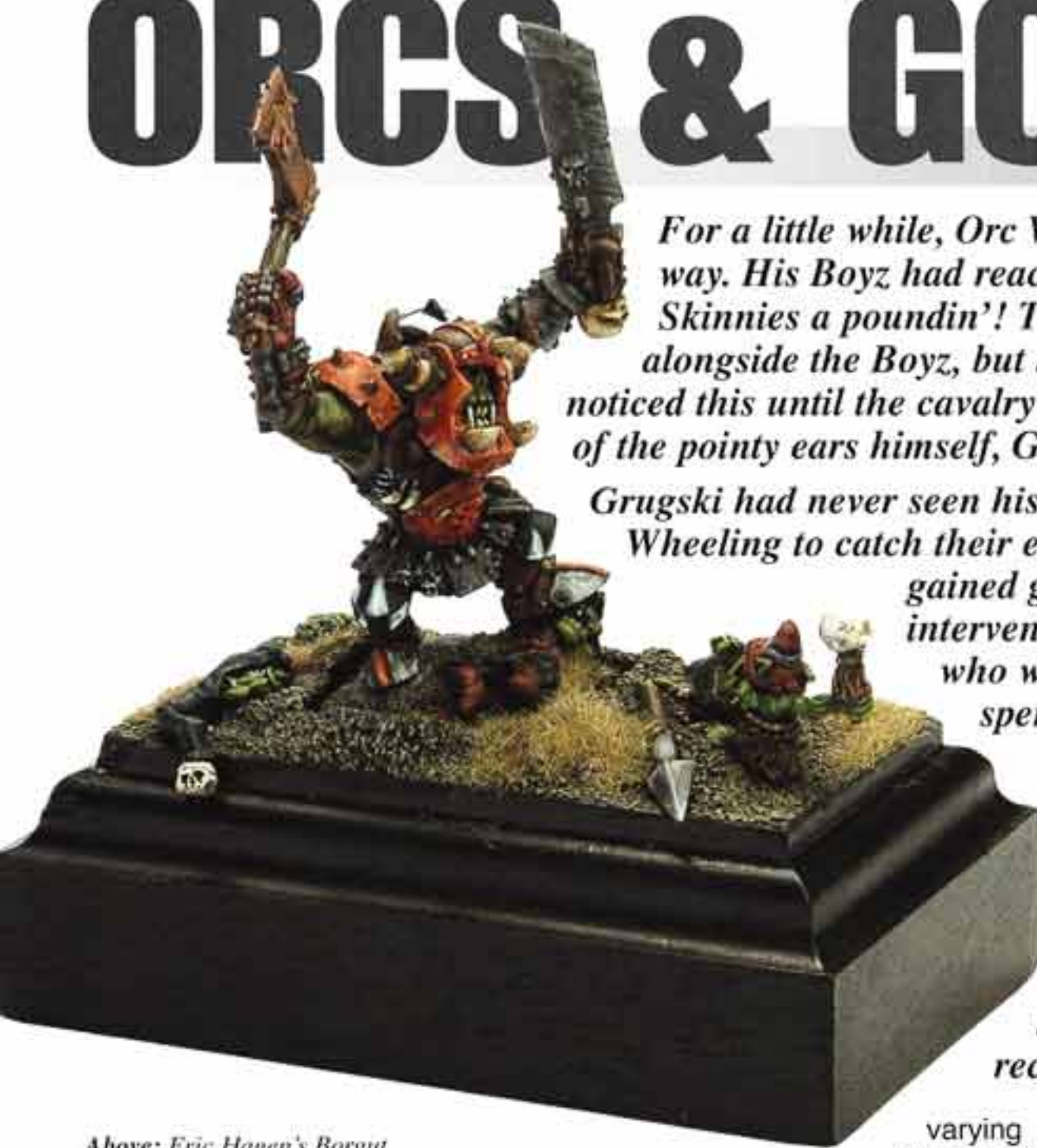

For a little while, Orc Warboss Grugski Skullsplitta had everything going his way. His Boyz had reached the High Elf battle lines and really given them Skinnies a poundin'! The Night Goblin Spearmen were supposed to be right alongside the Boyz, but the little runts must'a run off. Of course, no one noticed this until the cavalry hit the Boyz in the flank. Despite chopping down two of the pointy ears himself, Grugski could not keep his Boyz from leggin' it.

Grugski had never seen his Boyz move so fast as they fled haphazardly to the rear. Wheeling to catch their escaping prey, the High Elven Silver Helms quickly gained ground. All would have been lost but for the timely intervention of the Trolls. The three enormous Stone Trolls, who were supposed to be on the right flank but instead had spent the majority of the battle shuffling stupidly along the empty fields, rose up and battered the oncoming High Elves. In amazement at the fury of the carnage, Grugski and his Boyz held up to watch the last Elf plucked out of his saddle and bitten in two by the inspired Trolls.

"Er, jus' like I planned it, innit?" Grugski suggested strongly to the banner bearer who was sneaking up to reclaim his spot at Grugski's side.

Above: Eric Hagen's Borgut Facebeater was a runner up at the 2004 Chicago Games Day Golden Demon Painting Competition.

Right: Abe Peterka's Night Goblin Hero was a runner up at the 2004 Chicago Games Day Golden Demon Painting Competition.

Orcs & Goblins are war-like creatures that can be found throughout the Warhammer world. Only a powerful leader can unite the disparate mobs of greenskins from various tribes into a cohesive army. Once the internal bickering stops, an Orc & Goblin army is like a massive green tidal wave that crashes across the landscape and leaves only broken destruction and ruin in its wake.

Fighting Style

No other army in Warhammer can match the diverse (but all maniacal) troop types of an Orc & Goblin force. The challenge for the commander is to integrate the wide range of units into a single fighting force. Greenskins suffer from *Animosity* (a rule that forces models from the same army to fight each other) and have many of their own specialty troops and rules. As such, the army tends to stretch out of a commander's hands at some point in nearly every game. Wily generals learn to expect and exploit this battlefield madness rather than trying to control it.

When working correctly, Orcs & Goblins throw an astounding assortment of threats of

varying degrees at the foe. When facing large blocks of Orc Boyz, fast Goblin Wolf Riders on the flanks, and Night Goblins with their hidden Fanatics, the enemy has too many targets. Add in creatures like the tiny Snotlings, who are not hard-hitting but can tie up even the most powerful units, or a mighty Giant that can wipe out even heavily armored Knights, and you compound your enemy's plight. Serious threats like Chariots, Boar Boyz, or Black Orcs are such a menace that often the enemy will concentrate on them, which allows the hordes to rampage unchecked. Successful greenskin Warlords have learned that there is no one sure thing. However, with enough weapons in the arsenal, something is going to get through and smash the enemy! Quantity has a quality all its own. If you can learn to laugh off horrendous casualties, you're well on your way to mastering the greenskin psyche.

Collecting an Orc & Goblin Army

Core units are always great places to start collecting an army, and Orcs & Goblins have a vast selection of troop types to choose from. A few large blocks of Orc Boyz or Goblins (either Night Goblins with their specialty Fanatics or Goblins with their better Leadership) will make for an imposing center that doesn't cost many points. With an endless variety of ways to build an army, a

greenskin Warlord must make some decisions. Overwhelming numbers, lots of fast-striking cavalry, war machines, and shock infantry are all options open to Orcs & Goblins, and it's possible to put a little of each element into a single force.

Black Orcs and Boar Boyz are both formidable units that will be sure to draw a great amount of enemy fire! Trolls, with their ability to *Regenerate*, can pulverize enemy units as long as they overcome their own *Stupidity!* Savage Orcs are subject to *Frenzy*, and Squig Herds can tie up an entire enemy flank with bounding and biting creatures and Squig Hoppers.

When it all works, you'll be the mastermind, but of course, even the best greenskin plans can all go wrong. Your own battle lines can end up mired with in-fighting while the enemy picks them off unit by unit. Unpredictability makes Orcs & Goblins both fun and frustrating. If you aren't prepared to see the total mayhem of your Goblin Fanatics whirling through your own troops, then perhaps Orcs & Goblins aren't the army for you.





Orc & Goblin Battalion Box 99120209005

- 1 Orc Hero
- 9 Orc Boyz Including Command
- 18 Orc Arrer Boyz Including Command
- 1 Orc Boar Chariot
- 10 Goblin Wolf Riders



GETTING STARTED

The 80-page Warhammer Armies: Orcs & Goblins rulebook contains painting and modeling guides, background, and the full rules for fielding an army of Orcs & Goblins.

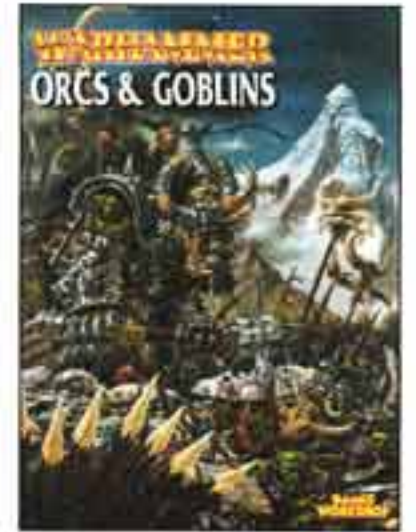

Warhammer Armies:
Orcs & Goblins
60030209001



GOBLIN SHAMAN
9947020911701

Goblin Shaman Blister (2)
99060209117



NIGHT GOBLIN SHAMAN BODY
9947020905001



NIGHT GOBLIN SHAMAN STAFF
9947020905002



Orc Shaman Blister (1)
99060209049



ORC SHAMAN BODY
9947020904903



LORDS & HEROES



Savage Orc Shaman Blister (1)
99060209132



SAVAGE ORC SHAMAN BODY
9947020913201



ORC SHAMAN SWORD
9947020904901



ORC SHAMAN STAFF
9947020904902



SAVAGE ORC SHAMAN JU JU STICK
9947020913203



SAVAGE ORC SHAMAN HEAD
9947020913202





LORDS & HEROES

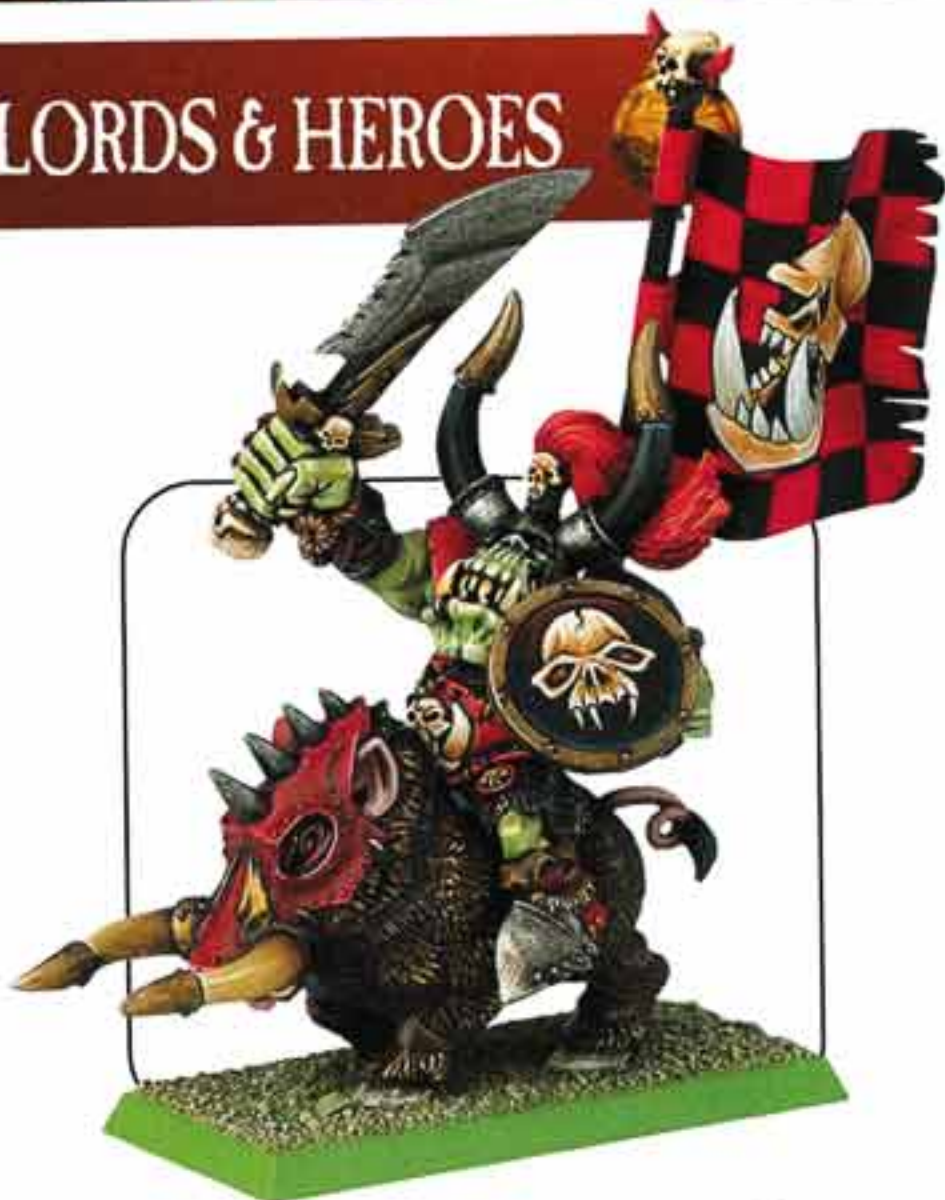

Orc Warlord on Boar Blister (1)
99060209048

The Orc Warlord on Boar comes with the Boar Body Sprue (99389999009) shown below.



ORC WARLORD HEAD
9947020904802



ORC WARLORD SWORD ARM
9947020904803



ORC WARLORD BODY
9947020904801

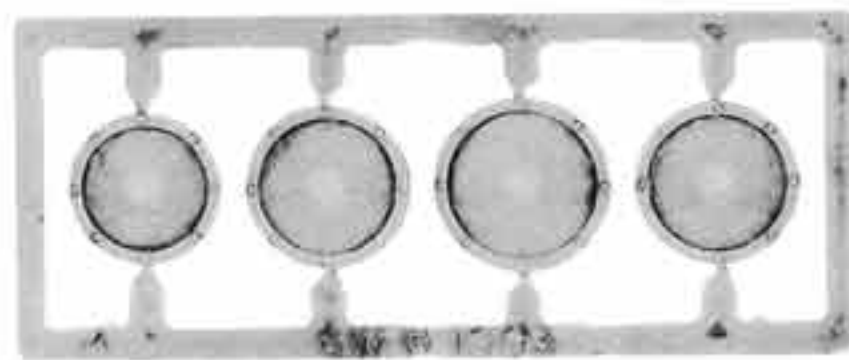

LARGE SHIELD SPRUE
99369999006



ORC WARLORD BANNER POLE
9947020904804



ORC WARLORD BOAR HEAD
9947020904805



ORC WARLORD BOAR TUSKS
9947020904806



BOAR TAIL SPRUE
9947020901107



Orc Shaman on Boar Blister (1)
99060209143



ORC SHAMAN HEAD 1
9947020914301



ORC SHAMAN HEAD 2
9947020914302



ORC SHAMAN MTD BODY
9947020914303



ORC SHAMAN MTD BANNER
9947020914304



ORC SHAMAN BOAR HEAD
9947020914305

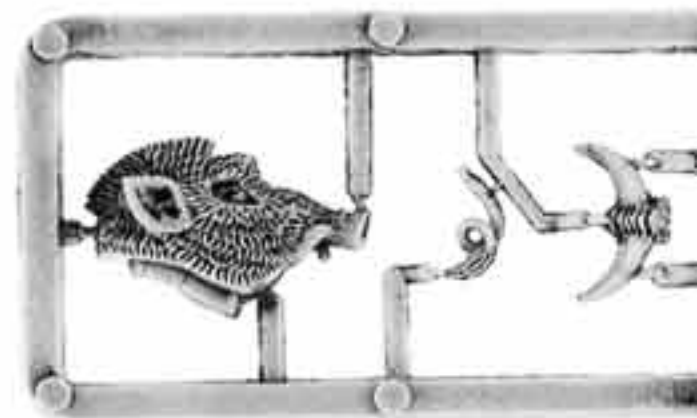

BOAR HEAD SPRUE
99389999017



BOAR BODY SPRUE
99389999009

LORDS & HEROES



Orc Warboss on Wyvern Box (1)
99110209119



ORC WYVERN TAIL
9947020911908

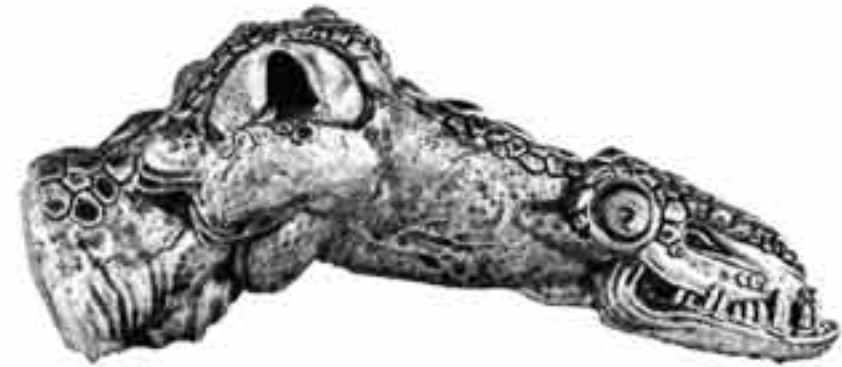

ORC WYVERN BODY & HEAD
9947020911907



ORC WYVERN LEG
9947020911909



ORC WYVERN LOWER BODY
9947020911910



ORC WYVERN HORNS
9947020911906



DRAGON WING SET SPRUE
99380299002



ORC WARBOSS SHIELD
9947020911905



ORC WARBOSS HEAD
9947020911904



ORC WARBOSS AXE
9947020911902



ORC WARBOSS HORNS
9947020911903



ORC WARBOSS BODY
9947020911901



LORDS & HEROES



Wurrzag comes with the Boar Body Sprue (99389999009) and the Boar Head Sprue (99389999017) shown with the Orc Shaman on Boar.



Grimgor Ironhide, Black Orc Warlord Blister (1)
99060209121



Borgut Facebeater, Black Orc Champion Blister (1)
99060209144



Wurrzag Ud Ura Zahubu, Great Shaman Blister (1)
99060209133



GRIMGOR'S HEAD
9947020912103



BORGUT FACEBEATER HEAD 1
9947020914401



BORGUT FACEBEATER HEAD 2
9947020914402



WURZAG HEAD & MASK
9947020913303



GRIMGOR'S AXE
9947020912102



BORGUT FACEBEATER AXE
9947020914404



WURZAG HAND
9947020913302



GRIMGOR'S BODY
9947020912101



BORGUT FACEBEATER BODY
9947020914403



WURZAG BODY
9947020913301



CORE UNITS

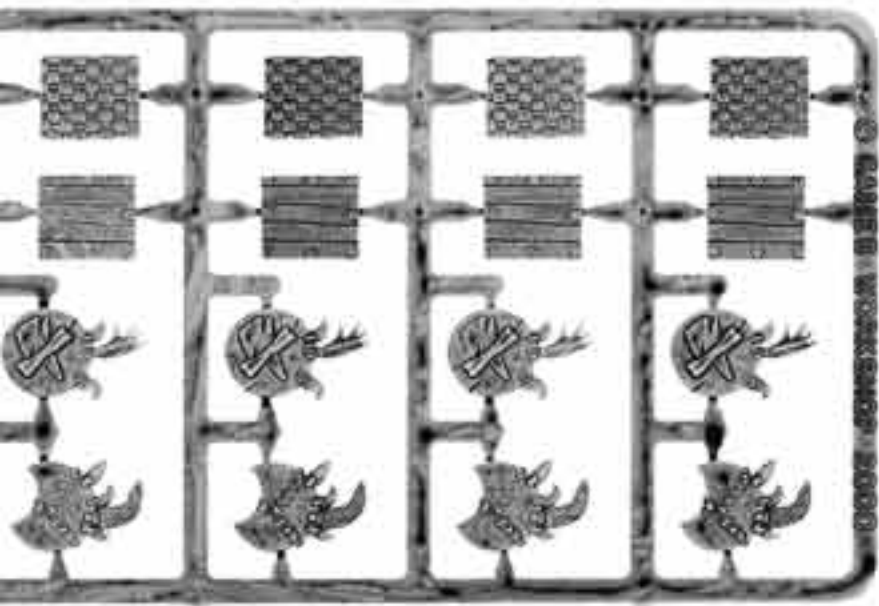

GOBLIN SHIELD SPRUE (SHOWN 80% ACTUAL SIZE)
99360209001



Goblin Regiment Box (20)
99120209002

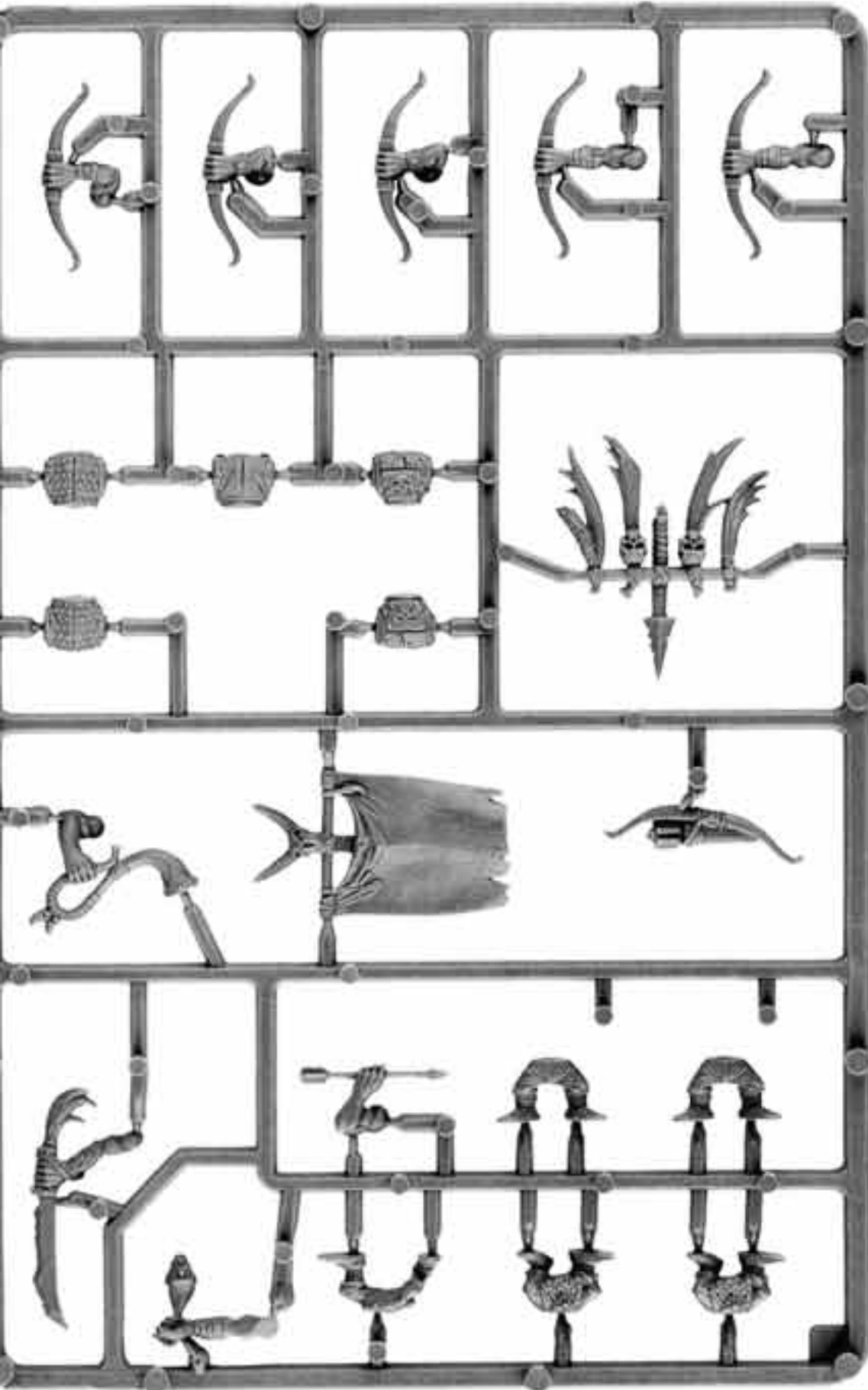

GOBLIN SPRUE A (SHOWN 70% ACTUAL SIZE)
99380209005

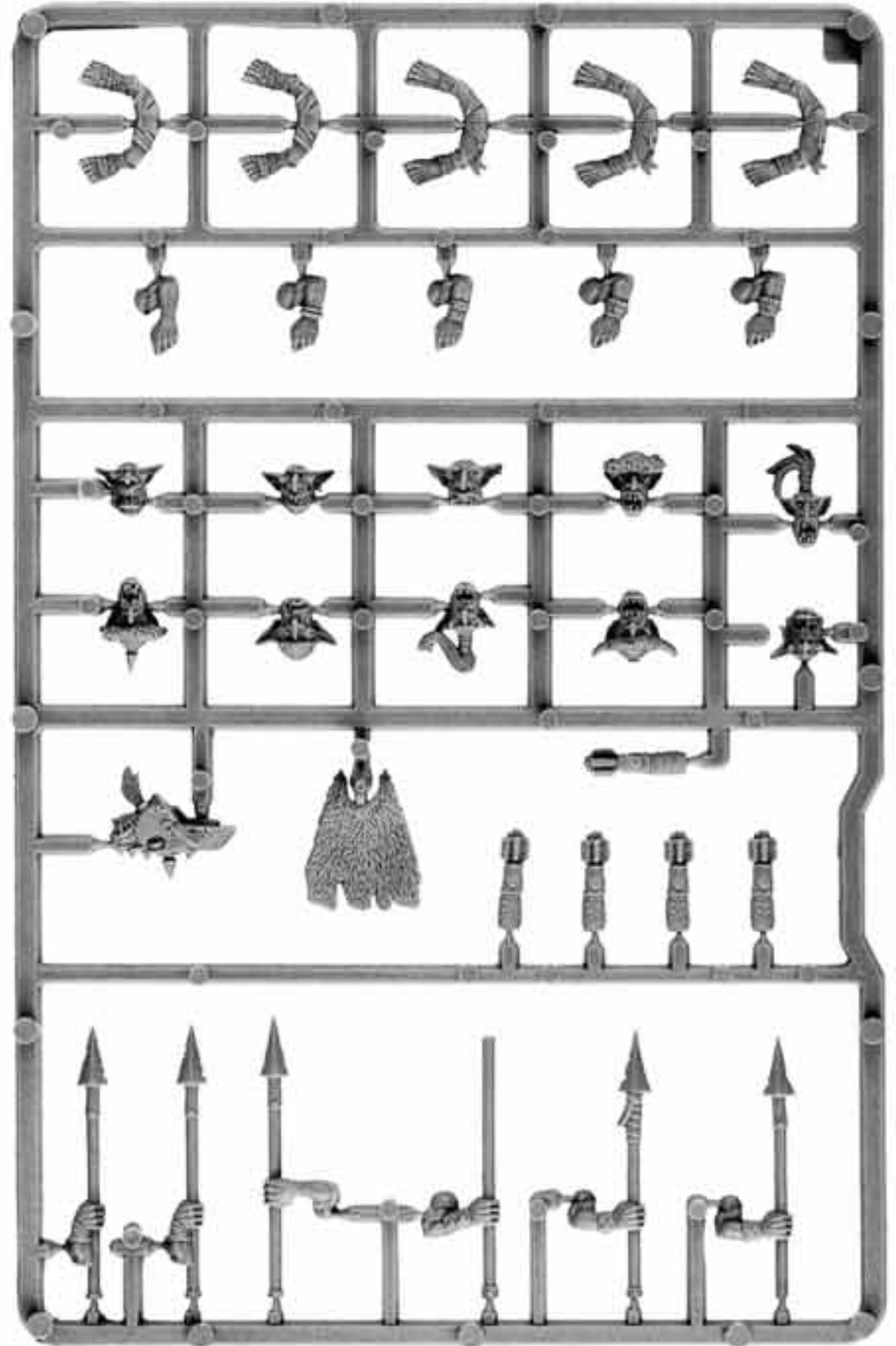

GOBLIN SPRUE B (SHOWN 70% ACTUAL SIZE)
99380209006



CORE UNITS



Night Goblin Regiment Box (20)
99120209003

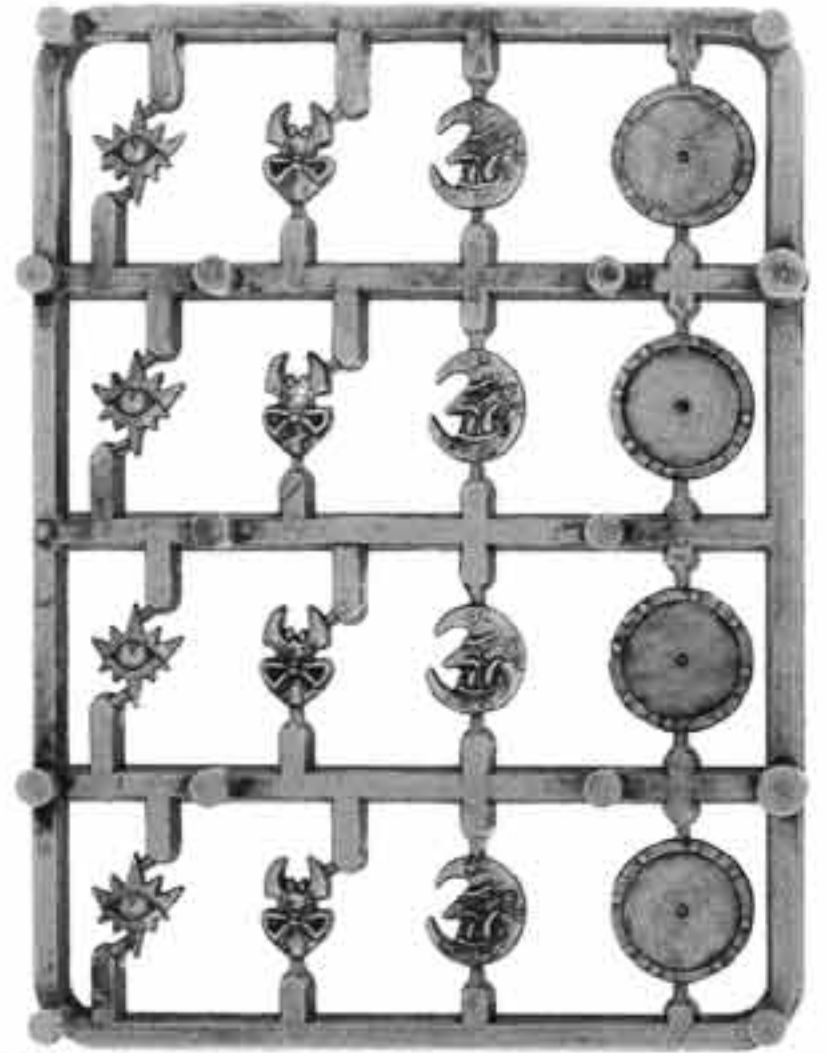

NIGHT GOBLIN SHIELD SPRUE (SHOWN 90% ACTUAL SIZE)
99360299005

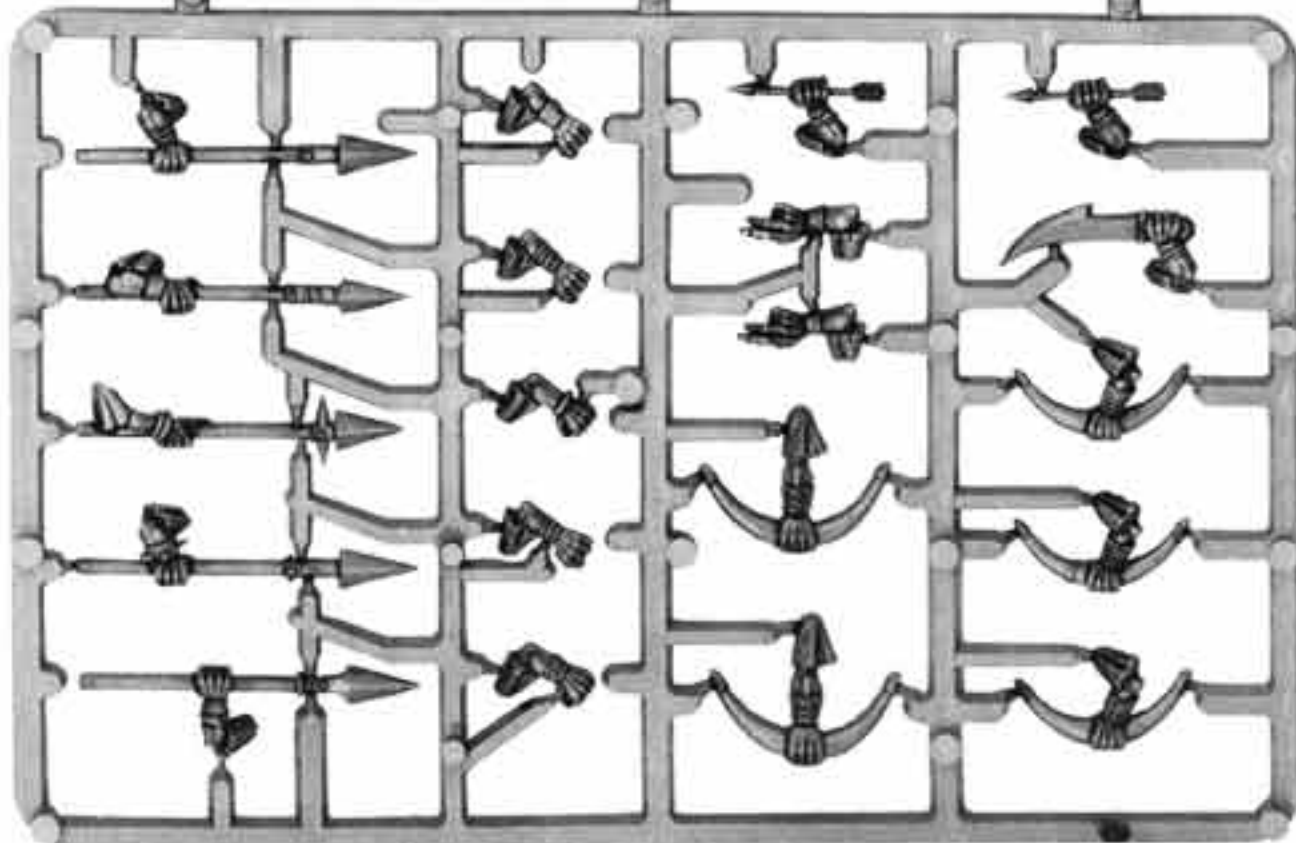
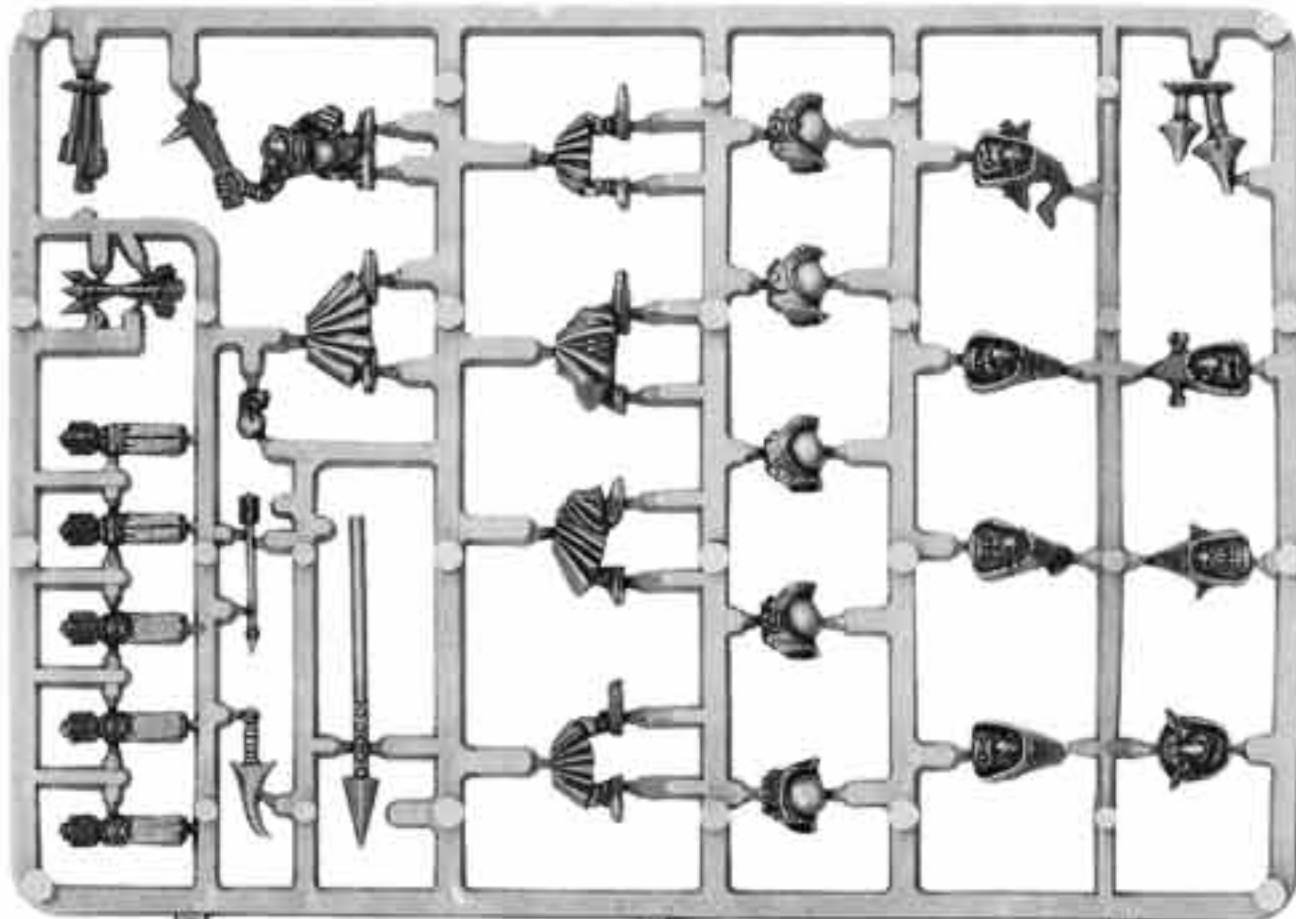

NIGHT GOBLIN REGIMENT SPRUE (SHOWN 65% ACTUAL SIZE)
99380209001

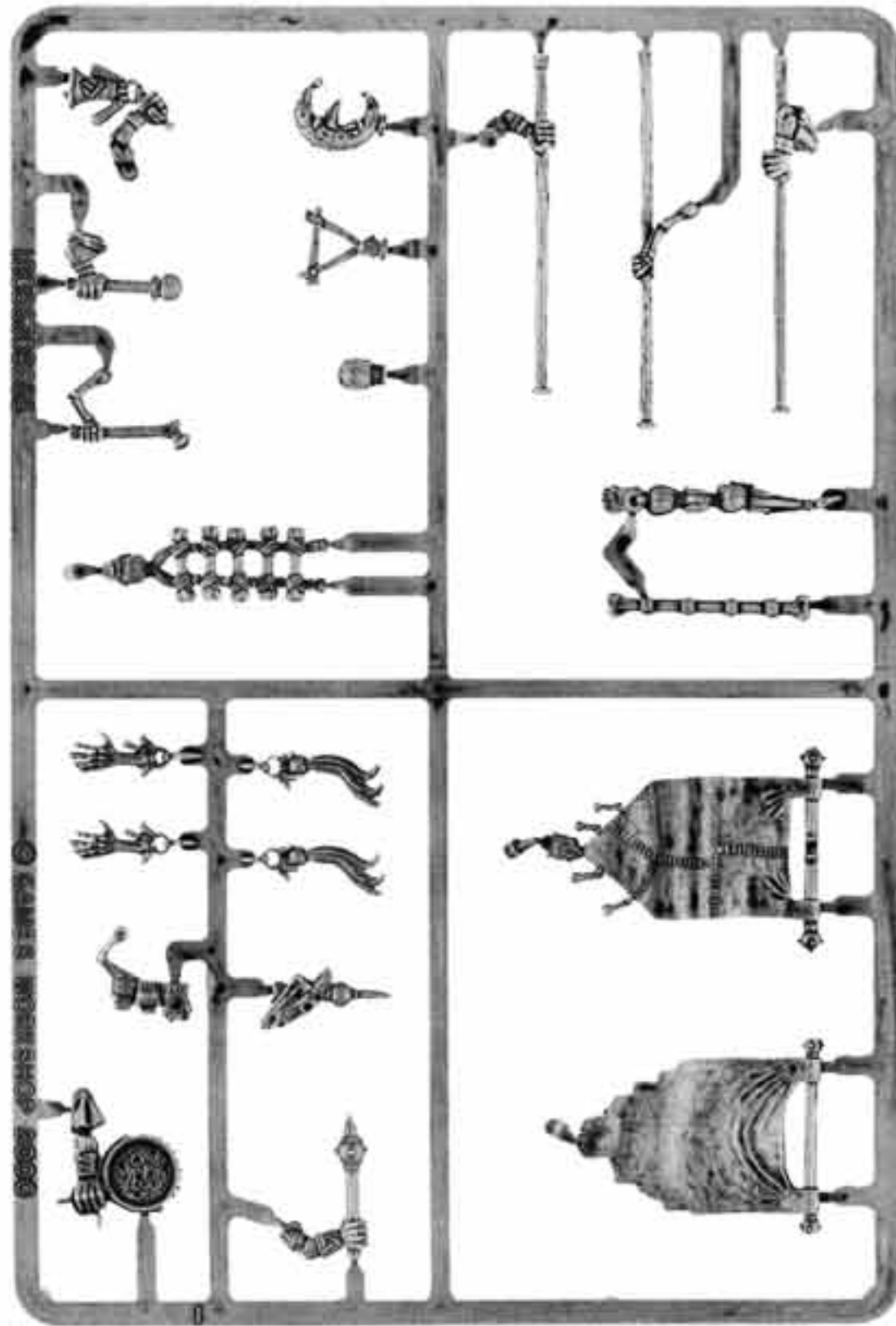

REGIMENT COMMAND SPRUE (SHOWN 65% ACTUAL SIZE)
99380299001

CORE UNITS



Night Goblin Fanatics Blister (Random 3)
99060209058

PAINTING TEEF, HORNS & CLAWS

From Snotlings to Giants, everything in the Orc & Goblin army has some type of bony or enamel body parts: teef, nails, horns, or claws. Here's a quick way to paint them so that all the models in your army look ferocious and hungry!



STEP 1

To begin, prime the entire model with Chaos Black. This will be the base color.

STEP 2



Paint a layer of Bestial Brown across all the teeth, horns, and claws. Leave a small line of black around each of the edges.

STEP 3



Paint a layer of Bubonic Brown over the Bestial Brown. Paint the Bubonic Brown with a slightly jagged edge at the base of each tooth, horn, and claw.

STEP 4



Repeat Step 3 but use Bleached Bone instead of Bubonic Brown. You can stop here for a dirtier, nastier look for the teeth.

STEP 5

Add a final highlight with Skull White on each of the teeth, horns, and claws.



NIGHT GOBLIN FANATIC 1 BODY
9947020905801



NIGHT GOBLIN FANATIC 2 BODY
9947020905803



NIGHT GOBLIN FANATIC 1 BALL & CHAIN
9947020905802



NIGHT GOBLIN FANATIC 2 BALL & CHAIN
9947020905804



NIGHT GOBLIN FANATIC 3 BALL & CHAIN
9947020905806



NIGHT GOBLIN FANATIC 4 BALL & CHAIN
9947020905808



NIGHT GOBLIN FANATIC 3 BODY
9947020905805



NIGHT GOBLIN FANATIC 4 BODY
9947020905807



NIGHT GOBLIN NETTER 1
9947020912903



NIGHT GOBLIN NETTER 2
9947020912901



NIGHT GOBLIN NETTER 3
9947020912902

Night Goblin Netters Blister (3)
99060209129

CORE UNITS



This alternate sprue for the Orc Boyz is available only via Special Offer.

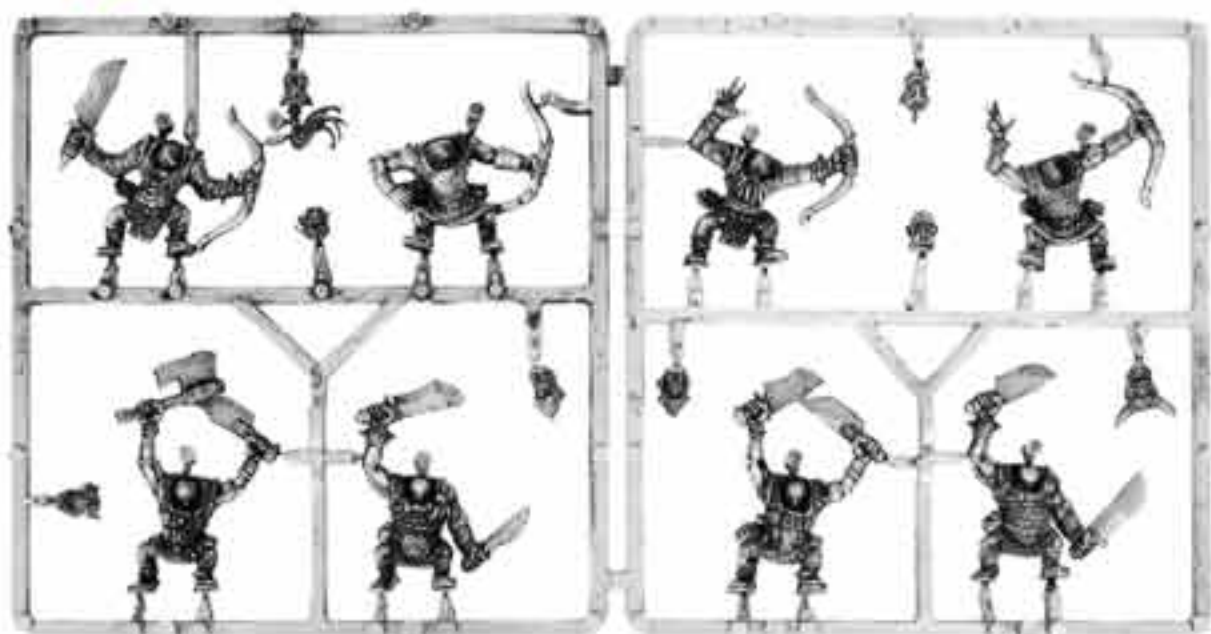

ORC BOYZ/ARRER BOYZ SPRUE (SHOWN 30% ACTUAL SIZE)
99380209004

Orc Boyz Regiment Box (19)
99120209001

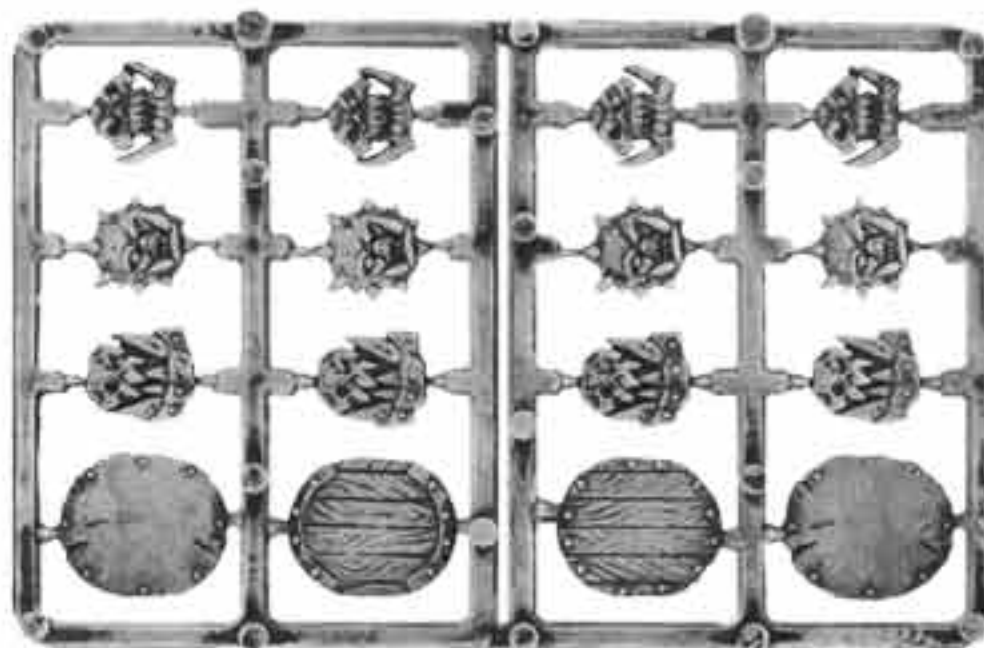

ORC REGIMENT SHIELD SPRUE (SHOWN 80% ACTUAL SIZE)
99360299004

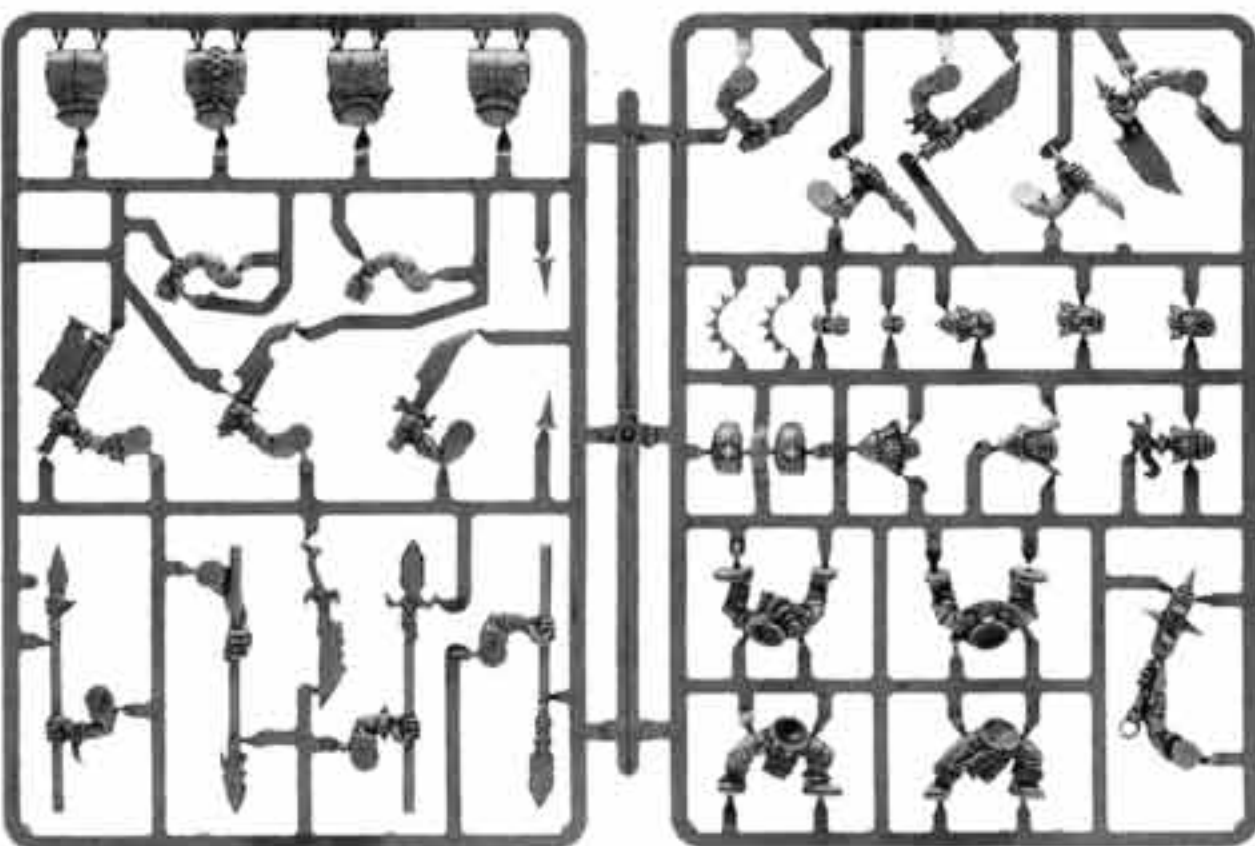

ORC REGIMENT SPRUE (SHOWN 45% ACTUAL SIZE)
99380209002

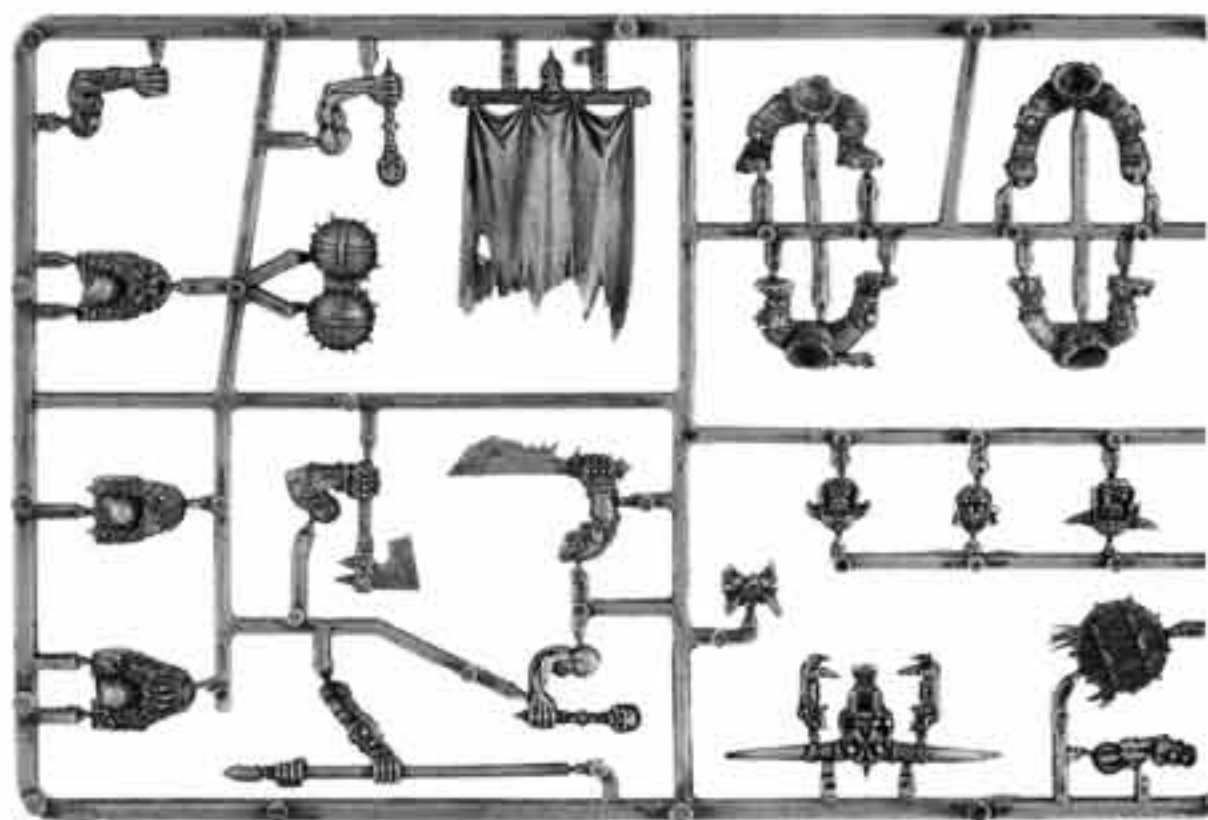

ORC COMMAND SPRUE (SHOWN 45% ACTUAL SIZE)
99380209003



Savage Orc Boyz Box (10) & Savage Orc Boyz Command Blister (3)
99110209147 99060209131



SAVAGE ORC 1
9947020912001



SAVAGE ORC 3
9947020912003



SAVAGE ORC STANDARD BEARER TOP
9947020913106



SAVAGE ORC CHAMPION ARM
9947020913101



SAVAGE ORC 2
9947020912002



SAVAGE ORC 4
9947020912004



SAVAGE ORC CHAMPION HEAD
9947020913103



SAVAGE ORC STANDARD BEARER
9947020913105



SAVAGE ORC MUSICIAN
9947020913104



SAVAGE ORC CHAMPION BODY
9947020913102



CORE UNITS

PAINTING EXOTIC FUR

When painting the fur clothing on your Savage Orcs, try some exotic animal furs with stripes or spots!

TIPS

Search for some reference photos in magazines, in books, or on the internet and have them handy while you're painting. Animals to look for include zebras, leopards, cheetahs, tigers, giraffes, cows, and more!



SNOW LEOPARD SPOTS



Step 1. First, paint the underlying fur with Fortress Grey. Drybrush the fur with Skull White as a highlight.



Step 2. Next, paint a large "U" with Chaos Black. Repeat them all over the fur.



Step 3. Finally, highlight the black spots with a 25/75 mix of Chaos Black and Codex Grey.

TIGER STRIPES



Step 1. First, paint the underlying fur with Blazing Orange over Dark Flesh. Drybrush the fur with Fiery Orange as a highlight.



Step 2. Using Chaos Black, paint a series of stripes on the fur.



Step 3. Finally, highlight the stripes with a 25/75 mix of Chaos Black and Codex Grey.

CORE UNITS

PAINTING WOLVES

Wolves are used throughout the Orc & Goblin army both as mounts and as beasts to pull Chariots. Try some of these techniques for painting the fur on your Wolves.

BROWN FUR



Step 1. After you prime the model Chaos Black, drybrush Scorched Brown over all of the fur.



Step 2. Next, drybrush the fur Bestial Brown.



Step 3. Drybrush the higher parts of the fur with Vomit Brown. Paint the fur of the belly with Codex Grey and the claws and teeth with Bubonic Brown. Use a 50/50 mix of Scab Red and Dwarf Flesh for the tongue. Wash the entire model with Flesh Wash. Paint the Wolf's eye with Skull White.



Step 4. Drybrush under the belly with Fortress Grey. Paint the gums

and teeth with Dwarf Flesh. Finish off the teeth and claws with Bleached Bone.

BLONDE FUR



Step 1. After you prime the model Skull White, paint it Bubonic Brown.



Step 2. Next, use Flesh Wash over the entire model.



Step 3. Drybrush the fur with a 50/50 mix of Bubonic Brown and Bleached Bone. Paint the teeth, claws, tongue, and eyes as described above.



Step 4. Drybrush the highest parts of the fur with Bleached Bone.

BLONDE ALTERNATE

Use a Brown Wash instead of the Flesh Wash. Paint the skin and drybrush the fur with a 50/50 mix of Bubonic Brown and Bleached Bone. Paint the belly with Bleached Bone and drybrush with Skull White. Highlight the skin with Bleached Bone.



Goblin Wolf Riders Regiment Box (10)

99120209004

Goblin Wolf Riders come with the Goblin Sprue A & B (99380209005&6) and the Goblin Shield Sprue (99360209001) shown with the Goblin Regiment.

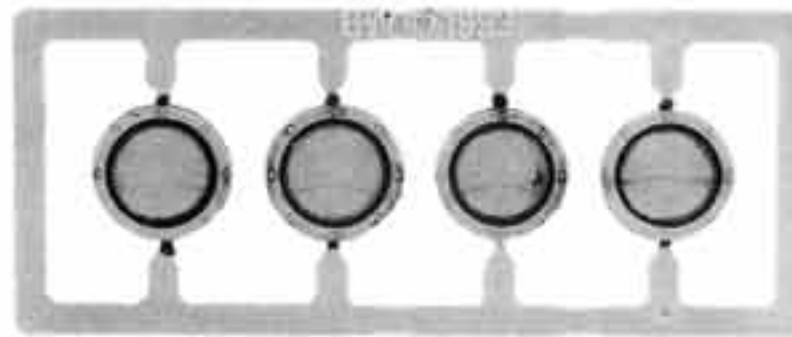

SMALL ROUND SHIELD SPRUE
99369999004



© GW 1992



© GW 1992

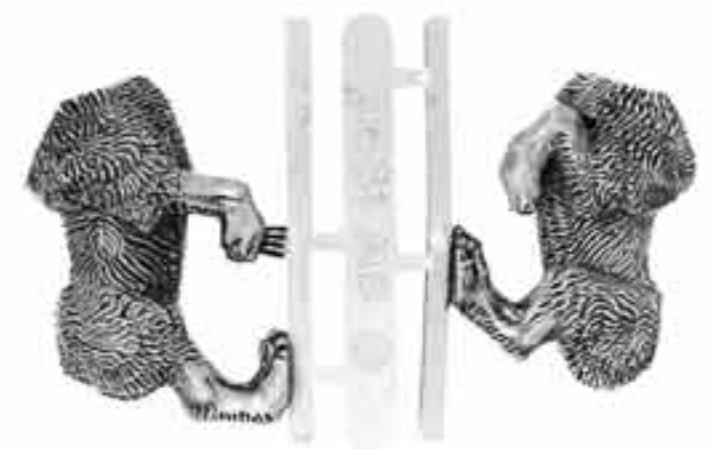

WOLF HEAD & BODY SPRUE (RANDOM 1)
99380299005

CORE UNITS



SNOTLING 1



SNOTLING 2



SNOTLING 5



SNOTLING 16



SNOTLING 3



SNOTLING 4



SNOTLING 6



SNOTLING 7



Snotlings Blister (Random 2 Bases)
99060209142

Snotlings are available only in their randomly packed blister.



SNOTLING 8



SNOTLING 9



SNOTLING 17



SNOTLING 18



SNOTLING 19



SNOTLING 20



SNOTLING 21

Goblin Wolf Chariot comes with Wolf Head & Body Sprue (99380299005) shown on the opposite page.



GOBLIN CHARIOT YOKE
9947020900301



GOBLIN CHARIOT HAFT
9947020900302



SPECIAL UNITS



SOLID WAGON WHEEL SPRUE
99399999058



GOBLIN CHARIOT SIDE 1
9947020900310



GOBLIN CHARIOT SIDE 2
9947020900310

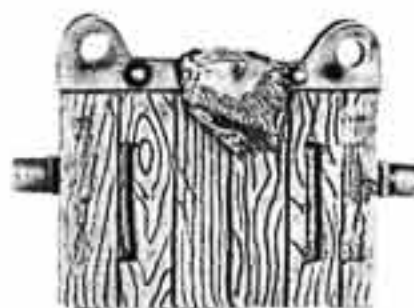

GOBLIN CHARIOT CHASSIS
9947020900308



GOBLIN CHARIOT LEFT SCYTHE
9947020900303



GOBLIN CHARIOT RIGHT SCYTHE
9947020900304

Goblin Wolf Chariot Box (1)
99110209003



GOBLIN CHARIOT STANDARD BEARER
9947020900311



GOBLIN CHARIOT ARCHER
9947020900313



GOBLIN CHARIOT DRIVER
9947020900312



GOBLIN CHARIOT STANDARD TOP
9947020900307



GOBLIN CHARIOT TAIL & SKULLS 1
9947020900305



GOBLIN CHARIOT TAIL & SKULLS 2
9947020900306

SPECIAL UNITS



SQUIG HOPPER 1
9947020913001

SQUIG HOPPER 2
9947020913002

SQUIG HOPPER 3
9947020913003

SQUIG HOPPER 4
9947020913004

**Night Goblin Squig Hoppers
Blister (Random 2)**
99060209130



**NIGHT GOBLIN
W/ PRODDER 1**
9947020912801



**NIGHT GOBLIN
W/ CYMBALS**
9947020912803



SQUIG 1
9947020912805



**NIGHT GOBLIN
W/ PRODDER 2**
9947020912802



**NIGHT GOBLIN
W/ SQUIGPIPES**
9947020912804



SQUIG 2
9947 020912806



SQUIG 3
9947020912807



SQUIG 4
9947020912808



SQUIG 5
9947020912809



SQUIG 6
9947020912810

Night Goblin Squig Herders Blister (Random 5)
99060209128



Goblin Spear Chukka Blister (1)
99060209118



**SPEAR CHUKKA
CREW 1**
9947020911801



**SPEAR CHUKKA
CREW 2**
9947020911802



**SPEAR CHUKKA
CREW 3**
9947020911803



SPEAR CHUKKA REAR SUPPORT
9947020911806



SPEAR CHUKKA FRONT SUPPORT
9947020911808



SPEAR CHUKKA HANDLES
9947020911809

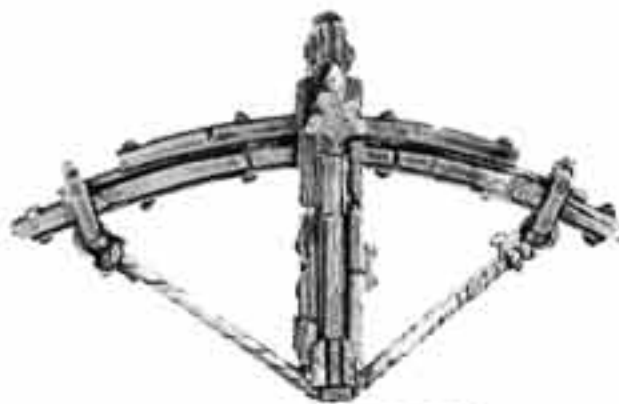

SPEAR CHUKKA BOW
9947020911805



SPEAR CHUKKA STOCK
9947020911807



SPEAR CHUKKA FAIRING
9947020911804

SPECIAL UNITS



Goblin Rock Lobba Box (1)
99110209123



ROCK LOBBA
SNOTLING SPOTTER
9947020912307



ROCK LOBBA
COUNTER BALANCE
9947020912309



ROCK DROPPER
BOULDER
9947029901009



ROCK LOBBA CREW 1
9947020912301



ROCK LOBBA CREW 2
9947020912302



ROCK LOBBA CREW 3
9947020912306



ROCK LOBBA STRUT
9947020912310



ROCK LOBBA WINCH
9947020912303



ROCK LOBBA BULLY
9947020912304



ROCK LOBBA UPRIGHTS
9947020912305

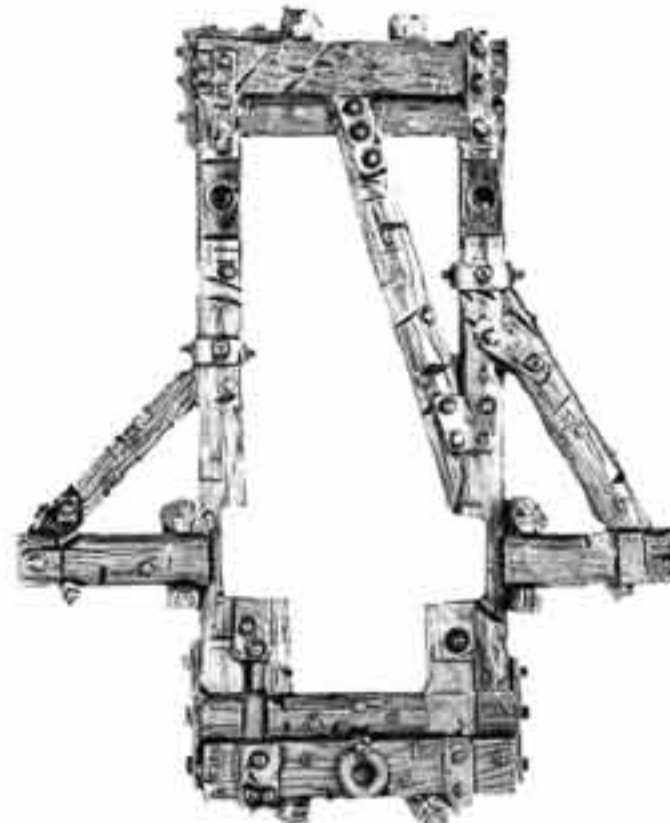

ROCK LOBBA BASE
9947020912308



ROCK LOBBA ARM
9947020912311

SPECIAL UNITS

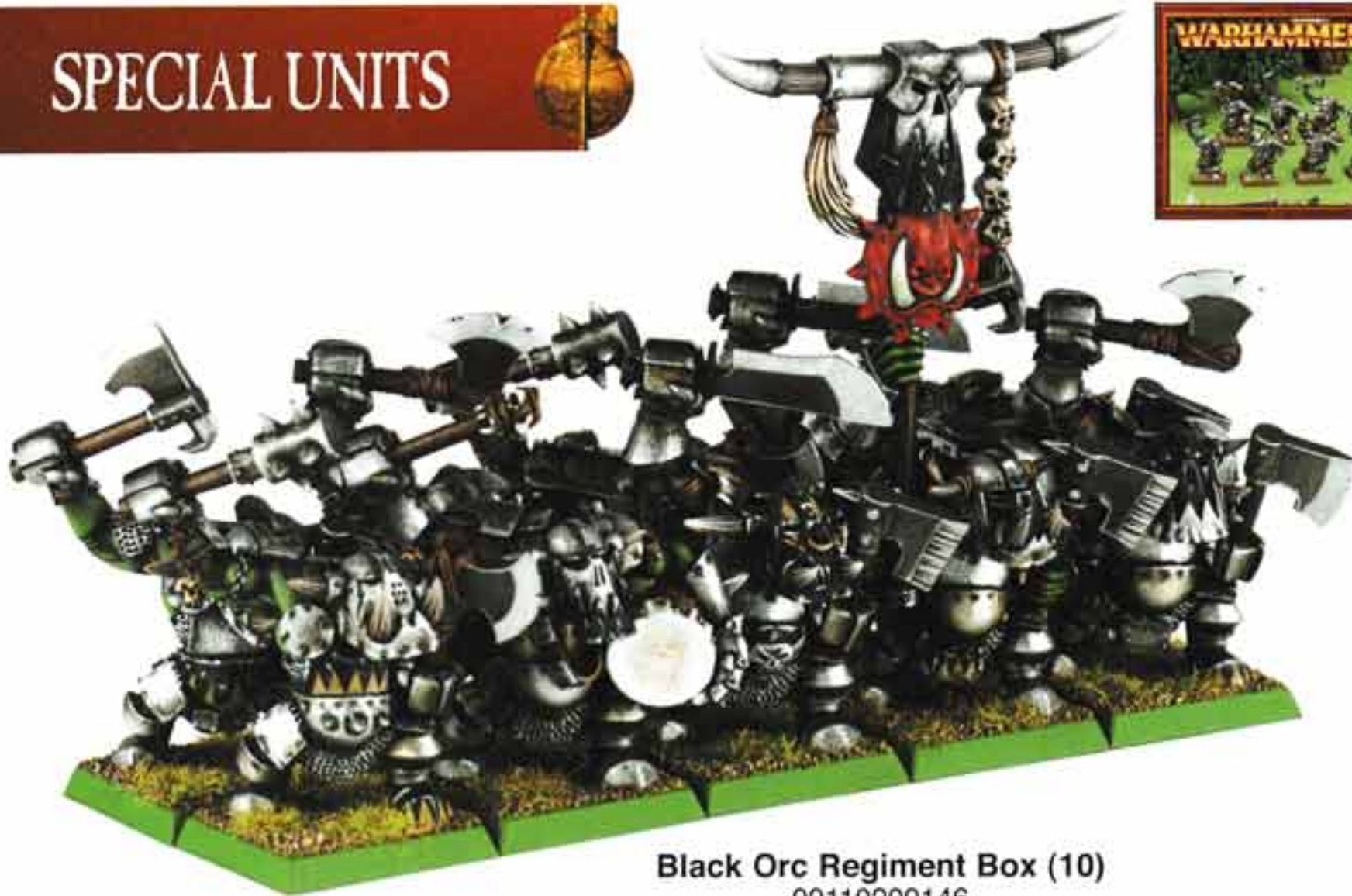

BLACK ORC HEAD SPRUE 1
9947020911505



BLACK ORC HEAD SPRUE 2
9947020911506

Black Orc Regiment Box (10)
99110209146

Black Orc Command Blister (2)
99060209149



This alternate bit for the Black Orcs is available only via Special Offer.



BLACK ORC STANDARD TOP
9947020911602



BLACK ORC STANDARD TOP 2
9947020914901



BLACK ORC DRUMMER
9947020911601



BLACK ORC STANDARD BEARER
9947020911603



BLACK ORC BODY 1
9947020911501



BLACK ORC BODY 2
9947020911502



BLACK ORC BODY 3
9947020911503



BLACK ORC BODY 4
9947020911504

Black Orc with Great Weapon Regiment comes with Black Orc Head Sprue 1 & 2 (9947020911505&6) shown on the opposite page.



Black Orc w/ Great Weapon Regiment Box (10)
99110209148



BLACK ORC
W/ GREAT WEAPON 1
9947020914801



BLACK ORC
W/ GREAT WEAPON 2
9947020914802



BLACK ORC
W/ GREAT WEAPON 3
9947020914803



BLACK ORC
W/ GREAT WEAPON 4
9947020914804

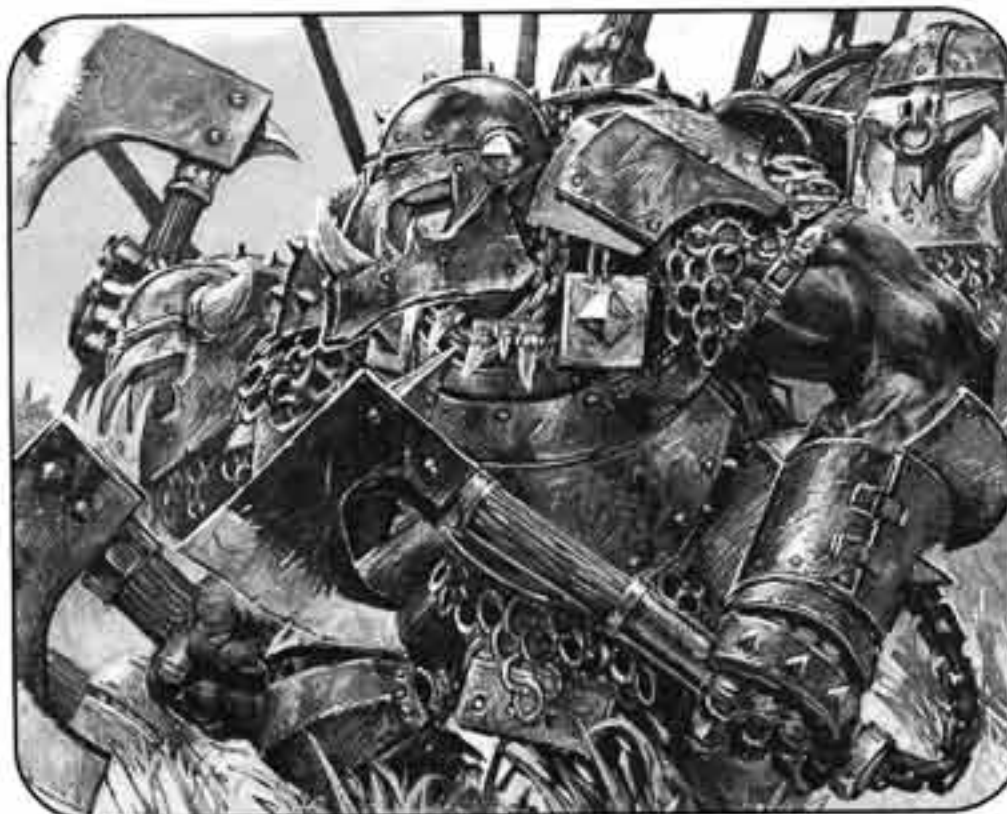

SPECIAL UNITS

PAINTING TRIBAL MARKINGS

There are hundreds of Orc tribes across the Old World. Some of the more popular names are:

- Blue Face
- Yellow Nose
- Purple Heads
- Yellow Tooth
- Red Arrow
- Grey Skull
- Brown Sword
- White Dag (triangle)



These are just a few. No matter which you choose, we recommend picking a single color and a simple design to paint such as dags or arrows. Tattoos don't have to be intricate tiny designs, especially for Orcs & Goblins.

You can also be creative with the location of the tattoos and war paint. They can be on Boar and Wolf fur, on half of a face, on an entire arm or hand, in a wide line across the head or arm, or on any other body part!

ORCS OF THE RED ARROW TRIBE

Here is a simple technique for painting dark tattoos or war paint onto Orc skin or even on Boars or Wolves.



Step 1
Paint the arrow design on the Orc's upper arm with Chaos Black.

Step 2
Highlight the arrow with Red Gore or a dark color of your choice, such as Regal Blue. Leave a black line around the edges.

Step 3
Paint the final highlight on the inside of the arrow with Blood Red or a lighter version of the previous color used, such as Enchanted Blue.



SPECIAL UNITS



Orc Boar Boyz Regiment Box (5)
99110209145

The Orc Boar Boyz Regiment comes with the Boar Body Sprue (99389999009) and Boar Head Sprue (99389999017) shown in HQ and the Orc Regiment Shield Sprue (99360299004) shown in Core Units.



ORC BOAR BOY MUSICIAN ARM 1
9947020902102



ORC BOAR BOY SPEAR 1
9947020904005



ORC BOAR BOY STANDARD ARM
9947020912601



ORC BOAR BOY SPEAR 2
9947020904006



ORC BOAR BOY BOSS
9947020902201



ORC BOAR BOY MUSICIAN ARM 2
9947020912602



ORC BOAR BOY SPEAR 3
9947020904007



ORC BOAR BOY BODY 1
9947020904001



ORC BOAR BOY BODY 2
9947020904002



ORC BOAR BOY BODY 3
9947020904003



ORC BOAR BOY BODY 4
9947020904004

SPECIAL UNITS



Orc Boar Chariot Box (1)
99120209006

The Orc Boar Chariot comes with the Boar Body Sprue (99389999009) and Boar Head Sprue (99389999017) shown in HQ.

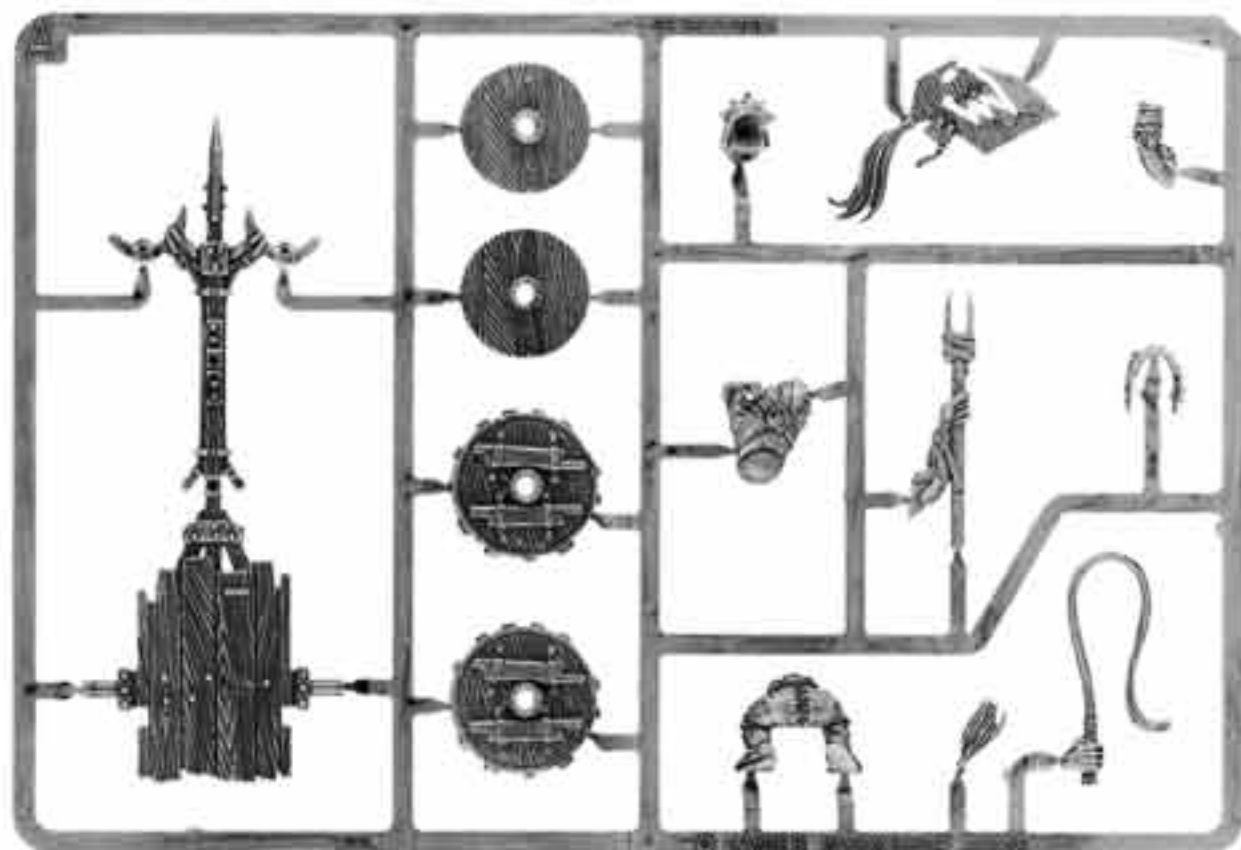

ORC CHARIOT SPRUE A (SHOWN 50% ACTUAL SIZE)
99390209001

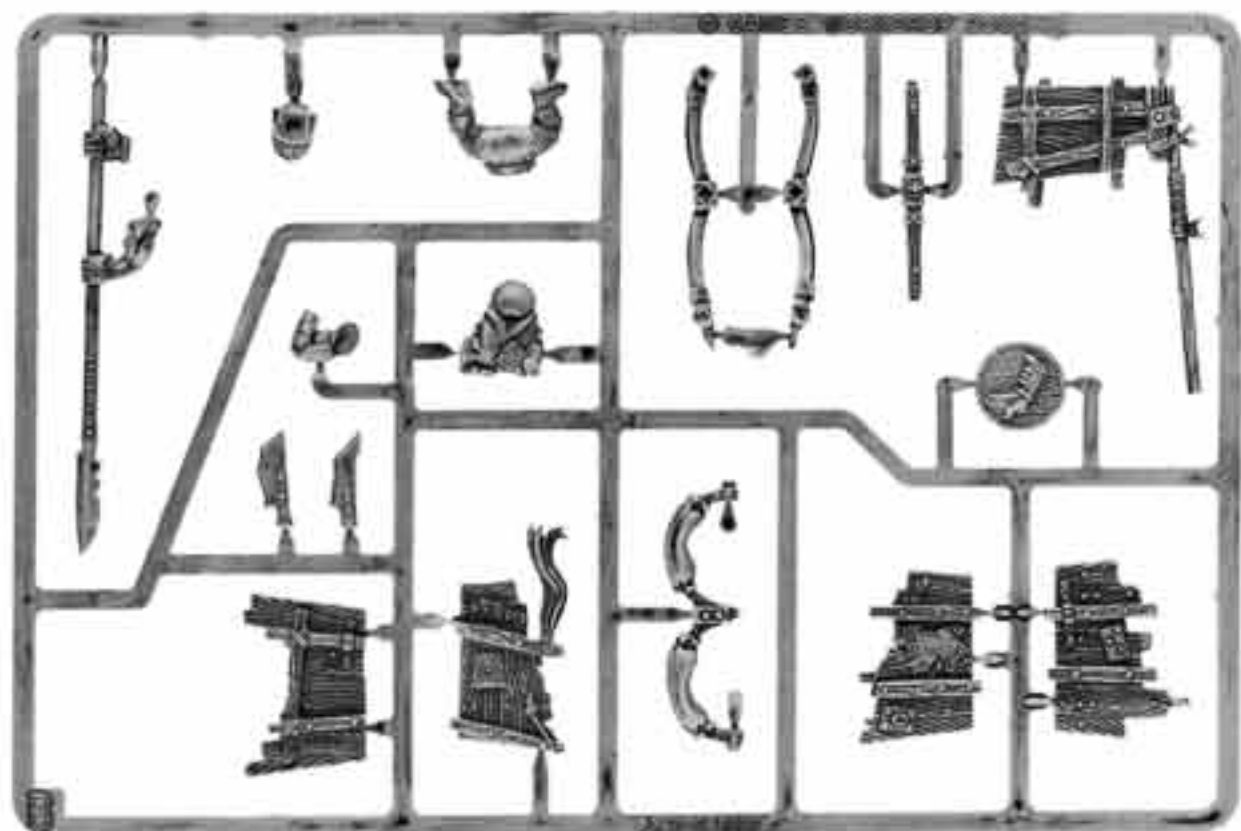

ORC CHARIOT SPRUE B (SHOWN 50% ACTUAL SIZE)
99390209002

PAINTING BOAR FUR

We used Boars for this example, but you can easily use these techniques on Wolves as well. Don't be afraid to experiment with colors and techniques. If you mess up, just give the area a wash and repaint it. Keep in mind that Orc Boars are often penned up. Thus, they are usually filthy. This fact allows you some painting freedom. You can also borrow ideas from the Dwarf section on painting beards!

GREY FUR



Step 1
Spray the model black and drybrush with Shadow Grey followed by Codex Grey.



Step 2
Next, drybrush Fortress Grey onto the higher parts of the model.



Step 3
Finally, gently drybrush skull white onto the highest areas.

BROWN FUR



Step 1
Prime the model white and paint it with a slightly thinned mix of Dark Flesh.



Step 2
Wash the model with Chaos Black.



Step 3
Once dry, drybrush the "higher" parts with Dark Flesh and then Vermin Brown.



Step 4
Finally, gently drybrush Blazing Orange onto the highest areas.

TAN FUR

Prime the model with Skull White and paint it with slightly thinned Bubonic Brown. Give the model a wash of a 50/50 mix of Bubonic Brown and Bestial Brown. Once dry, use Bubonic Brown to drybrush the higher parts of the model with Bleached Bone. Finally, gently drybrush Skull White onto the highest areas.



SPECIAL UNITS



Savage Orc Boar Boyz come with the Boar Body Sprue (99389999009) and Boar Head Sprue (99389999017) shown in HQ.



Savage Orc Boar Boy Blister (Random 1)
99060209135

Savage Orc Boar Boy Command Blister (Random 1)
99060209134



Savage Orc Boar Boy Regiment Box (5)
99110209135

SAVAGE ORC BOAR BOY CHAMPION ARM
9947020913409



SAVAGE ORC BOAR BOY STANDARD POLE
9947020913410



SAVAGE ORC BOAR BOY STANDARD TOP
9947020913408



SAVAGE ORC BOAR BOY COMMAND HEAD 1
9947020913403



SAVAGE ORC BOAR BOY COMMAND HEAD 2
9947020913402



SAVAGE ORC BOAR BOY COMMAND HEAD 3
9947020913401



SAVAGE ORC BOAR BOY SPEAR 2
9947020913510



SAVAGE ORC BOAR BOY HORN
9947020913407



SAVAGE ORC BOAR BOY COMMAND BODY 1
9947020913404



SAVAGE ORC BOAR BOY COMMAND BODY 2
9947020913405



SAVAGE ORC BOAR BOY COMMAND BODY 3
9947020913406



SAVAGE ORC BOAR BOY SPEAR 1
9947020913509



SAVAGE ORC BOAR BOY HEAD 1
9947020913501



SAVAGE ORC BOAR BOY HEAD 2
9947020913502



SAVAGE ORC BOAR BOY BODY 1
9947020913505



SAVAGE ORC BOAR BOY BODY 2
9947020913506



SAVAGE ORC BOAR BOY BODY 3
9947020913507



SAVAGE ORC BOAR BOY BODY 4
9947020913508



SAVAGE ORC BOAR BOY HEAD 3
9947020913503



SAVAGE ORC BOAR BOY HEAD 4
9947020913504

RARE UNITS



Giant Box (1)
99110209127



GIANT BAG
9947020912712



GIANT CHEST
9947020912708



GIANT BACK
9947020912710



GIANT LEFT ARM
9947020912705



GIANT LEFT LEG
9947020912701



GIANT RIGHT LEG
9947020912702



GIANT HEAD W/ CAP & MASK
9947020912707



GIANT BARE HEAD
9947020912711



GIANT RACKED SHEEP
9947020912703



GIANT CAPTIVE HALFLING
9947020912704



GIANT COWERING CIVILIAN
9947020912706



GIANT RIGHT ARM W/ CLUB
9947020912709

RARE UNITS



Stone Troll Blister (Random 1)
99060299007



STONE TROLL BODY W/ ROCK
9947029900707



STONE TROLL HEAD 1
9947029900704



STONE TROLL BODY W/ AXE & BONE CLUB
9947029900709



STONE TROLL BODY W/ TWO-HANDED AXE
9947029900708



STONE TROLL HEAD 2
9947029900705



STONE TROLL HEAD 3
9947029900706



These alternate bits for the Stone Trolls are available only via Special Offer.



STONE TROLL W/ STONE HAMMER
9947029900701



STONE TROLL W/ AXE
9947029900702



STONE TROLL W/ BONE CLUB
9947029900703



RARE UNITS



River Troll Blister (Random 1)
99060299006



RIVER TROLL HEAD 1
9947029900604



RIVER TROLL HEAD 2
9947029900605



RIVER TROLL HEAD 3
9947029900606



RIVER TROLL BODY 1
9947029900601



RIVER TROLL BODY 2
9947029900602



RIVER TROLL BODY 3
9947029900603



RARE UNITS



DOOM DIVER HOOK
9947020910909



DOOM DIVER SNOTLING W/ MALLET
9947020910907



DOOM DIVER GOBLIN DIVER LEGS
9947020910910



Goblin Doom Diver Catapult Box (1)
99110209109



DOOM DIVER CATAPULT
9947020910904



DOOM DIVER SNOTLING PULLERS
9947020910905



DOOM DIVER RAMP
9947020910901



DOOM DIVER RAMP BASE
9947020910903



DOOM DIVER RAMP SUPPORT
9947020910902



DOOM DIVER GOBLIN DIVER TORSO
9947020910908



DOOM DIVER GOBLIN FLYER
9947020910906



RARE UNITS



Snotling Pump Wagon Box (1)
99110209136



PUMP WAGON SCYTHES
9947020913613



PUMP WAGON PUMP
9947020913611



PUMP WAGON SNOTLING PUMPER 1
9947020913605



PUMP WAGON SNOTLING PUMPER 2
9947020913608



PUMP WAGON SNOTLING 1
9947020913601



PUMP WAGON SNOTLING 2
9947020913602



PUMP WAGON SNOTLING 3
9947020913603



PUMP WAGON SNOTLING 4
9947020913604



PUMP WAGON SNOTLING 6
9947020913606



PUMP WAGON SNOTLING 7
9947020913607

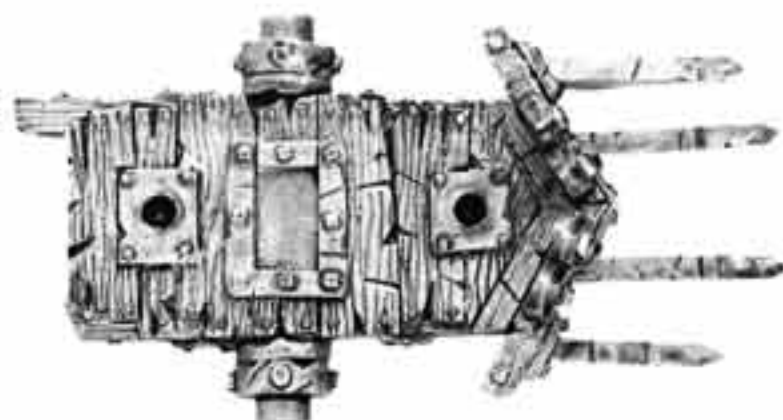

PUMP WAGON BASE
9947020913609

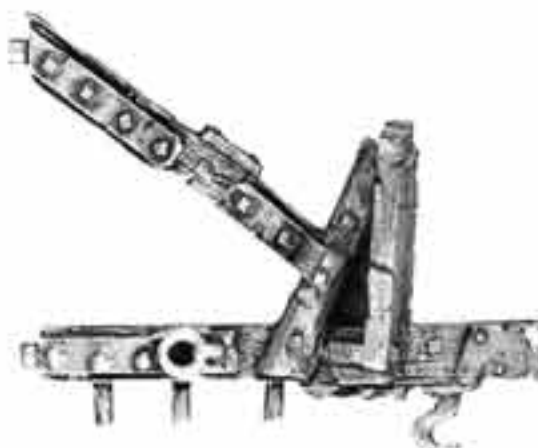

PUMP WAGON MAST
9947020913614



PUMP WAGON WHEEL
9947020913612



PUMP WAGON FAIRING
9947020913610



PUMP WAGON STEERING WHEEL
9947020913615





COLORS OF WAR



KEY

■ Top Box(es): Basecoat Colors & Ink Washes

■ Bottom Box(es): Highlights

■ Mixed Colors



Snot Green, Camo Green
Scorpion Green, Rotting Flesh



Dark Angels Green, Codex Grey
Goblin Green, Fortress Grey



Snot Green, Chaos Black
Goblin Green, Chainmail & Red Ink



Scab Red, Snot Green
Blood Red, Snot Green & Skull White



Dark Angels Green, Bestial Brown
Goblin Green, Bubonic Brown



Dark Angels Green, Kommando Khaki
Goblin Green, Bleached Bone



Ultramarines Blue, Liche Purple
Ice Blue, Liche Purple & Skull White



Graveyard Earth, Bleached Bone
Snakebite Leather, Skull White



Red Gore, Bestial Brown
Blood Red, Bleached Bone



Warlock Purple, Tentacle Pink
Tentacle Pink, Tentacle Pink & Skull White



Chaos Black, Golden Yellow
Skull White, Bad Moon Yellow



Chaos Black, Bleached Bone
Fortress Grey, Scab Red



Red Gore, Dwarf Bronze
Blood Red, Burnished Gold



Scorched Brown, Bleached Bone
Bestial Brown, Skull White



Chaos Black, Boltgun Metal
Scab Red, Chainmail



Scorched Brown, Bleached Bone, Chaos Black
Snakebite Leather, Skull White, Fortress Grey



Chaos Black, Scab Red, Bleached Bone
Fortress Grey, Blood Red, Skull White



Red Gore, Bleached Bone, Boltgun Metal
Blood Red, Skull White, Mithril Silver

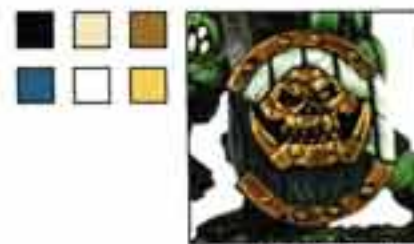

Chaos Black, Bleached Bone, Dwarf Bronze
Shadow Grey, Skull White, Burnished Gold

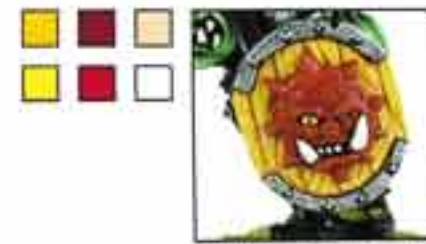

Golden Yellow, Red Gore, Bleached Bone
Bad Moon Yellow, Blood Red, Skull White

TACTICS



TIPS FOR WINNING WITH ORCS & GOBLINS

- A. Large units of Goblins or Night Goblins with full command make excellent helpers for units of Monsters (such as Trolls or Giants), chariots, or cavalry. While the other units provide the hammer-blow hitting power, the Gobbos add outnumbering, ranks, and a banner to the combat resolution which will usually result in a broken enemy unit.
- B. An Orc & Goblin army is not one normally thought of as being magic-heavy. You can spring a nasty surprise on an opponent by bringing an army tooled-out to sling spells of the Big Waaagh! Many spells of the Big Waaagh! are very effective and easy to cast, especially ones such as Foot of Gork. Target expensive, elite units (such as Inner Circle Knights or Chaos Knights) with these spells, and you can wreak severe damage.
- C. The Orc & Goblin army can field very inexpensive war machines in the form of the 35-point Spear Chukkas. It's easy to load up on several of these war machines (another tactic that may surprise many opponents) and use a spell such as Mork Save Uz! to reroll misses from the Spear Chukka's relatively mediocre BS3. A volley of accurate war machine fire can shut down quite a few of the tactics mentioned elsewhere in this catalog.



COUNTERTACTICS

TIPS FOR FIGHTING AGAINST ORCS & GOBLINS

- A. Goblins can form large units for a low points cost, but they also have low Leadership. Flying units can stop these units from marching, while any *Terror*-causing units are likely to send these little fellows heading for the hills at the first opportunity.
- B. The strategy for stopping a magic-focused army from ruling the battlefield is similar no matter the caster. Judicious use of Dispel Dice and Dispel Scrolls will keep your Knights riding towards the enemy, and if you can target the Shamans, let 'em have it! Orc & Goblin Shamans are not nearly as difficult to kill as the other Lords and Heroes in this army.
- C. Spear Chukkas may be inexpensive, but part of that low points cost is represented in the weak combat ability of their crews. Any Flying unit can handle Spear Chukkas just by tearing into the Gobbo crew, and shooting or magic missiles can be equally effective.

SHOW CASE



Right: Jarrett Lee's "Troll Battering" won second place at the 2004 Los Angeles Games Day Golden Demon Painting Competition.

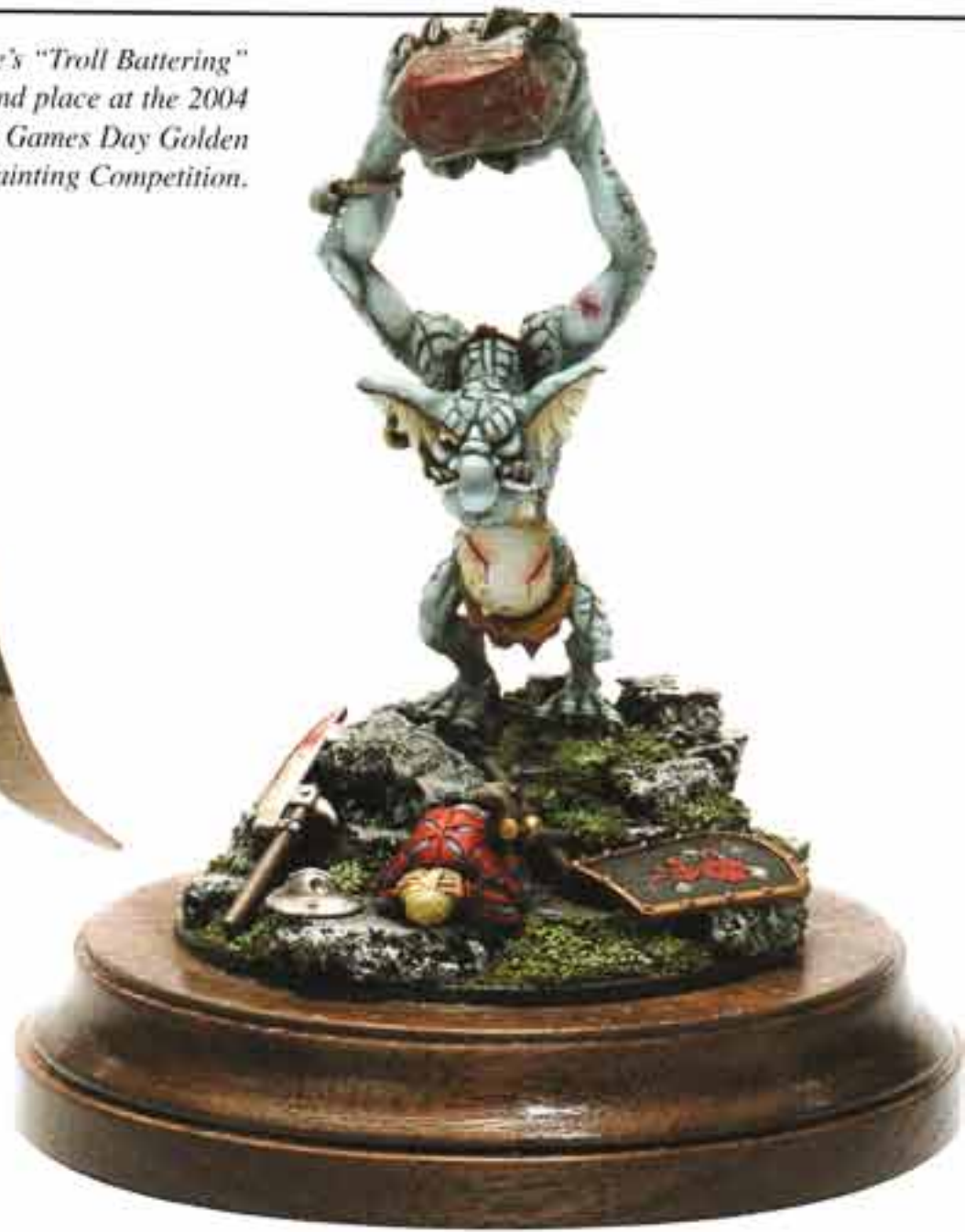

Left: Angela Imrie tied for third place at the 2004 Los Angeles Games Day Golden Demon Painting Competition.



Right: This Gringor Ironhide won David Garcia a place at Spain's Games Day Golden Demon painting competition.

ALTERNATE MODEL – CORE

Goblins

COMPONENTS FOR 4 COMPLETE MODELS

- 99380209001 Night Goblin Sprue
- 9947020801817 Terradon Rider Shield
- 9947040301201 Grot 1
- 9947040301203 Grot 3
- 9947040302803 Grot w/ Slugga & Knife
- 9947040302804 Grot w/ Two Shootas

COMPLEXITY RATING



THIS CONVERSION CONTAINS THE SPECIAL OFFER BITZ SHOWN HERE

See the catalog introduction for more information.



TERRADON RIDER SHIELD
9947020801817





SHOWCASE

Below: Tracz Jakub shows amazing detail on each of these Stone Trolls and won first place in the Warhammer Regiment category at the 2001 Games Day Golden Demon painting competition.



Left: Francisco Javier Martinez Linares won at the Golden Demon Painting Competition at Spain's 2001 Games Day with the Goblin Shaman on the Dwarf Shield.

Right: Tim Lison won the Slayer Sword at the 2003 Chicago Games Day Golden Painting competition with Skarsnik, Warlord of Karak Eight Peaks.



Above: Nick Cristofoli's Giant from the 2004 Storm of Chaos Campaign.

ALTERNATE MODEL - CORE

Big'Uns

COMPONENTS FOR 4 COMPLETE MODELS

- 99380209002 Orc Regiment Sprue
- 99360299004 Orc Shield Sprue
- 9947010308505 Ork 'Ard Boyz Shoulder Sp.
- 9947010308505 Ork 'Ard Boyz Jaw Sprue

COMPLEXITY RATING



THIS CONVERSION CONTAINS THE SPECIAL OFFER BITZ SHOWN HERE

See the catalog introduction for more information.



ORK 'ARD BOYZ JAW SPRUE
9947010308505



ORK 'ARD BOYZ SHOULDER SPRUE
9947010308506

SKAVEN

The Gutter Runners had taken out all the Dwarf artillery, and the main Clanrats had advanced unopposed. In short order, the remaining units were gathered from their bone-gnawing and reorganized to give chase to the retreating Dwarf-things.

"Oh honored of Leaders, allow Stormvermin to lead the kill. Yes, Yes?" pestered the Fangleader of the Stormvermin, vying to steal the glory of the final assault.

But Snekt was no novice at fighting the Dwarf-things underground. Chasing Dwarf-things into their lair was always deadly. It would serve the ambitious Fangleader right to turn the corner and meet a unit of the thickly armored Dwarf-things. But no, thought Snekt, I'll need Stormvermin later.

"No, No, not Stormvermin. Bring up Pawleader Chitter and his pack." demanded the Chieftain. Bristling with honor, Pawleader Chitter brought up his unit of Skaven Slaves to lead the advance further into the Dwarf stronghold. Snekt's tail twitched at his own cleverness.

Skaven are a race of evil ratmen who have gnawed a series of tunnels and an entire underkingdom beneath the surface of the Warhammer world. Occasionally erupting forth in a seething horde, the Skaven seek nothing less than world domination.

Fighting Style

Skaven armies can muster a variety of deadly threats and different troop types. Two cornerstones of Skaven warfare are the massed attack and dirty underhanded tricks. The massed attack part is easy. Great masses of Clanrats and Skaven Slaves are affordable and can anchor the center of a vermin attack. Occasionally, these troops will win a battle, but more often than not, they will serve to tie up the foe and to pin him in place. Clanrats may be accompanied by Weapon Teams wielding ingenious devices of the Skaven that can be used to thin down the foe. While enemy units are pinned by large blocks of Clanrats, additional units may attack the foe in the sides.

Skaven have no concept of valor, and a stab in the back is every bit as good as an up-front challenge – in fact, it's probably a lot better. *Poisoned Attacks*, sneaky infiltrators, and hidden Assassins are all part of the Skaven arsenal. Even better, Skaven armies are allowed to fire into combat with their special *Life Is Cheap* rule. This tactic works fantastically well with large units of Skaven Slaves and Clanrats, as they will tie up the foe while Poisoned Wind Globadiers and Weapons Teams pour fire into the combat. The vermin hordes can well afford to fight a battle of attrition, and as the Poisoned Wind Globes ignore armor saves, they are sometimes the best way to rid yourself of the foe's best troops. Nothing wounds a Knight's pride like being lured into a trap where skill at arms and fighting mean little!

Collecting a Skaven Army

All armies are required to field a minimum number of Core units, and so it makes sense to begin a new army with Core choices. For

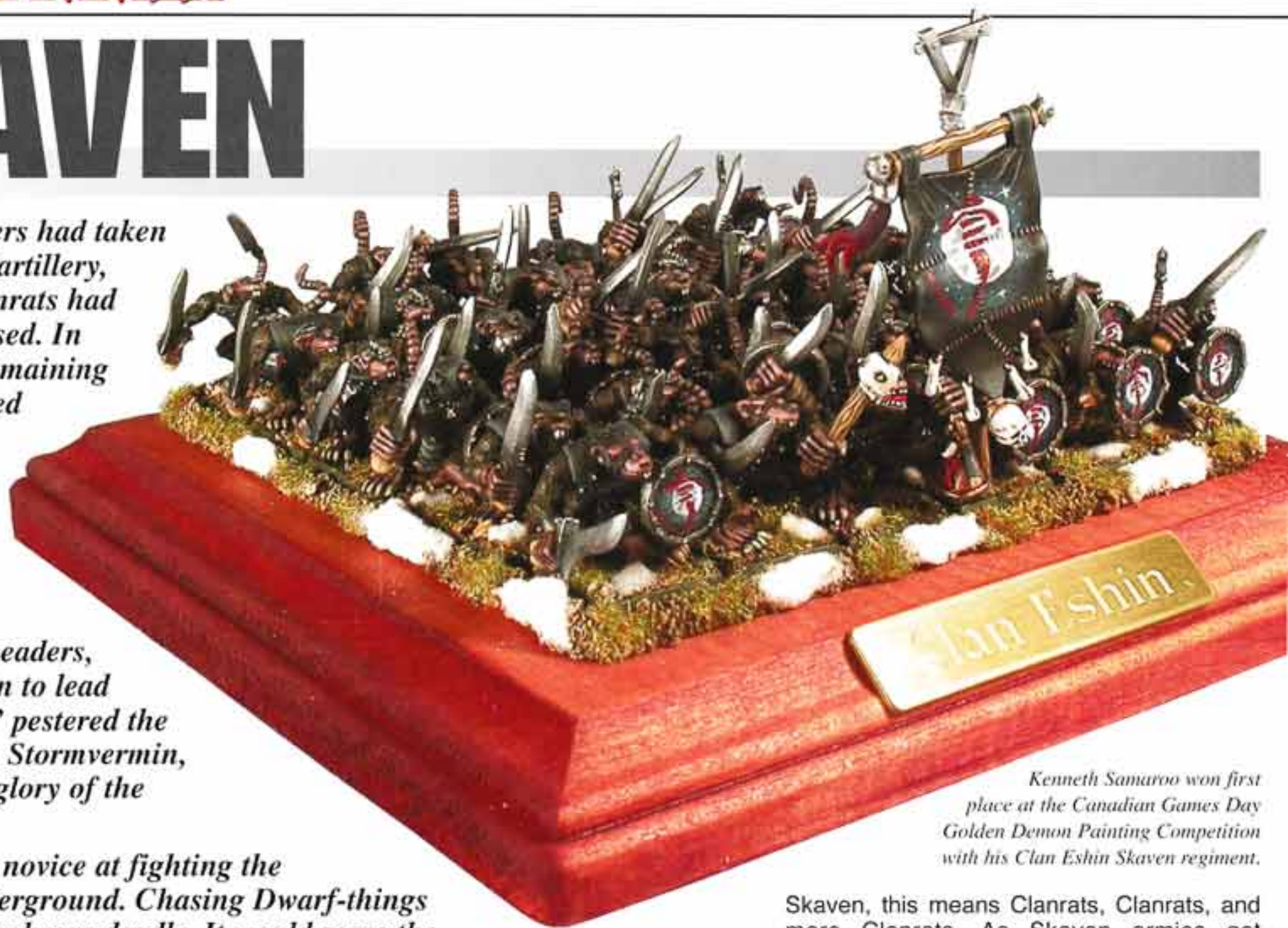

Kenneth Samaroo won first place at the Canadian Games Day Golden Demon Painting Competition with his Clan Eshin Skaven regiment.

Skaven, this means Clanrats, Clanrats, and more Clanrats. As Skaven armies get Leadership bonuses for large units, it makes sense to field a few larger units with deep ranks. Additional Core choices (although they may never outnumber the Clanrats) are Giant Rats, Night Runners, Skaven Slaves, and Poisoned Wind Globadiers. Stormvermin have better Weapon Skill and equipment and can make for a nasty surprise for an enemy expecting only Clanrats.

Skaven players also have many options for filling out the edges of their hordes. Gutter Runners are elite Scouts that may tunnel or infiltrate onto the battlefield for sneak attacks. Warplock Jezzails and the dreaded Warp-Lightning Cannon are long-ranged weapons that can rain death on the foe as the bulk of the Skaven army skitters closer. Rat Ogres can form shock attack units capable of delivering quite a blow, and Plague Monks, with their Toughness and *Frenzy*, can make a formidable unit as well. Plague Censer Bearers may accompany Plague Monks, and their poisoned censers create a deadly cloud of warpstone vapors that can slay a foe before combat even begins.

Skaven Characters can bolster units, and specialty Heroes like a Master Moulder, Warlock Engineer, or Assassin can turn an important fight the vermin way. The most powerful character a Skaven can field is a Grey Seer, a warpstone-crazed sorcerer of mighty powers that can ride to battle atop the wicked contraption known as a Screaming Bell.



Skaven Battalion Box 99120206003

- 40 Clanrats
- 2 Rat Ogres
- 6 Giant Rats & 2 Packmasters
- 20 Plague Monks



GETTING STARTED

The 80-page Warhammer Armies: Skaven contains all the rules for gathering a Skaven horde to your banner and including the four greater clans of the Horned Rat. There are also a new Skaven spell list, devastating Skaven war machines, and infamous special characters such as Throt the Unclean.

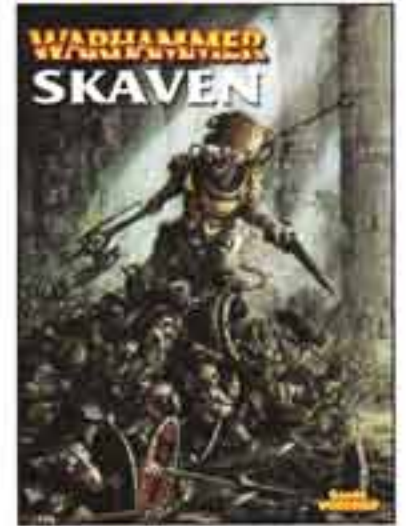

Warhammer Armies: Skaven
60030206001



LORDS & HEROES



GREY SEER 1



GREY SEER 2
9947020606903

Skaven Grey Seer Blister (Random 1)
99060206069



GREY SEER 1 BODY
9947020606901



GREY SEER 1 HEAD
9947020606902



SKAVEN ASSASSIN 1
9947020606601



Skaven Warlord Blister (1)
99060206056



WARLORD BODY
9947020605601



WARLORD BANNER TOP
9947020605604



SKAVEN ASSASSIN 2
9947020606602



WARLORD WEAPON
9947020605602



WARLORD TAIL & BANNER POLE
9947020605603

Skaven Assassin Blister (Random 1)
99060206066



LORDS & HEROES



BONERIPPER



GREY SEER THANQUOL
9947020601701



Grey Seer Thanquol & Boneripper Box (2)
99110206055



BONERIPPER HEAD
9947020605501



BONERIPPER CLAW ARM
9947020605504



BONERIPPER GUN ARM
9947020605502



BONERIPPER BODY
9947020605503



BONERIPPER LEGS
9947020605505



Plague Lord Nurglitch Box (1)
99110206076



NURGLITCH BODY
9947020607601



NURGLITCH CENSER BEARER
9947020607603



NURGLITCH BANNER
9947020607602

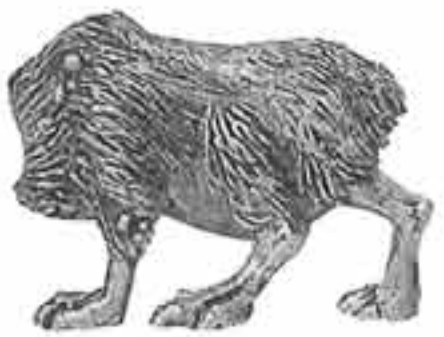

NURGLITCH RAT LEFT SIDE
9947020607606



NURGLITCH RAT RIGHT SIDE
9947020607607



NURGLITCH SPRUE 1
9947020607604



NURGLITCH SPRUE 2
9947020607605



LORDS & HEROES



Skaven Screaming Bell Box (1)
99110206059



SCREAMING BELL GREY SEER
9947020605909



SCREAMING BELL HALF
9947020605904



SCREAMING BELL TOP
9947020605902



SCREAMING BELL STRIKER
9947020605910



SCREAMING BELL BASE
9947020605907



SCREAMING BELL HOLDER
9947020605903



SCREAMING BELL LEFT SUPPORT
9947020605905



SCREAMING BELL RIGHT SUPPORT
9947020605901



SCREAMING BELL RIGHT WHEELS
9947020605906



SCREAMING BELL LEFT WHEELS
9947020605908



LORDS & HEROES



Throt the Unclean One Blister (1)
99060206068



THROT BODY
9947020606801



THROT STAFF
9947020606802



Clan Pestilens Plague Lord Blister (1)
99060206074
BIT NAME: PLAGUE LORD 1
BIT CODE: 9947020607401



THROT SWORD
9947020606803



THROT WHIP
9947020606804



Skaven Warlock Blister (Random 1)
99060206062



WARLOCK ENGINEER BODY 1
9947020606201



WARLOCK ENGINEER BODY 2
9947020606202



WARLOCK ENGINEER ARM 1
9947020606203



WARLOCK ENGINEER ARM 2
9947020606204



WARLOCK BACKPACK 1
9947020606205



WARLOCK BACKPACK 2
9947020606206

CORE UNITS



Skaven Clanrat Regiment Box (20)
99120206001

The Skaven plastics can be armed with hand weapons or spears and can be fielded as Clanrats or as Skaven Slaves.

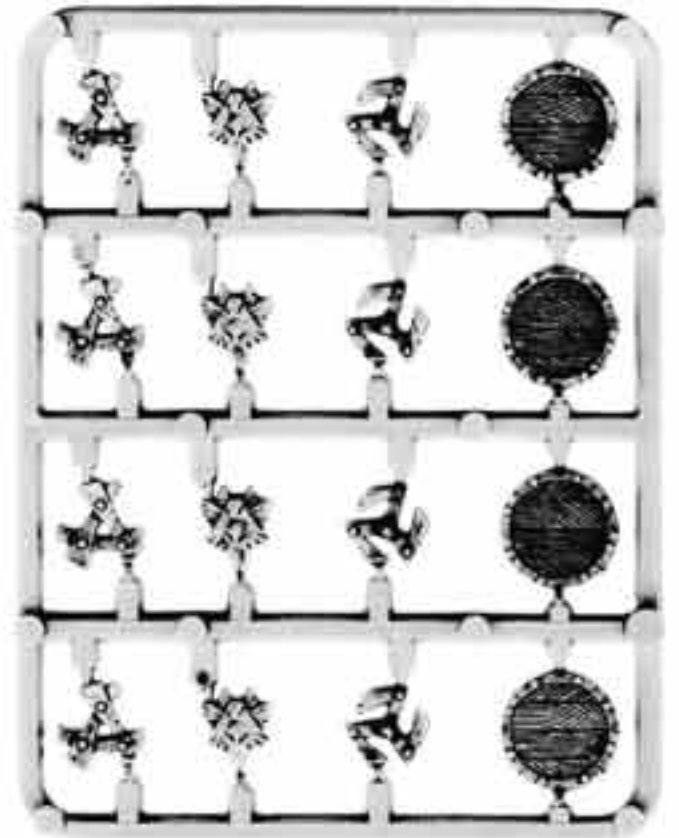

SKAVEN CLANRAT SHIELD SPRUE
(SHOWN 85% ACTUAL SIZE)
99360299006

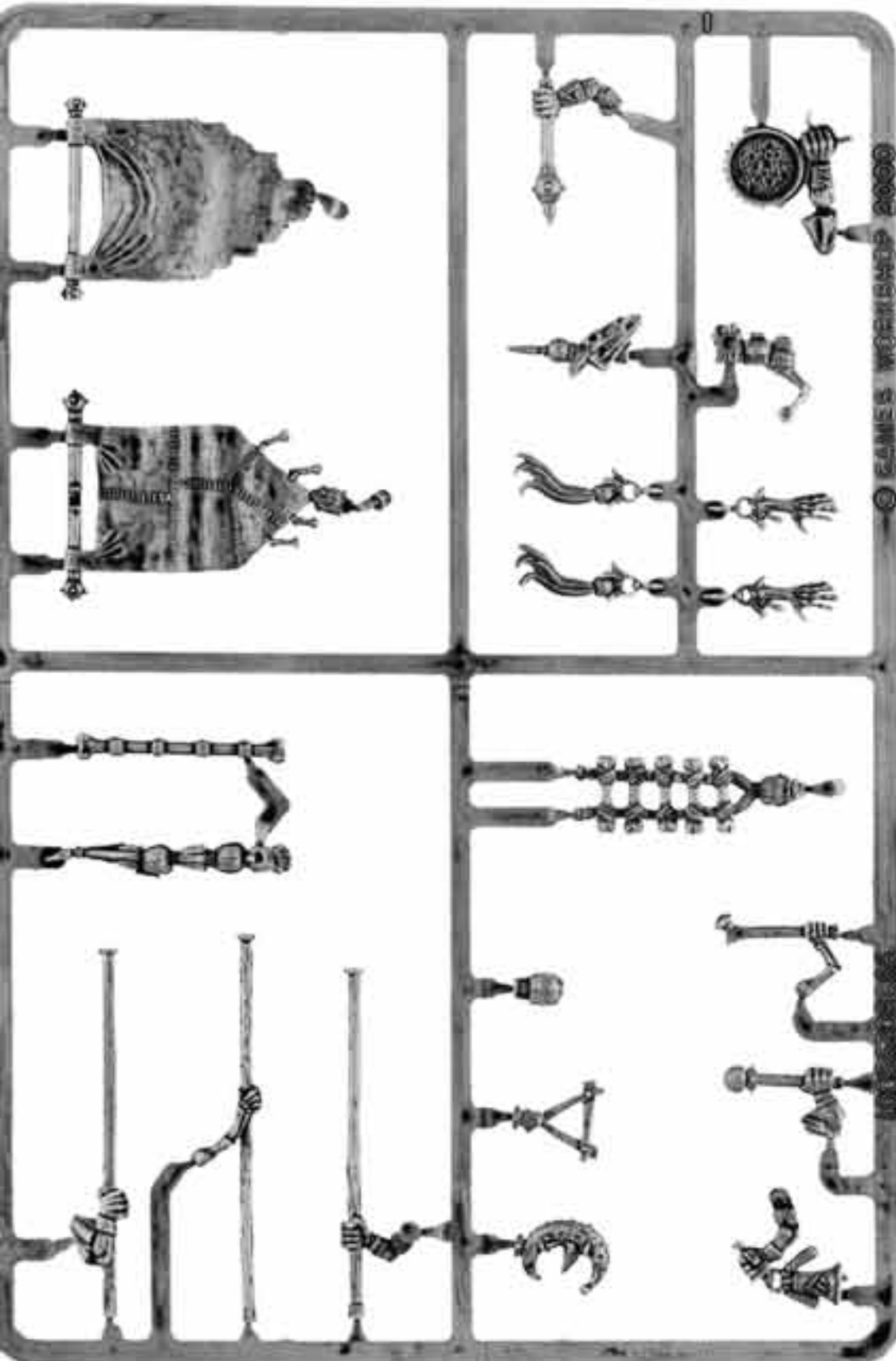

REGIMENT COMMAND SPRUE (SHOWN AT 70% ACTUAL SIZE)
99380299001

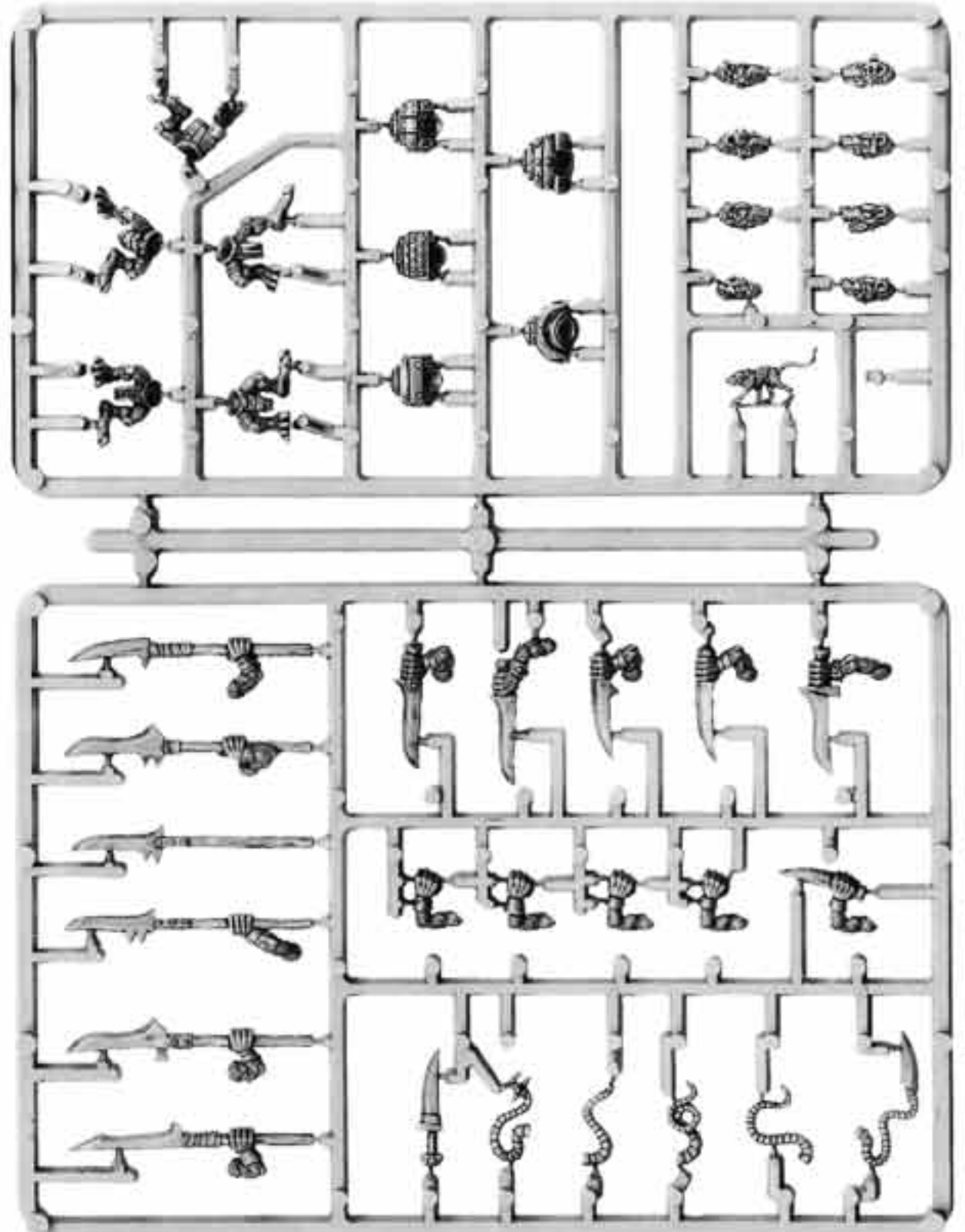

SKAVEN REGIMENT CLANRATS SPRUE (SHOWN 60% ACTUAL SIZE)
99380206001

All miniature are supplied unpainted. Models, kits, and sprues are all shown as they will appear unless otherwise noted. Contents may vary slightly from those shown.

CORE UNITS



Skaven Night Runners
Regiment Box (20)
99120206002

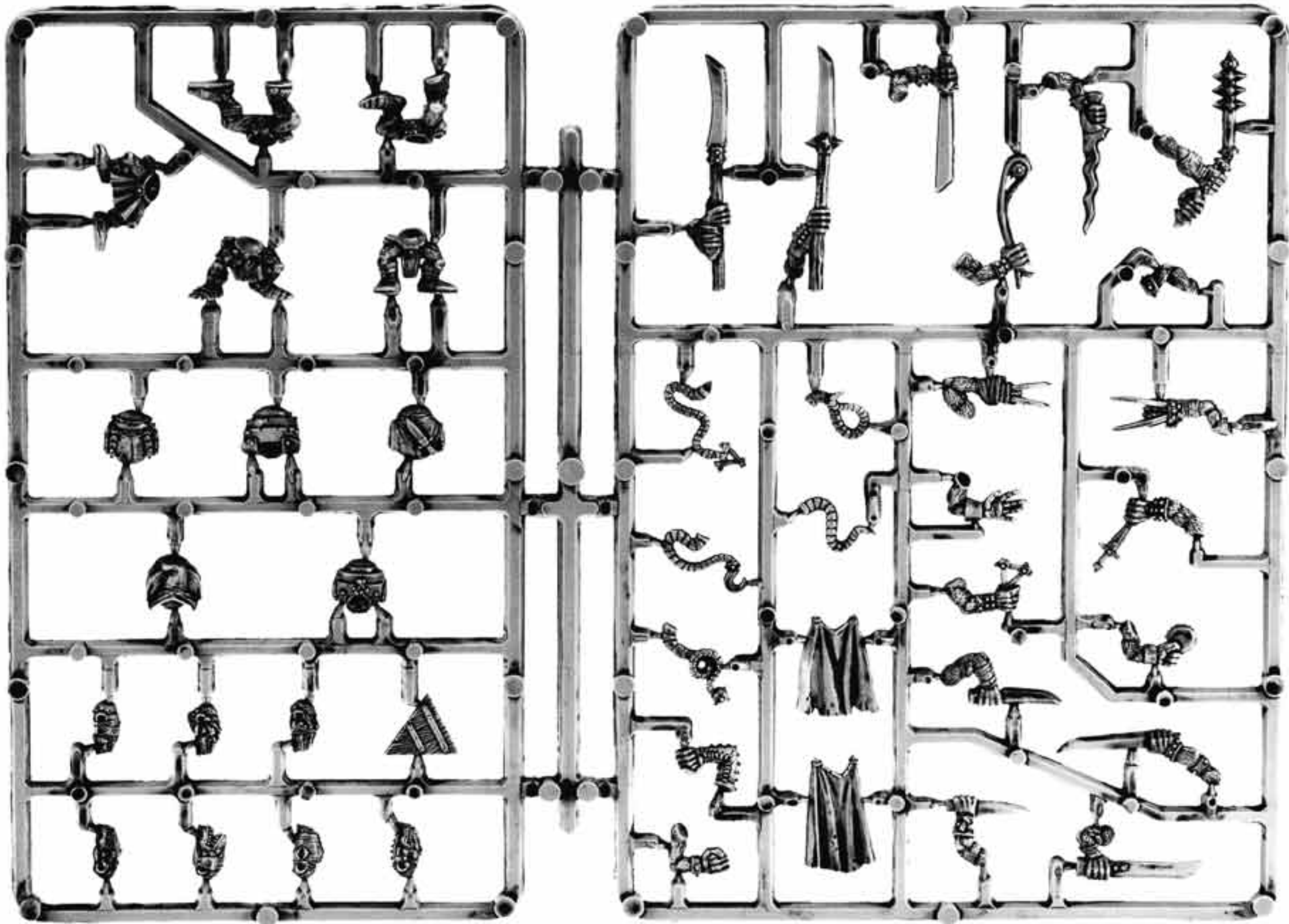

SKAVEN NIGHT RUNNER SPRUE (SHOWN AT 90% ACTUAL SIZE)
99381106001



Ratling Gun Team Blister (Random 1)
99060206058



RATLING GUN GUNNER 1
9947020605801



RATLING GUN GUNNER 2
9947020605802



RATLING GUN LOADER 1
9947020605803



RATLING GUN LOADER 2
9947020605804



Skaven Rat Swarm Blister (2 Bases)
99060206072



SKAVEN RAT SWARM 1
9947020606501



SKAVEN RAT SWARM 2
9947020606502



CORE UNITS

PAINTING A CLANRAT FAST

The Skaven army is a horde, and the minimum unit size of Core regiments is 20. Here, we take a look at how to paint a Clanrat for your Skaven army quickly. Don't worry about being too neat as you work. Concentrate on cranking out numbers. Once you put all your models in units, you'll find that you have an impressive horde of Skaven.

STEP 1

After spraying the model with black primer, drybrush the fur with Vermin Brown.



STEP 2

Paint all metal areas with Boltgun Metal, cloth areas with Catachan Green, straps and leggings with Snakebite Leather, and the face, tail, and hands with Dwarf Flesh.



STEP 3

Apply a wash of Flesh Wash over the entire model except for the fur areas.



STEP 4

Highlight the edges of all areas painted with the original colors used in Step 2. Finish the base of the model with sand or flock to match the rest of your horde.





CORE UNITS

PAINTING WARPSTONE

A lot of models in the Skaven army feature warpstone, magical crystalline stones that radiate corrupting magical energy. Because warpstone is prominent on so many Skaven models, it's worth paying a bit of attention to these areas. Below, we outline a simple but effective method for painting warpstone.



STEP 1

Start with a basecoat of Dark Angels Green.

STEP 2

Highlight with Snot Green.

STEP 3

Paint Scorpion Green in patches as the final highlight.

STEP 4

To create a glassy effect, paint some Gloss Varnish on the areas of warpstone as a final step.



Warpfire Throwing Team Blister (Random 1)
99060206013



**WARPFIRE THROWER
FUEL CARRIER 1**
9947020601305



**WARPFIRE THROWER
GUNNER 1**
9947020601301



**WARPFIRE THROWER
GUNNER 2**
9947020601303



**WARPFIRE THROWER
FUEL CARRIER 2**
9947020601306



**Skaven Poisoned Wind
Globadier Blister (Random 1)**
99060206007



GLOBADIER BACKPACK 1
9947020600704



GLOBADIER BACKPACK 2
9947020600706



GLOBADIER 1
9947020600702



GLOBADIER 2
9947020600703



GLOBADIER 3
9947020600705



CORE UNITS



Skaven Stormvermin Box (10) & Skaven Stormvermin Command Blister (3)
 99110206061 99060206060



STORMVERMIN 1
9947020606101



STORMVERMIN 2
9947020606102



STORMVERMIN
CHAMPION BODY
9947020606001



STORMVERMIN
CHAMPION ARM
9947020606004



STORMVERMIN
DRUMMER ARM
9947020606006



STORMVERMIN 3
9947020606103



STORMVERMIN 4
9947020606104



STORMVERMIN
STANDARD BEARER
9947020606002



STORMVERMIN
STANDARD
9947020606005



STORMVERMIN
HALBERD 1
9947020606105



STORMVERMIN
HALBERD 2
9947020606106



STORMVERMIN
HALBERD 3
9947020606107



STORMVERMIN
HALBERD 4
9947020606108



STORMVERMIN
MUSICIAN
9947020606003

SPECIAL UNITS



Rat Ogres & Giant Rats Box (16)
99120206005

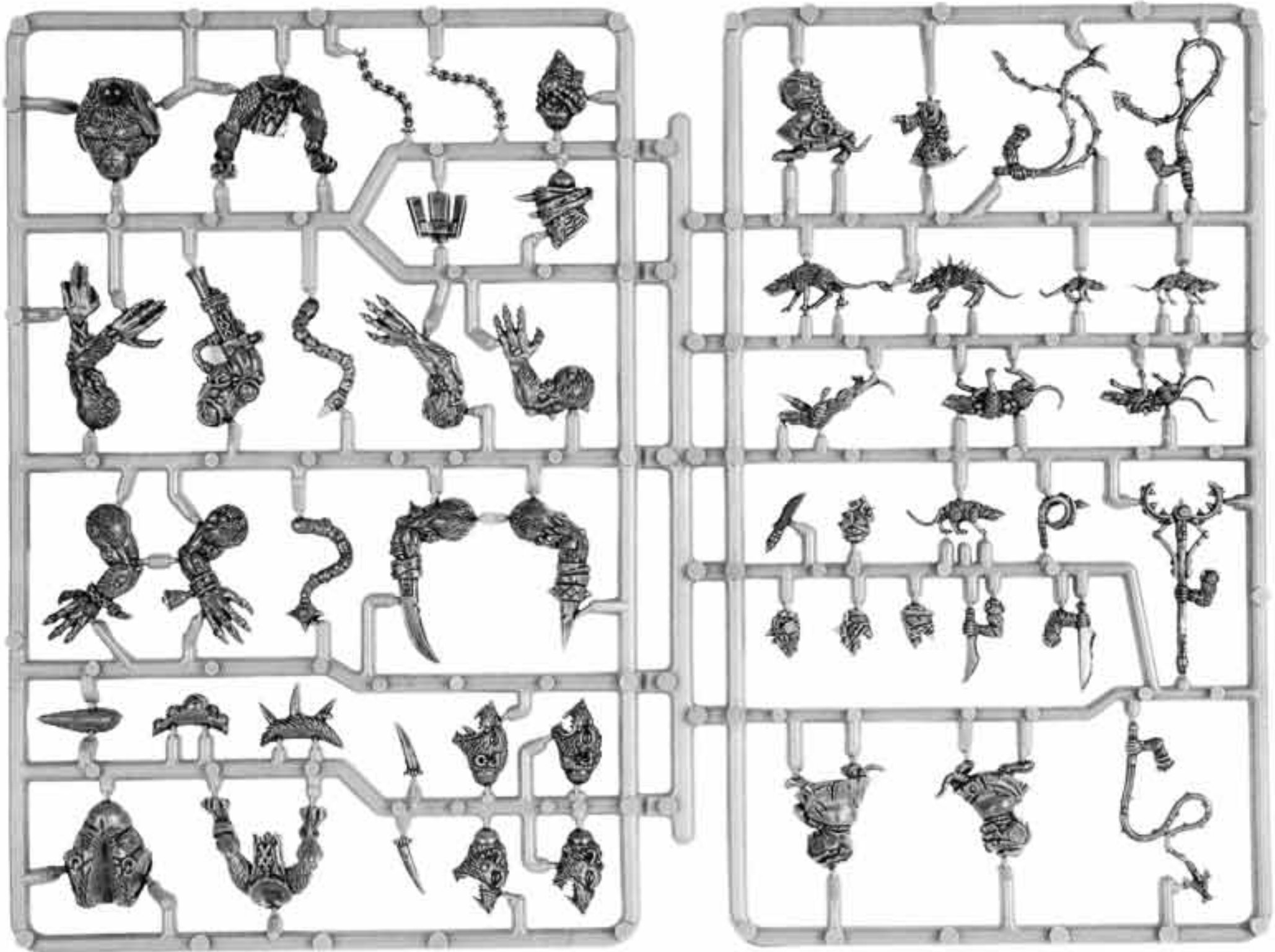

RAT OGRE & GIANT RATS SPRUE (SHOWN 60% ACTUAL SIZE)
AVAILABLE ONLY IN BOX



SPECIAL UNITS



Plague Monks Box (16)
99120206004

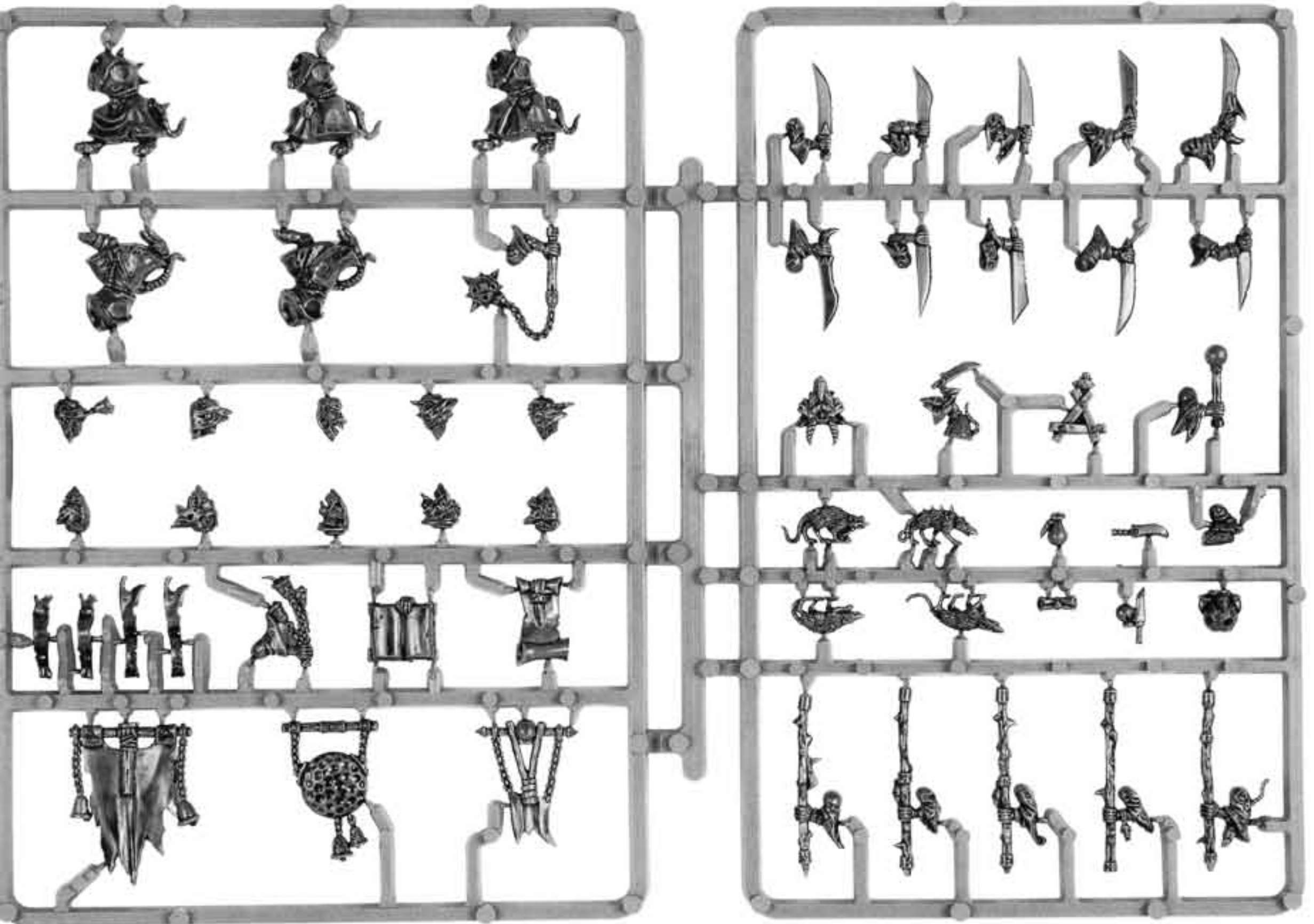

PLAGUE MONKS SPRUE (SHOWN 70% ACTUAL SIZE)
99380206002



SPECIAL UNITS



GUTTER RUNNER 1
9947020606701



GUTTER RUNNER 2
9947020606702



GUTTER RUNNER 3
9947020606703



GUTTER RUNNER 4
9947020606704



Skaven Gutter Runners Blister (Random 3)
99060206067



Warplock Jezzail Team Blister (Random 1)
99060206064



JEZZAIL SHIELD BEARER 1
9947020606403



JEZZAIL GUNNER 2
9947020606402



JEZZAIL SHIELD BEARER 2
9947020606404



JEZZAIL GUNNER 1
9947020606401



JEZZAIL SHIELD 1
9947020606405



JEZZAIL SHIELD 2
9947020606406



JEZZAIL SHIELD 3
9947020606407

RARE UNITS



PLAGUE CENSER BEARER 1
9947020607501



PLAGUE CENSER BEARER 2
9947020607502



PLAGUE CENSER BEARER 3
9947020607503



PLAGUE CENSER BEARER 4
9947020607504

Plague Censer Bearers Blister (1)
99060206075

RARE UNITS



Skaven Warp-Lightning Cannon Box (1)
99110206054



LIGHTNING CANNON GUNNER
9947020605406



LIGHTNING CANNON CREWMAN 1
9947020605408



LIGHTNING CANNON CREWMAN 2
9947020605409



LIGHTNING CANNON GUNNER ARM
9947020605407

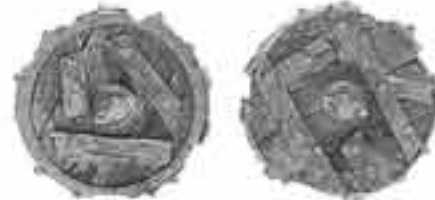

LIGHTNING CANNON WHEELS
9947020605405



LIGHTNING CANNON SIGHT
9947020605401

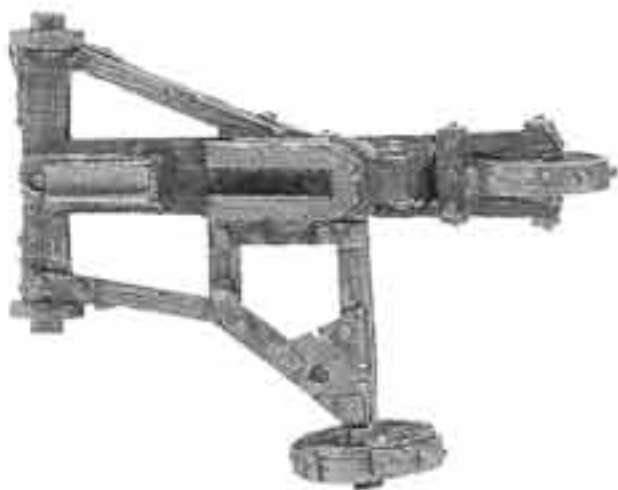

LIGHTNING CANNON BASE
9947020605404



LIGHTNING CANNON BARREL FRONT
9947020605402



LIGHTNING CANNON BARREL BACK
9947020605403

PAINTING CLAN ESHIN

Here are some simple techniques to give your Skaven that pestilent look.

STEP 1. Undercoat the entire regiment with Chaos Black. Paint the robes with a mix of equal parts of Bleached Bone and Skull White. Make sure to leave the undercoat showing in the folds of cloth.



STEP 2. Mix Brown Ink with Chaos Black paint, white glue, and water. Apply the ink wash onto the robes. Using your thumb, remove any excess ink. While the miniature is still wet, take a small brush and dab spots of Green Ink onto the cloak.

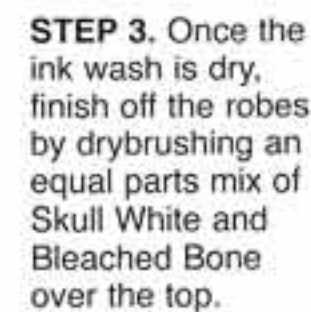

STEP 3. Once the ink wash is dry, finish off the robes by drybrushing an equal parts mix of Skull White and Bleached Bone over the top.

STEP 4. With the robes painted, you can pick out the other parts of the model. Use Tin Bitz for the weapons, Bronzed Flesh mixed with Bleached Bone for the flesh and tails, Vermin Brown for the fur, Camo Green on the banner and scrolls, Bleached Bone for the teeth and pustules, and Scorched Brown for the staff.



STEP 5. Mix Chestnut Ink, Scorched Brown, white glue, and water together and apply it to the weapons, flesh, staffs, belts, and parchment. Paint Red Ink onto the pustules to make them stand out.

STEP 6. To finish the unit, you just need to add some final touches. Drybrush the weapons with Chainmail. Use Brazen Brass over the bells and armor. Apply a Camo Green highlight to the banner and scrolls. Use a mix of Terracotta and Scorched Brown on the raised areas of the staff. Paint the skin with a mix of Bronzed Flesh and Bleached Bone. Highlight the teeth and nails with Bleached Bone.





COLORS OF WAR



KEY

■ Top Box(es): Basecoat Colors & Ink Washes

■ Bottom Box(es): Highlights

■ Mixed Colors



*Dark Flesh, Scorched Brown, Snakebite Leather
Bronzed Flesh, Snakebite Leather, Bubonic Brown*



*Tanned Flesh, Scorched Brown, Chainmail
Elf Flesh, Bubonic Brown, Ice Blue & Mithril Silver*

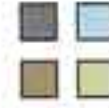

GREY SEER
*Codex Grey, Space Wolves Grey
Kommando Khaki, Rotting Flesh*



PLAGUE LORD
*Scaly Green, Bestial Brown
Bubonic Brown, Desert Yellow*



*Tanned Flesh, Scorched Brown, Flesh Wash
Snot Green, Goblin Green, Chainmail*

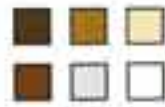

*Scorched Brown, Dwarf Bronze, Bleached Bone
Bestial Brown, Mithril Silver, Skull White*



GUTTER RUNNER
*Chaos Black, Catachan Green
Shadow Grey, Rotting Flesh*

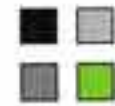

SKAVEN ASSASSIN
*Chaos Black, Chainmail
Codex Grey, Scorpion Green*



*Vermin Brown, Scorched Brown, Dark Angels Green
Dwarf Flesh, Bestial Brown, Goblin Green*



*Terracotta, Bestial Brown, Scab Red
Tanned Flesh, Bubonic Brown, Blood Red*

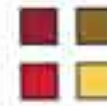

GLOBADIER
*Red Gore, Brazen Brass
Blood Red, Burnished Gold*



PLAGUE CENSER BEARER
*Tanned Flesh, Snot Green
Dwarf Flesh, Snot Green & Bleached Bone*

TACTICS



TIPS FOR WINNING WITH SKAVEN

- A Clan Skryre Skaven army can produce a staggering number of ranged weapon attacks with Jezzail Teams, Ratling Guns, and the Warp-Lightning Cannon (and they can even shoot into combat!). This kind of army can be very difficult to beat, since you can train a devastating salvo of shots into nearly any unit you want, and armor is very little protection.
- Poisoned Wind Globadiers can Wound opponents on a 4+ regardless of Toughness. Aim this unit at tough targets like Monsters, characters, chariots, and war machines.
- Gutter Runners are good *Scouts*. However, when they are upgraded to a Tunneling Team, they can make short work of war machines or lone characters and also can wreak havoc where your opponent least expects it!

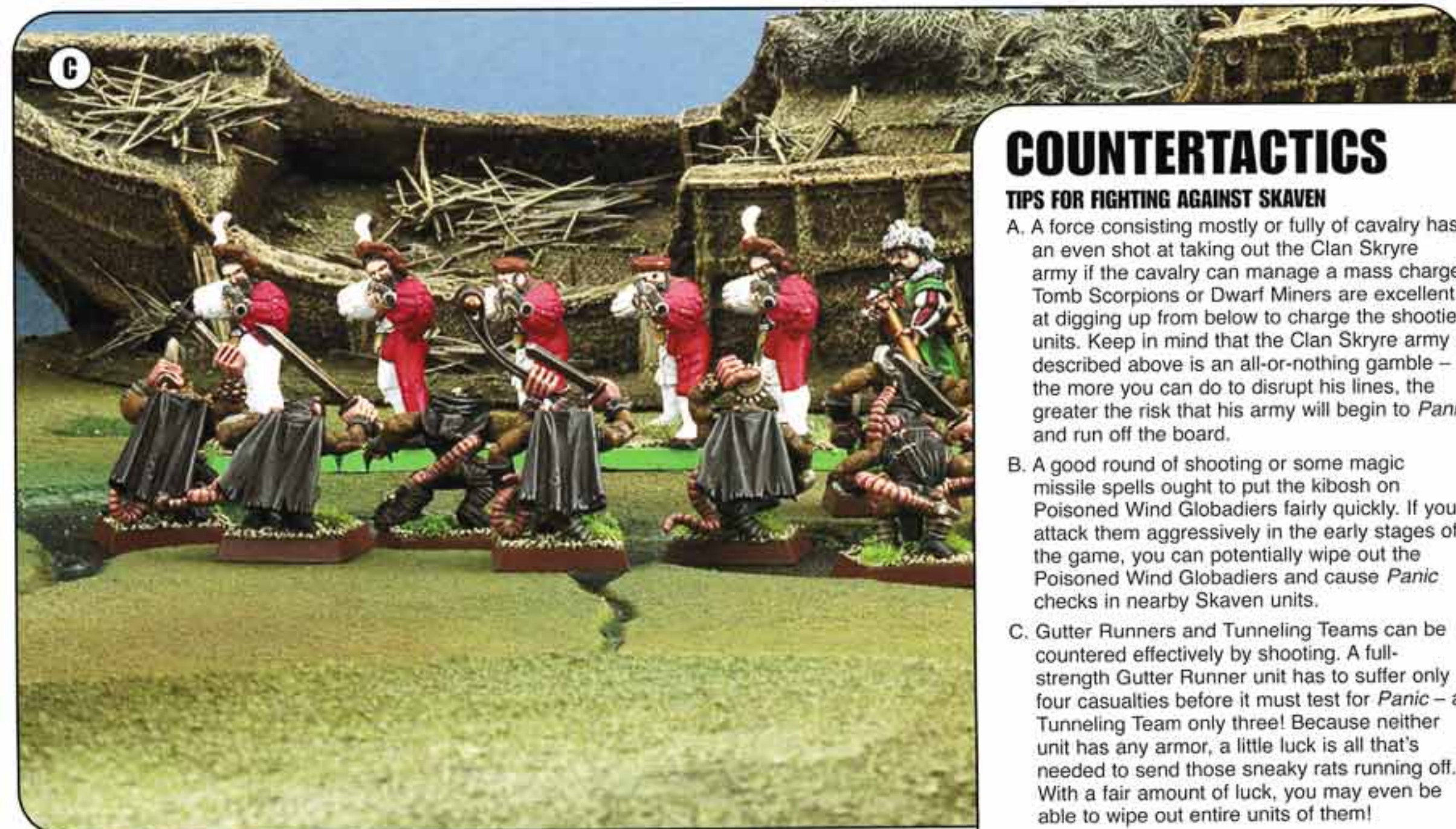

COUNTERTACTICS

TIPS FOR FIGHTING AGAINST SKAVEN

- A force consisting mostly or fully of cavalry has an even shot at taking out the Clan Skryre army if the cavalry can manage a mass charge. Tomb Scorpions or Dwarf Miners are excellent at digging up from below to charge the shooter units. Keep in mind that the Clan Skryre army described above is an all-or-nothing gamble – the more you can do to disrupt his lines, the greater the risk that his army will begin to *Panic* and run off the board.
- A good round of shooting or some magic missile spells ought to put the kibosh on Poisoned Wind Globadiers fairly quickly. If you attack them aggressively in the early stages of the game, you can potentially wipe out the Poisoned Wind Globadiers and cause *Panic* checks in nearby Skaven units.
- Gutter Runners and Tunneling Teams can be countered effectively by shooting. A full-strength Gutter Runner unit has to suffer only four casualties before it must test for *Panic* – a Tunneling Team only three! Because neither unit has any armor, a little luck is all that's needed to send those sneaky rats running off. With a fair amount of luck, you may even be able to wipe out entire units of them!

SHOWCASE

Below: This Rat Ogre by Joe Hill won a bronze trophy in Golden Demon 2000 in the Best Warhammer Monster category.



Below: Timothy Lira won second place at the 2004 LA Golden Demon Painting Competition.



Right: Gotrek vs. Boneripper. Tracz Jakub entered this stunning model into the Baltimore Golden Demon 2002.



Above: Bas van der Schaaf's Gutter Runner vs Pistoler won third place at the 2004 UK Golden Demon Competition.



Right: Matt York's stunning Skaven army won Best Overall at the 2003 Baltimore GT.



ALTERNATE MODEL – CORE

Skaven Slaves

COMPONENTS FOR 4 COMPLETE MODELS

- 99360299006 Skaven Shield Sprue
- 99380207002 Zombie Sprue
- 99381102001 Empire Militia Sprue

COMPLEXITY RATING



SHOWCASE

Above: Jeremy Lehrman's Skaven Poisoned Wind Globadiers won third place at the 2004 Chicago Games Day Golden Demon Painting Competition.

ALTERNATE MODEL – SPECIAL

Rat Ogres

COMPONENTS FOR 2 COMPLETE MODELS

- 99380213005 Ogre Bull Sprue
- 9947010307708 Ork Dreadnought Saw
- 9947010308209 Ork Nob Claw Bottom
- 9947010308210 Ork Nob Power Claw Arm
- 9947020600106 Vermin Lord Tail (x2)
- 9947020605405 Warp Cannon Wheels
- 9947020606304 Rat Ogre Head 1
- 9947020606306 Rat Ogre Head 3
- 9947020606308 Rat Ogre Arm 2
- 9947020606309 Rat Ogre Arm 3
- 9947020606407 Jezzail Shield 3
- 9947991500105 Chaos Spawn Feet (x2)

COMPLEXITY RATING



THIS CONVERSION CONTAINS THE SPECIAL OFFER BITZ SHOWN HERE
See the catalog introduction for more information.



VERMIN LORD TAIL
9947020600106

TOMB KINGS

When the Bretonnian merchant caravan first spotted the dust cloud of travelers out in the open desert, there was much speculation. The exciting prospect of meeting fellow merchants along these desolate trade routes slowly evolved to worrisome rumors. The native guides had spread stories of long buried evils and an ancient power that remained in these desert lands. Gradually, everyone in the party realized that the dust cloud would intersect the course of the caravan.

As the oncoming dust cloud closed the distance and crested the last sand dune, the ghastly nature of the approaching caravan was revealed. Columns of skeletal remains of warriors from some ancient civilization were marching upon the caravan. High overhead, the hungry desert vultures began circling lower and lower, anticipating the feast.

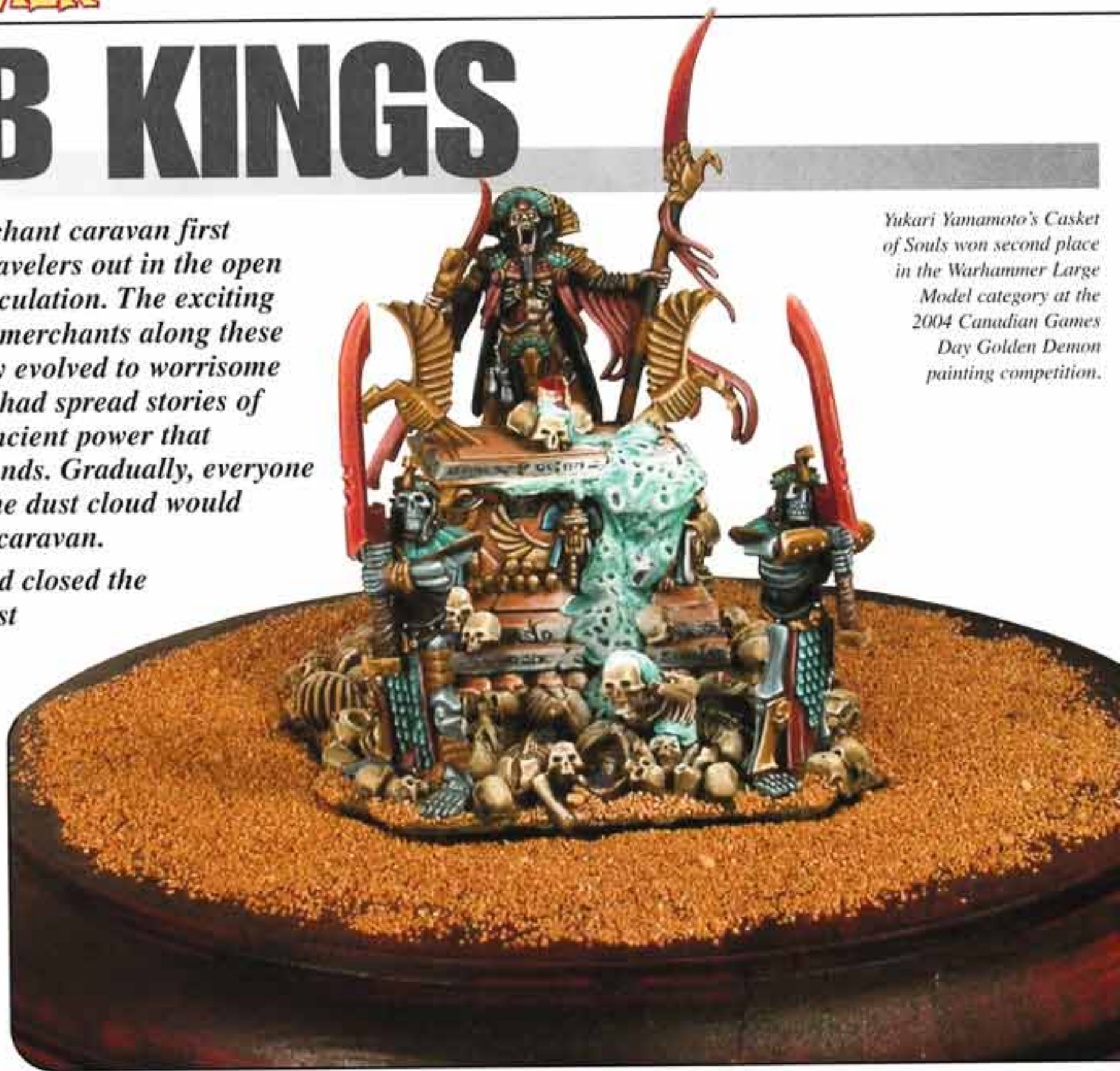

Yukari Yamamoto's Casket of Souls won second place in the Warhammer Large Model category at the 2004 Canadian Games Day Golden Demon painting competition.

Many thousands of years ago, the ancient realm of Nehekhara was a vibrant civilization of Men that rose like an oasis of life in the vast deserts of the Warhammer world. But long ago, dark necromantic magic tainted and destroyed the realm and left only corpses and the remains of ruined cities and mighty tombs. The land was cursed, but soon the dead rose up and reclaimed their kingdom.

Fighting Style

No force in the Warhammer world relies as heavily on its characters as the Tomb Kings army. After all, the soldiers have risen out of their sandy graves only because of the incantations of the Liche Priests and the indomitable will of the Tomb Kings and Princes. While Tomb Kings units are solid and never rout, they are not the hardest-hitting or most skillful troops in the game. There are some fearsome combatants in the army list (Bone Giants and Ushabti for instance), but what makes the Tomb Kings so deadly is their ability to use Incantations to gain extra movement, shooting, and fighting from their Undead legions. Additionally, the character models can resurrect casualties and

continually bring back models their foes have destroyed. Like the very sands of their desert home, the numbers of the Tomb King army can seem limitless to a dismayed opponent.

Tomb Kings players can use their powerful characters and ability to control the Undead to make an army with a lot of missile weapons, a fast attack force of hard-hitting Chariots and Bone Giants, or a fearsome frontal assault force with outflanking possibilities. With its myriad of spell casters and special deploying creatures like Tomb Swarms and Tomb Scorpions, a wizened and veteran Tomb Kings player can keep his foe guessing until the final (and fatal) attack is launched.

Collecting a Tomb Kings Army

The best two things to begin a Tomb Kings army with are Skeletons and some character models. In order to raise a mighty Undead host, you must have Skeletons. There are a variety of options and equipment (Skeleton Light Horsemen, Skeletons with spears and shields, Skeletons with bows, and more), and a player would be wise to consider how he

intends to use each unit before starting in with the painting and assembling. An army must also contain at least one Tomb King or Prince to be its General and at least one Liche Priest or Liche High Priest to be the army's Hierophant (the one responsible for waking the entire force from slumber).

When expanding a Tomb Kings army, it is always advisable to take every character model that you can to ensure plenty of incantations to drive the legions. Once characters are assembled, players can fill out their army with not only rank after rank of Undead warriors but also things like the powerful Screaming Skull Catapult, flying Carrion, elite Tomb Guard, or Undead Constructs like the guardian statues known as Ushabti, the terrifying Bone Giant, or the Tomb Scorpions. Tomb Swarms are ideal to burst out of the sand and tie up enemy units. It is next to impossible to have too many Skeletons, and luckily they are fast to paint up and will look great in your army.

With so many choices, Tomb King players are well equipped to raise their own Army of Eternity and reclaim their ancient kingdoms.



Tomb Kings Battalion 99120207006

- 2 Regiments of 16 Skeleton Warriors
- 3 Chariots
- 8 Skeleton Horsemen

This boxed set contains the perfect foundation for a new Tomb Kings army. Simply add a character model or two, and you're almost there!



GETTING STARTED

This book contains all of the information you need to build a Tomb Kings army and includes full rules, the army list, collecting and hobby tips, and colorful, in-depth background information.

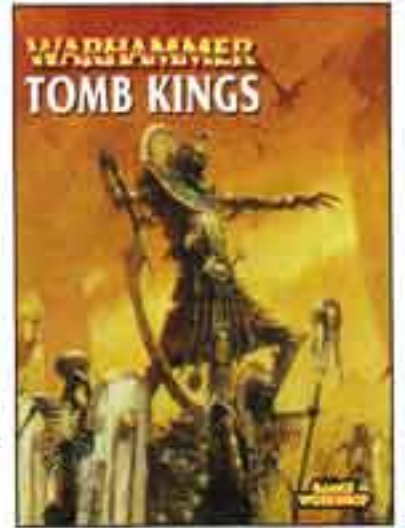

**Warhammer Armies:
Tomb Kings**
60030207003



Skeleton Warrior Regiment Box (16) 99120207003

As with most Warhammer armies, the best place to start recruiting your forces is with a plastic regiment boxed set. In the case of the Tomb Kings, the Skeleton Warriors boxed set is the obvious choice. With the contents of this boxed set, you can assemble a regiment of 16 plastic Skeleton Warriors, including command, to take to battle on the sands of Khemri. You also have the option of arming them one of three different ways. Your Skeletons can have hand weapons, spears, or bows (all three of which are shown here). While there are plenty of other troop types to choose from, the foundations of any good Tomb Kings army are plenty of animated skeletal remains.



Skeleton Warriors with Hand Weapons and Shields



Skeleton Warriors with Spears and Shields



Skeleton Warriors with Bows

These Skeletons are shown at approximately 85% actual size.

All illustrations are subject to copyright. Models, lists, and prices are all shown at actual size unless otherwise noted. Contents may vary slightly from those shown.

LORDS & HEROES

TOMB KINGS GOLD

The gold on most of the weapons, equipment, and other accouterments that the Tomb Kings possess generally has a distinctly aged look to it, as you might expect since these items have been entombed with their owners for centuries. Here's our method for achieving that "died-in" look.



Step 1. Undercoat with black and basecoat with a mix of one part Shining Gold and one part Vermin Brown.



Step 2. Give the entire gold area a thinned wash of Scorched Brown.



Step 3. Highlight with a mix of three parts Shining Gold to one part Vermin Brown.



Step 4. Add the final level of highlight with unmingled Shining Gold.

More tips on painting gold can be found in the Dark Elf and Necron sections in this very catalog!



ALTAIR REAR
9947020711607



CASSET OF SOULS
9947020711604



ALTAIR FRONT
9947020711606



VULTURE SPRUE
9947020711611



LICHE PRIEST BODY
9947020711602



LICHE PRIEST RIGHT ARM
9947020711601



LICHE PRIEST LEFT ARM
9947020711603



SKELETON TORSO SPRUE
9947020711610



CASSET BASE
9947020711605



GUARD BODY 1
9947020711608



GUARD BODY 2
9947020711612



GUARD SWORDS SPRUE
9947020711609



The Casket of Souls Box (1)
99110207116





LORDS & HEROES



Settra the Imperishable Box (1)
99110207110



SETTRA RIGHT WEAPON ARM
9947020711003



SETTRA CHARIOT HAFT
9947020711008



SETTRA CHARIOT YOKE
9947020711005



SETTRA LEFT ARM SPRUE
9947020711001



SETTRA BODY
9947020711002



SETTRA CLOAK
9947020711004



SETTRA CHARIOT STANDARD TOP
9947020711006



SETTRA CHARIOT BANNER POLE
9947020711010



SETTRA CHARIOT SKELETON ICON
9947020711007

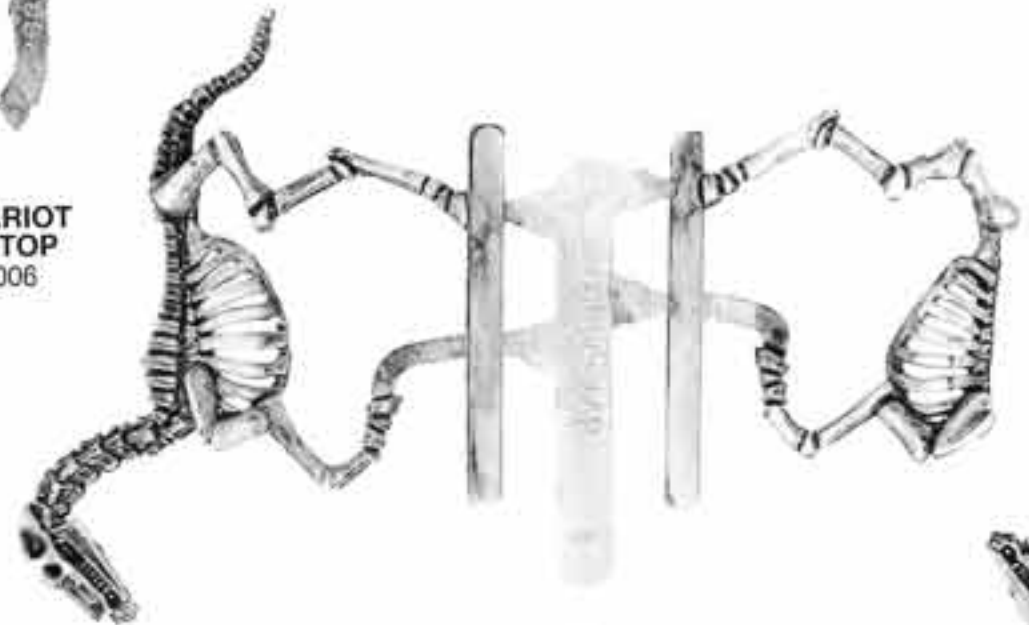

SETTRA CHARIOT FRONT
9947020711009



SETTRA CHARIOT WHEEL
9947020711015



SETTRA CHARIOT SCYTHE
9947020711011



SETTRA CHARIOT RIGHT SIDE
9947020711014



SETTRA CHARIOT LEFT SIDE
9947020711012



SETTRA CHARIOT BASE
9947020711013

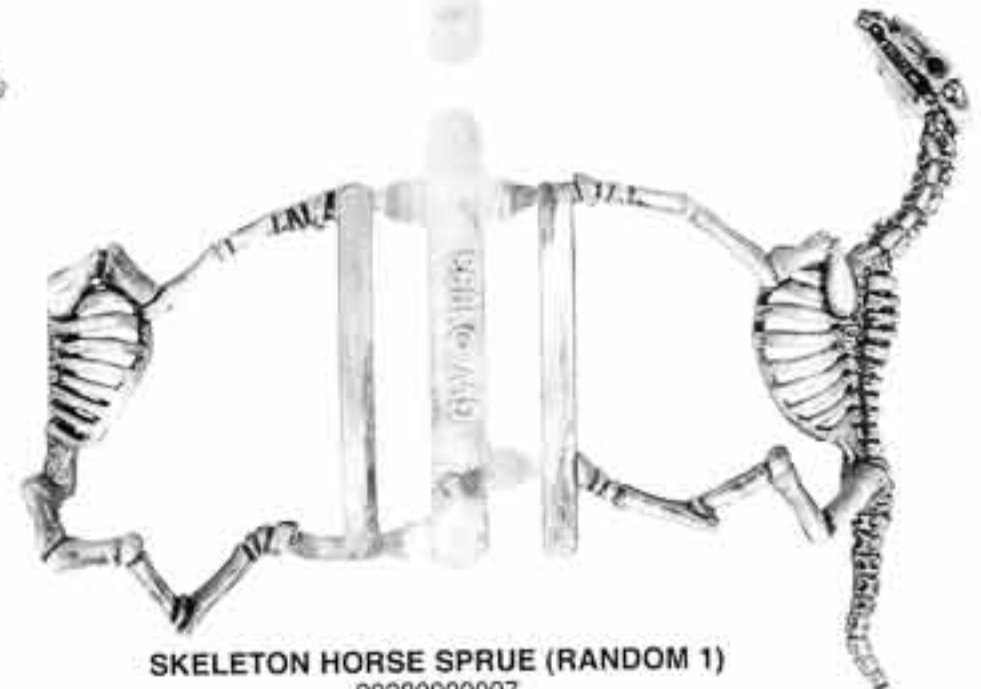

SKELETON HORSE SPRUE (RANDOM 1)
99389999007



LORDS & HEROES



The Tomb King in Chariot includes the Skeleton Horse Sprue (99389999007) and the Tomb King 2 Left Arm (9947020711705) shown on the previous page.



TOMB KING 3 BODY
9947020712402



TOMB KING 3 RIGHT ARM
9947020712401



Tomb King in Chariot Box (1)
99110207124

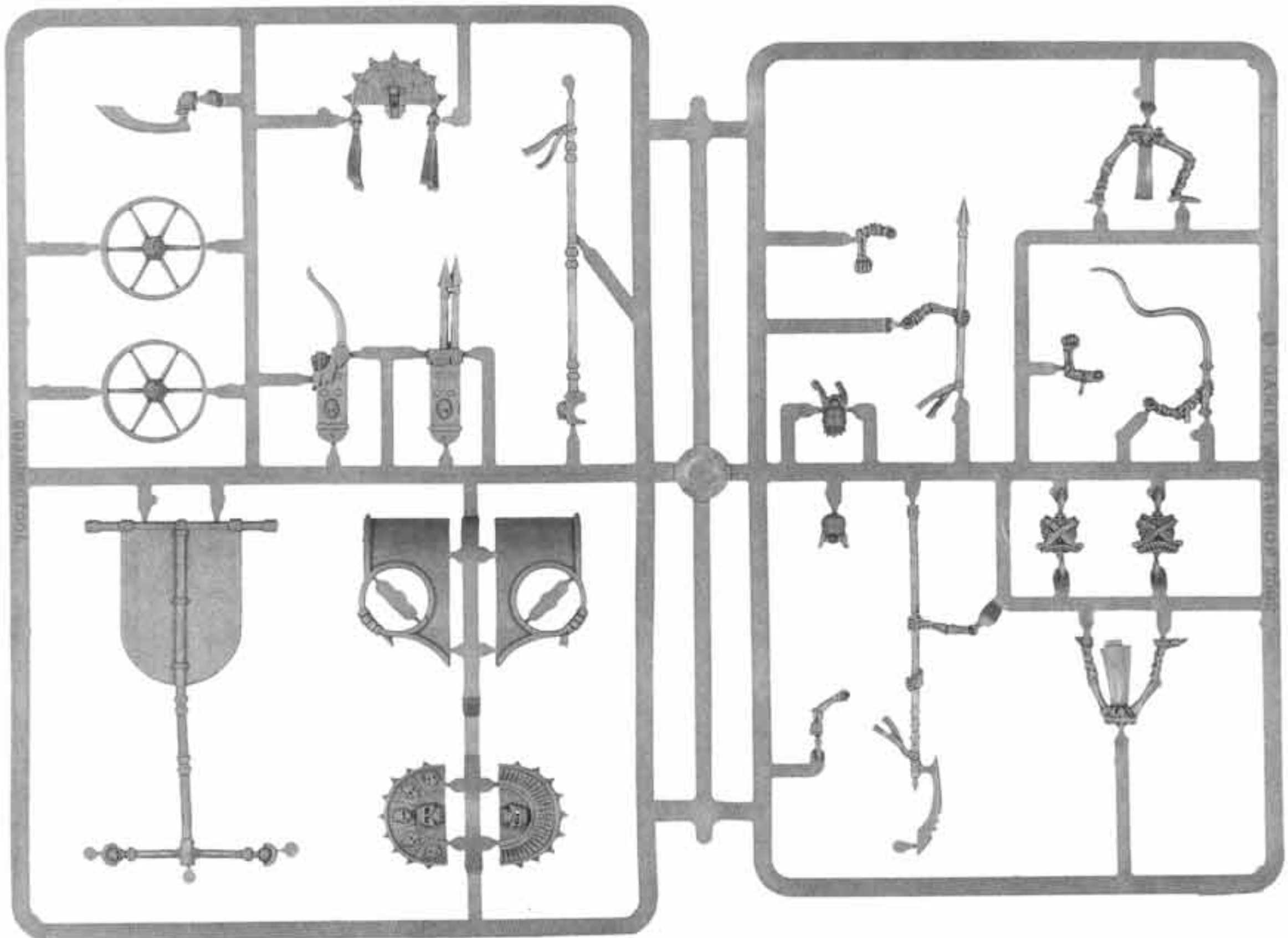

TOMB KINGS CHARIOT SPRUE (SHOWN 85% ACTUAL SIZE)
99380207005



LORDS & HEROES



Tomb King Blister (Random 1)
99060207117



TOMB KING BODY 2
9947020711703



TOMB KING BODY 1
9947020711701



TOMB KING 1 SHIELD
9947020711702

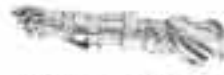

TOMB KING 2 LEFT ARM
9947020711705



TOMB KING 2 GLAIVE
9947020711704



Liche Priests Blister (2)
99060207113

The Liche Priests come with the Skeleton Horse Sprue (99389999007) shown earlier.



MOUNTED LICHE PRIEST
9947020711302



LICHE PRIEST ON FOOT
9947020711301



LORDS & HEROES



High Queen Khalida Neferher Blister (1)
99060207120
BIT NAME: TOMB QUEEN
BIT CODE: 9947020712001



Icon Bearers Blister (2)
99060207123



ICON BEARER BODY
9947020711201



MOUNTED ICON BEARER BODY
9947020712301



ICON BEARER ARM 1
9947020712302



ICON BEARER ARM 2
9947020712303



ARMY ICON 2
9947020712304

The Icon Bearers come with the Skeleton Horse Sprue (99389999007) shown earlier.



CORE UNITS

Skeleton Warrior Regiment Box (16)
99120207003

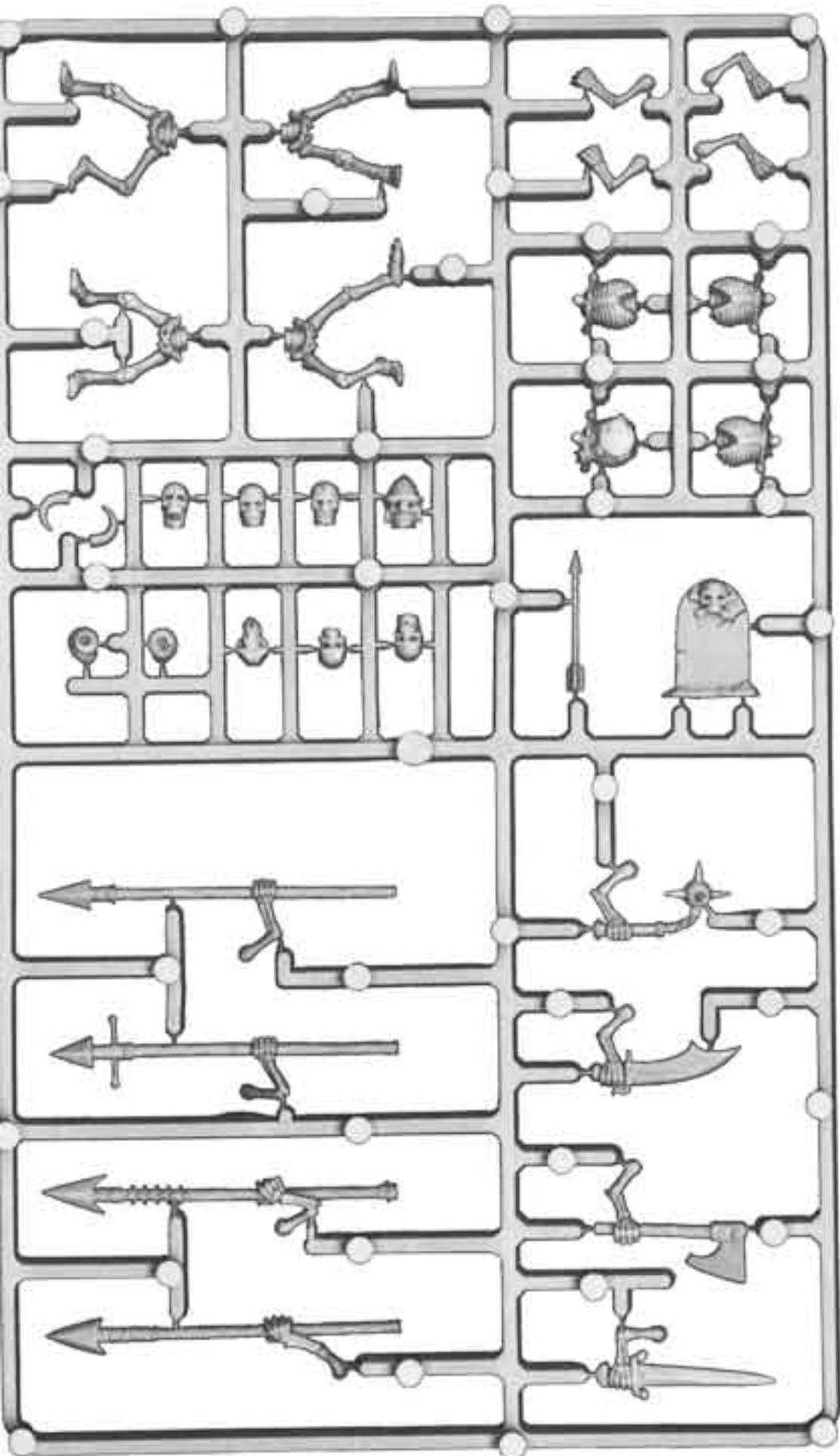

SKELETON WARRIOR SPRUE (SHOWN 75% ACT. SIZE)
99380207001

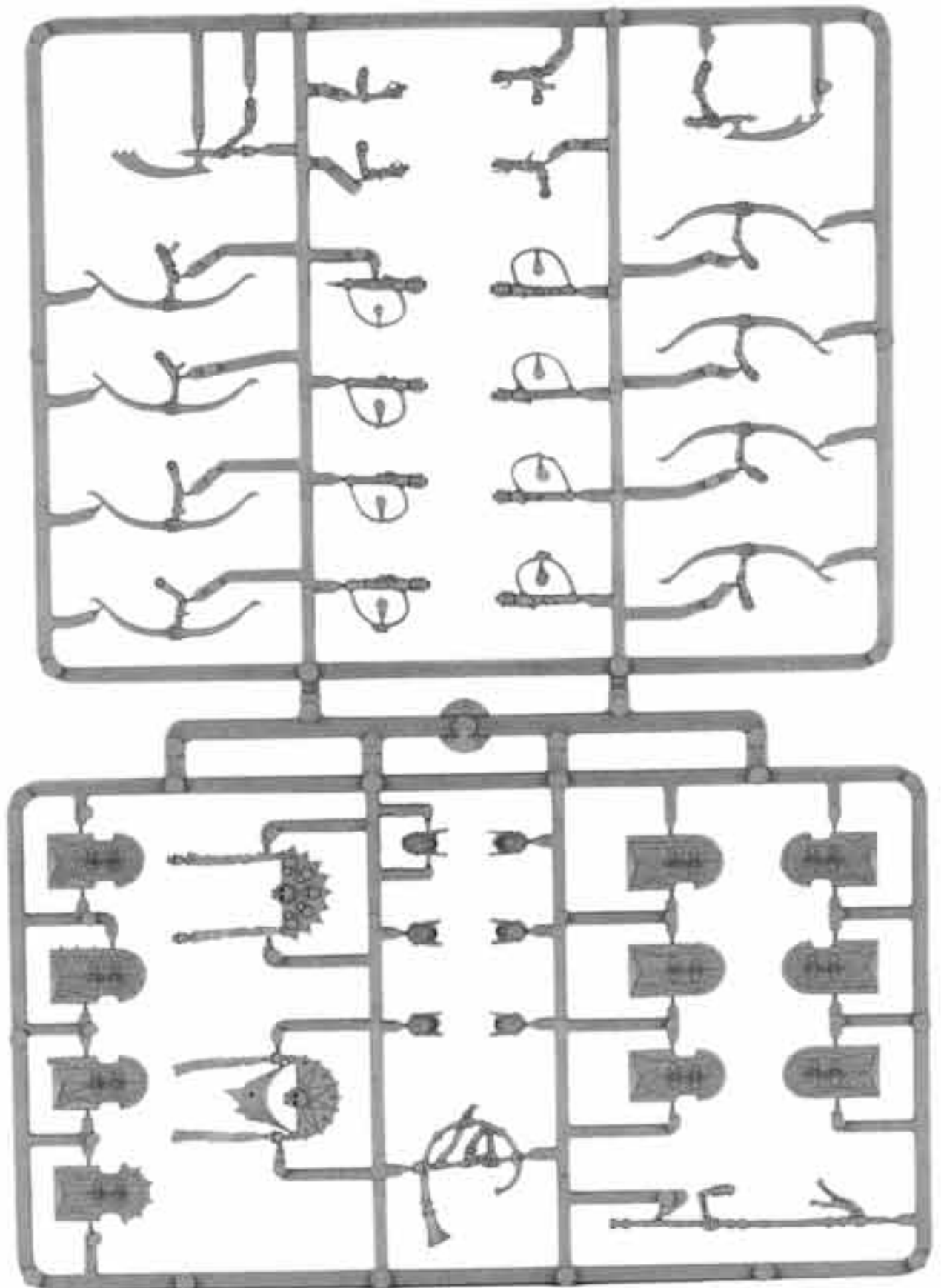

TOMB KING INFANTRY SPRUE (SHOWN 75% ACT. SIZE)
99380207003

All miniatures are supplied unpainted. Models, lists, and sprues are all shown at actual size unless otherwise noted. Contents may vary slightly from those shown.



CORE UNITS



The Skeleton Chariot Regiment boxed set includes the Skeleton Horse Sprue (99389999007), the Tomb Kings Chariot Sprue (99380207005), and the Tomb Kings Infantry Sprue (99380207003) shown earlier.



Skeleton Chariot Regiment Box (3)
99120207005



Tomb Swarm Blister (2)
99060207125



TOMB SWARM 1
9947020711401



TOMB SWARM 2
9947020711402





CORE UNITS

STEP-BY-STEP SKELETONS

Here are a couple of relatively quick and easy methods for painting Skeletons in a hurry without sacrificing painting quality. After a few rounds of either method, your legions of Undead will become too numerous for opponents to withstand.

Here is the simplest method for painting a Skeleton in a hurry.



Undercoat the model with Skull White spray.
Apply a wash of Brown Ink thinned with an equal amount of water.



Drybrush the entire model with Bleached Bone.

Here's a more detailed method used by the 'Eavy Metal team to paint the U.K. Studio army featured in *White Dwarf*.



Undercoat the model with Skull White.
Apply a wash of Brown Ink thinned with an equal quantity of water.
Give the weapon an undercoat of Chaos Black after the ink dries.



Drybrush Bleached Bone across the body of the model.
Paint the weapon with a basecoat of Brazen Brass and then give it a thin wash of Chestnut Ink.



Apply highlights of Skull White to raised sections and ridges of bone. Pay particular attention to the highlights on the face.
Highlight the weapon with an equal mix of Brazen Brass and Mithril Silver.



Skeleton Horsemen Regiment Box (8)
99120207004

The Skeleton Horsemen Regiment boxed set includes the Skeleton Horse Sprue (99389999007) and the Tomb Kings Infantry Sprue (99380207003) shown earlier.

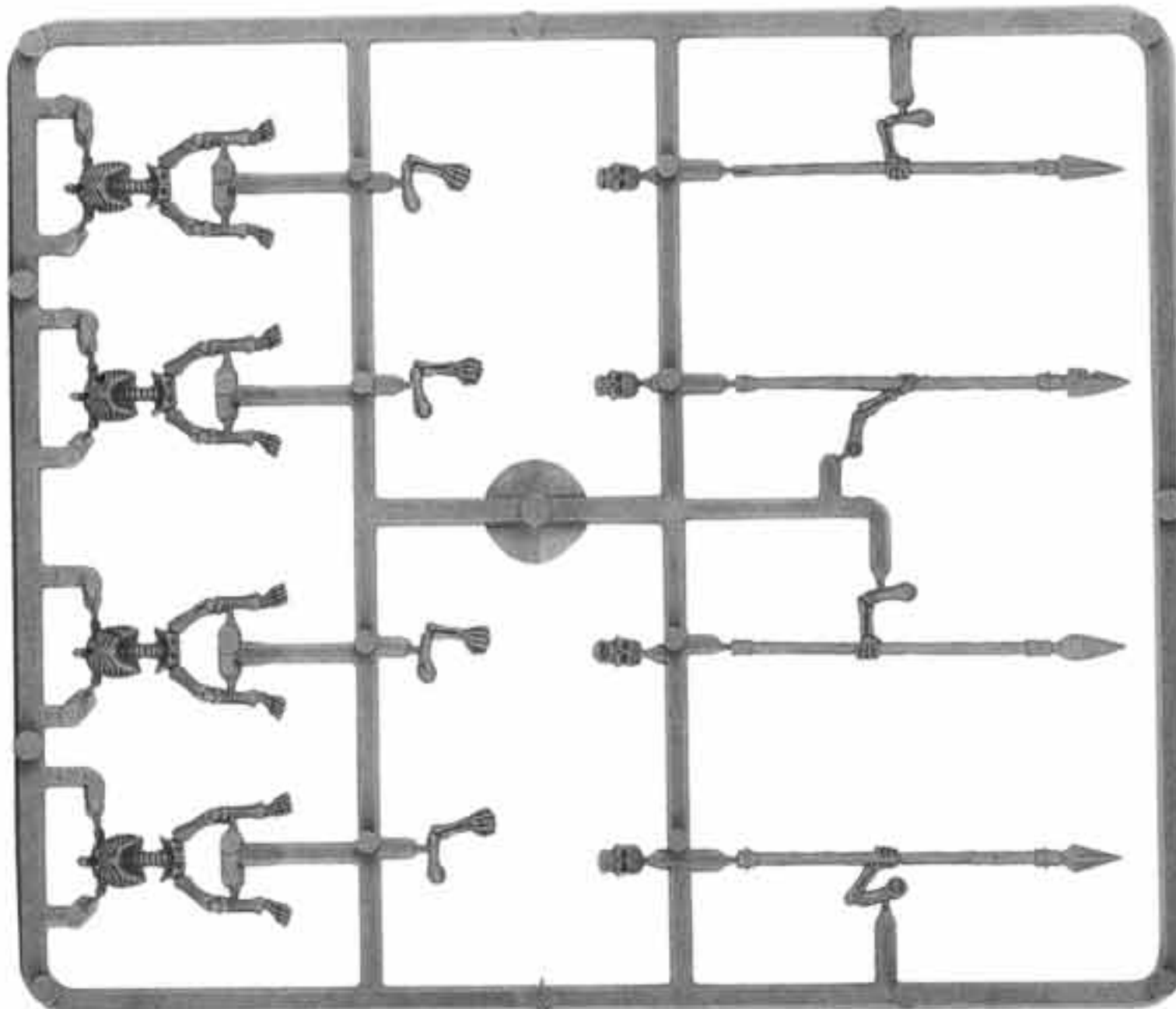

TOMB KING CAVALRY SPRUE (SHOWN 75% ACT. SIZE)
99380207004

SPECIAL UNITS



Ushabti Blister (Random 1)
99060207118



USHABTI BODY 1
9947020711801



USHABTI BODY 2
9947020711802



USHABTI BODY 3
9947020711803



USHABTI BODY 4
9947020711804



USHABTI RITUAL BLADE 1
9947020711805



USHABTI RITUAL BLADE 3
9947020711807



USHABTI RITUAL BLADE 2
9947020711806



USHABTI RITUAL BLADE 4
9947020711808



Tomb Guard Regiment Box (Random 10) & Command Blister (3)
99110207122 99060207121

SPECIAL UNITS

PAINTING SHIELDS

As you'll notice in the *Colors of War* section later on, shields are a prominent part of the Tomb Kings army, can be used to make your army look unique, and will help differentiate between units. Using colors that contrast with the bone that makes up most of the force will help your models stand out on the battlefield. We have used a simple color scheme for our army and this example here, but as the examples in the *Colors of War* section show, you can use more complex patterns to personalize your shields. The shield in the example below is shown separate from the sprue, but shields can be painted more easily and quickly if they're left on the sprue. Try it each way and see which works best for you.



STEP 1

Undercoat the shield black or white (the colors in this instance dictate the use of a black undercoat).



STEP 2

Basecoat the shield with your chosen colors.



STEP 3

Shade the colors in the recesses of the shield and put an ink wash on any areas painted with metallic colors.



STEP 4

Highlight the edges and other raised surfaces with lighter shades of color and paint the original metallic color over the inked areas.



TOMB GUARD 2
9947020712202



TOMB GUARD 4
9947020712204



TOMB GUARD 1
9947020712201



TOMB GUARD 3
9947020712203



TOMB GUARD SHIELD 1
9947020712205



TOMB GUARD SHIELD 2
9947020712206



TOMB GUARD CHAMPION
9947020712101



TOMB GUARD MUSICIAN
9947020712102



TOMB GUARD STANDARD BEARER
9947020712103



TOMB GUARD STANDARD TOP
9947020712104



TOMB GUARD SHIELD 3
9947020712207



TOMB GUARD SHIELD 4
9947020712208

The Tomb Guard Command blister includes two random Tomb Guard shields.

All miniature are supplied unpainted. Models, line, and sprues are all shown as they will appear when assembled. Contents may vary slightly from those shown.



SPECIAL UNITS

DESERT BASES

At first glance, all the sand on which the armies of the Tomb Kings trod to war may look the same. However, on closer inspection, one might see a number of variations in the color, texture, and other features. Below, we describe a few different ways to base your army. All of the bases below were undercoated white.



Basecoat with Vomit Brown. Drybrush progressively lighter highlights of Bubonic Brown, Bleached Bone, and Skull White.



Basecoat with Desert Yellow. Drybrush progressively lighter highlights of Kommando Khaki, Bleached Bone, and Skull White.



You can also add extra character to your bases by using spare bitz from the Skeleton Sprue or metal bitz like the horned skull or the classic Tomb Swarm scorpion shown. Try out different bitz and see what works for you.



Carrion Blister (Random 1)

99060207119



CARRION BODY 1
9947020711903



CARRION WINGS 1
9947020711905



CARRION HEAD 1
9947020711901



CARRION BODY 2
9947020711904



CARRION WINGS 2
9947020711906



CARRION HEAD 2
9947020711902



TOMB SCORPION LEFT CLAW
9947020711501



TOMB SCORPION RIGHT CLAW
9947020711503



Tomb Scorpion Blister (1)

99060207115

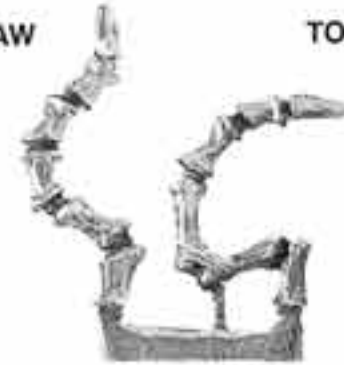

TOMB SCORPION LEGS SPRUE
9947020711505



TOMB SCORPION BODY
9947020711502



TOMB SCORPION TAIL
9947020711504

RARE UNITS

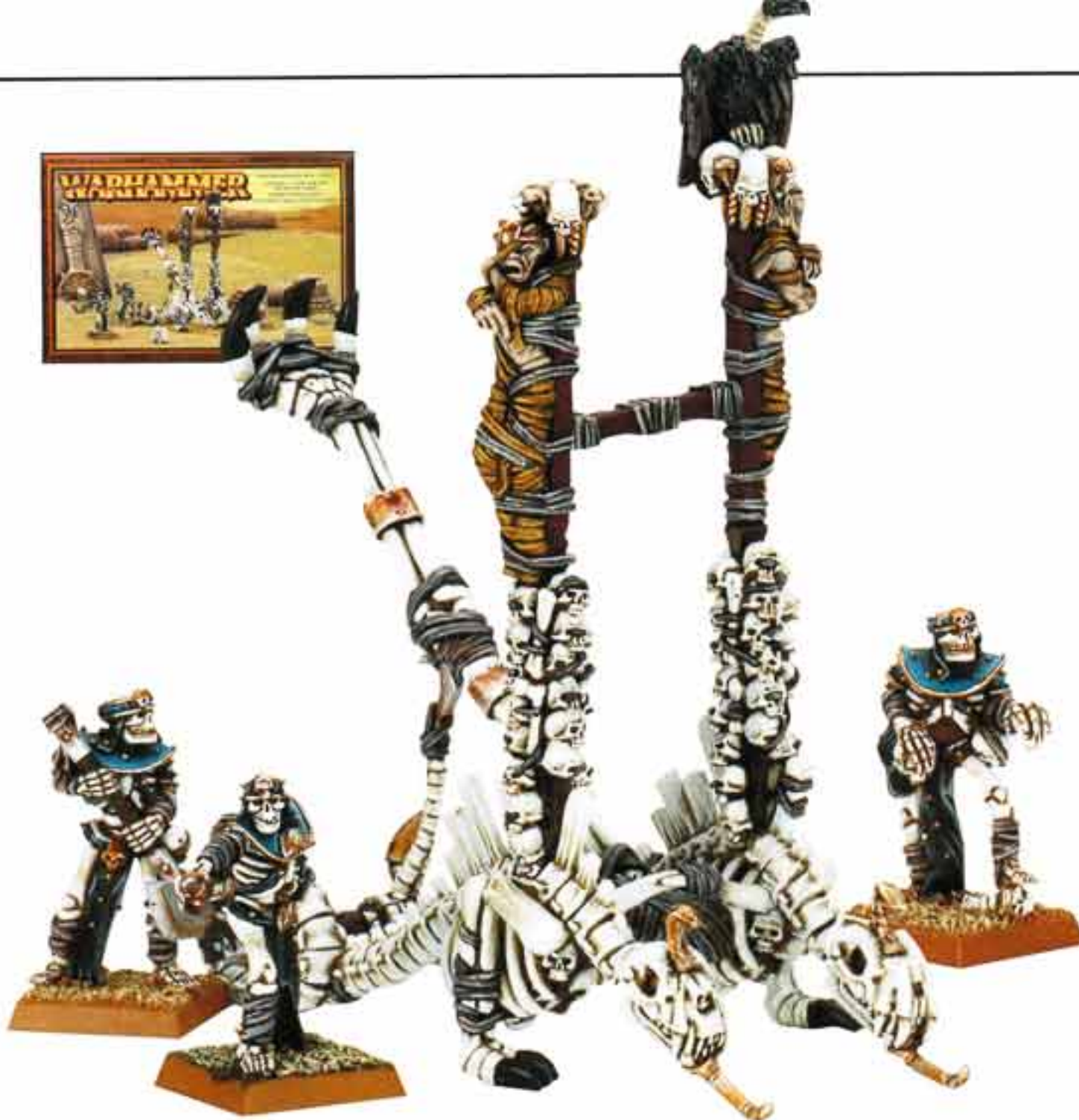

Screaming Skull Catapult Box (1)
99110207111



CATAPULT POLE 2
9947020711108



CATAPULT POLE 1
9947020711106



CATAPULT ARM
9947020711107



CATAPULT CREW 1
9947020711101



CATAPULT CREW 2
9947020711102



CATAPULT CREW 3
9947020711103



CATAPULT SPRUE 1
9947020711114



CATAPULT SPRUE 2
9947020711115



CATAPULT TAIL 1
9947020711105



CATAPULT WINCH
9947020711109



CATAPULT LEVER
9947020711112



CATAPULT CROSS BEAM
9947020711113



CATAPULT SKULLS
9947020711116



CATAPULT TAIL 2
9947020711111



CATAPULT LEFT SIDE
9947020711104



CATAPULT RIGHT SIDE
9947020711110



CATAPULT VULTURE
9947020711117

RARE UNITS

"THE DIP"

"The dip" is an alternate way of painting models. It allows you to paint loads of miniatures quickly. In fact, whole units can be painted in an evening, an army in a week. The basic idea behind it is a complete model wash. The process is to basecoat the miniature entirely, dip it, let it dry, and then finish the base on the model. The "dip" itself is a stain or a colored varnish (found at a hardware store). In this example, we've use Behr EuroColour Water Base Wood Stain Victorian Mahogany. Some water-based products can be diluted to get the right color consistency for your particular projects. Dark stains work best. Some varnishes, like Minwax, also provide a protective coating when finished.



Undercoat the models with white. You can either paint the body with Bleached Bone or leave it white. Basecoat the rest of the model before dipping.



Fill a large-mouthed cup with your varnish/stain mixture and dip the entire model into it. Use a brush to pull the excess material off of the base of the

model. Be sure to put down plenty of paper to soak up any spills or drips as you're dipping. Let the model dry overnight.



Finish the bases to match your army, and you're well on your way.

You can use this method on any number of armies, but you might have to practice with some test models to see what the colors will do and how you like the effect.



BONE GIANT BASE
9947020710909

Bone Giant Box (1)
99110207109



BONE GIANT HEAD 1 (SKELETONS)
9947020710901



BONE GIANT HEAD 2 (BARE)
9947020710902



BONE GIANT TORSO
9947020710904



BONE GIANT RIGHT ARM
9947020710903



BONE GIANT HIPS
9947020710907



BONE GIANT LEFT ARM
9947020710905



BONE GIANT RIGHT LEG
9947020710906



BONE GIANT LEFT LEG
9947020710908

TACTICS



TIPS FOR WINNING WITH TOMB KINGS

A. Tomb Kings armies are capable of charging on the 1st turn. When deploying your forces, delay placing Carrion until your opponent has placed his war machines. Once he has done so, put your unit of Carrion in a position no more than 36" or so away from the war machine. In the Movement Phase, advance toward your chosen war machine (lone Wizards also make great targets!), but keep your Liche Priest within 12" of the Carrion. In the Magic Phase, use your Tomb King's incantation to fire your Screaming Skull Catapults – your opponent is very likely to try and stop this incantation. Next, your Liche Priest can move the Carrion with his incantation. You should be able to engage in hand-to-hand combat in the 1st turn and take out a major threat with a small 72-point unit. Even if the Carrion fail to destroy the enemy models, the war machine (or other expensive target) will be tied up in combat while you advance during the next turn. If the enemy has no war machines, you can pick on a character (even if he is in a unit) or simply get behind the enemy to prevent marching.

B. Another bit of fun can be had with a simple unit of three Chariots with the Banner of the Undying Legion. Most people see Chariots and overestimate the threat they present. Many Warhammer players are used to seeing Chaos, Orc, and even Elf Chariots and the damage they can do. When presented with three Chariots, it is easy for an opponent to focus on them too much. Eventually, most opponents will realize that three Tomb Kings Chariots are less of a threat than one Chaos Chariot. Until then, however, many opponents will throw a lot of ranged attacks and magic missiles into this unit in hopes of killing it. Luckily for you, the Banner of the Undying Legion will keep it going, and going, and going. Try advancing your Chariots toward enemy shooting units (like archers and crossbowmen). These units will usually shoot at your Chariots. Next, have your Chariots retreat and begin the healing process. Most of the time, the opponent will not want his hard work to go to waste and will usually use two Dispel Dice to prevent the banner from working. If that happens, you have gained a great advantage. Because your opponent has used up some of his Dispel Dice, you will be able to cast the incantations that really matter!

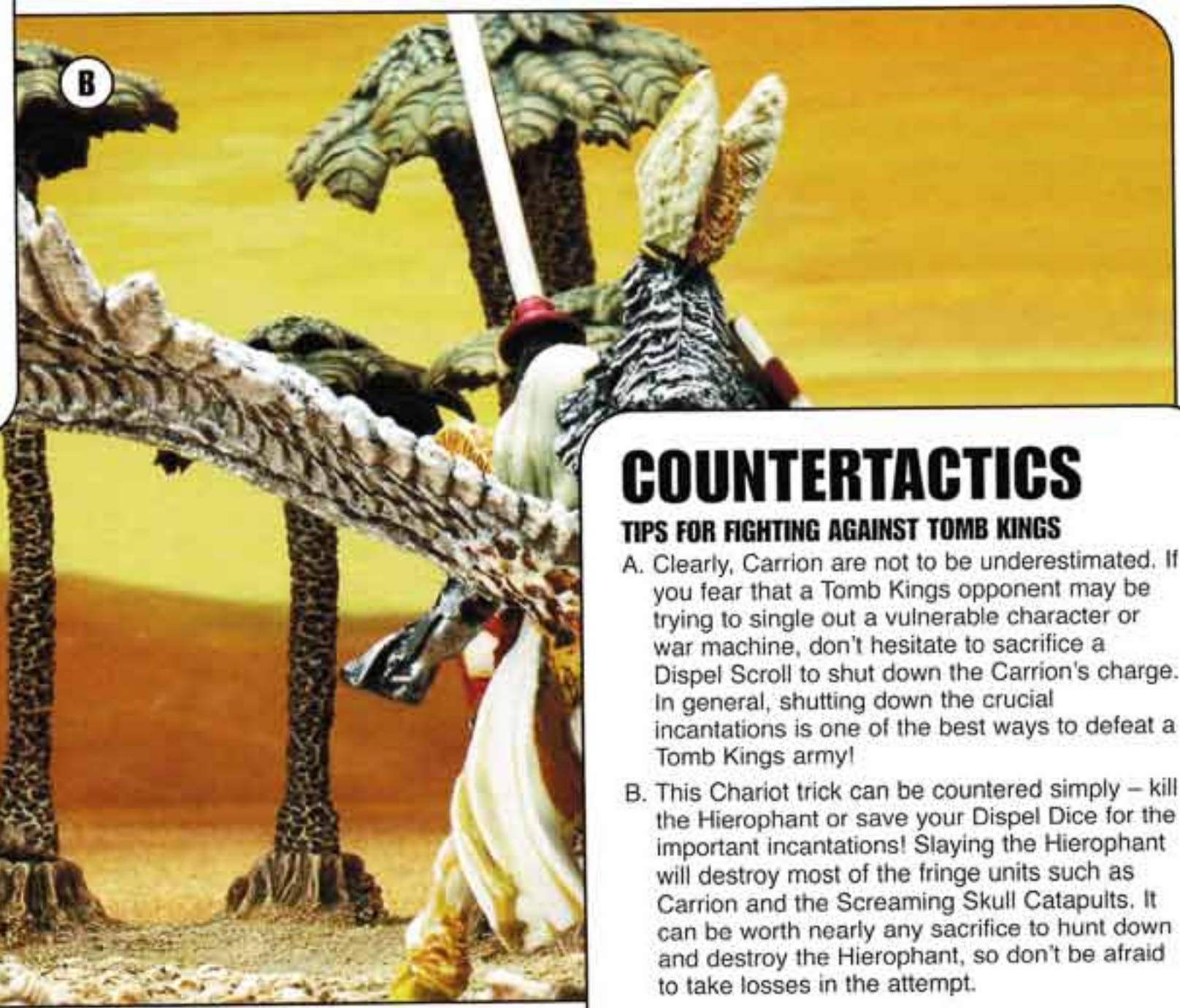

COUNTERTACTICS

TIPS FOR FIGHTING AGAINST TOMB KINGS

- A. Clearly, Carrion are not to be underestimated. If you fear that a Tomb Kings opponent may be trying to single out a vulnerable character or war machine, don't hesitate to sacrifice a Dispel Scroll to shut down the Carrion's charge. In general, shutting down the crucial incantations is one of the best ways to defeat a Tomb Kings army!
- B. This Chariot trick can be countered simply – kill the Hierophant or save your Dispel Dice for the important incantations! Slaying the Hierophant will destroy most of the fringe units such as Carrion and the Screaming Skull Catapults. It can be worth nearly any sacrifice to hunt down and destroy the Hierophant, so don't be afraid to take losses in the attempt.

COLORS OF WAR



KEY

■ Top Box(es): Basecoat Colors & Ink Washes

■ Bottom Box(es): Highlights

■ Mixed Colors



Skull White, Black Ink
Skull White



Skull White, Flesh Wash
Bleached Bone, Skull White



Skull White, Brown Ink
Bleached Bone, Skull White



Bronzed Flesh, Brown Ink
Bleached Bone, Skull White



Bubonic Brown, Red Gore
Bleached Bone, Blood Red

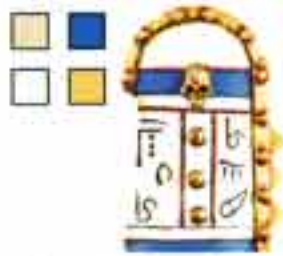

Bleached Bone, Ultramarine Blue
Skull White, Burnished Gold



Scab Red, Chainmail
Blood Red, Dwarf Bronze



Bubonic Brown, Ultramarine Blue
Bleached Bone, Chainmail



Scab Red, Dwarf Bronze
Blood Red, Burnished Gold



Bleached Bone, Chaos Black
Skull White, Burnished Gold



Brazen Brass, Chaos Black
Shining Gold, Chainmail



Regal Blue, Dwarf Bronze
Enchanted Blue, Burnished Gold



Chaos Black, Chainmail
Fortress Grey, Flesh Wash



Enchanted Blue, Dwarf Bronze
Ice Blue, Mithril Silver

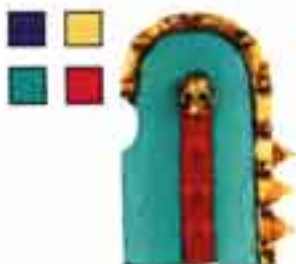

Regal Blue, Burnished Gold
Hawk Turquoise, Blood Red



Regal Blue, Golden Yellow
Enchanted Blue, Bad Moon Yellow



Snakebite Leather, Blood Red
Bubonic Brown, Golden Yellow



Bleached Bone, Dwarf Bronze
Skull White, Burnished Gold

SHOWCASE



Above: Here is a Bone Giant by Mark Bedford from the 2003 Storm of Chaos campaign.

Left: Ben Bishop entered this stunning Tomb Queen in the 2003 Canadian Golden Demon Painting competition and came home with a first place trophy for his efforts.



ALTERNATE MODEL – LORDS & HEROES Tomb King on Foot

COMPONENTS FOR 1 COMPLETE MODEL

- 9947020711701 Tomb King Body 1
- 9947020711702 Tomb King Shield
- 9947020712303 Icon Bearer Arm 2
- 99380207003 Tomb King Infantry Sprue
- 9947011000901 Necron Lord Body
- 9947020711006 Settra Standard Top

COMPLEXITY RATING



ALTERNATE MODEL – LORDS & HEROES Tomb King in Chariot

COMPONENTS FOR 1 COMPLETE MODEL

- 99380207005 Tomb King Chariot Sprue
- 99389999007 Skeleton Horse Sprue
- 99390110002 Necron Destroyer Sprue
- 9947011001603 N. Destroyer Lord Arm Sprue
- 9947020711008 Settra's Chariot Haft
- 9947020711611 Casket of Souls Vulture Sp.

COMPLEXITY RATING



All miniatures are supplied unpainted. Models, bits, and sprues are all shown actual size unless otherwise noted. Contents may vary slightly from those shown.

VAMPIRE COUNTS

The land of Sylvania is a cheerless place that travelers are warned to avoid at all costs. It is full of dark tangled forests and barren hills crowned by gloomy ruins. Over 500 years ago, the dreaded Von Carstein Vampires took hold of the country and marched openly to war against the Empire. To this day, the Sylvanian people are backward. They fear to go out after nightfall and surround themselves with charms and banes. However, all that ancient evil was banished long ago. The recent outcries of the peasants over missing family members and the return of the bad old days are nothing but rumor. The Sylvanians always were a superstitious people.

Long-dead warriors march again, this time under tattered banners raised by skeletal hands. Evil magics awaken corpses and bind ethereal creatures to fight once more for cruel masters bent on revenge, conquest, and immortality.

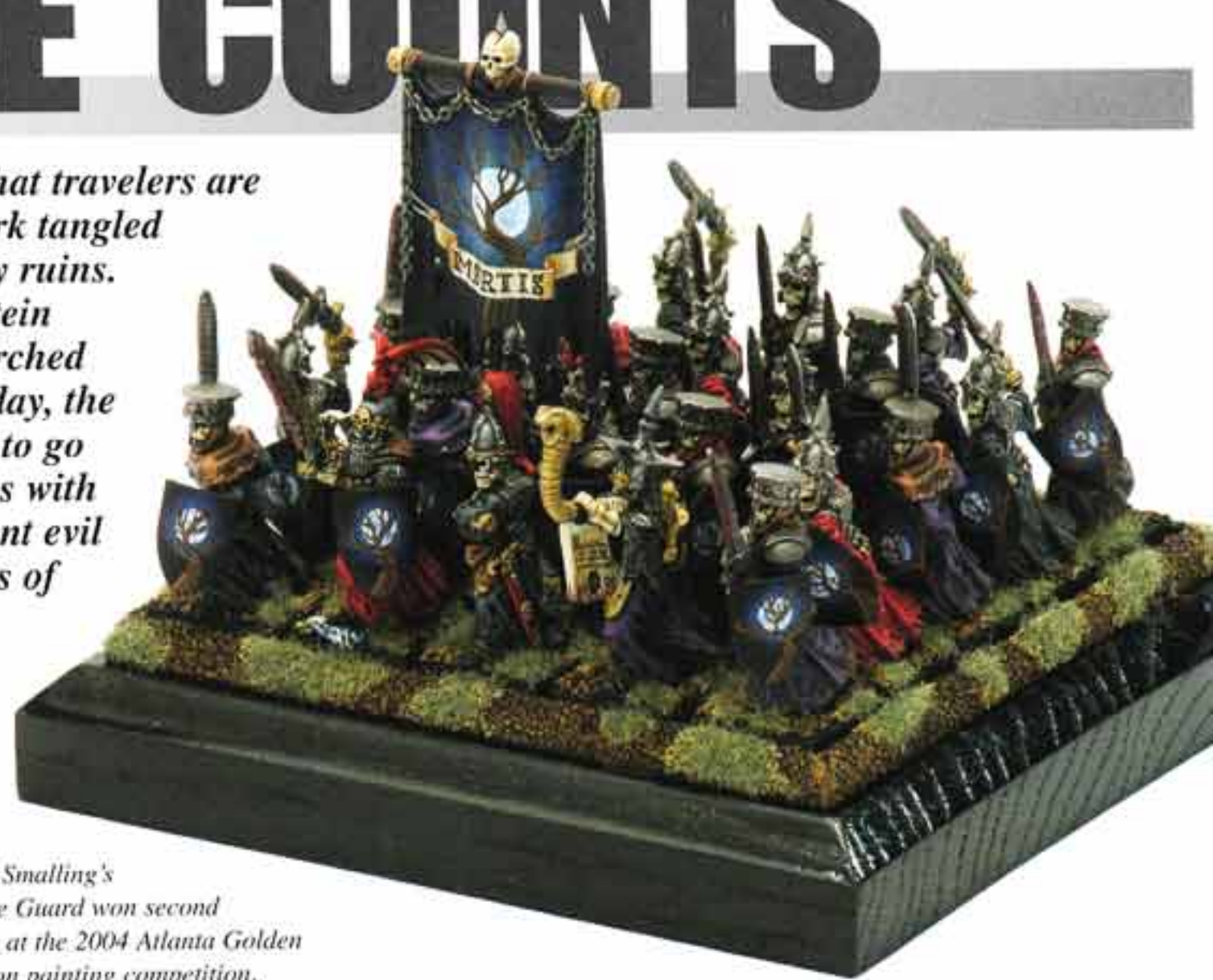

Greg Smalling's Grave Guard won second place at the 2004 Atlanta Golden Demon painting competition.

Fighting Style

The Undead fight differently than any other army in the Warhammer world. Relying on fear, shambling hordes of Skeletons and Zombies advance to tie down the foe. Fell Bats and Dire Wolves attack along the flanks to negate enemy ranks, while Grave Guard and Black Knights wield their deadly Wight Blades to slice down the foe. The Ethereal Banshee can disrupt enemy units with its Ghostly Howl, and the deadly Black Coach causes *Terror* and hits units like a Chariot. Even worse, with their powerful Necromantic magics, the Undead can replenish casualties or even summon whole new units of Skeletons or Zombies.

The fighting style of a Vampire Count's army partly depends on which Bloodline the player selects. There are five Bloodlines: Von Carstein, Necrarch, Blood Dragon, Lahmia, and Strigoi. While all Vampires are imposing enemies and use the same troop types, each Bloodline has a different specialty that can greatly affect a player's overall strategy. For instance, Blood Dragons are the most powerful fighters of all Vampire kind, but in gaining their combat skills, their Magic is reduced. Blood Dragon players will put more emphasis on breaking the foe in hand to hand and rely less on the Magic Phase. The Lahmia are less skilled in weaponry than Blood Dragons are but compensate with a range of beguiling and seducing abilities that can freeze attackers

and possibly even cause them to switch sides. Necrarchs are the weakest in hand-to-hand combat but conversely are the most powerful Necromancers.

Collecting a Vampire Count Army

Before a Vampire Count can begin his or her quest for domination, some Core troops must be raised. Skeletons and Zombies serve as the mainstay for most Vampire Counts armies. While neither of these troop types will win many fair fights on their own (without a little bit of luck), they are excellent at pinning the enemy in place. Ghouls, with their *Poisoned Attacks* and *Skirmish* formation, can make a threatening flanking unit.

When enlarging an army, a few harder hitting units aren't a bad idea. Grave Guard, Black Knights, and the Black Coach will make even the staunchest of foes pause. Banshees and Spirit Hosts can be wounded only by magical attacks and make for great battlefield distractions. Fell Bats and Dire Wolves are speedy additions, great for taking out enemy war machines or small flanking units.

The cold heart of the army that drives the whole rotting force forward is, without a doubt, the Vampires. A Vampire Lord or Count can more than make up for the combat inadequacies of Skeletons and Zombies! Additionally lesser Vampires (Thralls), Necromancers, Wight Lords, or Wraiths can lead units of the Undead. Rise up and lead your dark legions to blood and victory!



Joe Hill's Graveyard Encounter won first place at the 2004 U.K. Golden Demon painting competition in the Duel Category.

GETTING STARTED

Large regiments of Skeletons form the backbone of the Vampire Count army. Skeletons are the standard Undead troops. You can either buy lots of them without equipment or take fewer well-equipped ones and plan to raise some more during the game with magic spells.



This 80-page rulebook contains painting and modeling guides, background, and the full rules for fielding a Vampire Count army.



Warhammer Armies:
Vampire Counts
60030207002

The Skeleton Regiment boxed set is a great place to start building your Vampire Count army. Included in the box is everything you need to make any one of two different regiments: a warrior regiment with hand weapons and shields or a warrior regiment with spears and shields. The box also includes a plastic command group consisting of a Champion, Musician, and Standard Bearer.



Skeleton Warrior Regiment Box (20)
99120207002

Right: Skeleton Warriors armed with spears and shields.

Below: Skeleton Warriors armed with hand weapons and shields.

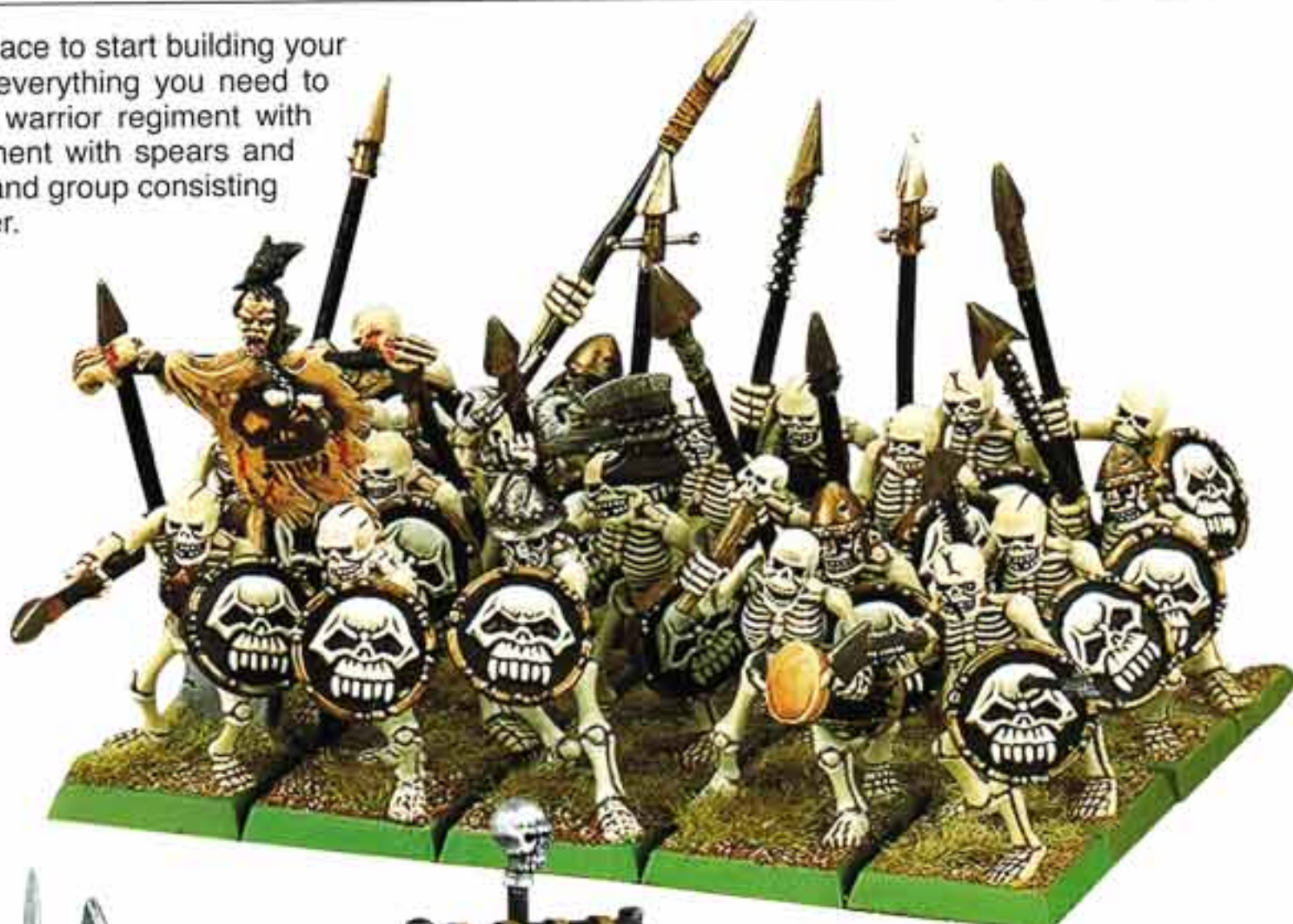

The battlefields of the Old World are strewn with the graves of many nameless warriors who have fallen in combat and been consigned to a hasty resting place or left upon the ground amid the carnage. Even in death, there is no rest for the fallen warriors, for they can be summoned back to the world of the living by black sorcery. All that these once-dead fighters can recall of their mortal life are faint memories of battles fought long ago. All that they feel is the compulsion to fight and to obey their masters.



LORDS & HEROES



Zacharias the Everliving Box (1)
99110207101

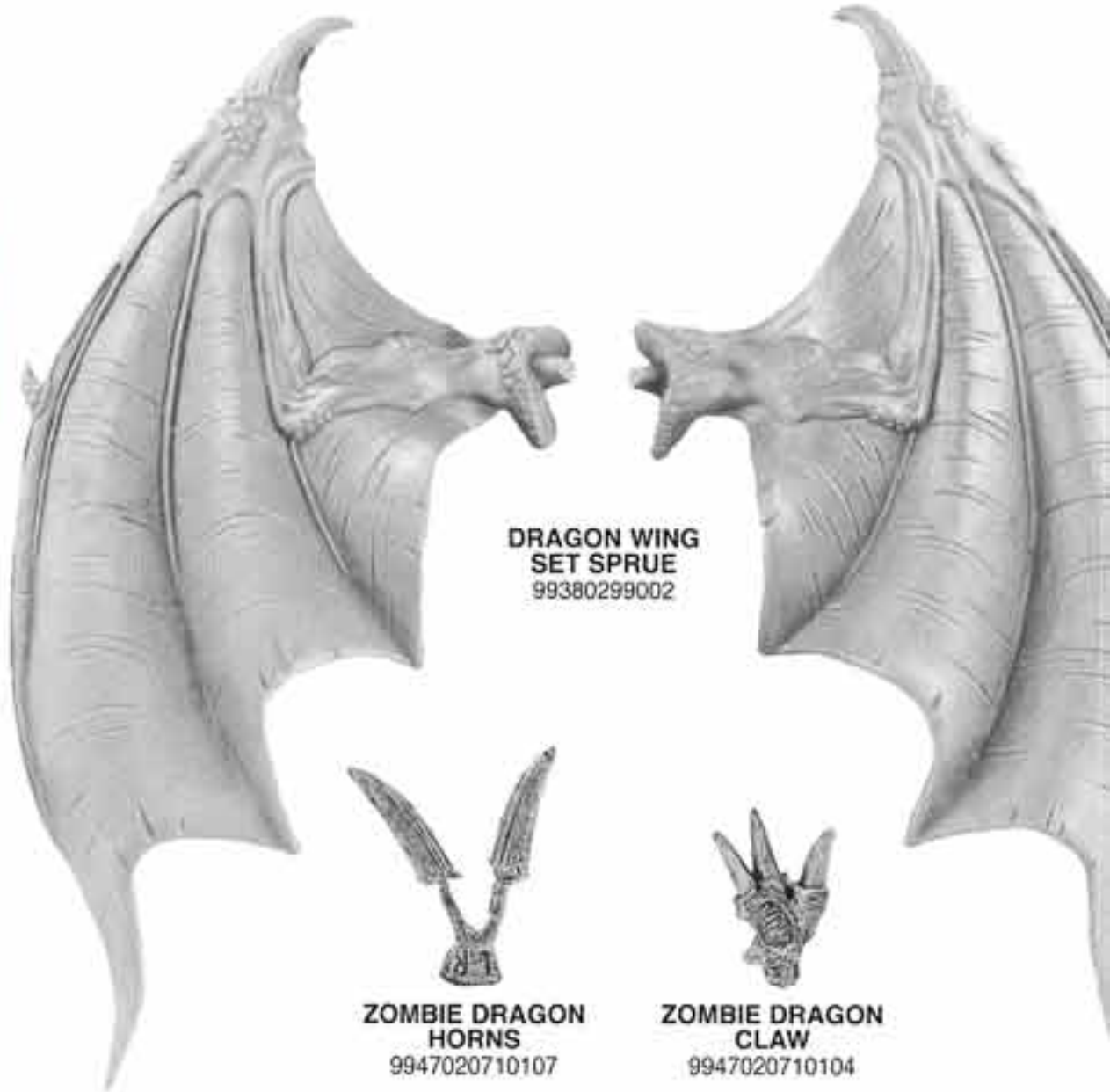

DRAGON WING SET SPRUE
99380299002



ZOMBIE DRAGON HORNS
9947020710107



ZOMBIE DRAGON CLAW
9947020710104



ZOMBIE DRAGON LEFT FOOT
9947020710114



ZOMBIE DRAGON RIGHT ARM
9947020710106



ZOMBIE DRAGON LEFT ARM
9947020710109



ZOMBIE DRAGON LOWER JAW
9947020710108



ZOMBIE DRAGON HEAD & NECK
9947020710105



ZOMBIE DRAGON RIGHT FOOT
9947020710115



ZACHARIAS BAT & BOOK
9947020710113



ZACHARIAS ARM
9947020710103



ZOMBIE DRAGON BODY
9947020710101



ZOMBIE DRAGON TAIL
9947020710102



ZACHARIAS CLOAK
9947020710112



ZACHARIAS BODY
9947020710111



ZACHARIAS HEAD & STAFF
9947020710110

LORDS & HEROES



Wight Army Standard Blister (1)
99060207106



Wight Lord Blister (Random 1)
99060207088



WIGHT CHAMPION SHIELD
9947020708803



WIGHT CHAMPION SWORD ARM
9947020708802



WIGHT LORD STANDARD BODY
9947020710602



WIGHT LORD STANDARD
9947020710601



KRELL BODY
9947020701701



KRELL BANNER POLE
9947020701702



WIGHT CHAMPION
9947020708801

Wights are long dead heroes who are tied to the land of the living by magic. Some Vampires rule over entire regiments of Wights, warriors who dared challenge them in life and now serve them in death.



WIGHT LORD SKELETON STEED LEFT
9947020702903



Mounted Wight Lord Blister (1)
99060207029



WIGHT LORD
9947020702901



WIGHT LORD SHIELD
9947020702902



WIGHT LORD SKELETON STEED RIGHT
9947020702904



LORDS & HEROES



NECROMANCER 1
9947020701001

NECROMANCER 2
9947020701002

NECROMANCER 3
9947079901011

MOUNTED NECROMANCER

Necromancers Blister (1 Mounted & Random 1 on Foot)
99060207090



MOUNTED NECROMANCER LEGS
9947020701202



MOUNTED NECROMANCER BODY
9947020701201



CAPARISON HORSE HEAD SPRUE (RANDOM 1)
99389999012

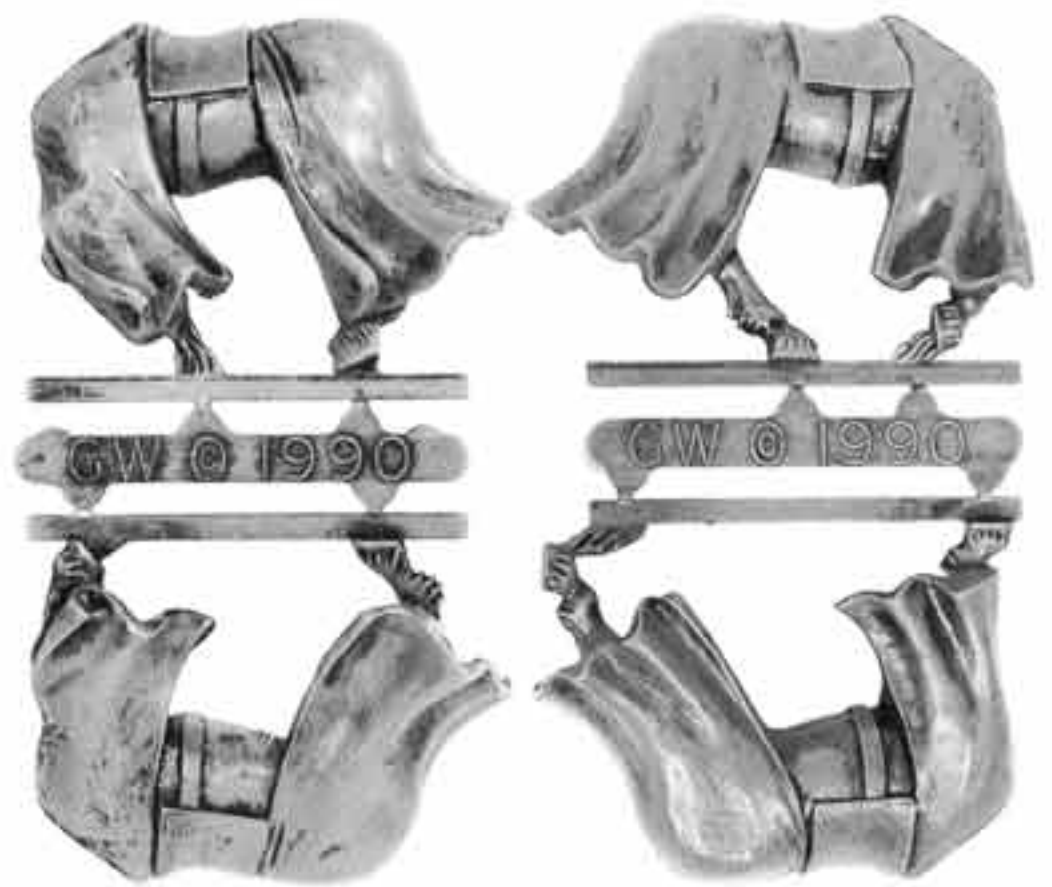

CAPARISON HORSE BODY SPRUE (RANDOM 1)
99389999002



LORDS & HEROES



Wraith Blister (Random 1)
99060207077



WRAITH SCYTHE 1
9947020707705



WRAITH SCYTHE 2
9947020707706



WRAITH 1
9947020707701

WRAITH 2
9947020707702

WRAITH 3
9947020707703

WRAITH 4
9947020707704



Strigoi Vampire Blister (Random 1)
99060207100



STRIGOI VAMPIRE 1
9947020710001

STRIGOI VAMPIRE 2
9947020710003

STRIGOI VAMPIRE 3
9947020710004



STRIGOI VAMPIRE ARM
9947020710002



STRIGOI VAMPIRE HEAD 1
9947020710005



STRIGOI VAMPIRE HEAD 2
9947020710006



STRIGOI VAMPIRE HEAD 3
9947020710007

All miniatures are supplied unpainted. Models, lists, and games are all shown at actual size unless otherwise noted. Contents may vary slightly from those shown.

LORDS & HEROES

PAINTING ZOMBIE FLESH

When flesh is Undead, it takes on a vastly different color (and odor) than living flesh. Therefore, when painting the skin on your Zombies, keep in mind that almost any color can be used. Here are a few examples with greys, purples, browns, and whites. Experiment with other colors to see what putrid looks you can create by mixing paints and inks.



PURPLE SKIN



Step 1. Basecoat the model with a thinned coat of Codex Grey and let it dry. Give the skin a wash of 50/50 Codex Grey and Liche Purple.



Step 2. Use thinned Codex Grey for the first highlights.



Step 3. Add Fortress Grey to the Codex Grey and paint the final highlights.

ROTTING FLESH



Step 1. Paint all the skin with Rotting Flesh and let it dry. Give the skin a wash of a 50/50 mix of Vermin Brown and Dark Angels Green.



Step 2. Paint the first highlights with thinned Rotting Flesh. Aim to keep the highlights subtle.



Step 3. Paint the final highlights with a mix of 50/50 Rotting Flesh and Skull White.



Mannfred Von Carstein Blister (1)
99060207078



MANNFRED VON CARSTEIN SWORD ARM
9947020707802



MANNFRED VON CARSTEIN NIGHTMARE HEAD
9947020707803



MANNFRED VON CARSTEIN
9947020707801



ARMORED HORSE BODY & HEAD SPRUE
(1 HEAD & 1 RANDOM BODY)
99380299004

Von Carstein Vampires include the Armored Horse Body & Head Sprues (99380299004) shown on the opposite page,

LORDS & HEROES



Von Carstein Vampires Blister (Random 1 Set of 1 Mounted & 1 on Foot)
99060207104



VON CARSTEIN 1 ON FOOT
9947020710403



MOUNTED VON CARSTEIN 2 LANCE
9947020710407



VON CARSTEIN 2 ON FOOT
9947020710405



MOUNTED VON CARSTEIN 2 BODY
9947020710404



VON CARSTEIN 2 SWORD
9947020710406



MOUNTED VON CARSTEIN 1 BODY
9947020710401



MOUNTED VON CARSTEIN 1 HEAD
9947020710402



VON CARSTEIN NIGHTMARE HEAD
9947020710408



ARMORED NIGHTMARE TAIL
9947020707003

Lahmian Vampires include the Bretonnian Horse Body Sprue (99389999004) shown with the Nechrarch Vampires.



LAHMIAN VAMPIRE 1 ON FOOT
9947020709801



LAHMIAN VAMPIRE 2 ON FOOT
9947020709803

Lahmian Vampires Blister (1 Random Set of 1 Mounted & 1 on Foot)
99060207098



BRETONNIAN HORSE HEAD SPRUE (SHOWN 50% ACTUAL SIZE)
99389999014



MOUNTED LAHMIAN VAMPIRE W/ STAFF
9947020709804



MOUNTED LAHMIAN VAMPIRE
9947020709802



LAHMIAN VAMPIRE HORSE HEAD
9947020709805



LORDS & HEROES



BLOOD DRAGON 1 SWORD
9947020709903



BLOOD DRAGON 2 SWORD
9947020709905



BLOOD DRAGON 3 SWORD
9947020709909



BLOOD DRAGON 3 SHIELD
9947020709908

Blood Dragon Vampires Blister (Random 1 Set of 1 Mounted & 1 on Foot)
99060207099

Blood Dragon Vampires include the Armored Horse Body & Head Sprues (99380299004) shown with Manfred Von Carstein.



BLOOD DRAGON VAMPIRE HORSE HEAD
9947020709912



MOUNTED BLOOD DRAGON 1
9947020709901



MOUNTED BLOOD DRAGON 2
9947020709904



MOUNTED BLOOD DRAGON 3
9947020709911



BLOOD DRAGON 1 ON FOOT
9947020709902



BLOOD DRAGON 2 ON FOOT
9947020709906



BLOOD DRAGON 3 ON FOOT
9947020709910



BLOOD DRAGON 3 LANCE
9947020709907



LORDS & HEROES



Blood Dragon on Winged Nightmare Box (1)
99110207095



NIGHTMARE RIDER LANCE
9947020709504



NIGHTMARE RIDER SHIELD
9947020709502



NIGHTMARE RIDER HEAD
9947020709503



NIGHTMARE JAW
9947020709512



NIGHTMARE RIDER BODY
9947020709509



NIGHTMARE RIDER CLOAK
9947020709501



NIGHTMARE LEFT LEG
9947020709505



NIGHTMARE RIGHT LEG
9947020709506



NIGHTMARE BODY
9947020709513



NIGHTMARE LEFT ARM
9947020709507



NIGHTMARE RIGHT ARM
9947020709508



NIGHTMARE LEFT WING
9947020709510



NIGHTMARE RIGHT WING
9947020709511



NIGHTMARE HEAD
9947020709514



LORDS & HEROES



Necrarch Vampires include the Armored Nightmare Tail (9947020707003) shown with the Von Carstein Vampires.



NECRARCH FAMILIAR
9947020710208

NECRARCH 1 ON FOOT
9947020710202

NECRARCH 1 MOUNTED

NECRARCH 2 ON FOOT

NECRARCH 2 MOUNTED

Necrarch Vampires Blister (Random 1 Familiar & Random 1 Vampire Set of 1 Mounted & 1 on Foot)
99060207102



NECRARCH NIGHTMARE HEAD
9947020710209



MOUNTED NECRARCH 2 BODY
9947020710203



NECRARCH 2 ON FOOT BODY
9947020710204



MOUNTED NECRARCH 1
9947020710201

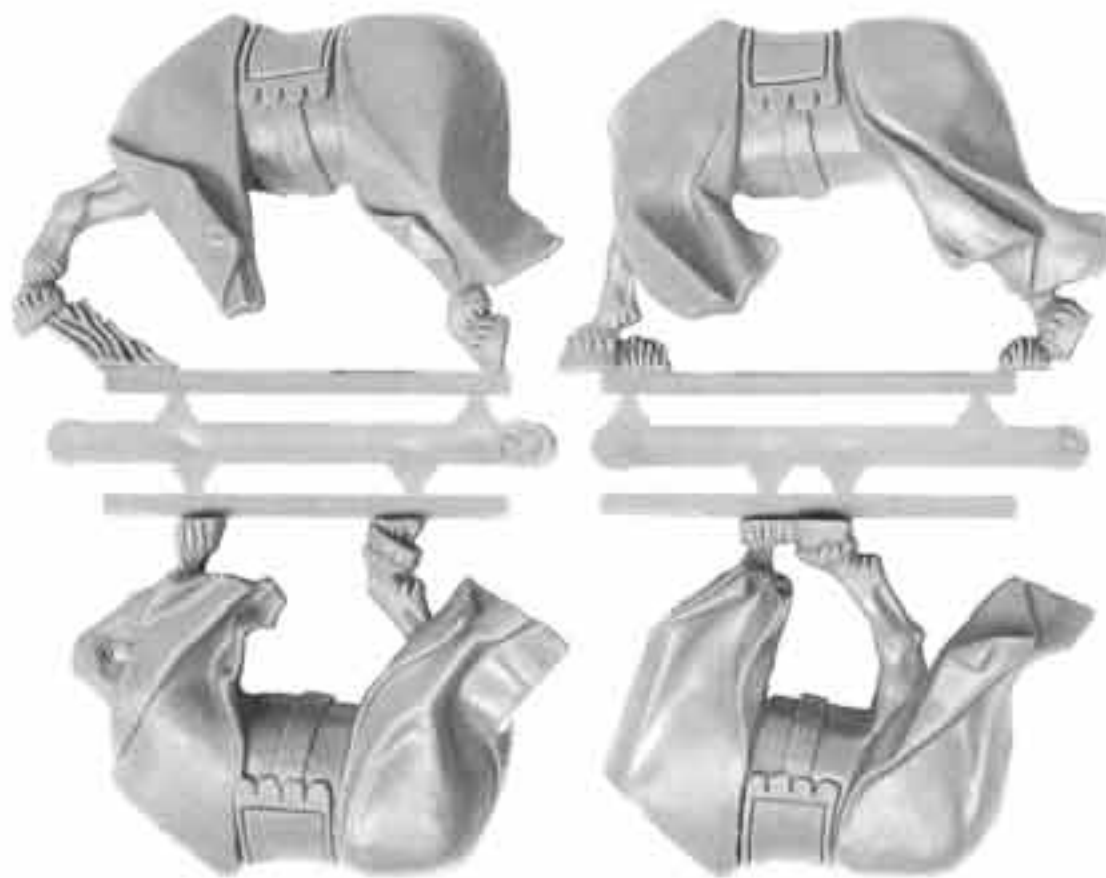
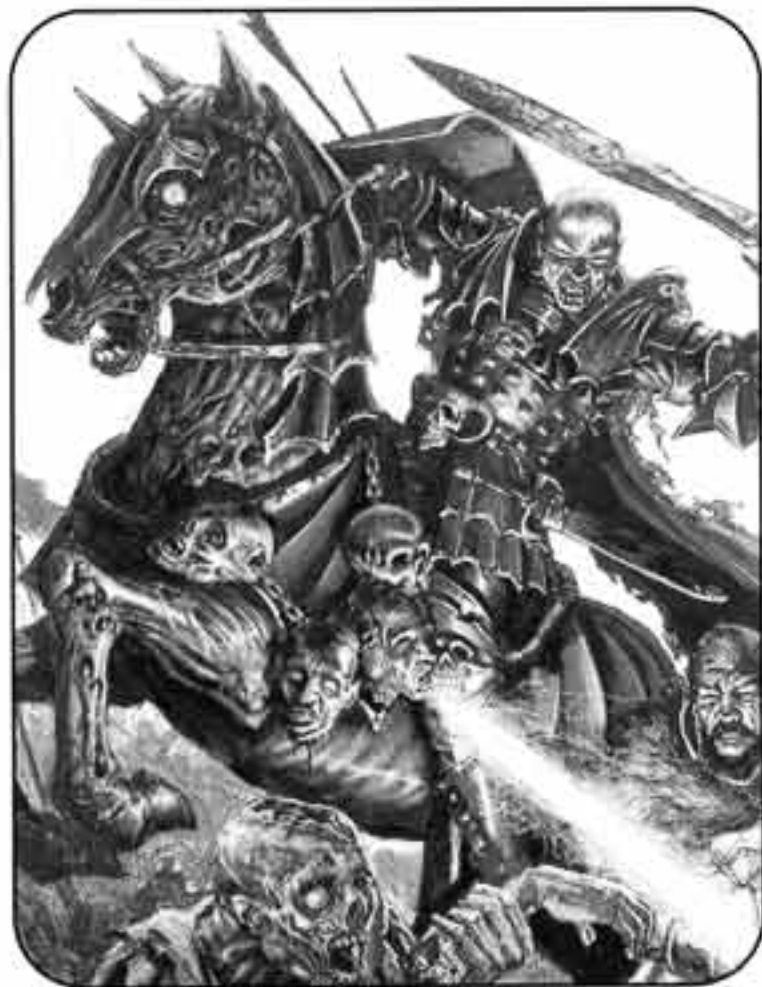

BRETONNIAN HORSE BODY SPRUE
99389999004



NECRARCH 2 HAND
9947020710205



NECRARCH 2 ON FOOT DAGGER
9947020710206



MOUNTED NECRARCH FAMILIAR
9947020710207



CORE UNITS



Skeleton Warrior Regiment Box (20)
99120207002

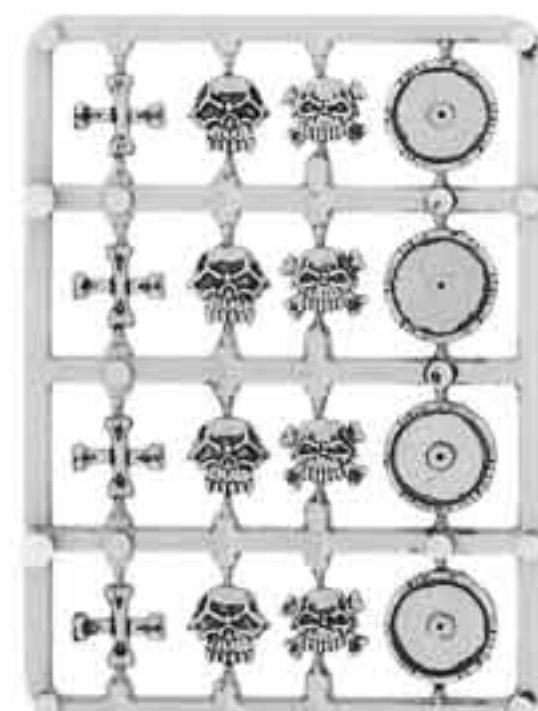

SKELETON WARRIOR SHIELD SPRUE
(SHOWN 70% ACTUAL SIZE)
99360299001

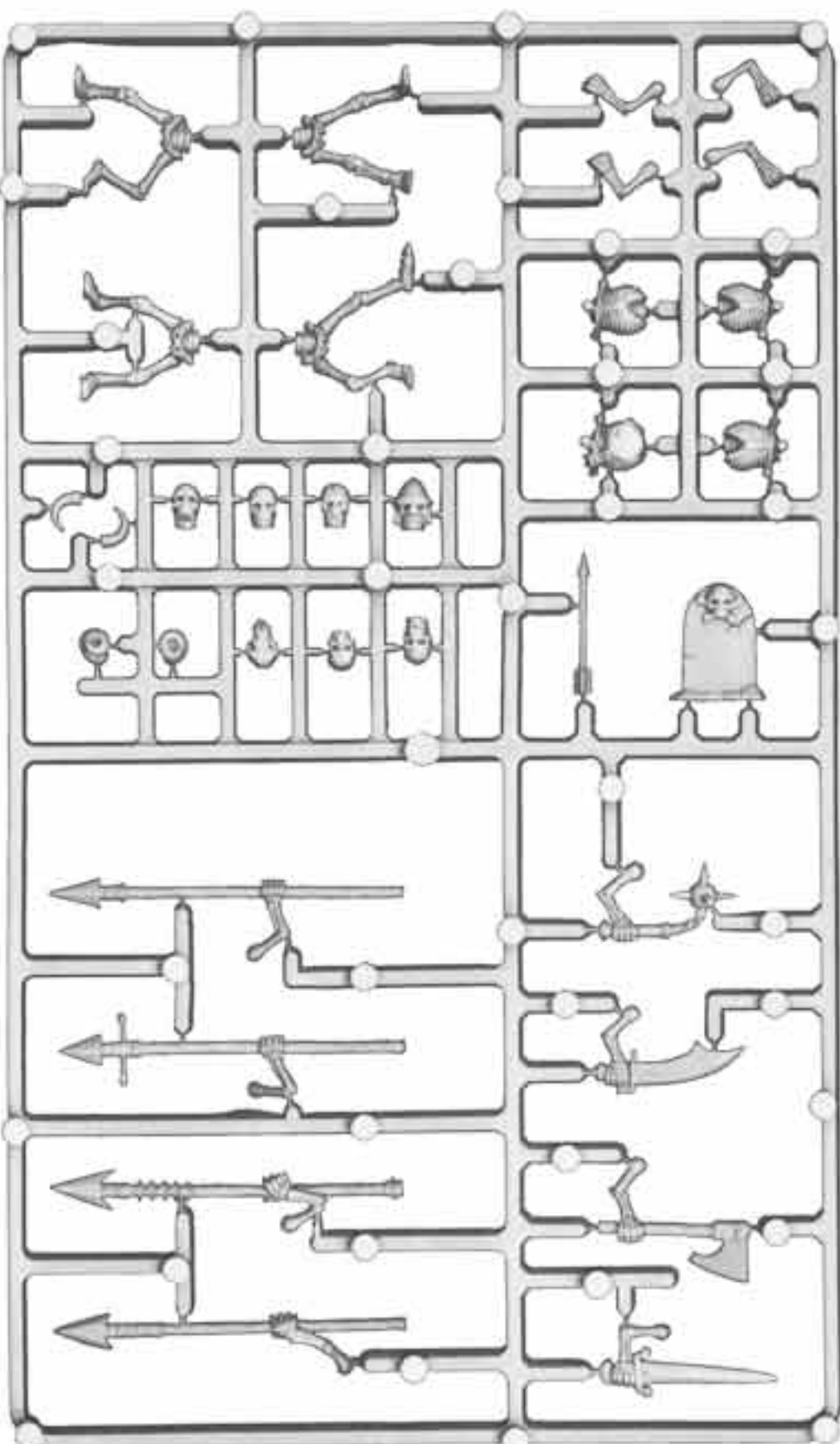

SKELETON WARRIOR SPRUE (SHOWN AT 70% ACTUAL SIZE)
99380207001

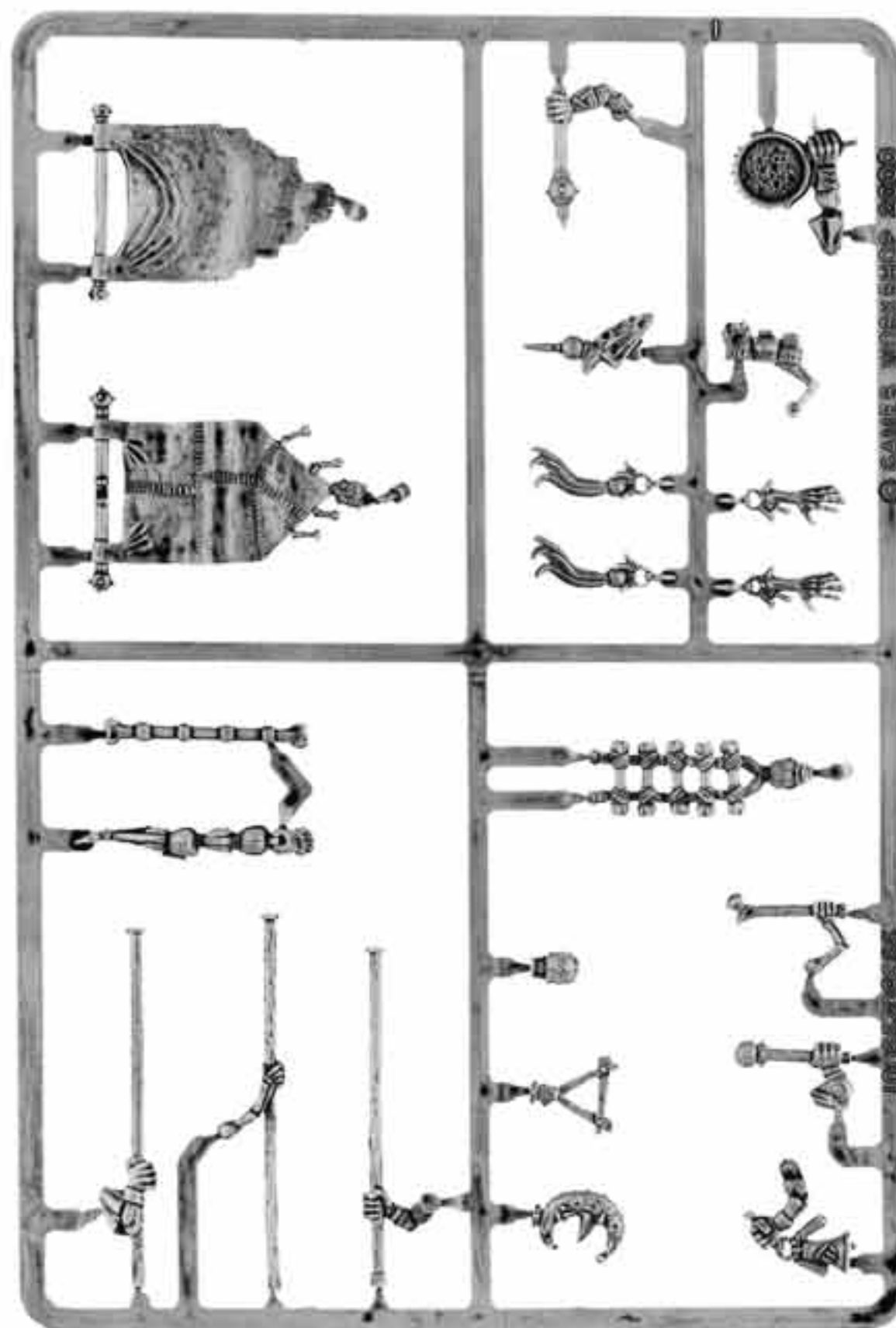

REGIMENT COMMAND SPRUE (SHOWN AT 70% ACTUAL SIZE)
99380299001

All miniature are supplied unpainted. Models, kits, and sprues are all shown actual size unless otherwise noted. Contents may vary slightly from those shown.



CORE UNITS



Zombie Regiment Box (20)
99120207001

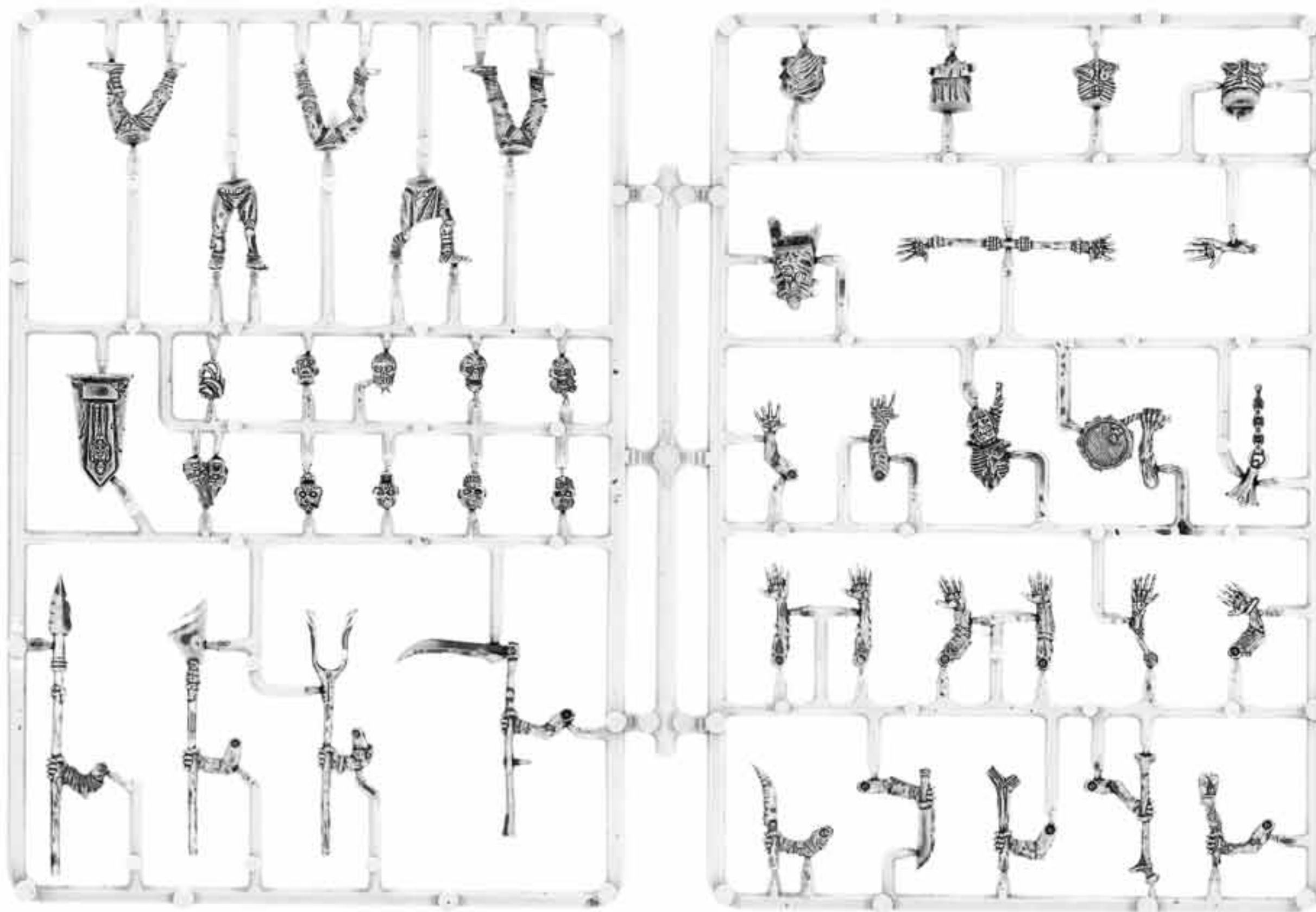

ZOMBIE SPRUE (SHOWN AT 80% ACTUAL SIZE)
99380207002



The Armored Skeleton bitz are only available via Special Offer.



CORE UNITS



Armored Skeletons
Available as Bitz Only



ARMORED SKELETON STANDARD
9947020703801



ARMORED SKELETON MUSICIAN
9947020703802



LARGE SHIELD SPRUE
99369999006



ARMORED SKELETON CHAMPION
9947020703701



ARMORED SKELETON W/ SPEAR 1
9947020703601



ARMORED SKELETON W/ SPEAR 2
9947020703602



ARMORED SKELETON W/ SPEAR 3
9947020703603



ARMORED SKELETON W/ SPEAR 4
9947020703604



ARMORED SKELETON W/ SPEAR 5
9947020703605



Bat Swarm Blister (Random 2 Swarm Bases)
99060207126



BAT 1
9947020703101



BAT 2
9947020703102



BAT 3
9947020703103



BAT 4
9947020703104



BAT 5
9947020703105



CORE UNITS



GHoul 4
9947020706704



GHoul 5
9947020706705



Ghouls Blister (Random 3)
99060207067



GHoul 6
9947020706706



GHoul 8
9947020706708



GHoul 9
9947020706709



GHoul 10
9947020706710



Dire Wolves Blister (Random 2)
99060207075



Doom Wolf Blister (1)
99060207079



DIRE WOLF HEAD 1
9947020707501



DIRE WOLF HEAD 3
9947020707503



DIRE WOLF HEAD 2
9947020707502



WOLF HEAD & BODY SPRUE - RANDOM 1 (SHOWN 70% ACT. SIZE)
99380299005



DOOM WOLF FRONT LEG
9947020707902



DOOM WOLF HIND LEG
9947020707903



DOOM WOLF BODY
9947020707901



CORE UNITS



Fell Bats Blister (Random 2)
99060207105



FELL BAT HEAD 1
9947020710502



FELL BAT HEAD 2
9947020710504



FELL BAT HEAD 3
9947020710506



FELL BAT BODY 1
9947020710501



FELL BAT BODY 2
9947020710503



FELL BAT BODY 3
9947020710505



FELL BAT CONVERSION

To make Fel Bats into even darker creatures that stalk the night and hunger after the blood of the living, Rob Hawkins did a little converting. For a more dynamic pose, Rob added Wyvern wings from our Warmaster range to these already monstrous Fel Bats.

CONVERTING

Cut the wings off a Fel Bat and glue the body to a 40-mm base with a length of wire. Once the glue dries, pin and glue the Warmaster Wyvern wings to the back of the creature.

PUTTY

Fill in any gaps between the wings and the body with putty. Using a sharp tool, texture the putty to blend in with the rest of the model.



BASING

Base the model with sand and other appropriate bits. This model uses plastic tombstones from Mouse Models, a company that makes cemetery models.

PAINTING

Prime the model black and start with a basecoat of Scorched Brown. Highlight the skin and fur with Bestial Brown. Finish with a highlight of Bleached Bone over the fur.





SPECIAL UNITS



Hell Knight Blister (1)
99060207033



Black Knight Blister (Random 1) & Black Knight Command Blister (Random 1)
99060207032 99060207092



MOUNTED WIGHT CHAMPION
9947020703301



MOUNTED WIGHT HORN BLOWER ARM
9947020703502



MOUNTED WIGHT HORN BLOWER BODY
9947020703501



MOUNTED WIGHT STANDARD BODY
9947020703401



MOUNTED WIGHT HELMET WINGS
9947020703402



MOUNTED WIGHT SWORD
9947020702711

The Black Knights include the Skeleton Horse Sprue (99389999007) shown on the opposite page.



MOUNTED WIGHT SPEAR 1
9947020702705



MOUNTED WIGHT STANDARD POLE
9947020703403



MOUNTED WIGHT STANDARD TOP
9947020703404



MOUNTED WIGHT SPEAR 2
9947020702706



MOUNTED WIGHT SPEAR 3
9947020702707



MOUNTED WIGHT BODY 1
9947020702701



MOUNTED WIGHT BODY 2
9947020702702



MOUNTED WIGHT BODY 3
9947020702703



MOUNTED WIGHT BODY 4
9947020702704



MOUNTED WIGHT SHIELD 1
9947020702709



MOUNTED WIGHT SHIELD 2
9947020702710

MOUNTED WIGHT SPEAR 4
9947020702708



SPECIAL UNITS

PAINTING SPIRIT HOSTS

Some say that spirits are white, while others describe them appearing in many different shades. Try these haunting schemes to liven up your spirits.

SHADOW GREY UNDERTONE



Step 1. Prime the models with Skull White and paint them with Shadow Grey.

Step 2. Drybrush the entire model with Codex Grey.



Step 3. Highlight with a drybrush of Fortress Grey.

Step 4. Finish with a light drybrush of Skull White.



GREY UNDERTONE



Step 1. Prime the models with Skull White and paint them with Shadow Grey.

Step 2. Drybrush the entire model with Codex Grey.

Step 3. Highlight with a drybrush of Fortress Grey.



SKELETON HORSE SPRUE (RANDOM 1)
99389999007

The dead do not rest easy in the Old World. Ghosts, shades, and specters of dead men return to haunt the land of the living. Some Vampires and the most twisted of Necromancers hold the knowledge to summon these miserable creatures and unleash them upon their enemies. When summoned, spirits gather together into vast hosts and advance on the enemy. They are silent and incorporeal but no less frightening, because their touch is enough to freeze the hearts of mortals.



Ethereal Host Blister (3)
99060207071



SPIRIT HOST 1
9947020707101



SPIRIT HOST 3
9947020707103



SPIRIT HOST 2
9947020707102



SPECIAL UNITS



Grave Guard Regiment Box (10) & Grave Guard Command Blister (3)
99110207096 99060207103



GRAVE GUARD CHAMPION
9947020710303



GRAVE GUARD SHIELD
9947020710304



GRAVE GUARD STANDARD
9947020710302



FIGHTER SHIELD SPRUE
99369999003



GRAVE GUARD STANDARD BEARER
9947020710301



GRAVE GUARD HORN BLOWER
9947020710305



GRAVE GUARD 1
9947020709601

RARE UNITS



BANSHEE 1
9947020703001

BANSHEE 2
9947020703002

BANSHEE 3
9947020703003

Banshee Blister (Random 1)
99060207030



GRAVE GUARD 2
9947020709602



GRAVE GUARD 3
9947020709603



GRAVE GUARD 4
9947020709604

The Black Coach includes the Skeleton Horse sprue (99389999007) shown in the special Units section.



RARE UNITS



BLACK COACH CUSHION
9947020706812



BLACK COACH AXLE
9947020706806



BLACK COACH BANNER POLE
9947020706807



Black Coach Box (1)
99110207068



7-SPOKED WHEEL SPRUE
99399999001



BLACK COACH STEED'S PLUME
9947020706810



BLACK COACH SEAT
9947020706811



BLACK COACH WRAITH LEGS
9947020706813



BLACK COACH SIDE 1 (LEFT)
9947020706804



BLACK COACH WRAITH BODY
9947020706814



BLACK COACH YOKE
9947020706815



BLACK COACH SIDE 2 (RIGHT)
9947020706805



BLACK COACH BELL
9947020706808



BLACK COACH BRAZIER
9947020706809

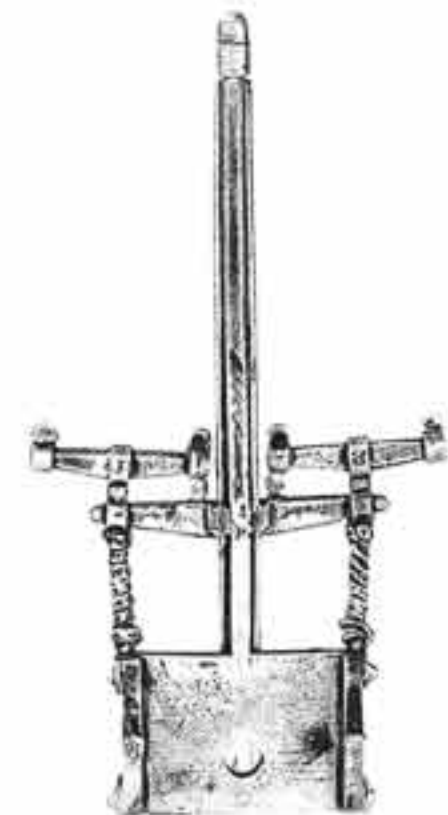

BLACK COACH AXLE & HAFT
9947020706802



BLACK COACH FLOOR
9947020706801



BLACK COACH ROOF
9947020706803



BLACK COACH COFFIN
9947020706816



BLACK COACH COFFIN LID
9947020706817



COLORS OF WAR



KEY

■ Top Box(es): Basecoat Colors & Ink Washes

■ Bottom Box(es): Highlights

■ Mixed Colors

Shields (Right and Below): Giving every model in a unit the same shield design is an easy and effective way to make the regiment look like a distinct whole. This effect will be heightened if you use the same colors on both the shields as well as the banner.



Skull White, Chestnut Ink
Skull White drybrush



Skull White
Black Ink



Chaos Black
Bleached Bone drybrush



Bestial Brown
Bleached Bone drybrush



Skull White
Brown Ink



Skull White, Brown Ink
Bleached Bone drybrush



Skull White
Chestnut Ink



Skull White, Chestnut Ink
Bleached Bone drybrush

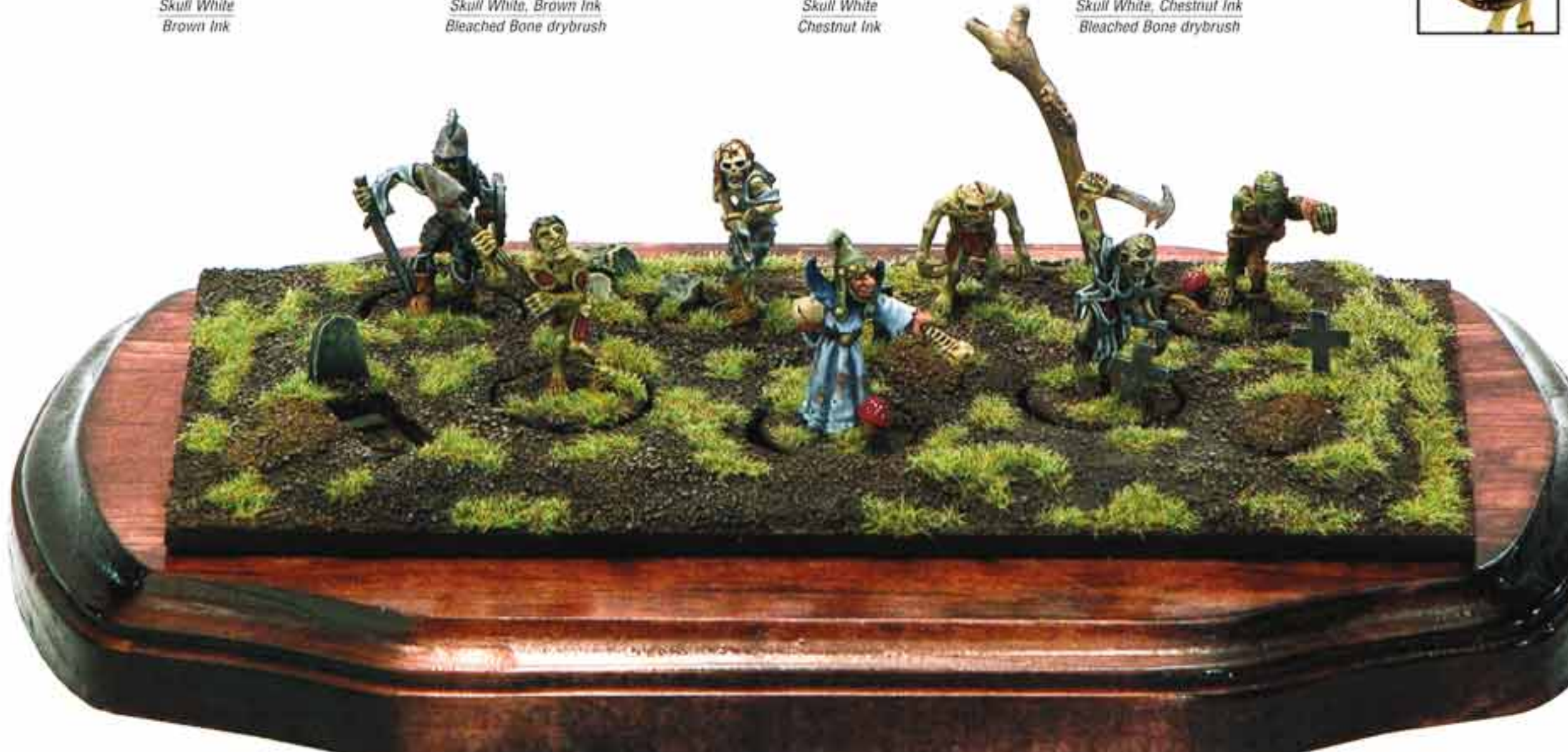

Erik "Kep" Pump's Necromancer and Zombies won third place at the 2004 Atlanta Golden Demon painting competition.

TACTICS

TIPS FOR WINNING WITH VAMPIRE COUNTS



- A. A Von Carstein Vampire Thrall with a great weapon, the Wolf Form bloodline power, and the Flayed Hauberk can lead a unit of Dire Wolves as an extremely potent champion. This character is deadly in challenges and excellent against Chariots or Monsters. He and the unit are both very maneuverable.
- B. A Strigoi Vampire with the Bat Form bloodline power can accompany (but not join) a unit of Fell Bats to create an extremely potent flying fighting force. These models can move around the battlefield very quickly and bring a large number of Attacks to bear on nearly any unit you choose.
- C. A Blood Dragon Vampire Lord mounted on a Zombie Dragon with the Cursed Book and the Blademaster bloodline power can be a terrifying opponent in combat. He is extremely difficult to hit (-2 to hit rolls, -1 Attack to one enemy model), much less hurt. Add in the Zombie Dragon's fighting ability and the Vampire Lord's own Attacks, and you have one very impressive Lord character.

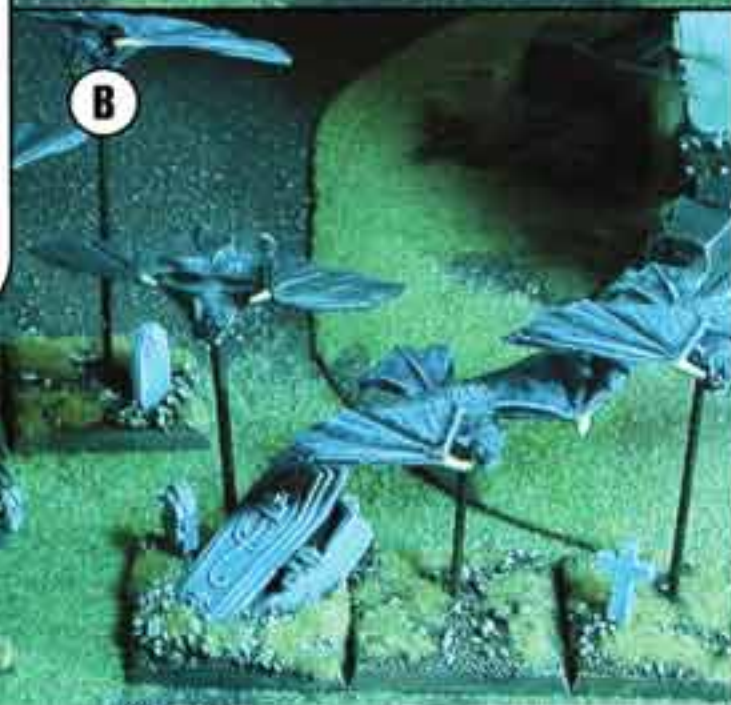

COUNTERTACTICS

TIPS FOR FIGHTING AGAINST VAMPIRE COUNTS

- A. This character can be problematic, but this unit is rather vulnerable to shooting. A reasonably strong unit can charge the Dire Wolves and take them out with combat resolution. Alternatively, send in a Hero with a weapon that ignores armor saves to remove the Thrall before he can swing.
- B. This combination is very powerful but vulnerable as well. Since the Strigoi is not part of the Fell Bat unit, he will suffer Wounds if the Undead are beaten in combat.
- C. Although this model is difficult to kill, it's very much an "all the eggs in one basket" approach. Once you slay the General, the rest of the army crumbles very quickly! Target this character with war machines, particularly Cannons, to remove the threat.

SHOWCASE



Above: A conversion from Jason Meyer's 2003 Minneapolis Grand Tournament army



Above: Anne Foerester won second place at the 2002 Canadian Games Day Golden Demon.

Check out other sections of the catalog for more conversion ideas for completing your Armored Skeleton unit.



ALTERNATE MODEL – CORE Armored Skeletons

COMPONENTS

- 99380207002 Zombie Sprue
- 99380203002 Bretonnian Men-at-Arms Sprue
- 9947020708301 Coffin Shield Sprue

COMPLEXITY RATING



ORDERING INFORMATION

Armored Skeletons Conversion (4)
12345678901



THIS CONVERSION CONTAINS THE SPECIAL OFFER BITZ SHOWN HERE

See the catalog introduction for more information.



COFFIN SHIELD SPRUE
9947020708301

ALTERNATE MODEL – SPECIAL Black Knights

COMPONENTS

- 99369999003 Fighter Shield Sprue
- 99389999002 Caparison Horse Body
- 99390202003 Empire Knights Sprue
- 9947020708001 Skeleton Champion Head
- 9947020710209 Necrarch Nightmare Head
- 9947110100908 Plague Cart Horse Head

COMPLEXITY RATING



ORDERING INFORMATION

Black Knight Conversion (1)
12345678901



THIS CONVERSION CONTAINS THE SPECIAL OFFER BITZ SHOWN HERE

See the catalog introduction for more information.



SKELETON CHAMPION HEAD
9947020708001

SHOWCASE

Left: Greg Smalling's Von Carstein Standard Bearer won second place at the 2004 Atlanta Golden Demon painting competition.



Left: This model from Eric Hagen's army helped him to win the Player's Choice award at the 2003 Minneapolis Grand Tournament.



Above: Vampire Lord Antoine Von Carstein was converted by Mark Harrison and painted by Joe Hill.



Above & Left: Chad Mierzwa's bizarre scarecrow conversions

Right: Thomas Haslup's Zombie Regiment won third place at the 2004 Baltimore Golden Demon painting competition.



WOOD ELVES

The Dwarfs marched in good order down the recently cleared forest road. Although no enemy had been seen in the area, the Dwarfs regarded everything but their own tunnels as potentially dangerous. Thus, the rugged mountain folk were always ready for battle. It was essential for the new mining colony to establish a good logging camp, and this road cut into the very center of the forest would supply fuel, timber, crossbeams, and more.

Singing harshly in their own gruff language, the Dwarfs passed within arm's length of the Wood Elf archers. As the column of troops passed a prearranged part of the road, the forest air hummed with sounds of released bowstrings. Arrows whistled from the undergrowth and seemed to sprout out of the Dwarfs' bodies. The missiles stuck into chests, protruded from beards, and even pierced through helmets. Grasping the arrows in amazement as their life-blood ran out of them, many Dwarfs dropped to the ground. The battle for the forest was begun, and already half of the Dwarfs had fallen.

Wood Elves are a rustic and secretive race that dwell for the most part in the Loren forest. Throughout the Old World there are additional enclaves of Wood Elves, always centered around large forests. Strangers or intruders are not welcomed into these sylvan kingdoms, and unwary travelers who wander past the often unmarked boundaries are likely to be met with a hail of arrows.

Fighting Style

The Wood Elves have mastered the art of the hit-and-run attack. As the entire army may discount any penalties for moving in a forest, a standard Wood Elf tactic is to harass encroaching enemies with missile fire, and then as the foe closes, the sylvan folk fade back into the safety of dense terrain. A tactical Wood Elf commander can use several units to provide enfilading fire against an enemy, while the Elves prepare to scamper further into the woods if they are threatened. Just when an enemy is whittled down and confused, the Elves launch a fierce charge by hard-hitting specialty units like Warhawk Riders, Wardancers, Dryads, and Treemen.

Collecting a Wood Elf Army

The place to start with any new army is a few Core selections. Not only are such units a minimal requirement for the army, but they can form the center for any larger force you choose to build. For Wood Elves, it is hard to pass up Glade Guard. With a Ballistic Skill of 4 and a special rule that enables them to fire

Ben Bishop won the Slayer Sword at the 2004 Chicago Games Day Golden Demon painting competition with this Ariel model.



their longbows at Strength 4 at short range, Wood Elf Glade Guard are easily among the most feared missile troops in the game. Other Core choices are Glade Riders (Wood Elf cavalry), Eternal Guard, and Dryads.

After a Wood Elf commander has painted a few Core units, it is time for him to look at a few of the more exotic choices. Wardancers are not only colorful and fun to paint but have a variety of excellent close combat special abilities. Warhawk Riders are like cavalry but have the ability to fly. Scouts are excellent at slowing down the enemy. Waywatchers are equally talented small bands of archers, but they are even more experienced at using the



woods to set ambushes. The Wild Riders of Kurnous are the personal guards of Orion, Lord of the Forest. These riders are *Fast Cavalry* and have several special rules that make them a force to be reckoned with on the battlefield. Treemen and Tree Kin are powerful creatures of the forest that are vast in Strength and Toughness. Continuing the nature theme, Great Eagles can also be called upon to aid a Wood Elf army.



Wood Elf Battalion Box
99120204005

- 24 Glade Guard
- 12 Dryads
- 8 Glade Riders



GETTING STARTED



This 80-page rulebook contains painting and modeling guides, background, and the full rules for fielding an army of mysterious and deadly Wood Elves.

**Warhammer Armies:
Wood Elves**
60030204002



LORDS & HEROES



MOUNTED LORD BODY
9947020406801



LORD HORSE HEAD
9947020406804



MOUNTED LORD ARMS
9947020406803



MOUNTED LORD SPRUE
9947020406802



Mounted Lord Blister (1)
99060204068



WOOD ELF STEED SPRUE (RANDOM 1)
99380299010





LODS & HEROES



SPELLSINGER 1



SPELLSINGER 2



Wardancer Lord Blister (1)
99060204071
BIT NAME: WARDANCER LORD
BIT CODE: 9947020406602



SPELLSINGER 3
9947020406503



SPELLSINGER 4
9947020406504



Waywatcher Lord Blister (1)
99060204072



WAYWATCHER LORD
9947020406603

Spellsingers Blister (Random 1)
99060204065



SPELLSINGER 2
9947020406502



SPELLSINGER 1
9947020406501



Lord w/ Great Weapon Blister (1)
99060204073



LORD W/ GREAT WEAPON
9947020406601

LORDS & HEROES



ORION BODY
9947020405701



ORION RACK
9947020405702



ORION CLOAK
9947020405705



ORION HORN
9947020405703



ORION SPEAR
9947020405704



Orion Box (1)
99110204057



ORION QUIVER
9947020405706



ORION HOUND 1
9947020405707



ORION HOUND 2
9947020405708



Branchwraith Drycha Blister (1)
99060204062



DRYCHA BODY
9947020406201



DRYCHA ARM
9947020406202





LORDS & HEROES



Sisters of Twilight on Forest Dragon Box (1)
99110204054



DRAGON HEAD
9947020405401



DRAGON SPRUE
9947020405409



DRAGON TAIL
9947020405408



DRAGON NECK
9947020405403



DRAGON RIGHT LEG
9947020405407



DRAGON LEFT LEG
9947020405410



DRAGON BODY
9947020405404



DRAGON RIGHT CLAW
9947020405405



DRAGON LEFT CLAW
9947020405406



DRAGON TAIL END
9947020405411

All miniatures are supplied unpainted. Models, lists, and prices are all shown actual size unless otherwise noted. Contents may vary slightly from those shown.



LORDS & HEROES



DRAGON WING SPRUE
99380299002



DRAGON BASE
9947020405412



SISTER OF TWILIGHT 1
9947020405413



SISTER OF TWILIGHT 2
9947020405414



SISTER SPRUE 1
9947020405415



SISTER SPRUE 2
9947020405416



CLOAK CAMOUFLAGE

Since Wood Elves are a force that specializes in ambushes and surprise attacks, you may want to paint camouflage patterns on your models. Here are a few pointers.

PAINTED PATTERNS

Some Wood Elf models already have leaves and foliage sculpted as part of their cloaks and other details. Cloaks that have a few leaves on them are a good place to add freehand painted leaves.

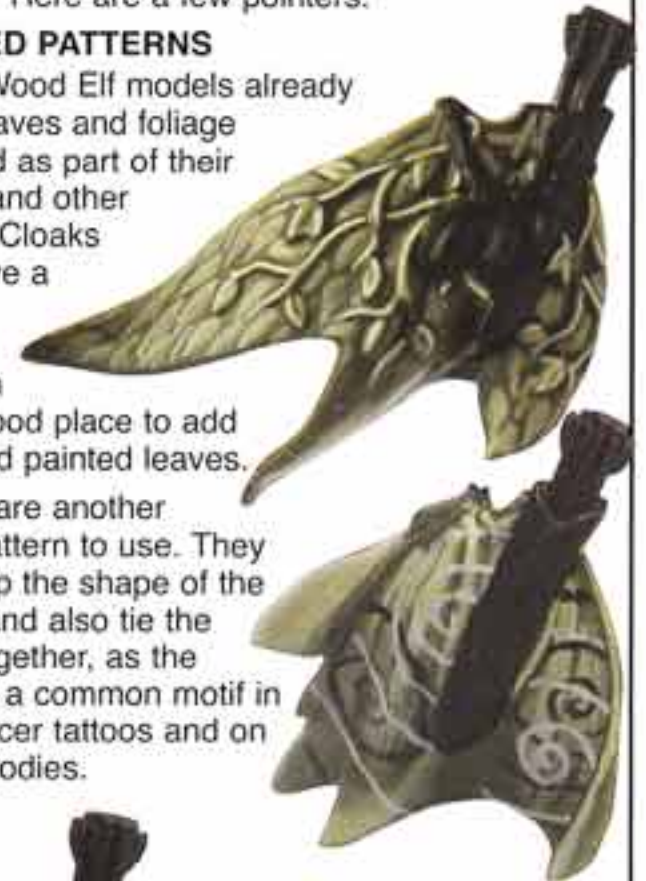

Spirals are another good pattern to use. They break up the shape of the model and also tie the army together, as the spiral is a common motif in Wardancer tattoos and on Dryad bodies.

WASHES

Use washes to make random shapes that you will then detail further in later stages. For instance, paint the cloak Camo Green and then wash with thinned Green Ink. Paint Brown Ink stripes and then detail them further to suggest bark or woodgrain.



STIPLING & SPLATTERING

To make small and random areas of color, try stippling and splattering. To make a snow cloak, use an old drybrush whose bristles have fanned out over time. Instead of painting by drawing the brush across the model, use a quick, repeated stabbing motion to paint the model. You can use a similar "splattered paint" technique to create an autumn cloak like the one shown here. Use an old toothbrush to splatter the paint onto the model. When splatter painting, mask off other parts of the model to prevent them from being splattered or simply start with the cloak.



CORE UNITS



Glade Guard Regiment Box (16)
99120204002

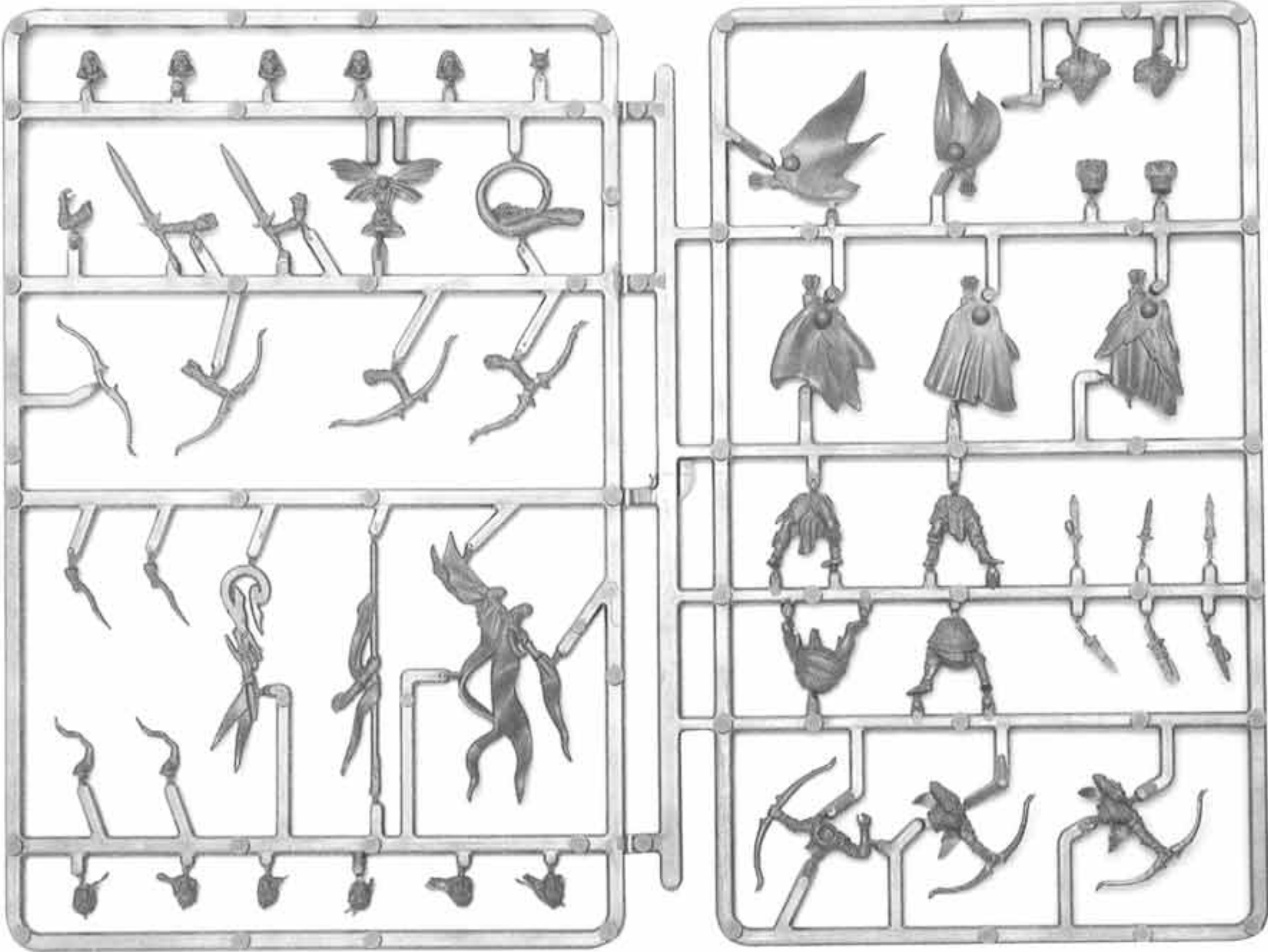

GLADE GUARD SPRUE (SHOWN 75% ACTUAL SIZE)
99380204001



The Glade Riders also come with the Elven Steed Sprue (99380299010) shown previously.



CORE UNITS



Glade Riders Regiment Box (8)
99120204004

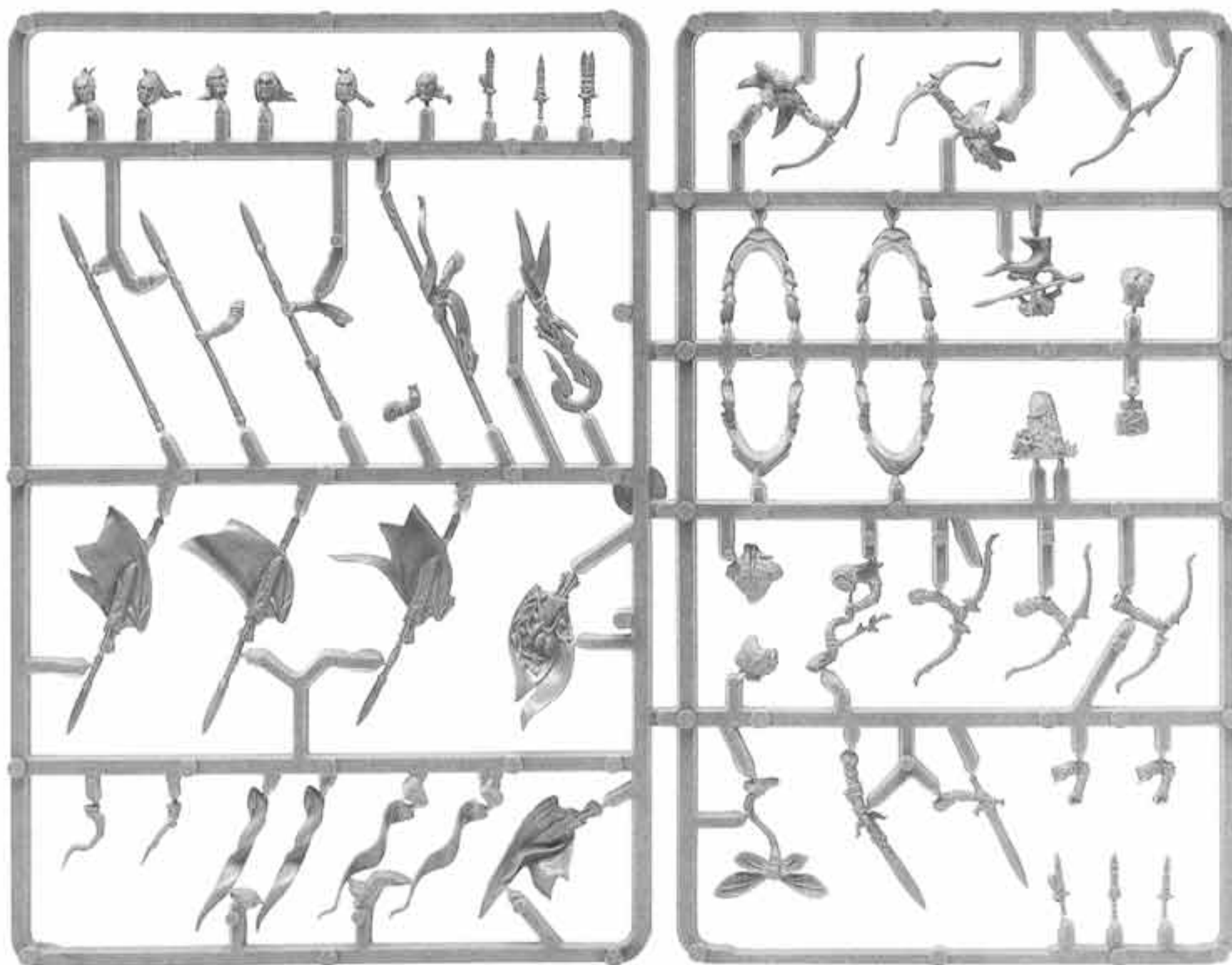

GLADE RIDERS SPRUE (SHOWN 60% ACTUAL SIZE)
99380204003



CORE UNITS



Dryads Box (12)
99120204003

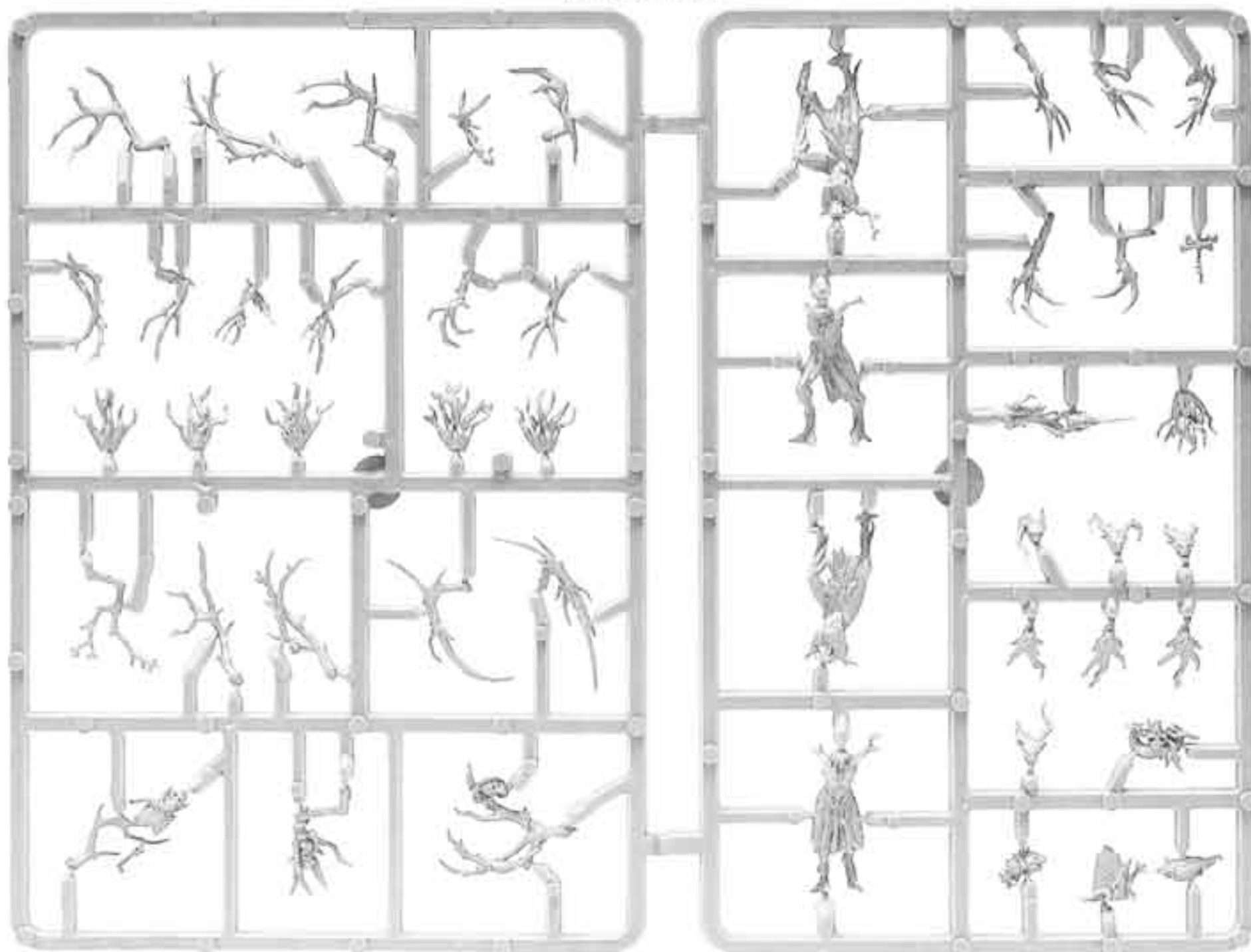

DRYAD SPRUE (SHOWN 60% ACTUAL SIZE)
99830204002



CORE UNITS



Eternal Guard Box (10)
99110204055



ETERNAL GUARD 1
9947020405501



ETERNAL GUARD 2
9947020405502



ETERNAL GUARD 3
9947020405503



ETERNAL GUARD 4
9947020405504



ETERNAL GUARD 5
9947020405505



ETERNAL GUARD 6
9947020405506



ETERNAL GUARD CHAMPION 1
9947020407001



ETERNAL GUARD CHAMPION 2
9947020407002



ETERNAL GUARD MUSICIAN
9947020407005



ETERNAL GUARD STANDARD BEARER

Eternal Guard Command Blister (Random 3)
99060204070



ETERNAL GUARD STANDARD BEARER
9947020407003



ETERNAL GUARD STANDARD
9947020407004



SPECIAL UNITS



Wardancers Box (10) & Wardancers Command Blister (Random 2)
99110204059 99060204069



WARDANCER CHAMPION 1
9947020406901



WARDANCER CHAMPION 2
9947020406902



WARDANCER MUSICIAN
9947020406903



WARDANCER 1
9947020405901



WARDANCER 2
9947020405902



WARDANCER 3
9947020405903



WARDANCER 4
9947020405904



WARDANCER 5
9947020405905



SPECIAL UNITS



Warhawk Rider Blister (Random 1)
99060204064



WARHAWK 1 RIDER
9947020406404



WARHAWK 2 RIDER
9947020406412



WARHAWK ACC'Y. SPRUE
9947020406416



WARHAWK 2 RIDER SPRUE
9947020406413



WARHAWK 1 SPRUE
9947020406402



WARHAWK 2 SPRUE
9947020406414



WARHAWK 1 WINGS
9947020406403



WARHAWK 2 WINGS
9947020406415

PAINTING FEATHERS

There are all sorts of ways to paint feathers. Below are some quick techniques that will allow you to get your Great Eagles and Warhawk Riders onto the tabletop in no time.

DARK BROWN

Over an undercoat of Chaos Black Spray Primer, drybrush with Scorched Brown. Next, drybrush more lightly with Bestial Brown and then Bleached Bone.



LIGHT BROWN

Over a Chaos Black undercoat, paint the model Codex Grey. Next, apply a thinned-down wash of Black Ink. Finish the feathered areas by drybrushing with Fortress Grey and then more lightly with Bleached Bone only on the outer edge.



DARK GREY

Paint a basecoat of Bubonic Brown over a Skull White spray undercoat. Wash the feathered areas with with thinned-down Flesh Wash. Once the wash dries, drybrush lightly with Bleached Bone.



LIGHT GREY

Prime the model with Skull White spray and then apply a basecoat of Shadow Grey. Drybrush with Space Wolves Grey and then with Skull White. Finally, apply a very light drybrush of Bleached Bone to bring a little warmth to the colors.





SPECIAL UNITS

CONVERTING TREEMEN AND TREE KIN

Various parts from a number of ranges were used in the construction of these Treemen. The fat Treeman uses the torso of the Great Unclean One, while the skinny Treeman uses Durthu's torso and the Blood Bowl Treeman's hips. Both use legs from Durthu and Warmaster Carrion bitz for branches.

Test fit the pieces before you glue anything. You'll need to do some sanding and shaping for the pieces to fit together well. Pin the pieces together.



Add a few more details like the larger branch, which was originally the club from the Albion Giant, and the crow from the Nurgle Lord's signpost. Use green stuff to fill gaps and create smooth transitions from piece to piece.



The Treemen created in this way are great for representing Treeman Ancients. Similar techniques can be used to make alternate Treekin and Branchwraiths. Just scale the figure down to the appropriate size.



Tree Kin Blister (Random 1)
99060204061



TREE KIN 1 BODY
9947020406101



TREE KIN 1 SPRUE
9947020406102



TREE KIN 1 ARM
9947020406103



TREE KIN 2 BODY
9947020406104



TREE KIN 2 LEGS
9947020406105



TREE KIN 2 ARM 1
9947020406106



TREE KIN 2 ARM 2
9947020406107



TREE KIN 3 BODY
9947020406108



TREE KIN 3 SPRUE
9947020406109



TREE KIN 3 ARM 2
9947020406111



SPECIAL UNITS

The Champion, Musician, and Standard Bearer bits are available only in the boxed regiment. They are not part of the random assortment for the Wild Riders blister packs.

The Wild Riders also come with the Elven Steed Sprue (99380299010) shown previously.



Wild Riders Box (5) & Wild Riders Blister (Random 1)
 99110204058 99060204067

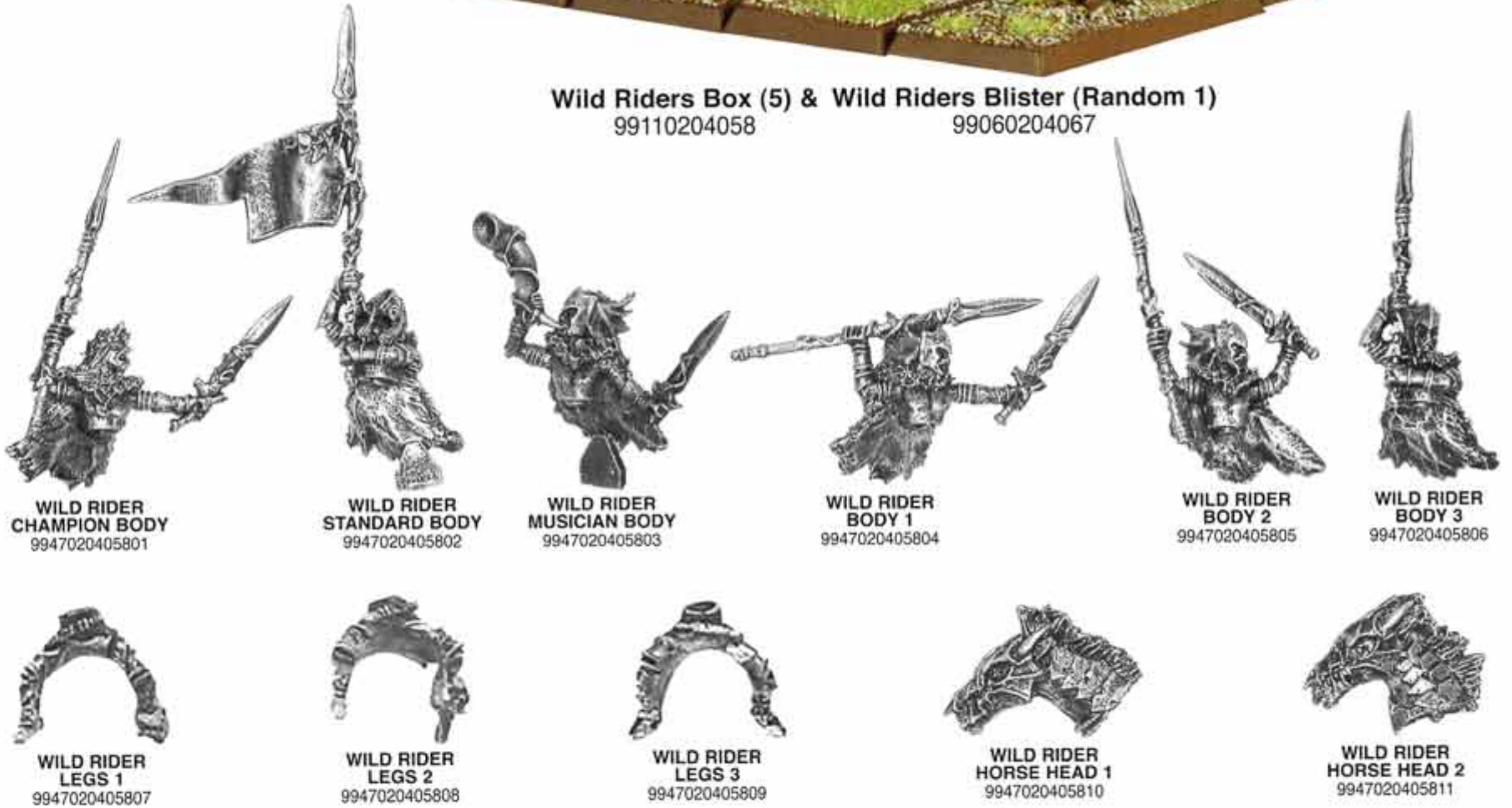

WILD RIDER CHAMPION BODY
 9947020405801

WILD RIDER STANDARD BODY
 9947020405802

WILD RIDER MUSICIAN BODY
 9947020405803

WILD RIDER BODY 1
 9947020405804

WILD RIDER BODY 2
 9947020405805

WILD RIDER BODY 3
 9947020405806

WILD RIDER LEGS 1
 9947020405807

WILD RIDER LEGS 2
 9947020405808

WILD RIDER LEGS 3
 9947020405809

WILD RIDER HORSE HEAD 1
 9947020405810

WILD RIDER HORSE HEAD 2
 9947020405811





RARE UNITS



TREEMAN HEAD
9947020405601



Treeman Box (1)
99110204056



TREEMAN BODY
9947020405602



TREEMAN LEG 1
9947020405603



TREEMAN SPRUE 1
9947020405604



TREEMAN LEG 2
9947020405605



TREEMAN SPRUE 2
9947020405606



WAYWATCHER 1
9947020406001



WAYWATCHER 2
9947020406002



WAYWATCHER 3
9947020406003



WAYWATCHER 4
9947020406004



WAYWATCHER 5
9947020406005

Waywatchers Blister (Random 3)
99060204060

TACTICS



TIPS FOR WINNING WITH WOOD ELVES

- A. With almost every unit in the army being *Skirmishers*, *Fast Cavalry*, or *Flyers*, the Wood Elves are easily the most maneuverable army in the game of Warhammer. Players that have a strong command of these three troop types will be able to run circles around their opponents. Avoid combat when it does not suit you, surround your enemy, and spring trap after trap to defeat armies that are larger and tougher.
- B. It's possible to field an entire army of nothing but Treemen, Dryads, and Tree Kin. While this all-Tree army will be few in numbers, very few opponents will expect to face an army of close combat monsters when preparing to do battle with Wood Elves. The element of surprise is your ally here. Move quickly to engage the enemy in combat before he has a chance to adjust his formations to face your combat-oriented force.
- C. With high maneuverability, the Wood Elves are great at slowing down the enemy to give their accurate missile troops time to take their toll on the enemy. Use *Scouts*, *Skirmishers*, *Fast Cavalry*, and other maneuverable troops to stay within 8" of enemy troops, prevent them from March moving, and fire away.



COUNTERTACTICS

TIPS FOR FIGHTING AGAINST WOOD ELVES

- A. One of the Wood Elves strengths, the high number of *Skirmishing* units, can also be one of their greatest weaknesses. If you can catch these units with a block of infantry or some hard cavalry, their lack of a rank bonus will almost ensure their defeat in combat. However, beware of traps! Catching one small unit can result in being surrounded by three others – not a good trade-off.
- B. If a Wood Elf player surprises you with an all-Tree army, do your best to take advantage of the army's weaknesses. The all-Tree army will have few numbers. Try to gang up on small units and lone Treemen with powerful characters and fully ranked units of your own. With the rank and outnumbering bonuses, you should be able to counter the powerful Treemen, Tree Kin, and Dryads.
- C. Most units that will be assigned the duty of slowing down your troops and preventing you from marching will be small and relatively weak in combat. Use whatever you have at your disposal that can effectively threaten these enemy units: your own *Skirmishers* or *Fast Cavalry*, heavy cavalry, accurate missile troops, some spells, and some artillery pieces.



COLORS OF WAR



KEY

■ Top Box(es): Basecoat Colors & Ink Washes ■ Bottom Box(es): Highlights ■ Mixed Colors



*Snot Green, Bestial Brown
Catachan Green, Graveyard Earth*



*Dark Angels Green, Dark Flesh
Camo Green, Vermin Brown*



*Scab Red, Bubonic Brown
Terracotta, Desert Yellow*



*Shadow Grey, Graveyard Earth
Skull White, Kommando Khaki*



*Desert Yellow, Codex Grey
Kommando Khaki, Fortress Grey*



*Snot Green, Codex Grey
Scorpion Green, Skull White*

Above: Wood Elf Scouts painted by Jeff Wilson.

Far Right: With this model, Matt Parkes won the Open Competition in the 2001 U.K. Golden Demon painting competition.

Below: This magnificent diorama by David Nelson came in first at the U.S. Golden Demon painting competition in 2000.



*Dark Angels Green, Golden Yellow
Goblin Green, Bad Moon Yellow*



*Scorched Brown, Scorpion Green
Bubonic Brown, Scorpion Green & Skull White*



SHOWCASE



ALTERNATE MODEL – CORE
Eternal Guard

COMPONENTS FOR 4 COMPLETE MODELS

- 99360209001 Goblin Shield Sprue (x2)
- 99380204001 Glade Guard Sprue
- 99380210001 High Elf Spearmen Sprue

COMPLEXITY RATING



ALTERNATE MODEL – HERO
Branchwraith

COMPONENTS FOR 1 COMPLETE MODEL

- 99380207001 Skeleton Warrior Sprue
- 9947020113706 Nurgle Lord Signpost
- 99830204002 Dryads Sprue

COMPLEXITY RATING



Below: These Dark Elf Dark Riders were converted by Jeff Wilson into Wood Elf Glade Riders.



SHOWCASE



Left: Jeff Wilson's "Killing Blow" won third place at the 2005 Atlanta Golden Demon painting competition.



Above: Jesse Arias earned a second place Golden Demon with this fabulous unit of Waywatchers at the 2004 Chicago Golden Demon painting competition.

Left: Gerry Hodgson's "Beastlord vs. Wood Elf" won second place at the 2004 Canadian Games Day Golden Demon painting competition.

Below: Jeff Wilson's Dryads won first place at the 2004 Atlanta Games Day Golden Demon painting competition.



SHOWCASE

Below: Jeff Wilson's Wood Elf Dragon won second place at the 2004 Baltimore Games Day Golden Demon painting competition.



All miniature are supplied unpainted. Models, kits, and sprues are all shown at full size unless otherwise noted. Contents may vary slightly from those shown.



WARHAMMER SIEGE

Captain von Blitterstein gazed out over the parapets and fought back despair. Although cloaked in night, the enemy bore torches, and their lights were beyond counting. The harsh shouting of Orcs could be heard just outside of cannon range. More ominously, the distant hammering, sawing, and cursing could only mean that the greenskins were building siege machines. Tomorrow's light would undoubtedly reveal hastily assembled battering rams, ladders, and siege towers. The devices would be crudely constructed, almost comical, but von Blitterstein knew the dangers of such devices and had no intention of laughing.

Before the morning assault, the catapults would be assembled and pushed forward into range under the cover of darkness. The timbers, groaning and straining under severe tension, would soon heave great boulders to smash into the castle walls. The Empire cannon crews had already been assembled and briefed. Each cannon would have to attempt to out-duel and destroy the enemy machines before damage could breach the wall. A single well-placed cannonball could smash the greenskin catapults into a ruined pile of broken kindling – but there were so few cannon that defeat seemed inevitable.

By morning, the overwhelming numbers of Orcs would be revealed. Dozens of ladders would be flung up against the walls, wheeled battering rams would smash into the gates, and enormous siege towers would be pushed forward to unleash hordes of troops on the battlements. Sigmar preserve us, thought the Empire Captain, it is going to be a hard fight.



Above: A unit of Skeletons carries a custom-made log battering ram.

Below: Rob Kendzie's amazing scratch-built Bretonnian castle has far more flair and style than the rugged strongholds of the Empire.

One of the ultimate challenges for Warhammer players is the siege battle. Sieges are also a chance for modelers and terrain makers to have some fun as well.

Very simply, a siege battle takes place when the Defenders are protected by defensive terrain. The defensive terrain could represent protective walls, hedgerows, or natural barriers. Most often, however, defensive terrain means specially constructed fortifications to ward off enemies. The castle or fortress is the pinnacle of all defensive structures.



Above: With a combination of plastic sprues and Warmaster bases, the exterior of this castle has been embellished to represent the fine keep of a prince or rich duke.

SIEGES IN WARHAMMER

The rules for playing sieges in Warhammer can be found in the Warhammer rulebook. There is an entire *Appendix* section dedicated to the rules for scaling walls, battering down gates, bombarding castle walls, and more. Additional rules, scenarios, and army upgrades (like camouflaged Wood Elf towers and Ironclad Dwarf fortresses) can be found in *The General's Compendium*.

On the following pages, you will find the Warhammer Fortress and Siege Tower for conducting your own siege battles.

The Warhammer Fortress is an easy way to have a castle in an instant. The fortress is also a fantastic base for modelers to start from when creating their own defensive works. Really ambitious terrain makers can check out the Games Workshop web site for more castle-making ideas.

A siege game can be as simple as a small band of warriors trying to throw down a lonely watchtower or can be as vast and elaborate as an assault to capture a sprawling enemy fortress.

Whether you are reducing the local Vampire Count's castle to rubble or attempting to storm a walled Empire city, a good Warhammer game can be transformed into an amazing siege battle with the right materials.

An Orc & Goblin horde breaks through the wall's defenses and presses the attack into the Empire city.

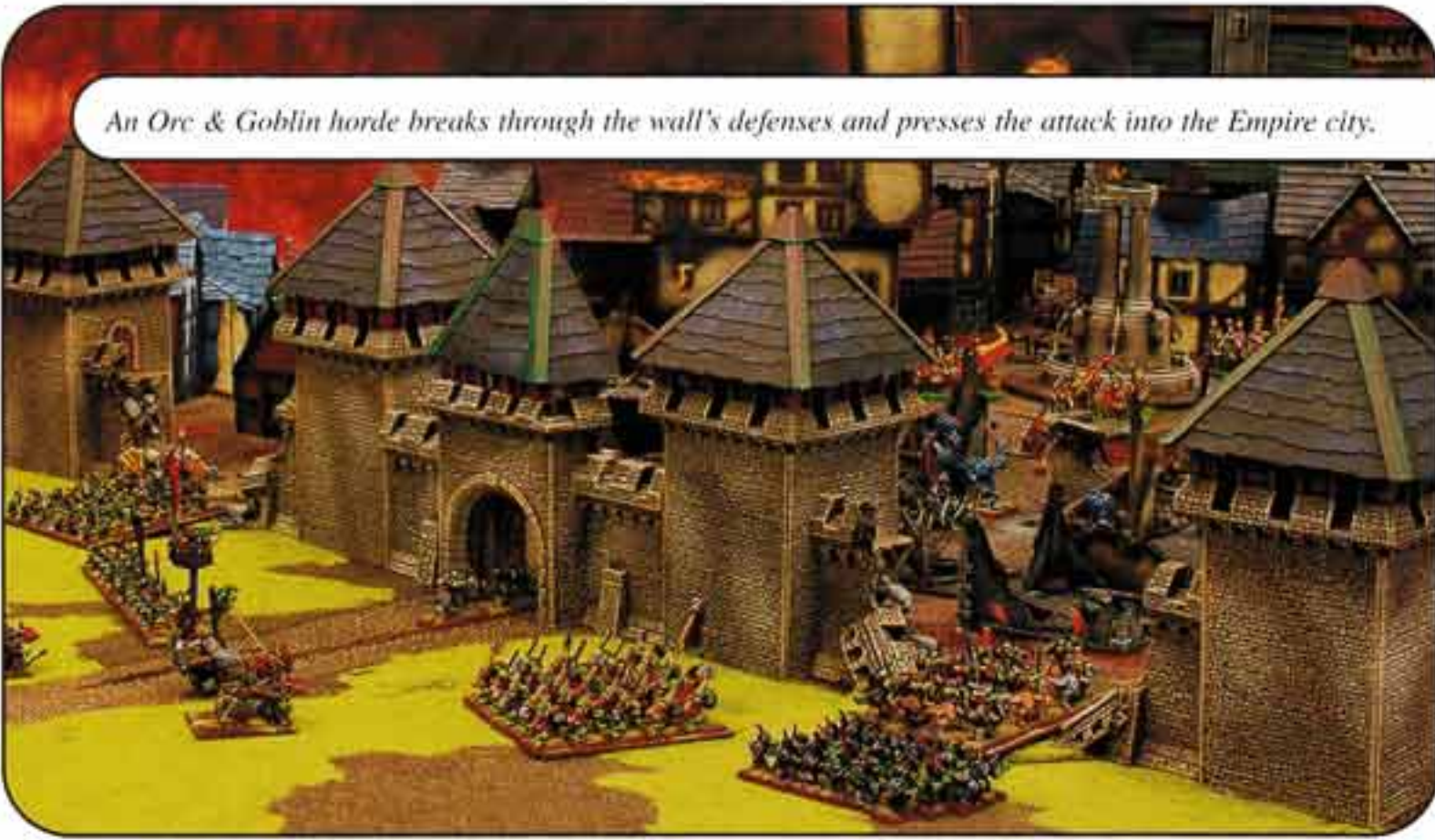

GETTING STARTED

The Warhammer rulebook contains all the information needed to fight Siege battles.

The rulebook is a great place to start on the road to conquering the enemy's castles.



**Warhammer
Fantasy Rulebook**
60040299004

Paul Capon's Siege of Brionne diorama won first place in the Battle Scene category at the 2003 U.K. Games Day Golden Demon painting competition.



SIEGE

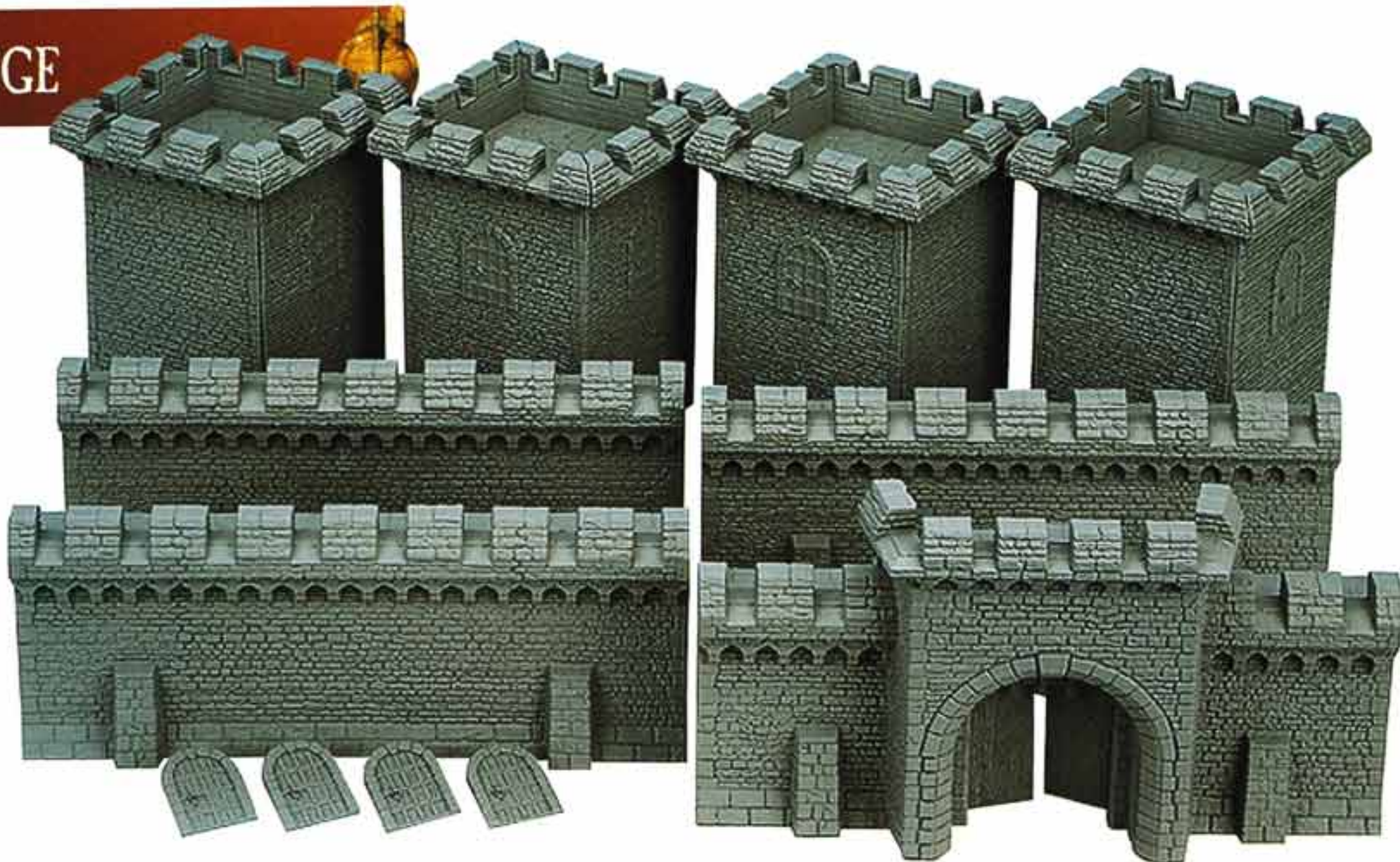

Warhammer Fortress Towers (1)
99220299014

Warhammer Walls (1)
99220299015

Warhammer Fortress Gateway (1)
99220299016



Warhammer Fortress
99220299001

SIEGE



Warhammer Siege Tower
99120299001



NURGLE SIEGE TOWER

Here is a siege tower dedicated to the foul plague God Nurgle. This tower was scratch-built out of balsa wood by Kenny Goodman. A fantastic model like the one pictured here is just one example of the siege engines that you could make for your army!



Above, the siege engine prepares to vomit forth Chaos Warriors of Nurgle onto the ramparts.



A little modeling putty goes a long way in creating cool extra bits for your custom-built siege tower.

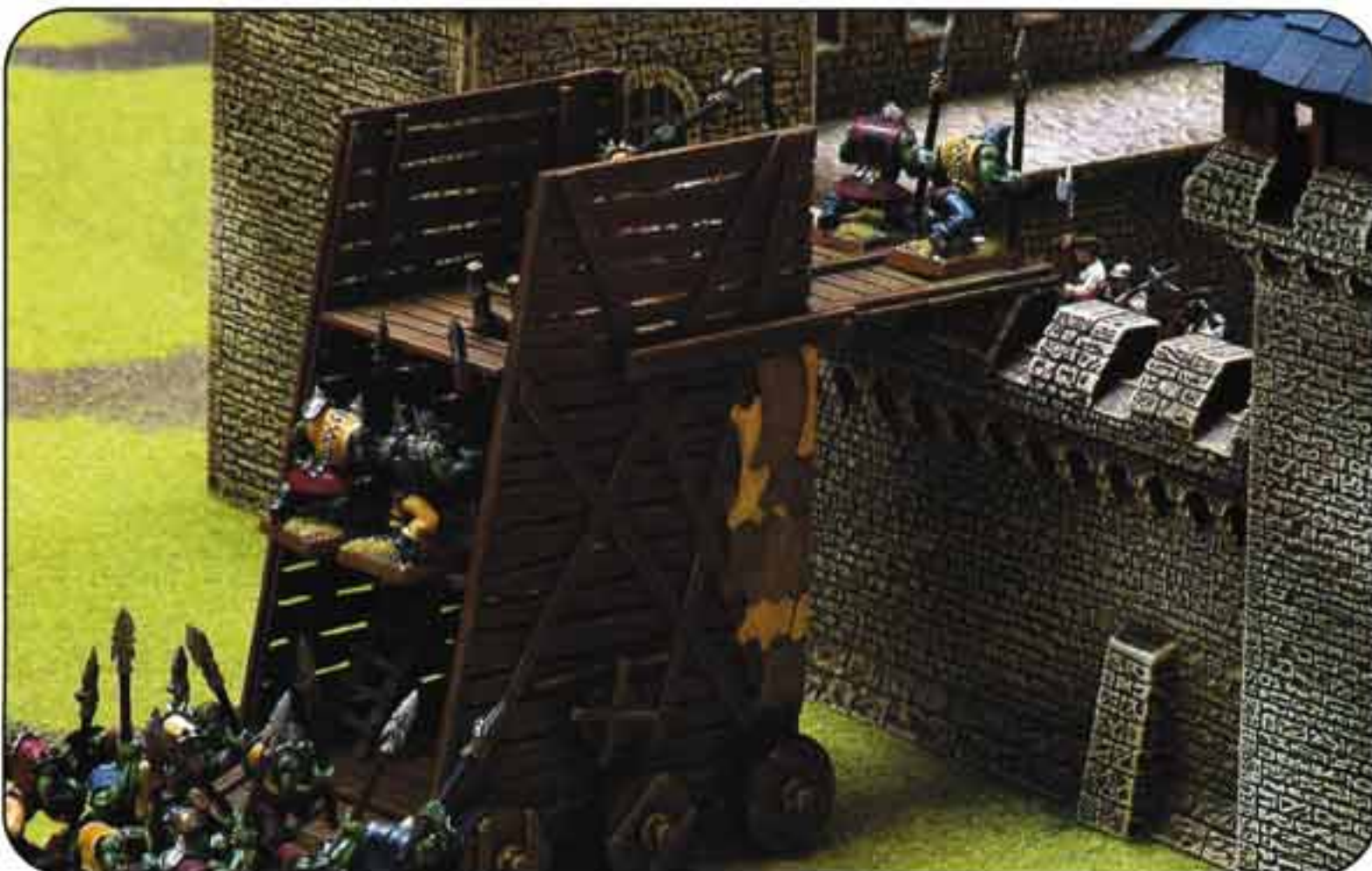



THE LORD OF THE RINGS

STRATEGY BATTLE GAME

*One Ring to rule them all, One Ring to find them,
One Ring to bring them all, and in the darkness bind them.*

Middle-earth on Your Tabletop

The Lord of The Rings Strategy Battle Game allows players to re-create all the action of Middle-earth. Begin the journey as the four Hobbits set out across the Shire, join the Fellowship, and dare to enter the murky dangers of Moria. You can charge with the Riders of Rohan to rid the land of Orcs or help stem the tide of Saruman's Uruk-hai at the Siege of Helm's Deep. From small skirmish games revolving around the well-known heroes to the massive battles of the Last Alliance or Pelennor Fields, The Lord of The Rings game puts the excitement right onto your tabletop.

The Range

The Lord of The Rings range of Citadel Miniatures contains all the figures a collector will want to represent his or her favorite character, monster, or troop type from the movies. Even better, gamers will find the

extensive range and variety of figures ideal for gathering models to play all the scenarios from the action scenes of the movies. It is even possible to build up great armies for larger and more glorious battles.

The Lord of The Rings Strategy Battle Game was available originally in three separate sets, one for each film. However, a complete rulebook that encompasses all three sets is now available for you to re-enact the adventures of the film trilogy. For those who want to expand their games of The Lord of The Rings, there are a number of supplements that allow you to explore Middle-earth beyond the story presented in the movies. Travel deep into the Mines of Moria with *Shadow & Flame*, ride with the Rohirrim to *The Battle of Pelennor Fields*, defend the gates of Minas Tirith with *Siege of Gondor*, or defend the lands of the Hobbits in *The Scouring of the Shire*. The possibilities for games in Middle-earth are endless with The Lord of The Rings game!



Below: The Fellowship of The Ring by Jeff Wilson won first place in The Lord of The Rings Group or Large Monster category at the 2004 Atlanta Games Day Golden Demon painting competition.



Above: John Marsiotta's Treebeard won first place in The Lord of The Rings Large Model category at the 2004 Canadian Games Day Golden Demon.



Above: Lilianna Troy's Gimli won second place in The Lord of The Rings Single Miniature category at the 2004 LA Golden Demon.

The Lord of The Rings Strategy Battle Game is different from Warhammer and Warhammer 40,000 in that it focuses less on conflict between large armies and more on story-driven scenarios. A good place to start is with the basic boxed game shown below. It contains the full rules for playing and scenarios based on the final chapter in the The Lord of The Rings trilogy. From there, you can purchase rules supplements and special miniatures for use in the multitude of scenarios and battles from either the books or your own imagination.

GETTING STARTED



The Lord of The Rings: The Mines of Moria 60011499004

- 112-page rulebook for getting started
- The Fellowship of The Ring, 24 Moria Goblins, & 1 Cave Troll
- Balin's Tomb Terrain

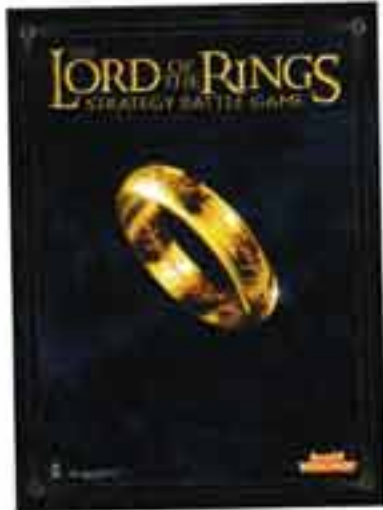

The Lord of The Rings: Strategy Battle Game Rulebook 60041499012

- 240-page complete rulebook

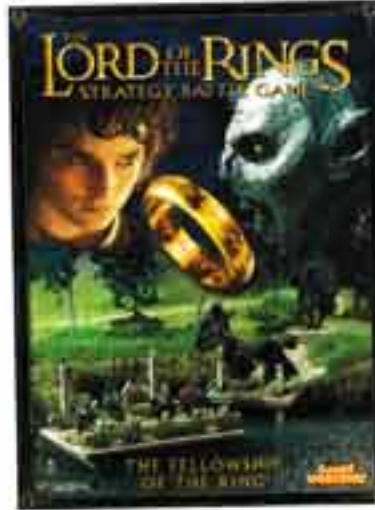

The Lord of The Rings: The Fellowship of The Ring Journeybook 60041499013

- 96-page book covering gaming, collecting, and hobby material centered around the first chapter in The Lord of The Rings trilogy.



The Breaking of The Fellowship Box (9)
99111499052



THE LORD OF THE RINGS



Aragorn



Legolas



Frodo



Sam



Boromir



Gimli



Pippin



Merry



Gandalf

The Fellowship of The Ring Box (9)
99111499002



Aragorn



Frodo



Sam



Merry



Campfire



Pippin



The Witch-king



Ringwraith



Ringwraith



Ringwraith



Ringwraith

Attack at Weathertop Box (10)
99111499001

THE LORD OF THE RINGS



Isildur Blister (2)
99061464074

Giant Eagle Blister (1)
99111499048



Legolas



Gimli



Aragorn



Dying Boromir



Uruk-hai with Merry



Uruk-hai with Pippin



Uruk-hai Warriors



Lurtz

Ambush at Amon Hen Box (24)
99111499004



THE LORD OF THE RINGS



Mounted Gandalf the Grey

Model coming
soon!

Picture not available at press time.

Gandalf the Grey (2)
99061464093



Boromir Blister (2)
99061464080



Elrond & Gil-Galad Blister (1)
99061463015



Lorien Elf Bowman Blister (Random 3)
99061463007



Legolas Blister (2)
99061463021



Haldir & Celeborn Blister (2)
99061463020

THE LORD OF THE RINGS



Warriors of the Last Alliance Box (24)
99121499002



High Elf Spearmen Blister (Random 3)
99061463006



Gondorian Bowmen Blister (Random 3)
99061464002



Gondorian Spearmen Blister (Random 3)
99061464003



THE LORD OF THE RINGS



Aragorn Blister (2)
99061464079



Gandalf Blister (2)
99061464077



Faramir's Rangers Blister (Random 3)
99061464023



Faramir
Faramir & Damrod Blister (2)
99061464031



Riders of Rohan Box (6)
99121499004

THE LORD OF THE RINGS



Treebeard, Mighty Ent Box (1)
99111499011



Gollum



Sam



Frodo

Gollum, Sam & Frodo – The Two Towers Blister (3)
99061499014



Warriors of Rohan Box (24)
99121499007



THE LORD OF THE RINGS



Theoden Blister (2)
99061464082



Gamling Blister (2)
99061464083



Eowyn Blister (2)
99061464088



Aragorn, King of Gondor Blister (2)
99061464078



Eomer Blister (2)
99061464087

Haldir on Foot With Bow
Model coming soon!

Picture not available at press time.

Haldir on Foot w/ Bow (1)
99061463024



Faramir Blister (2)
99061464085

THE LORD OF THE RINGS



**Knights of Minas Tirith
Standard Bearer Blister (1)**
99061464040



Elendil & Isildur Blister (2)
99061464027



Denethor & Armored Boromir Blister (2)
99061464086



Dunedain of the North Blister (Random 3)
99061464090



Guardians of the Shire Box (6)
99111499056

The Guardians of the Shire boxed set (99111499056) contains Gildor and 5 different unarmored Rangers, although only one Ranger is shown here.



King of the Dead Blister (1)
99061466011



The Army of the Dead Blister (Random 3)
99061466012



THE LORD OF THE RINGS

Arwen on Foot and Mounted

Model coming soon!

Picture not available at press time.



Arwen (2)
99061463022

Sam & Bill the Pony (2)
99061461015



Rohan Royal Guard Blister (3)
99061464020



Armored Merry & Pippin (2)
99061461007



Mounted Rohan Royal Guard Blister (Random 1)
99061464033

THE LORD OF THE RINGS



Warriors of Minas Tirith Command Blister (Random 2)
99061464036

Guard of the Fountain Court Blister (Random 3)
99061464017



Warriors of Minas Tirith Box (24)
99121499008



Haldir's Elves with Bows Blister (3)
99061463013

Haldir's Elves with Swords Blister (3)
99061463014



THE LORD OF THE RINGS



Sauron Box (3)
99111466007



Sharku Blister (2)
99061462032



Gorbag
Shagrat
Gorbag & Shagrat Blister (2)
99061462024



Saruman & Grima Blister (2)
99061464076



Gothmog Blister (2)
99061462033



Goblin Captain With a Bow
Model coming soon!

Picture not available at press time.

Goblin Captains (2)
99061462034

THE LORD OF THE RINGS



Ringwraith Blister (Random 1 Mounted & 1 on Foot) 99061466019 Ringwraith Box (Random 9 on Foot) 99111499049

The Ringwraith boxed set (99111499049) contains four new Ringwraiths that are not shown here.



Witch-king of Angmar Mounted
Model coming soon!

Picture not available at press time.

Witch-king of Angmar Blister (2)
99061466021



Suladan Blister (2)
99061464089

Lurtz With a Bow
Model coming soon!

Picture not available at press time.

Lurtz (1)
99061462035



Lurtz & Grishnakh (2)
99061462030



THE LORD OF THE RINGS



Balrog Box (1)
99111499050



Moria Goblins Box (24)
99121499003

THE LORD OF THE RINGS



Ringwraith on Fell Beast & Frodo Box (2)
99111499027





THE LORD OF THE RINGS



Uruk-hai Battering Ram Blister (1)
99061462016



Uruk-hai Command Blister (Random 2)
99061462014



Uruk-hai Siege Ballista Box (1)
99111499009



Uruk-hai with Crossbows Blister (Random 3)
99061462012



Uruk-hai Berserkers Blister (Random 3)
99061462013

THE LORD OF THE RINGS



The Fighting Uruk-hai Box (24)
99121499005



Uruk-hai Siege Troops Box (10)
99121499006



THE LORD OF THE RINGS



Witch-king on Fell Beast Box (1)
99111499032





THE LORD OF THE RINGS



Mordor Orcs Box (24)
99121499009



Mordor Uruk-hai Blister (Random 3)
99061462021



Mordor Orcs Command Blister (Random 2)
99061462020



Easterlings Command Blister (2)
99061464045



Easterlings Blister (Random 3)
99061464044

All miniatures are supplied unpainted. Models, bits, and pieces are all shown actual size unless otherwise noted. Contents may vary slightly from those shown.



THE LORD OF THE RINGS



Cave Troll with Spear Blister (1)
99061466008



Cave Troll Blister (1)
99061466004



Wildmen of Dunland Blister (Random 3)
99061464025



THE LORD OF THE RINGS



Mordor Troll Box (1)
99111499030



The Mouth of Sauron Blister (2)
99061466010



Shelob
In the Clutches of Shelob Box (3)
99111499029



The Lord of The Rings Terrain Pack
99221499007





SHADOW & FLAME

Moria. You fear to go into those mines. The Dwarves delved too greedily and too deep. You know what they awoke in the darkness of Khazad-dûm: shadow and flame.

—Saruman the White

The *Shadow & Flame* supplement is an invaluable guide to more gaming in Middle-earth. Inside, you will find rules for Balin and his Dwarves who dared to attempt to reclaim Moria from the darkness. Four linked scenarios re-create the struggle of the Dwarves versus the Goblins and the mighty Balrog. Additional rules cover Tom Bombadil, the Barrow Wights, Glorfindel, Radagast the Brown, and more. Three more scenarios explore battles in Rivendell, the Barrow Downs, and Fangorn Forest. Also included are painting tips, scenery, and more.



**Shadow & Flame
Rulebook**
60041499004



**Dwarf Lords
Dain & Balin Blister (2)**
99061465012



Khazad Guard Blister (Random 3)
99061465008



Dwarf Warriors Blister (Random 3)
99061465006



Dwarf Bowmen Blister (Random 3)
99061465007



**Moria Goblin Drummers
Blister (3)**
99061462010



**Goblin King of Moria
Blister (1)**
99061462009



**Moria Goblin Shaman
Blister (1)**
99061462017

SHADOW & FLAME



Uruk-hai Shaman Blister (1)
99061462019



Radagast the Brown Blister (1)
99061464034



Glorfindel Blister (2)
99061463010



Elladan & Elrohir Blister (2)
99061463018



The Fog on the Barrow Downs boxed set (99111499018) contains all of the models shown below.



Fog on the Barrow Downs Box (10)
99111499018



Barrow Wights Blister (2)
99061466005



This blister pack is only available via special offer.



Tom Bombadil & Goldberry Blister (2)
99061499041



SIEGE OF GONDOR

*This will be the end of Gondor as we know it.
Here the hammer-stroke will fall hardest.*

—Gandalf the White

Throughout the colorfully illustrated pages of this supplement to The Lord of The Rings Strategy Battle Game, you will find essential rules, information, and inspiration to bring even more detail to the battles of Middle-earth on your own tabletop. Included inside are the complete gaming rules for fighting sieges throughout Middle-earth, new warriors for the forces of Good and Evil, six linked scenarios to re-create the desperate battle for Gondor as Sauron sends forth his legions, and two additional scenarios to play out the tense and dramatic siege of Helm's Deep. In addition, you'll also find detailed advice on preparing your fortifications and siege towers, together with inspiring photographs of all the new models and scenery that have been designed for this book.

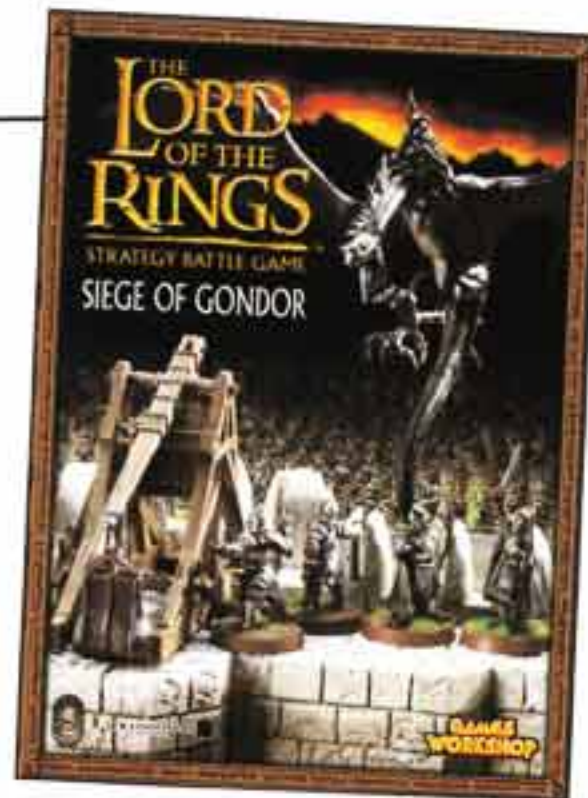

**Siege of Gondor
Rulebook**
60041499007



Gondor Battlecry Trebuchet Box (1)
99111499022



**Beregond
Blister (1)**
99061464051



**Gondor Avenger Bolt Thrower Blister
(1 War Machine & 3 Crew)**
99061464049



SIEGE OF GONDOR



Mordor War Catapult Box (1)
99111499040



Orc Trackers Blister (3)
99061462025



Orc Shaman Blister (Random 1)
99061462027



Mordor Siege Bow Blister (1 War Machine & 3 Crew)
99061462028



Morannon Orcs Blister (Random 3)
99061462029



THE BATTLE OF PELENNOR FIELDS

A day may come when the courage of men fails, when we forsake our friends and break all bonds of fellowship, but it is not this day.

—Aragorn

This supplement for The Lord of The Rings Strategy Battle Game brings new characters, warriors, and war machines for both the forces of Good and Evil to the front, including the amazingly huge Mûmakil! The first half of the book charts the progress of the armies of Harad as they march northward to the great widow-making fields of Gondor, while the second half of the book is given over to reprising those evocative moments from the films and the books where the warriors of Harad have a key role. There are rules for new Warriors and Heroes, as well as the Mûmakil to use in your games. There are also 11 new scenarios that stretch across the arid land of Harad, and travel northward across the Poros and Harnen rivers until they reach the Pelennor Fields themselves. In addition, you'll find modeling and painting advice for bringing your warriors to life.

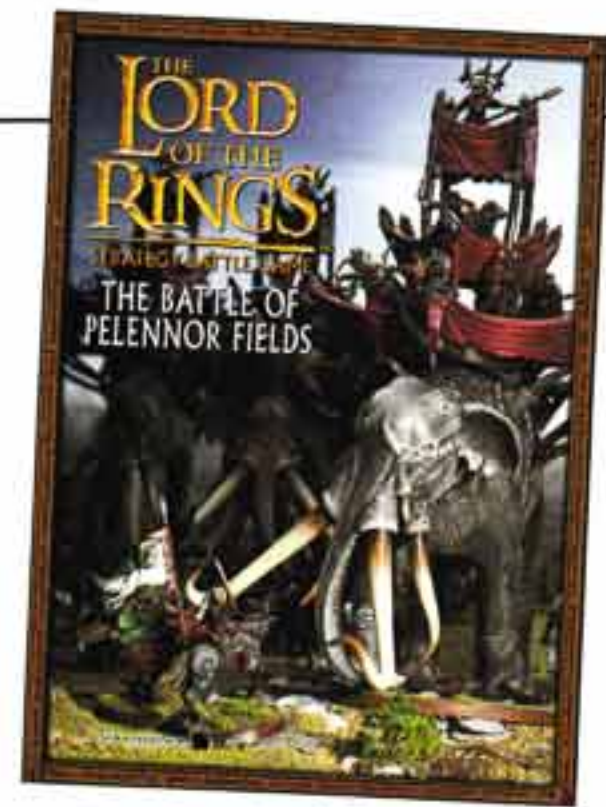

The Battle of Pelennor Fields Rulebook
60041499008



Prince Imrahil of Dol Amroth Blister (2)
99061464058



Knights of Dol Amroth on Foot Blister (Random 3)
99061464063



Knight of Dol Amroth Mounted Blister (Random 1)
99061464062

THE BATTLE OF PELENNOR FIELDS



Halbarad, Captain of the Dunedain Blister (1)
99061464060



Rangers of the North (Random 3)
99061464061



Warriors of Harad Box (24)
99121499011



THE BATTLE OF PELENNOR FIELDS



Haradrim Horsemen Chieftain Blister (2)
99061464070



Haradrim Raider Blister (Random 1)
99061464069



Hâsharii Blister (1)
99061464065



Mûmak Mahud Blister (1)
99061464075



Troll Chieftain Box (1)
99111499033



Haradrim Command Blister (2)
99061464066



THE BATTLE OF PELENNOR FIELDS



Mûmakil of Harad Box (24)
99121499010

All miniatures are supplied unpainted. Models, bits, and spores are all shown as they will look unless otherwise noted. Contents may vary slightly from those shown.



THE SCOURING OF THE SHIRE

Hobbits really are amazing creatures! You can learn all that there is to know about their ways in a month, and yet after a hundred years, they can still surprise you.

**–Gandalf to Frodo
The Fellowship of The Ring**

The newest supplement for The Lord of The Rings Strategy Battle Game contains the requisite new assortment of warriors and heroes for both Good and Evil, but this time the focus shifts from the vast expanses of Middle-earth to the relatively small confines of the once-peaceful Shire. The nefarious Sharkey and his recruited band of ruffians infiltrate the home of the Hobbits and begin to wreak havoc. The Halflings are left with no choice but to fight to protect their home and drive the evil out. Bring this struggle to life with the new rules, scenarios, and modeling projects contained within this book.

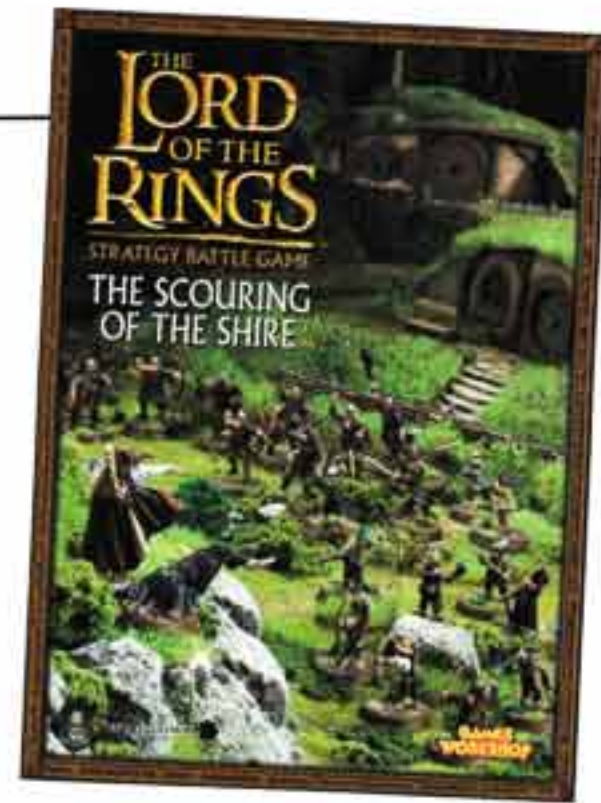

**The Scouring of the Shire
Rulebook**
60041499011



The Scouring of the Shire Box (6)
99111499046



Hobbits of the Shire Blister (3)
99061461011



Farmer Maggot & Hounds Blister (4)
99061461012



Hobbit Archers Blister (4)
99061461009



Hobbit Militia Blister (4)
99061461010

THE SCOURING OF THE SHIRE



Ruffians & Slavers Blister (Random 3)
99061464071



Hobbit Shiriffs & Bounders Blister (4)
99061499047



Bandobras "Bullroarer" Took Blister (2)
99061461013



Gollum Blister (2)
99061466017

 This blister pack is only available via special offer.



Lobelia Sackville-Baggins Blister (1)
99061461016



The Warg Riders boxed set (99111499046) contains plastic sprues to build up to 6 Warg Riders.



Warg Riders Box (6)
99111499046



SHOWCASE



Right: David Pauwels' Shelob won first place in The Lord of The Rings Group or Large Monster category at the 2004 Chicago Games Day Golden Demon painting competition.



Above: At the 2004 Los Angeles Games Day Golden Demon painting competition Angela Imrie's Elrond (Right) won first place and Jarrett Lee's Barrow Wight (Left) won third place in The Lord of The Rings Single Miniature category.



Left: Eowyn, painted by Zack Lanier, won first place in The Lord of The Rings Single Model category at the 2004 Canadian Games Day Golden Demon painting competition.



At the 2004 Baltimore Games Day Golden Demon painting competition, Andrew Cromwell's Legolas (Left) won third place and Brett DeWald's Galadriel (Above) won second place in The Lord of The Rings Single Model category.



Above: Marike Reimer's Goldberry won first place in The Lord of The Rings Single Model category at the 2004 Chicago Games Day Golden Demon painting competition.



Above: Zack Lanier's Orc Shaman won first place in The Lord of The Rings Single Model category at the 2004 Baltimore Golden Demon painting competition.

Left: Keith Rudis's Elves won third place in The Lord of The Rings Group or Large Monster category at the 2004 Atlanta Games Day Golden Demon painting competition.

SHOWCASE



At the 2004 Atlanta Golden Demon painting competition Doug Bissett's Mordor Troll (Above) won second place in The Lord of The Rings Group or Large Monster category and Jeff Freeman's Saruman (Below) won first place in The Lord of The Rings Single Miniature.



Left: Steve Buddle's "We Left None Alive..." won first place in The Lord of The Rings Film Scene category at the 2003 UK Games Day Golden Demon painting competition.

Below: Jamie Welling's "Charge of the Rohirrim" won first place in the Battle Scene category at the 2004 Chicago Games Day Golden Demon painting competition.



SPECIALIST GAMES

Specialist Games is a division of Games Workshop that produces its own line of games, gaming supplements, miniatures, and magazines. In addition to showing off some of the awesome model ranges, this section explains what the Specialist Games division is all about, how you can get the models, and how to find out more.

What Games Are in the Specialist Games Range?

The Specialist Games range includes miniatures and materials for Battlefleet Gothic, Blood Bowl, Epic 40,000, Inquisitor, Mordheim, Necromunda, and Warmaster.

How Can I Get My Hands on All That Great Specialist Games Stuff?

The entire range of Specialist Games is available via special order from:

- ANY participating Independent Retailer
- ANY Games Workshop Hobby Center
- Through Games Workshop Direct Services' Mail Order
- The Games Workshop Online Store

Thus, if you want any Specialist Game, model, bit, or supplement, you can get it. Just ask the staff of your favorite store how to place the order.

Why Was the Specialist Games Division Set up?

The success of the main Games Workshop games – Warhammer, Warhammer 40,000, and The Lord of The Rings – has made it difficult for the main Games Workshop design studio to provide support for the other fantastic gaming systems that Games Workshop has produced over the years. The Specialist Games branch is dedicated to supporting these fine additions to the Games Workshop gaming worlds.

Keep Tabs on What's Going on with Specialist Games

The best way to stay on top of all the happenings and releases for Specialist Games is to keep an eye on the Specialist Games web site, which can be found at:

www.specialist-games.com

This web site is a must-see for fans of any of the Specialist Games ranges. This is a great place, in addition to *White Dwarf*, to see new releases and upcoming new supplements.

You Can Contribute!!!

The support for Specialist Games is written for fanatical GW gamers and by fanatical GW gamers. If you (yes, YOU!) are really

enthusiastic about a Specialist Game, then why not submit some work? A contributions link on the Specialist Games web site details the information that freelancers require.

SPECIALIST GAMES RANGE

Today is 4/13/2005

FANATIC

GAMES

FORUMS

HELP

Exciting New Challenges For The Experienced Gamer

Featured Game: Necromunda

- Gangs fight for control of the Underhive
- Wide variety of different types of gang to choose from
- Extensive campaign rules section
- [Find out more...](#)

Picture of the Day

Epic Death Company Marines, Rhino and Sanguinary Priest Painted by Zac Bellido

Fanatic Online Issue 10

Fanatic's Weekly Online Magazine

Click to download a PDF of an article (Warning: some files may be large and will take time to download)

Tau Army List v4.1

Version 4.1 of the experimental Tau army list for Epic Armageddon is now available from the [Experimentals Rules](#) section of the Epic website.

Sanctioned Blood Bowl Tournament

EPIC

Welcome To Epic

BLOOD BOWL

Blood Bowl

BATTLEFLEET GOTHIC

Welcome to the Battlefleet Gothic website.

INQUISITOR

WELCOME

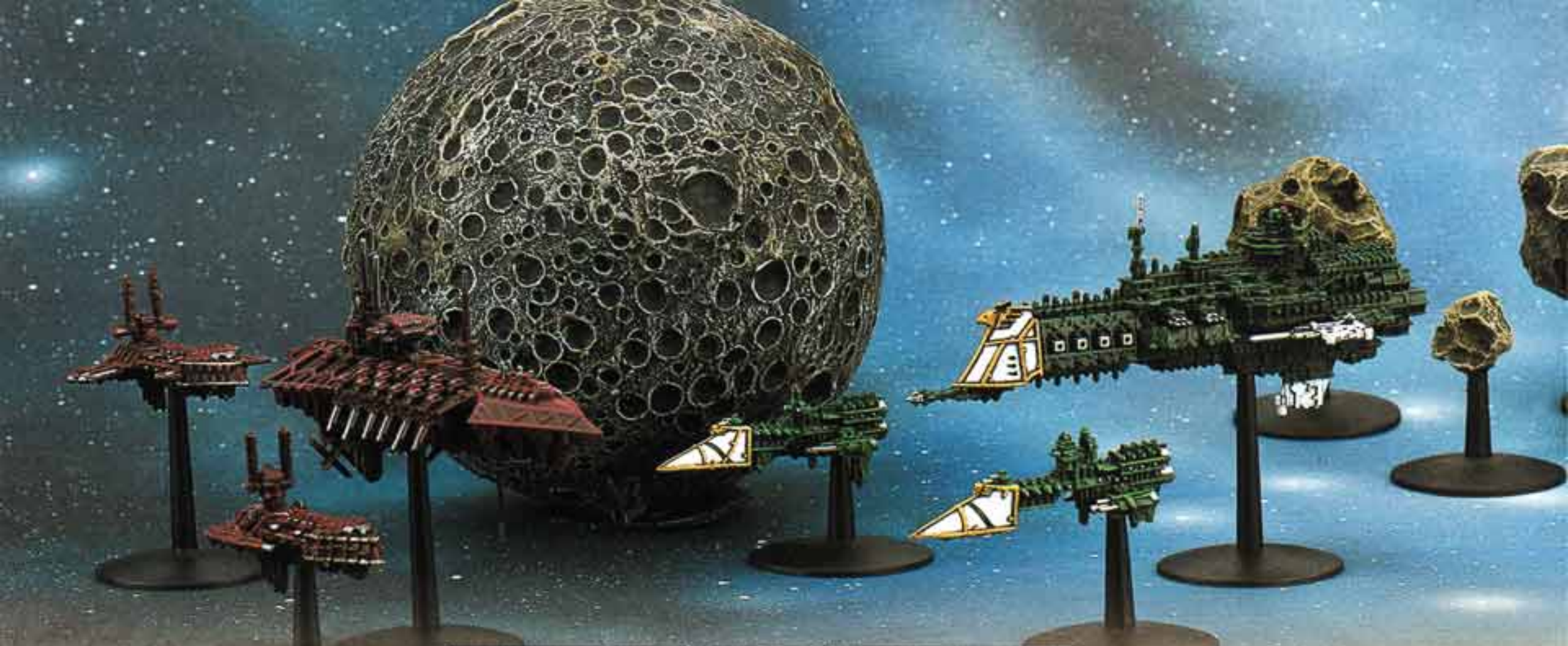

BATTLEFLEET GOTHIC™

There is no peace among the stars. In the void of space, massive battlefleets pierce the darkness to enforce the will of the Emperor. Vast warships maneuver and fire at each other; fighters and bombers are launched in waves; and torpedoes race toward their targets in a life and death struggle for domination of the Gothic sector.

Battlefleet Gothic allows you to command fleets of warships in deadly conflict in the voids of space. The Gothic war was a grim time when the Imperium of Mankind battled for survival in the hostile depths of space. The system was plagued by Ork pirates, Eldar corsairs, and the most dangerous foe of all...Chaos.

The original Battlefleet Gothic game came with rules for four fleets – Imperial, Chaos, Orks, and Eldar. Since that time, the hard-working guys in the Specialist Games Division have made rules and models for Necrons, Tau, Space Marines, Dark Eldar, and other space phenomenon like mines and more.

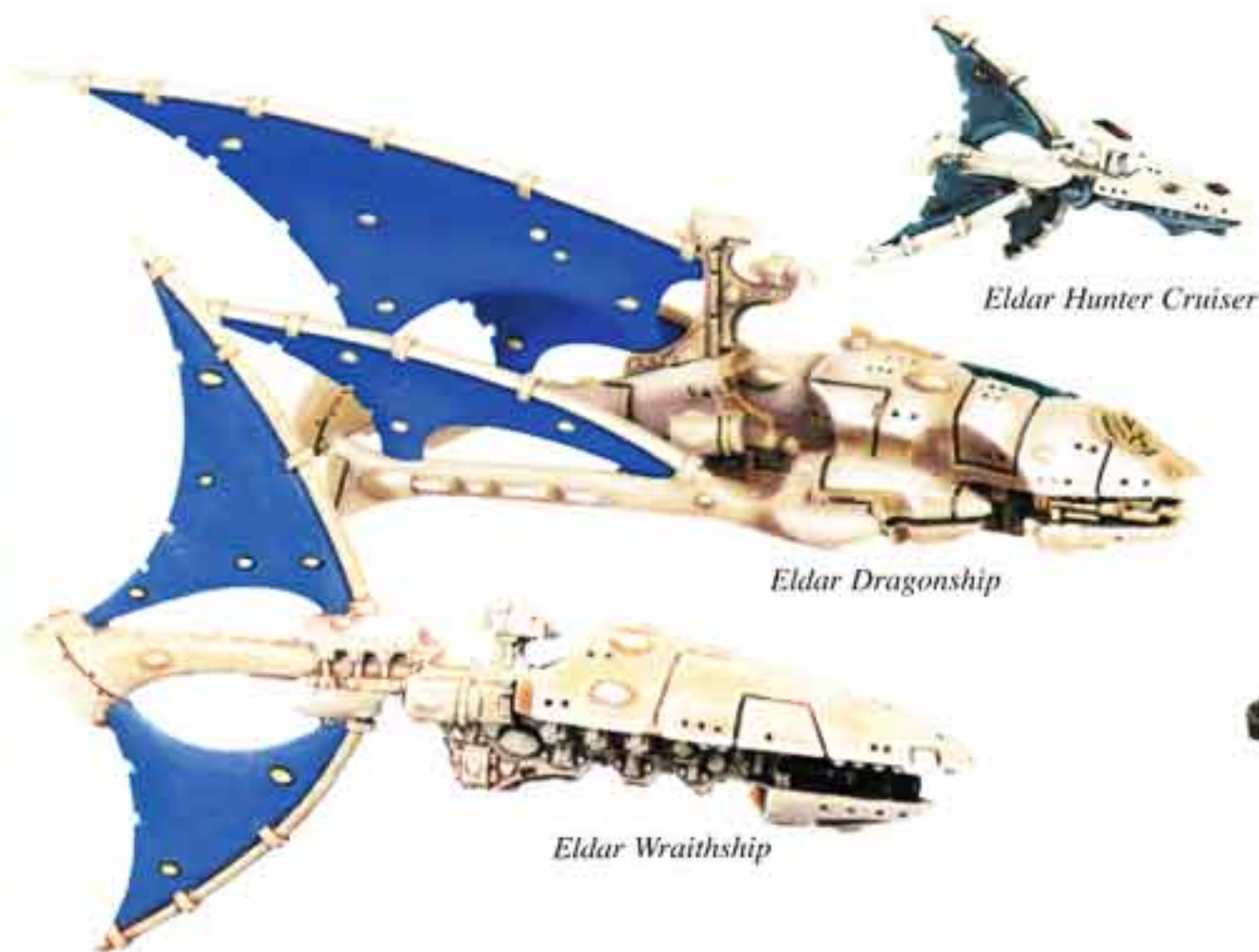

Eldar Hunter Cruiser

Eldar Dragonship

Eldar Wraithship



Rogue Trader Cruiser



Terminus Est, Flagship of Typhus

Many of the races in Warhammer 40,000 are represented in Battlefleet Gothic – perfect for linked campaigns involving whole star systems!

Tired of playing with just the "normal" teams? There are plenty of players to recruit with "extracurricular" skills!

Right: Skaven armed with poisoned dagger

Below: Dwarf Deathroller

Top: Ogre Cheerleader
Bottom: Skeleton with Chainsaw

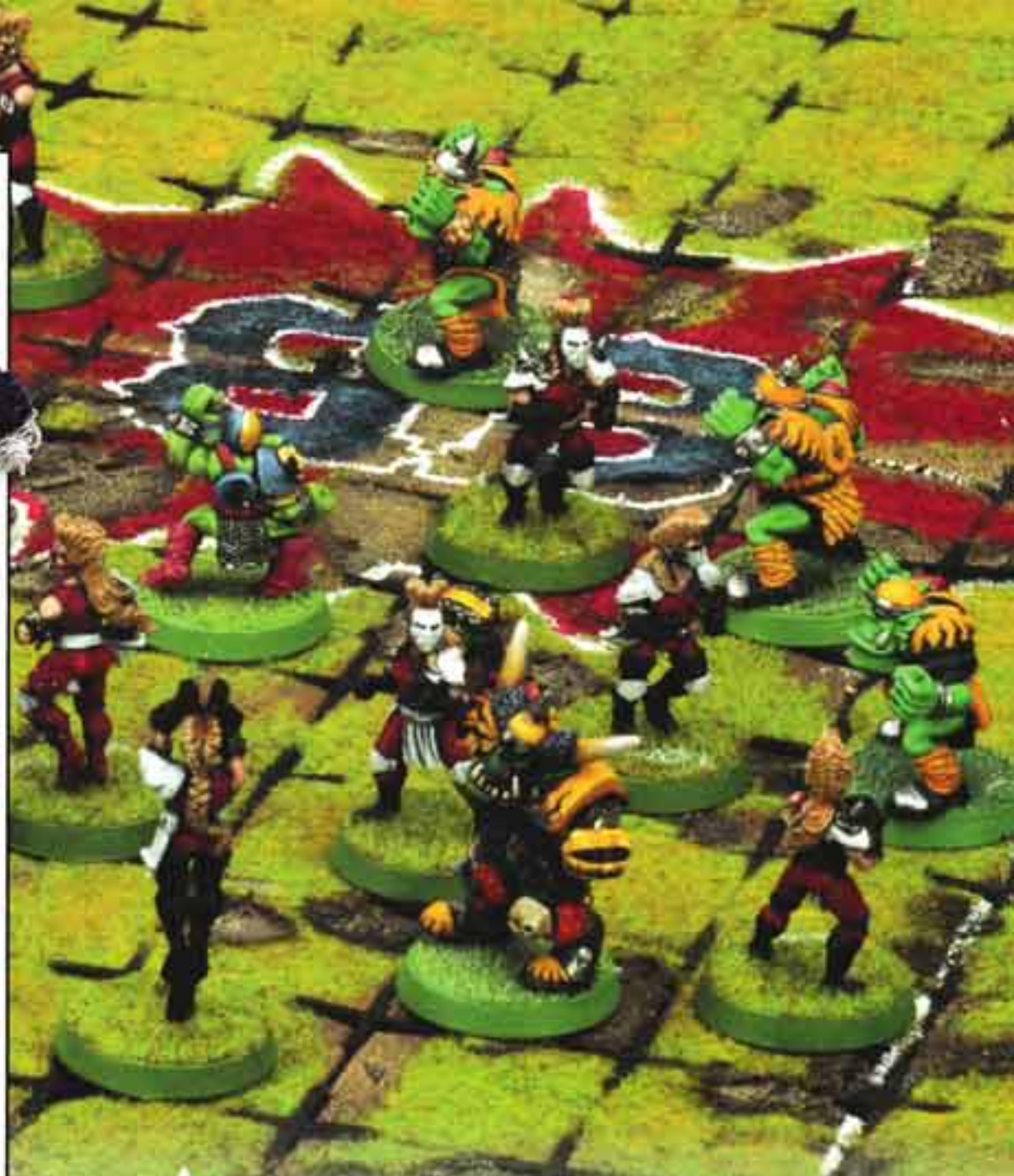

BLOOD BOWL

The Game of Fantasy Football

"Welcome, sports fans, to the hardest-hitting section of the catalog! In these hallowed pages, you will find all the teams fit to take the field (and probably some that are a bit questionable). Additionally, you will find coaches, cheerleaders, and some of the most famous Star Players ever to play the game, grace the pitch, or mangle an opponent. But what's that? You don't know the game of Blood Bowl? Before the match starts, I'd better hand you over to the color commentator, Bob?"

"Thanks Jim. Hard to believe there are any fans out there who have not heard of Blood Bowl. This sport pits two teams of heavily armored and quite insane warriors against each other. Players on each team may pass, throw, or run with the ball in order to get it to the opposite end of their field into the End Zone to score a Touchdown (1 point). Of course, it's true that some players (or whole teams) prefer to ignore the ball and just

pummel and stomp the opposition into the turf – but hey, that's only one strategy! Getting the ball into the End Zone is plenty tough, as the other team is trying to crush the ball carrier, take the ball, and start streaking off in the opposite direction.

"The team with the most Touchdowns at the end of the match is declared the winner. Over the course of a season, teams will hire new team members, recruit Star Players, replace dead players, deal with injuries, and more. It takes a lot of training and hard work to reach the finals! Of course, a little treachery never hurt anybody's chances for victory, either. Well, it looks like tonight's game is about to begin, but before we get underway with the kickoff, we have a special interview with ex-player Stu McGore who has just dropped by the booth. Good to see you, Stu. What's your opinion on the type of game we'll see tonight?"

"Get 'em! Stomp on 'em! Crump 'em!"

"Er...thanks for that, Stu. As I thought, hit in the head and thrown off the playing pitch too many times. Now back to you, Jim..."

League Play

Blood Bowl can be played as an enjoyable one-off game over the course of few hours. To experience the full-tilt, bone-crunching joys of Blood Bowl fully, you have to play a league or season of games!

In most leagues, all players (How many? As many of them as you can round up!) enter their teams in a quest for a particular Cup or Championship. Wins and losses are tracked, and so are Star Player points and the amount of gold crowns earned from fan attendance. Each player builds up his team, fan base, and player skills. Rivalries are established; players gain notoriety; and trades, bribes, and more ensue.

Depending on how gamers structure their league, the matches can last over the course of a weekend, a few weeks, or even months and longer. At the end of the season, a playoff round is battled out by the top players, with the overall winner taking the cup and being declared Champion. Glory, prestige, and poorly hidden ire are heaped upon the winner.

EPIC ARMAGEDDON™

Squad after squad of Infantry file into combat, vast columns of armor, super heavy tanks fire devastating barrages, and massive Titans tower over the battlefield in a combined arms effort to win the day. Epic: Armageddon is warfare in the deadly 41st millennium but on a whole new scale.

War on an EPIC Scale!

The Epic: Armageddon rules allow players to fight battles with Epic-scale models (about 6 or 7 mm tall for a man-sized creature). This fantastic scale allows access to the full spectrum of units and all manner of war machines available to a futuristic

commander or warlord. Where a game of Warhammer 40,000 might have a few tanks per side, the size of Epic: Armageddon allows for dozens upon dozens of such vehicles of destruction to be under the control of each player. You'll need that kind of firepower to take on the enemy! Mighty Titans, immense war machines the size of skyscrapers, stride into the fray. Flyers streak overhead, and squad after squad of infantry hole up in cover to offer support or launch assaults to swarm over enemy armor. The game is all about artillery barrages, swift scouting vehicles, and the kinds of battles that any gamer would truly deem EPIC.

Why Armageddon?

Longtime hobbyists will recognize much in Epic: Armageddon, as it combines many of the previous Epic-scale models and concepts with the Warhammer 40,000 Battle for Armageddon Campaign. Serious veterans will even recall board games about the many struggles on this key Imperial planet.

Epic: Armageddon includes a history of the major wars fought on Armageddon and details the military units that took place in the ferocious fighting that occurred. The new Epic: Armageddon rules are designed to reflect the kinds of battles that were rampant on the planet during the last Ork invasion.



Players of Warhammer 40,000 will find many of their favorite units duplicated in smaller scale in Epic 40,000. In addition to units found in Warhammer 40,000, the smaller scale allows you to field other war machines such as Imperial Guard Valkyries, Eldar Revenant Titans, and truly massive Gargants.





*Top: Inquisitor Jena Orechiel
Middle: Battle Brother Artemis
Bottom: Imperial Arbitrator*

INQUISITOR

You have been told of the Inquisition, that shadowy organization that defends Mankind and the Emperor from the perils of heresy, possession, alien dominance, and rebellion. You have been told the Inquisition is the ultimate defense against the phantoms of fear and terror that lurk in the darkness between the stars.

You have been told the Inquisition employs the bright saviors in an eclipse of evil, the purest and most devoted warriors of the Emperor.

You have been told the Inquisition is united in its cause to rid the galaxy of any threat, from without or within. Everything you have been told is a lie!

For 10,000 years, the forces of the Emperor's Inquisition have fought a secret war to defend humanity from its worst enemies: the alien, the heretic, and the Daemon. But this war is fought as much with hearts and minds as with guns and blade. It is a war without mercy that is fought in the dark, forgotten corners of the galaxy.

Welcome to the shadowy world of the Inquisitor! This narrative wargame allows you to play the part of a bold hero or cruel villain in the horrifying universe of the 41st millennium. Each player controls one or more characters who are represented by large-scale miniatures that move and fight over a tabletop battlefield. This skirmish-level, narrative-driven game adds a whole new level of detail to gaming in the 41st millennium.

The Inquisitor rulebook contains all the rules needed to play as well as a comprehensive armory and details of many special talents, abilities, and psychic powers. Extensive tips and guidance for Games Masters can be found as well as 15 fully detailed sample characters. Inquisitive minds will also find plenty of background for the character types as well as painting and modeling tips. So, for those of you ready for more character and roleplay in your tabletop gaming, Inquisitor is for you.

Inquisitor-Scale Models

Games Workshop has designed an extensive range of Inquisitor models for all of the characters detailed in the Inquisitor rulebook and many more besides. These large-scale models are much bigger than the majority of Citadel Miniatures. Man-sized models in the other GW games are approximately 28 mm high, whereas those for Inquisitor are roughly 54 mm to 60 mm high.

Conversion Ideas

With all the individuality of characters in Inquisitor and the hyper-detailed skirmish rules, many players find themselves doing conversions on their large-scale models. Of course, it is possible to use all the bitz in the Inquisitor range, but cunning converters will be able to find a host of parts throughout the rest of this catalog, especially with large monsters and even some war machines or vehicles!

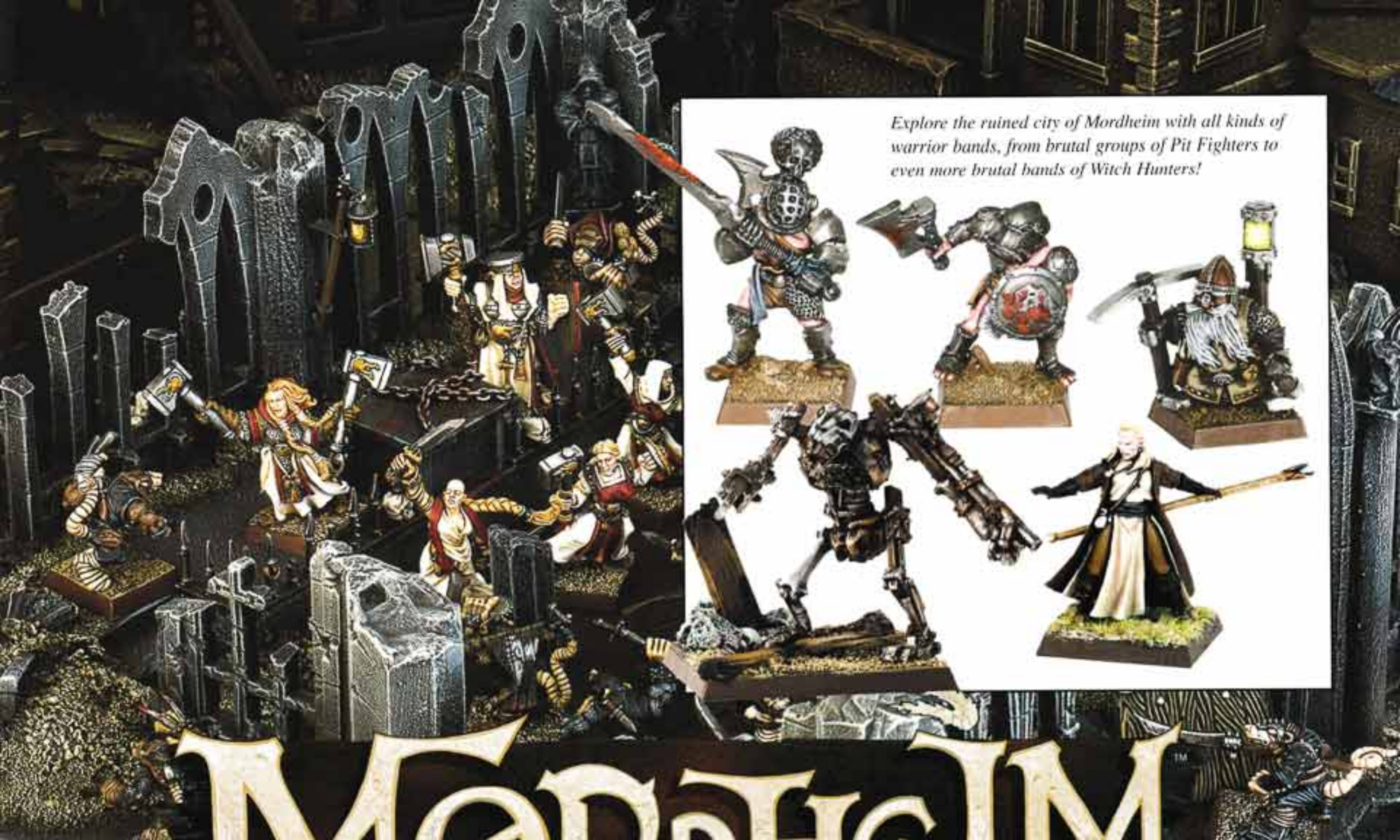

Explore the ruined city of Mordheim with all kinds of warrior bands, from brutal groups of Pit Fighters to even more brutal bands of Witch Hunters!



MORDHEIM

Mordheim, the City of the Damned, is a terrible place of nightmarish ruin, where danger awaits in every shadow. It is here, amid crumbling palaces and twisting streets, that hard-bitten warriors gather to seek out the promise of riches and fame.

Mordheim, the City of the Damned, is a dark, atmospheric game set in the troubled history of the Warhammer world. As a player, you control a warband that is out to earn fame and fortune among the devastated ruins of the once-great city of Mordheim, the cursed city. Mordheim is a skirmish game. The rules are similar to Warhammer but add a level of detail not possible when entire armies of figures do battle. A typical warband size is somewhere between six and a dozen figures. Models can climb the ruins, leap off balconies into combat, crouch in shadowy cover, push foes off precipices, stun or knock down enemies, parry, and score critical hits.

Mordheim can be played as a one-off battle in an evening, but where the game really shines is in the campaign rules that allow players to link together an ongoing series of games in which the warbands will develop

new skills, hire extra warriors, and gain further fame and notoriety. Be careful as you explore the ruins for new treasures. Rival warbands also scour the city and may be lurking in every shadow.

History of the City of Mordheim

Ages ago, a clear and portentous sight was spotted in the night sky over the large and well developed Empire city of Mordheim. It was the twin-tailed comet, the very sign of Sigmar, founder and savior of the land.

As the comet burned closer and closer, lighting up the whole night sky above Mordheim, many pilgrims flocked to the city to join the ongoing celebration. Feasts, dances, and much drinking followed, and the revelry soon grew into debauchery and decadence.

But the comet was not a sign of Sigmar's coming but instead the instrument of his judgement. If the impact of the falling meteorite did not instantly slay the city dwellers, the ensuing fires and mysterious vapors soon did.

Eventually, the ruins cooled, and the few survivors who had been just outside the city when the comet hit began to trickle into the still smoking debris in search of salvage and treasures. Strange stories began to circulate about the wondrous and magical shards of glowing stones that could be discovered in the rubble. Credited with powers of healing and more, the glowing stones were named wyrdstone and were highly sought after.

Soon the ruins of Mordheim were being scoured by small warbands from Reikland, Middenheim, and far away Marienburg, but they were not alone. Skaven, man-sized bipedal rats, emerged and sought the glowing stones too, and Chaos-worshippers gathered in the gloom. Bands of Undead and the Witch Hunters who sought to burn them entered the ruinous gates. Infamous rogues and mercenary cutthroats made their way toward the riches. More and more warbands from the far corners of the Warhammer world began to take interest in what was at stake. Will you dare to enter Mordheim, the City of the Damned?

NECROMUNDA

Necromunda is a game that allows players to take part in the rival gang wars that occur amid the ruined buildings, gantries, and multi-level walkways of the futuristic Hive cities. Players must not only outmaneuver and outfight opponents on the tabletop but also learn how to equip and expand their gangs. The weak do not survive long in the Underhive.

Battles in the Underhive

Necromunda is a fast-playing and atmospheric game that takes place in the vast and horrible Hive Cities of the future. As a player, you control a gang that seeks riches, powerful weaponry, the wonders of age-old technology, territory, or anything else that will help put you on top of your own corner of the slag heaps and tunnels that make up the Underhives of Necromunda.

This skirmish-level game is heaped with detail, like having your gang members gain skills and experience, run out of ammo at a critical time, climb up ladders, leap off balconies into combat, or hire bounty hunters to assist your missions. The armory

lists rules for weapons as well as a full array of useful equipment, like bio-scanners, auto-repairers, bionic eyes, medi-packs, Screammers, and more. The excellent campaign system and scenarios really add a challenge for gangs to live and survive the long haul of the hard life in the Underhive.

The Hives

In the 41st millennium, many planets that were once fair and supported many life forms have been choked and clogged with vast populations and ruinous pollution. Necromunda is just such a planet. The populace, minus vagabond drifters who somehow survive in the Ash wastes, live in enormous Hives. The Hives of Necromunda tower out of the wastelands like mountains. The vast spires reach above the poisoned cloud cover and pierce the atmosphere. In addition to going upward, these vast Hives spread out and downward to far below the surface.

Built up over thousands of years, the many different Hives have sprawling level after level. Some levels are new while others hide

long lost technology or mysteries that were better left undiscovered.

The topmost layers of the Hive are spacious, with domes looking down on the clouds. These upper hive dwellers are the rulers of the Hive and of the very planet itself. Nobility, such as it is, dwells on the next lowest levels. Far, far below the cloud level, where the light of the sun is never seen the Hive City throbs with life crammed into every nook and cranny. Massive industrial complexes, honeycombed sewers, venting, and air filtration systems spread throughout the cramped and polluted underhive. Here dwell the majority of the people – Hivers, as they are called. Still further down, far below the planet's surface is the Hive bottom, which houses unbelievable horrors that have long been forgotten by those fortunate enough to rise above them. The discharged filth and pollution from all the upper levels eventually finds its way to a putrid lake of radioactive matter called the Sump. Here, at the very base of the spire, dwell the mutant dregs, denizens of darkness and pollution.



From pestilent Scavvies to the fiery wrath of the Redemptionists, Necromunda has many different types of gangs, and each player should be able to find one that suits him!

Most Warhammer armies (and even some special characters!) have a Warmaster army version, opening up possibilities for a massive campaign in different scales, all the way from Warmaster to Warhammer Skirmish!

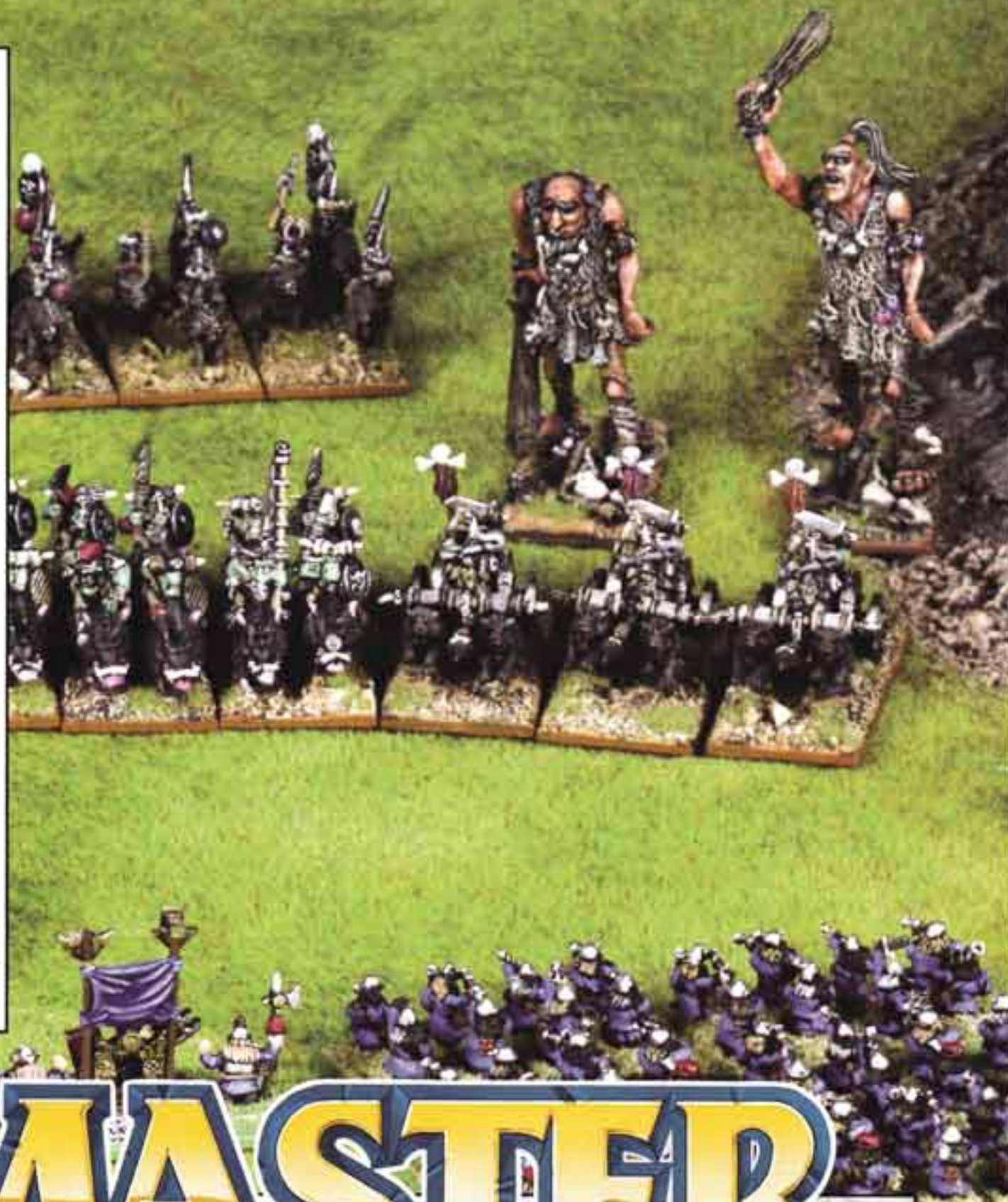

WARMMASTER

Warmaster is a game of conflict on a grand scale in the Warhammer world. The smaller scale of the models allows for a more abstract rules set and larger, more sweeping strategies and tactics. Indeed, it is more the general's ability to command that will win the day over brute strength or individual heroics. Vast armies of infantry, cavalry, artillery, and monsters are arrayed on the fields of battle, and the opposing generals lock wits. Warhammer fans will be thrilled to see their armies and troop types brought to life on a different scale, but the scope of Warmaster makes it a whole new game altogether. Breaking an army's center, destroying the enemy's command and control, and enticing the foe to overextend his battle line are the "grand level" tactics that are part and parcel of Warmaster.

Bold Sweeping Maneuvers and Mighty Battles

The design theme for the game of Warmaster is plain and simple: big battles. The game

firmly places the player in the role of the general making plans, issuing orders, and maneuvering his vast army into an undefeatable position. The emphasis on command control means that it is possible for troops to undertake sweeping flanking moves in a single turn, while other, less fortunate troops just sit back in their Deployment Zone and wait for instructions that never arrive. Certainly, luck plays its part, but a good commander makes use of all the tools at his disposal – heroes, wizards, and others along the chain of command – to issue orders across the far-flung battle lines to make the best luck possible.

To accommodate the grand scale of the battlefield, the models themselves are relatively small. A man is about 10 mm tall compared with a man-sized model from Warhammer or Warhammer 40,000, which is approximately 28 mm tall. This small size enables the miniature designers to craft most combatants in whole ranks or "strips"

that fasten to rectangular 20-mm x 40-mm bases or "stands." Warmaster models are cast in metal, and most are designed to fit onto the plastic bases supplied. A few large models require you to modify the bases or make your own from scratch. In order to distinguish character pieces, many players like to substitute the standard rectangular bases for round bases made from coins or washers. Infantry and cavalry units generally consist of three bases or stands as shown in this catalog. Some units consist of fewer stands, and most large monsters fit onto just one. In all cases, the model range has been designed so that you buy one whole unit at a time. The character sets include a variety of pieces including extra bitz (the designers like doing characters!) but always contain enough pieces to make at least one general, one hero, and one wizard stand. One exception is the Slann Mage-Priest for the Lizardmen. He's so fat that we had to put him in his own pack.



HOBBY SUPPLIES

A Vast Hobby

The majority of this massive catalog is taken up by page after page of the best miniatures ever produced, but of course, the hobby is bigger than the models. This section is dedicated to all the painting and hobby supplies that can help you get the most out of this fantastic hobby.

Painting

There is no denying the appeal of painting and painted models. There is an entire spectrum of painting – from exquisitely detailed models that can take weeks of work to complete to simple and clean basecoated soldiers pleasingly ranked up for battle. From contestants in the Golden Demon, the ultimate GW painting competition, to the more humble speed painter who just wants some color on his models for an upcoming battle, many types of hobbyists enjoy this exciting aspect of the hobby.

In this section, you will find the Citadel Colour line of water-based acrylic paints as well as brushes, spray primers, and more.

Modeling

In addition to cleaning up mold lines and preparing models to paint, some hobbyists like to convert models. A converter will hack off a bit here, add a bit there, and suddenly a unique figure or pose is created. New weapons, peg legs, battle scars, and all manner of new alterations can be made by the model converter to bring a unique piece to life. Even larger pieces, like tanks or Dragons, can really let a modeler go all out.

To aid the hobbyist in modeling, Games Workshop sells all manner of tools such as files and pin vises as well as essentials like glue and putty.

Diorama Making

Some hobbyists combine painting and modeling to create life-like dioramas that are striking to behold. A well-painted model looks even better in a realistic vignette – perhaps an Empire Knight entering the Drakwald forest or a Lictor waiting to spring onto an unsuspecting victim. A great diorama tells an interesting story and brings life to the models.

Terrain Making

Where are your armies going to fight? Nothing will make a wargamer yearn for battle like an evocative gaming table with interesting terrain.

It may start with simple hills, forests, or defensible emplacements, but soon the rich environments of Games Workshop's worlds will inspire a terrain builder to soar to new

heights – tightly packed hive cities, Dwarf mines, and more. Really inspirational high-end games like siege battles, city fights, underground warfare, or even starship boarding actions are the kind of scenarios that gamers dream of playing and require the kind of terrain that hobbyists aspire to design and create.

In this section, you will find some very useful tools for building terrain, like the wonder cutter as well as some great starter terrain like hills and trees.

Gaming

And the whole hobby swings back to gaming. Win or lose, the tactics, dice rolling, and

good-natured camaraderie of playing a tabletop wargame remains unmatched by any other experience. You'll find extra bases, movement trays, see-through templates for area effect weapons, and more to make your gaming experience fast and fun.

Painting & Hobby Supplies

It doesn't matter if you like all aspects of the hobby equally or if you only participate in one particular aspect, this section can add to your enjoyment. On the following page, we've wedged in loads of examples of tools in use, modeling techniques, and types of projects. Loads more can be found each month in *White Dwarf* magazine or on the GW web site.

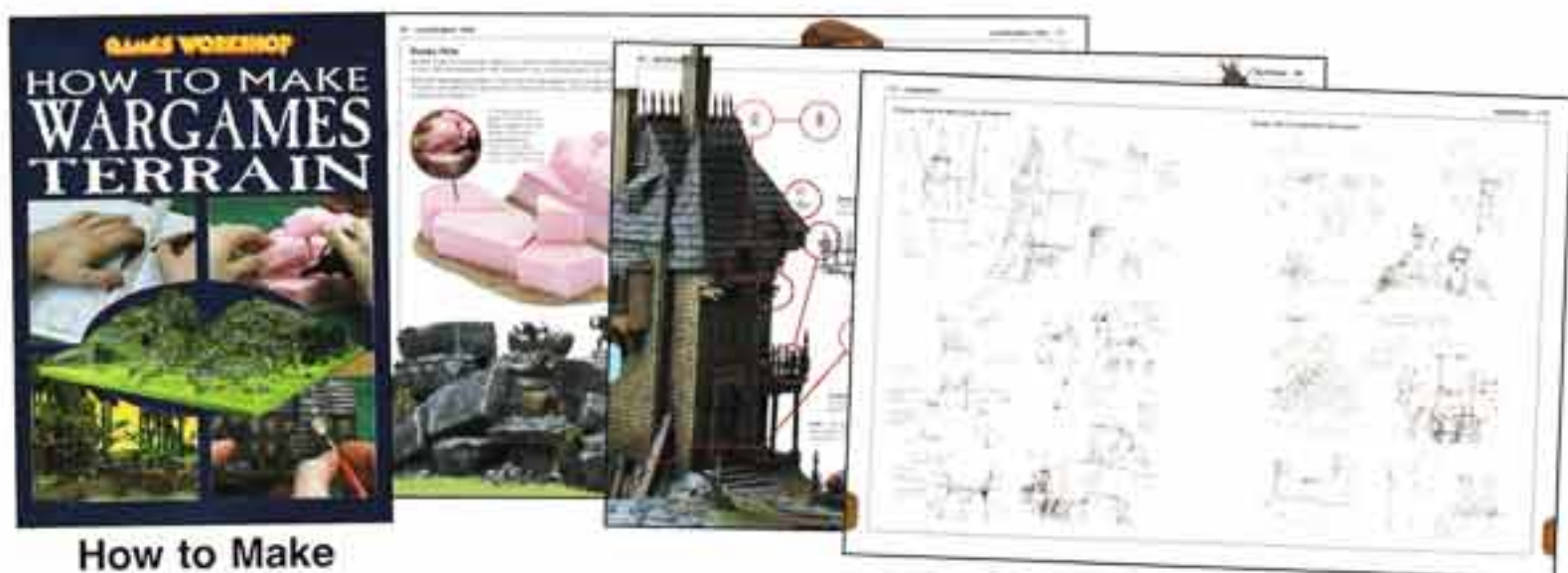

How to Make Wargames Terrain
60049999083



How to Paint Citadel Miniatures
60049999072



How to Paint Space Marines
60040101004

CITADEL COLOUR

Priming your models is an important step in painting. Primer provides a base to which your paints can easily adhere. Without primer, the paint job you worked so hard on will rub off as the models are handled and transported.

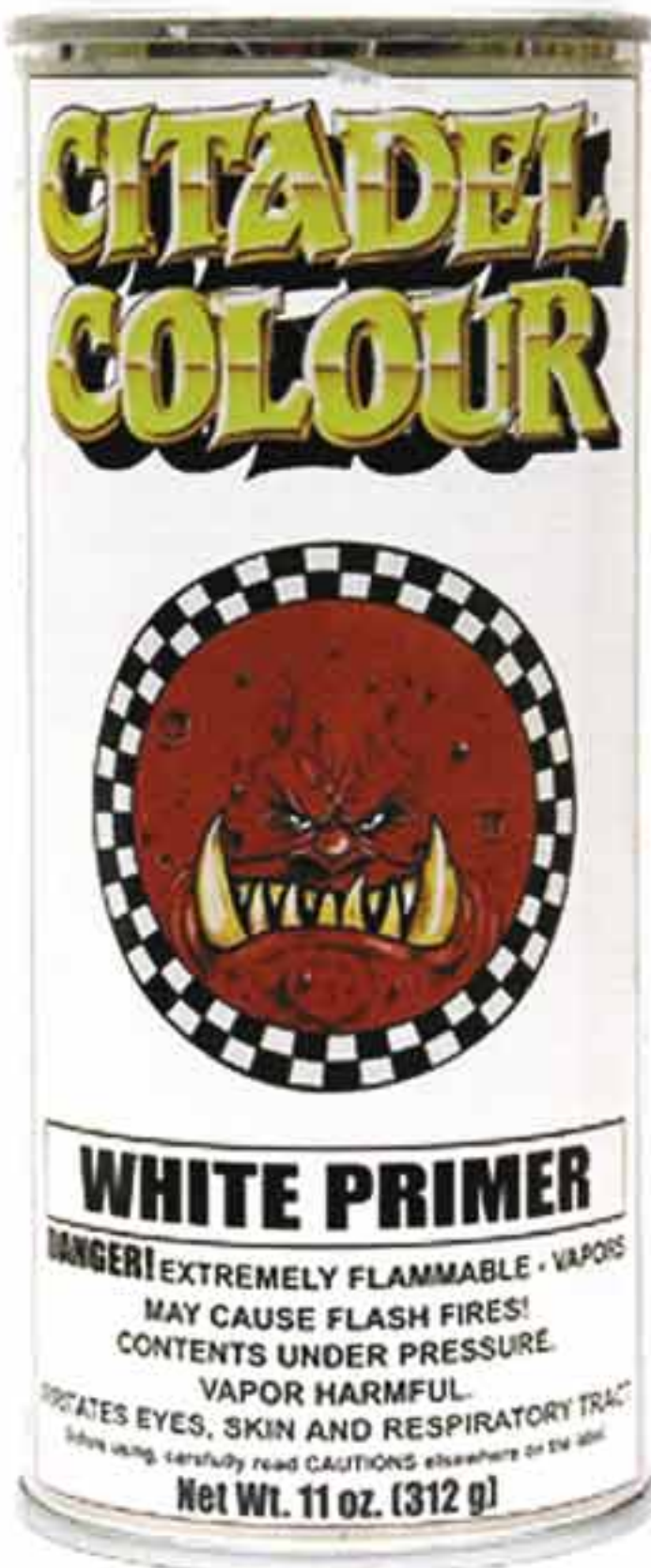

White Primer
13209999011



Black Primer
13209999012



Matte Varnish
13209999013



Bleached Bone Spray Paint
13209999014



Dark Angels Green Spray Paint
13209999015



Shadow Grey Spray Paint
13209999020



Blood Red Spray Paint
13209999021



Ultramarine Blue Spray Paint
13209999022



Boltgun Metal Spray Paint
13209999025

CITADEL COLOUR

CITADEL COLOUR PAINTS



SCAB RED
99189999101



RED GORE
99189999102



BLOOD RED
99189999103



BLAZING ORANGE
99189999104



FIERY ORANGE
99189999105



GOLDEN YELLOW
99189999106



SUNBURST YELLOW
99189999107



BAD MOON YELLOW
99189999108



SCORCHED BROWN
99189999109



BESTIAL BROWN
99189999110



SNAKEBITE LEATHER
99189999111



BUBONIC BROWN
99189999112



VOMIT BROWN
99189999113



BLEACHED BONE
99189999114



DARK FLESH
99189999115



VERMIN BROWN
99189999116



DWARF FLESH
99189999118



BRONZED FLESH
99189999119



ELF FLESH
99189999120



LICHE PURPLE
99189999124



WARLOCK PURPLE
99189999125



TENTACLE PINK
99189999126



MIDNIGHT BLUE
99189999127



REGAL BLUE
99189999129



ULTRAMARINES BLUE
99189999130



ENCHANTED BLUE
99189999131



ICE BLUE
99189999133



HAWK TURQUOISE
99189999134



DARK ANGELS GREEN
99189999135



SNOT GREEN
99189999136



SCORPION GREEN
99189999137



GOBLIN GREEN
99189999139



ROTTING FLESH
99189999140



CAMO GREEN
99189999141



SCALY GREEN
99189999142



SHADOW GREY
99189999145



SPACE WOLVES GREY
99189999146



CHAOS BLACK
99189999148



CODEX GREY
99189999149



FORTRESS GREY
99189999150



SKULL WHITE
99189999151



TERRACOTTA
99189999177



GRAVEYARD EARTH
99189999178



KOMMANDO KHAKI
99189999179



DESERT YELLOW
99189999180



CATACHAN GREEN
99189999181



TANNED FLESH
99189999176



GLOSS VARNISH
99189999174

METALLIC PAINTS



MITHRIL SILVER
99189999152



CHAINMAIL
99189999153



BOLGUN METAL
99189999154



TIN BITZ
99189999155



DWARF BRONZE
99189999157



BRAZEN BRASS
99189999158



BURNISHED GOLD
99189999159



SHINING GOLD
99189999160

CITADEL COLOUR

CITADEL COLOUR INKS



Mixing Pot (1)
99189999182



Games Workshop Paint Set
99179999003



Games Workshop Mega Paint Set
99179999004

Containing the entire range of Citadel Colour paints, the Mega Paint Set is something no serious hobbyist should be without. With PVA (white) glue to apply modeling flock and sand for enhancing your bases, a painting guide, brushes, and even empty pots to mix your favorite colors in, this kit is an invaluable and comprehensive resource for painting your armies.



Citadel Brush Set
99239999019





MODELING TOOLS



Pin Vise Drill Bits
99239999024



Craft Knife Blades
99239999023

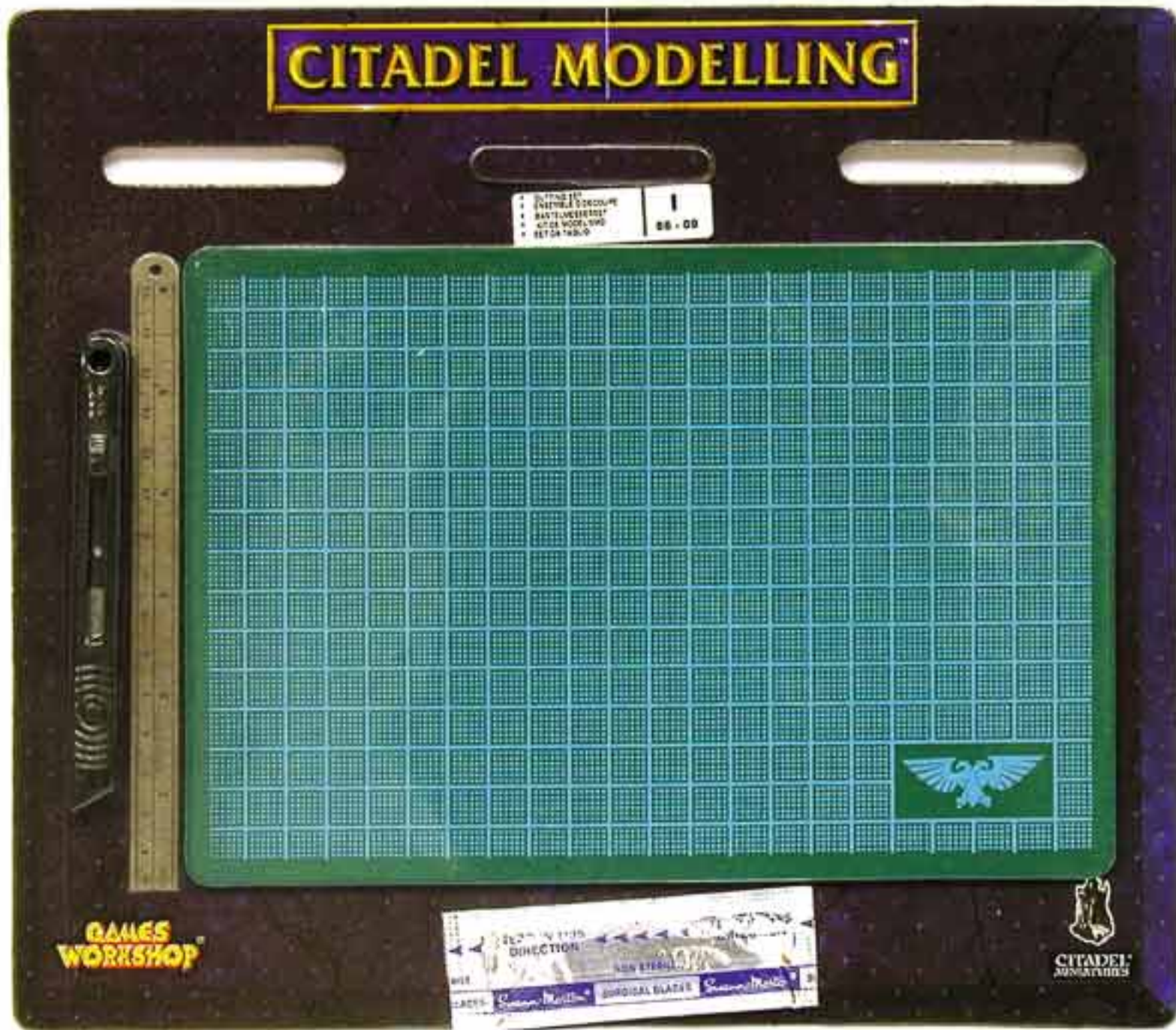

Cutting Set
99239999014



Saw & Blades
99239999013



Pin Vise Set
99239999010



Tweezers
99239999017

MODELING TOOLS



Painting Station
99239999018



Modeling Putty (Green Stuff)
99219999005



Hot Wire Tool
99239999012



Citadel Tape Measure
99239999009



Pliers
99239999016



Side Cutters
99239999008



File Set
99239999011



Sculpting Tool
99239999015





TERRAIN MATERIAL



Modeling Flock
99229999020

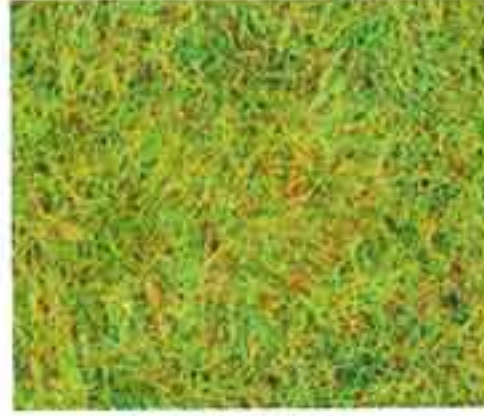

Static Grass
99229999021



Modeling Sand
99229999023



Modeling Gravel
99229999024



Hills
99229999048

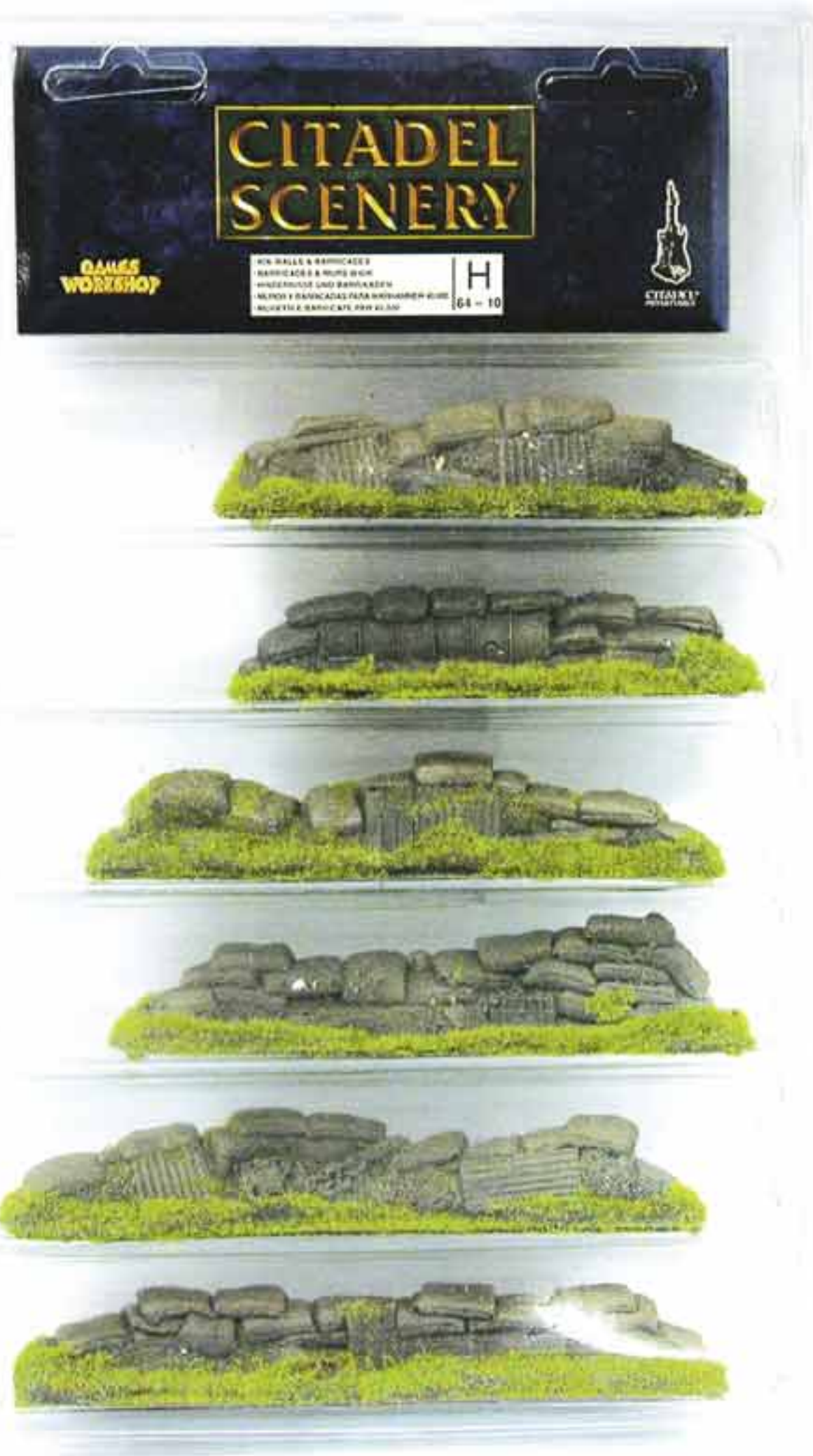

40K Walls & Barricades
99220199008



Hedges & Walls
99220299004

HOBBY EXTRAS



Woods
99229999027



Citadel PVA Glue
99219999006



Citadel Super Glue
13219999004



Citadel Plastic Glue
13219999011



Figure Case (1)
99239999007

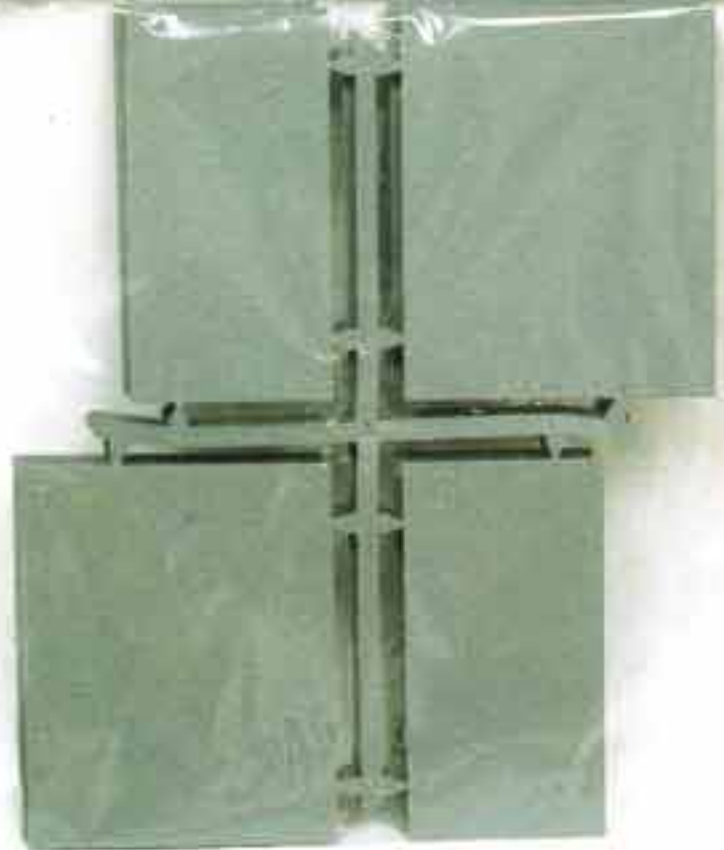

Movement Trays
99229999013

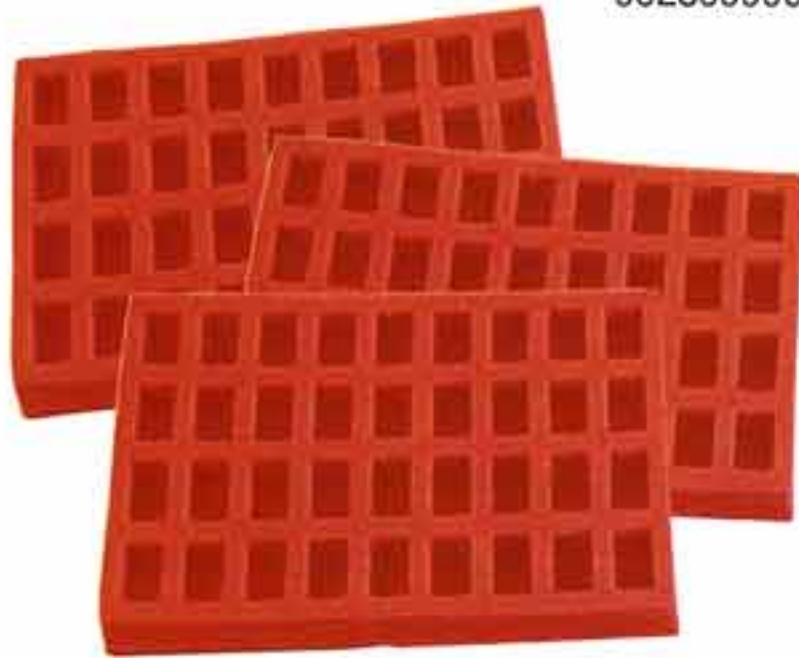

Figure Case Trays (3)
13239999009



Battle Dice
99229999051

All miniatures are supplied unpainted. Models, bits, and sprues are all shown actual size unless otherwise noted. Contents may vary slightly from those shown.



BASES



40mm Square Bases (16)
99229999031
BIT NAME: 40MM SQUARE BASE
BIT CODE: 99379999011



50mm Square Bases (15)
99229999035
BIT NAME: 50MM SQUARE BASE
BIT CODE: 99379999012



Cavalry Solid Base (1)
99379999015



Cavalry Bases (30)
99229999030
BIT NAME: CAVALRY BASE
BIT CODE: 99379999020



20mm Square Bases (60)
99229999034

BIT NAME: 20MM SQUARE BASE
BIT CODE: 99379999004

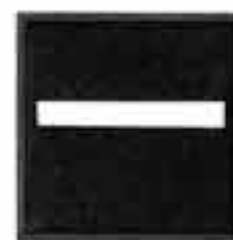

20mm Square Parallel Base (4)
99379999005



20mm Square Solid Base (4)
99379999007



Small Regiment Bases (15)
99229999039
BIT NAME: SMALL REGIMENT BASE
BIT CODE: 99379999021



25mm Square Bases (60)
99229999029

BIT NAME: 25MM BASE
BIT CODE: 99379999008



25mm Square Parallel Base (4)
99379999006



25mm Square Solid Base (4)
99379999019



Large Regiment Bases (15)
99229999038
BIT NAME: LARGE REGIMENT BASE
BIT CODE: 99379999022



Chariot Base (1)
99379999030

BASES



60mm Round Bases (15)
99229999043

BIT NAME: 60MM ROUND BASE
BIT CODE: 99370399001



40mm Round Bases (25)
99229999042

BIT NAME: 40MM ROUND BASE
BIT CODE: 99379999023



25mm Round Bases (56)
99229999033

BIT NAME: 25MM ROUND BASE
BIT CODE: 99379999009



25mm Round Solid Base (4)
99379999010



Note: The 60mm Round base 99370399001 is approximately 2mm thick, while the 60mm Round base 99379999031 is approximately 5mm thick.



60mm Round Base (1)
99379999031



60mm Dreadnought Base (1)
99390101008

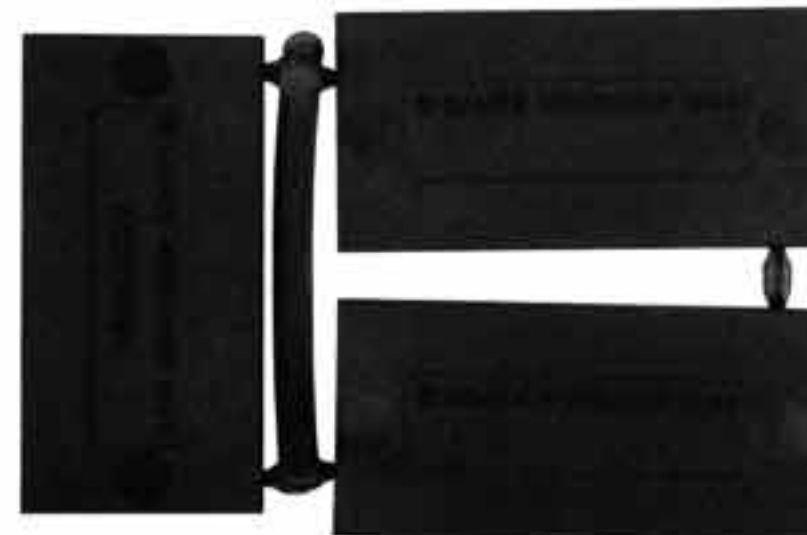

Warmaster Bases (3)
99371299001



LARGE FLYING BASE
99379999002

Large Flying Bases (16)
99229999036



LARGE FLYING STEM
99379999013

SMALL FLYING BASE
99379999014

SMALL FLYING STEM
99379999003

Small Flying Bases (12)
99229999032

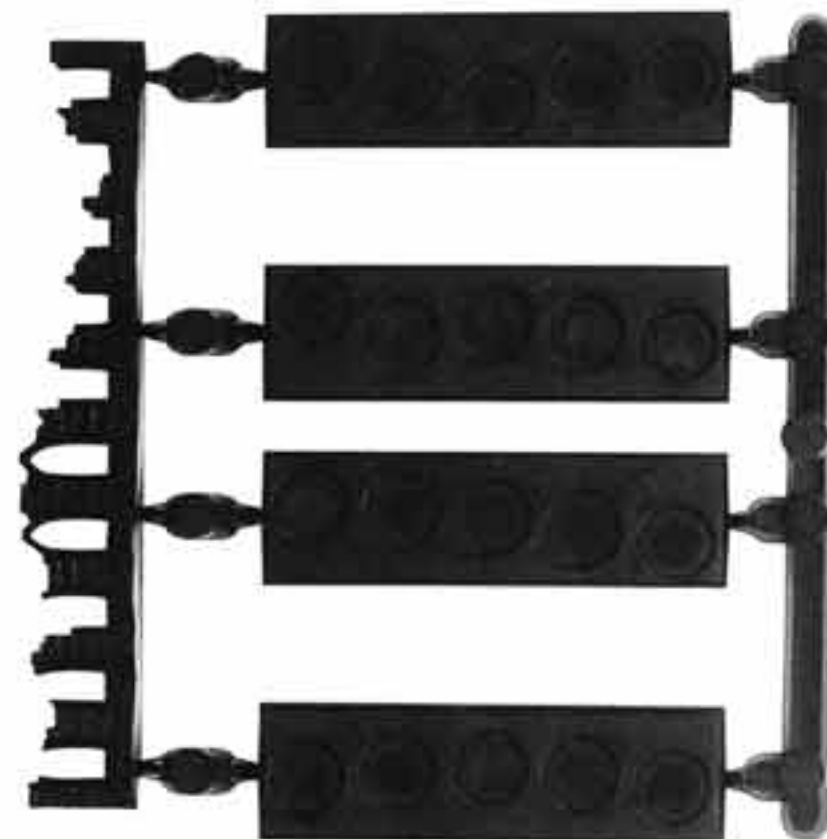

Epic Bases (4)
99379999016

DIRECT SERVICES

With our Direct Order Service, Games Workshop is only a phone call away. Whether you are ordering products, trying to get a customer service issue sorted out, or just asking a hobby question, give us a call. What else can our Direct Services department do for you? Read on...

What Can We Do for You?

The Direct Services Department at Games Workshop is here to serve you, the hobbyist. Here is what we can do for you.

Mail Order Service

All the products in the Complete Catalog are available to you through Direct Services. Just let us know what you'd like, and we'll get it shipped to you quickly and efficiently!

Customer Service Issues

Did your last order include a miscast model? Are you missing a shield off your plastic regiment sprue? Give us a call, and we'll tell you how we can get the problem solved!

Find the Store Nearest You

Supporting your local store is always a great idea. After all, where else are you going to go to play, join leagues, and trounce everyone with your army? Give us a call, and we can search the database for the shops nearest you. You can do this yourself on the internet, but should you be unable to reach the World Wide Web, we're glad to help.

Remember this handy feature next time you travel as well – what a great opportunity to check out some hot gaming spots on your next business trip, family outing, or vacation!

Subscribe

Lock in a year (or more) of *White Dwarf*!

Got Hobby Questions???

The members of our Direct Services staff are all hobbyists. They will be glad to explain to you what green stuff is (and why it is called that), how to get started with any of our games, or what troops qualify as Core in a Dark Elf army.

Each Hobby Specialist has right in front of him a huge stack of old issues of *White Dwarf* (what issue had the battle report of Guard vs...?) as well as all the latest rulebooks and army Codices. If we don't know the answer, we'll do our best to look it up for you.

Ordering from Direct Services

There are three easy and convenient methods you may use to order.

Call us at 1-800-394-GAME.

Fax us at 410-689-2330.

Order by mail (see address below).

Games Workshop accepts Visa, Mastercard, American Express, and Discover. When ordering by mail or fax, please be sure to include a complete mailing address where you would like your order shipped (including your phone number and e-mail address). When ordering by mail, Games Workshop accepts Checks and Money Orders.

Please note that Maryland and Virginia residents must add 5% tax.

Shipping & Handling

Orders may take up to 3 to 5 business days to arrive at any address in the continental US.

Games Workshop Shipping & Handling

Orders to \$20.00	\$6.50
\$20.01 to \$40.00	\$7.50
\$40.01 to \$60.00	\$8.50
\$60.01 to \$80.00	\$9.50
\$80.01 to \$100.00	\$10.50
\$100.01 to OVER	FREE!

P.O. Boxes, APO, FPO – Orders are sent via US Postal Service.

PR, AK, HI Orders are sent via UPS 2nd Day Service

ADDITIONAL SERVICES

Next Day Delivery – Add \$10.00.

Foreign Shipping Charges – Please call for details.

SPRAY PAINTS AND PRIMERS

Due to Federal regulations, no spray cans may be shipped via any form of air carrier. We can only send spray cans via ground service. This limits us to selling spray paints and primers to continental US and Canadian addresses only (NO P.O. Boxes).



Remember, Direct Services is the only way you can get models like the variant Space Marine Techmarine and the Ogre Kingdoms Maneater Ninja!

GAMES WORKSHOP

US DIRECT SERVICES INFORMATION

Phone: 1-800-394-GAME Fax: 1-410-689-2330

Call 7 days a week, 10:00 a.m. – 9 p.m. Monday through Sunday (Eastern)

Games Workshop Direct Services
6721 Baymeadow Drive
Glen Burnie, MD 21060-6401

ONLINE STORE

Open 24 hours a day, 7 days a week, the Games Workshop online store is stocked with everything Games Workshop sells. Whether you are looking for a conversion bit, a missing paint color, or a whole new army, shopping online with Games Workshop is safe, fast, and easy. From back issues of *White Dwarf* to new releases, the Games Workshop Online Store has it all.

Bitz Orders

Ordering individual bitz and components for conversions couldn't be easier! Wherever possible, each game, boxed regiment or model, and blister pack is broken down into component parts, each with its own code and price for easy individual purchase with just a few clicks of a mouse.

Advanced Orders & New Releases

These regularly updated sections are more complete than ever in the Online Store. You can see all the new cool jazz that GW is about to release and place pre-orders for up and coming items so that you can be the first one on your block with all the newest swag.

THE U.S. ONLINE STORE

Items: 000
View Cart
 Total: \$ 0.00
Postage: \$ 0.00

Home • Warhammer • Warhammer 40,000 • The Lord of The Rings • Specialist Games • White Dwarf • Hobby Supplies • Publications
Help New Releases Welcome Guest Advanced Orders Checkout

Welcome to the Games Workshop US Online Store

Search:

All Systems ▾

Begin Search

Store Sections:

- The Lord of The Rings
- Warhammer
- Warhammer 40,000
- Specialist Games
- White Dwarf
- Hobby Supplies
- Publications
- Events
- Classic/Collector's
- The Spotlight

History:

- Veterans
- Terminator
- Librarian

Wish List:

Click here to create a new Wish List.

New In The Online Store:

DEEP STRIKE!!!

SPACE MARINE TERMINATORS

Upcoming Events Now On Sale:

Games Day Baltimore - May 14

Games Day Chicago - July 30
Tickets go on sale April 25, 2005.

If you need more information about Games Day, make sure you check out the [2005 US Games Day web site](#).

White Dwarf:

Black Gobbo:

Newsletter:

Featured Item:

News and Announcements:

- Special Edition Miniatures are now available in [The Spotlight!](#)
- New to the Online Store? Take our [tutorial](#).
- Subscribe to [White Dwarf Magazine!](#)
- Do you have questions? Can't find information about shipping? Look for the answers in the [FAQ](#).
- Your search for older miniatures is over in our [Classic/Collector's](#) section of the Online Store!

Advanced Orders:

Warhammer Realms: Lustria

\$20.00

You can see and purchase all of our current Advanced Orders in the [Advanced Orders](#) section of the Online Store.

Symbol Key: Add to Cart More Info View Components Add to Wish List

[FAQ](#) [Security](#) [Contact Us](#) [Privacy Policy](#) [Terms and Conditions](#)
[GW US](#) [GW Canada](#) [GW Australia](#) [GW UK](#) [Specialist Games](#)

All models are supplied unpainted and may not include banners. Contents may vary from those shown. Models not shown to scale in all instances.

Copyright (c) Games Workshop Limited 2005 excepting all material pertaining to the New Line theatrical productions: *The Fellowship of the Ring*, *The Two Towers*, and *The Return of the King* which are (c) MMV New Line Productions, Inc. All Rights Reserved. *The Lord of The Rings*, *The Fellowship of the Ring*, *The Two Towers*, *The Return of the King* and the names of the characters, items, events and places therein are trademarks of The Saul Zaentz Company d/b/a Tolkien Enterprises under license to New Line Productions, Inc. and Games Workshop Ltd. All Rights Reserved. Games Workshop, the Games Workshop logo, Warhammer, the Warhammer 40,000 device, the Double Headed/Imperial Eagle device, 40k, GW, Easy Metal, Space Marine, the Space Marine Chapters, the Space Marine chapter insignia, Codex, White Dwarf, Citadel, Citadel Device, Khemri, Nurgle, Skaven, Slaanesh, Tomb Kings, Tzeentch, Chaos, the Chaos device, the Chaos logo, Ogre Kingdoms, Forge World, Khorne, the Khorne device, Kroot, Necron, Nurgle, the Nurgle device, Ork, Ork skull device, Slaanesh, the Slaanesh device, Tau, the Tau caste designations, Tyranid, Tzeentch, the Tzeentch device and all associated products, marks, logos, places, names, creatures, races and race insignia/devices/logos/symbols, factions, vehicles, locations, weapons, units, characters, illustrations and images from the Warhammer World and Warhammer 40,000 Universe are either ®, TM and/or © Games Workshop Ltd 2000-2005, variably registered in the UK and other countries around the world. All Rights Reserved.

THE U.S. ONLINE STORE

Items: 000
View Cart
 Total: \$ 0.00
Postage: \$ 0.00

Home • Warhammer • Warhammer 40,000 • The Lord of The Rings • Specialist Games • White Dwarf • Hobby Supplies • Publications
Help New Releases Welcome Guest Advanced Orders Checkout

White Dwarf: DEEP STRIKE!!!

SPACE MARINE TERMINATORS

Components

 \$ 1.00	 \$ 4.50	 \$ 7.00
 \$ 7.50	 \$ 1.50	 \$ 1.50
 \$ 1.50	 \$ 2.50	 \$ 2.50
 \$ 1.00		

Symbol Key: Add to Cart More Info View Components Add to Wish List

[FAQ](#) [Security](#) [Contact Us](#) [Privacy Policy](#) [Terms and Conditions](#)
[GW US](#) [GW Canada](#) [GW Australia](#) [GW UK](#) [Specialist Games](#)

All models are supplied unpainted and may not include banners. Contents may vary from those shown. Models not shown to scale in all instances.

Copyright (c) Games Workshop Limited 2005 excepting all material pertaining to the New Line theatrical productions: *The Fellowship of the Ring*, *The Two Towers*, and *The Return of the King* which are (c) MMV New Line Productions, Inc. All Rights Reserved. *The Lord of The Rings*, *The Fellowship of the Ring*, *The Two Towers*, *The Return of the King* and the names of the characters, items, events and places therein are trademarks of The Saul Zaentz Company d/b/a Tolkien Enterprises under license to New Line Productions, Inc. and Games Workshop Ltd. All Rights Reserved. Games Workshop, the Games Workshop logo, Warhammer, the Warhammer 40,000 device, the Double Headed/Imperial Eagle device, 40k, GW, Easy Metal, Space Marine, the Space Marine Chapters, the Space Marine chapter insignia, Codex, White Dwarf, Citadel, Citadel Device, Khemri, Nurgle, Skaven, Slaanesh, Tomb Kings, Tzeentch, Chaos, the Chaos device, the Chaos logo, Ogre Kingdoms, Forge World, Khorne, the Khorne device, Kroot, Necron, Nurgle, the Nurgle device, Ork, Ork skull device, Slaanesh, the Slaanesh device, Tau, the Tau caste designations, Tyranid, Tzeentch, the Tzeentch device and all associated products, marks, logos, places, names, creatures, races and race insignia/devices/logos/symbols, factions, vehicles, locations, weapons, units, characters, illustrations and images from the Warhammer World and Warhammer 40,000 Universe are either ®, TM and/or © Games Workshop Ltd 2000-2005, variably registered in the UK and other countries around the world. All Rights Reserved.

Whether you need a complete kit or a few bitz to finish a conversion, you can find it on the Online Store, any time of the day!

http://store.us.games-workshop.com

WWW.GAMES-WORKSHOP.COM 663

All miniatures are supplied unpainted. Models, bitz, and sprues are all shown actual size unless otherwise noted. Contents may vary slightly from those shown.

GW HOBBY CENTERS

Games Workshop Hobby Centers are springing up all over North America. They are the premier location to find everything associated with the Games Workshop hobby. If you haven't been to one yet, here's the scoop on just what they're all about.

Friendly & Expert Staff

Games Workshop Hobby Centers are staffed exclusively by hobbyists. Thus staff members are more than qualified to answer any of your questions about any of the following topics.

- gaming
- assembling your models
- painting
- choosing or building an army
- beating your buddy in a game
- terrain building
- model converting

Exactly What You Want

Games Workshop Hobby Centers are stocked with everything that is in the current range. They are at the forefront of all the new releases – if it is in the current range, you'll find it in our Hobby Centers.

In addition, you can visit our Hobby Centers to place special orders for models from older ranges and for Specialist Games, including any of the Special Offer items you can find throughout the catalog. Ask the staff to help you and to check on the availability of models from older ranges.

Every Level of Gaming

Games Workshop Hobby Centers have something for every level of gamer.

Introductory Games. We are always glad to teach newcomers how to play Warhammer, Warhammer 40,000, and The Lord of The Rings. Just walk in and ask us! Bring a friend or play against staff. It is an awesome and fun opportunity to give our games a test run.

Advanced Gaming. Our Hobby Centers have a wide variety of gaming events, from mega-battles to special veteran nights for more serious competitors. There are always tournaments, leagues, and campaigns that allow you to join in the fun.

If you are interested in any of the special events, just ask the staff about the next event and how you can get involved.

Painting Clinics

Lots of hobbyists are daunted by painting at first, but we've found that, with a little encouragement and a little advice, anyone can turn out nice looking paint jobs. Hobby Centers run formal Painting Clinics (ask for the hours), and staff members are always available for advice on brushwork!

Terrain Making

While anyone can attend the gaming events at our Hobby Centers and use our terrain, many hobbyists want to build their own gaming table but are daunted by the task. Stop by a Hobby Center and get some tips.



STORE LIST

Arizona

Arizona Mills
Tempe (480) 756-8759

California

Westfield Shoppingtown Santa Anita
Arcadia (626) 294-0510

Sunvalley Shopping Center
Concord (925) 609-9450

Glendale Galleria
Glendale (818) 242-4433

Northridge Fashion Center
Northridge (818) 993-0853

Ontario Mills
Ontario (909) 581-0001

The Block at Orange
Orange (714) 769-3189

Stoneridge
Pleasanton (925) 463-1481

Metreon
San Francisco (415) 369-6136

Westfield Shoppingtown Oakridge
San Jose (408) 226-6325

Pacific View
Ventura (805) 658-8924

Los Angeles HQ
Westminster (714) 893-7666

Colorado

Colorado Mills
Lakewood (303) 384-3534

Connecticut

The Shoppes at Buckland Hills
Manchester (860) 644-9333

Georgia

Arbor Place
Douglasville (770) 577-5599

Mall of Georgia
Buford (770) 904-0601

Illinois

Westfield Shoppingtown Fox Valley
Aurora (630) 585-9913

Chicago HQ
Downer's Grove (630) 426-0120

The Shoppes at Geneva Commons
Geneva (630) 232-2929

Gurnee Mills
Gurnee (847) 856-0885

Orland Square Shopping Center
Orland Park (708) 226-9563

Maryland

Westfield Shoppingtown Annapolis
Annapolis (410) 266-5667

The Festival at Bel Air
Bel Air (410) 569-7488

Glen Burnie HQ
Glen Burnie (410) 590-8675

Arundel Mills
Hanover (443) 755-1660

The Avenue at White Marsh
White Marsh (410) 933-2008

Massachusetts

Harvard Square
Cambridge (617) 864-0510

Liberty Tree Mall
Danvers (978) 646-9355

Holyoke Mall at Ingleside
Holyoke (413) 539-6974

Natick Mall
Natick (508) 653-3730

Michigan

Great Lakes Crossing
Auburn Hills (248) 454-7708

West Oaks II
Novi (248) 348-9433

Missouri

St. Louis Mills
Hazelwood (314) 227-5485

New Jersey

Cherry Hill Mall
Cherry Hill (856) 663-3303

Jersey Gardens
Elizabeth (908) 354-1500

New York

Walden Galleria
Cheektowaga (716) 651-9440

Forest Hills
Forest Hills (718) 263-7574

Greenwich Village
New York City (212) 982-6314

Upper East Side
New York City (212) 744-1390

Upper West Side
New York City (212) 362-0726

Carousel Center
Syracuse (315) 476-7786

Palisades Center
West Nyack (845) 348-1739

Pennsylvania

Franklin Mills
Philadelphia (215) 501-0230

Tennessee

Memphis HQ
Memphis (901) 541-7700

Opry Mills
Nashville (615) 514-3150

Texas

Grapevine Mills
Grapevine (972) 691-3744

Marq-E Houston
Houston (713) 957-9244

Rice Village
Houston (713) 526-2276

Willowbrook Plaza
Houston (281) 897-8600

Katy Mills
Katy (281) 644-6644

Virginia

Potomac Mills
Prince William (703) 492-4555

Stony Point Fashion Park
Richmond (804) 560-8030

Springfield Mall
Springfield (703) 719-9300

Washington

Supermall
Auburn (253) 288-3904

Seattle Bunker
Bellevue (425) 562-2300

Alderwood Mall
Lynnwood (425) 640-5155

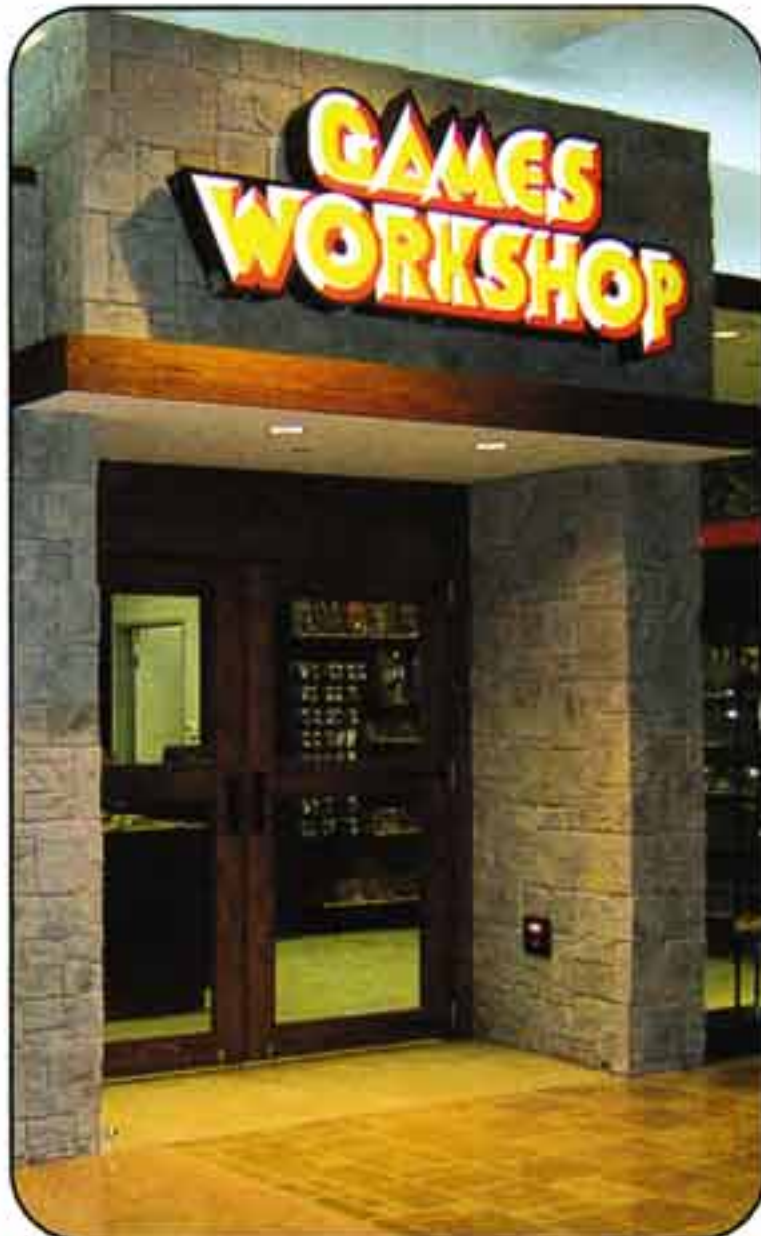

ROGUE TRADER RETAILERS

All across North America, hobbyists can find Independent Retail shops (also called Rogue Trader stores) that carry Games Workshop products. Your local shop isn't only a place to purchase your games and miniatures but also a place to play some games and befriend new opponents. Some Rogue Trader stores even run tournaments, leagues, painting clinics, and more.



Above: A complete, up-to-date list of stores in North and South America is included in every other issue of White Dwarf magazine. No matter where you are on either continent – Tukwila, Washington, or Paducah, Kentucky, or Santiago, Chile – you can use this list to find local hobby shops that carry GW products.

Finding a Rogue Trader

There are several ways to find Independent Retailers close to your home.

- Every odd-numbered issue of *White Dwarf* magazine contains a Retailer List. This insert lists every Rogue Trader & Hobby Center by state. From Alaska to Hawaii to everywhere in the continental U.S., you can find the shops near you.
- The Games Workshop web site has a great Store Locator. Under "Shopping" there is a link to FIND A STORE NEAR YOU. Type in your address, and you can get a listing of stores within 50 miles of your home as well as phone numbers, driving directions, and more.
- Call our Mail Order number at 1-800-394-GAME and tell them you are trying to find a store in your area.

Rogue Traders Can Carry the Entire Catalog!

No matter how large or small a Rogue Trader shop is, it can carry the entire line of games and miniatures featured in this catalog. In addition, any models from older ranges and from the Specialist Games range can be special ordered through the Rogue Trader. Just tell a staff member at your local shop that you are interested in these extended ranges, and he or she will check on availability and help you place your order. It's easy!!!

Find Your Local Hot Spot!

Finding a game shop with events is awesome and can be topped only by getting involved with a regular gaming group. Many Independent Retailers have one or more such groups that regularly attend gaming nights. Often, these groups run their own events. Stop by and ask a staff member when the next battle is and how you can get involved. If, by chance, your local Rogue Trader doesn't have a lot of gaming opportunities, perhaps you can offer to organize a regular game night? After all, anyone with an army or an urge to play is probably waiting for the same thing!

Right: Jeff Mitchell's Grey Knights won Best Unit at the World of Battle RTT painting competition.

Below: Dustin Wagster's entries in the World of Battle RTT painting competition and the RTT Trophies.

RTT Events

An RTT Event is an officially sanctioned GW event that stores, conventions, and clubs can run. These events can include tournaments, gaming leagues, and painting competitions and give local gamers a chance to pit their armies against others' forces in a competitive but fun atmosphere. In tournaments, players are judged not just by wins and losses but also on sportsmanship and painting. Everyone gets to play. While everyone may not take home an award, having fun is a victory in itself. You can find out who is having an RTT event near you by looking under the Events section online or by checking out *White Dwarf*.



GAMES DAY



Every year, a dedicated central team and hundreds of staff and volunteers in the field strive hard to bring you, the Games Workshop hobbyist, the finest in participation events.

Locations

In order to spread the celebration of the Hobby to as many folks as possible, we'll be running FOUR Games Days across the country in 2005. For details of each event, head to the Games Day web site:

gamesday.us.games-workshop.com

Celebration of the Hobby!

Whether you just started painting miniatures or you've been wargaming for decades, Games Day has something exciting to offer everyone.

- Registered gaming, club gaming, open gaming, mega-battles, introductory gaming, and tournaments – every kind of gaming you could hope for, all over evocative battlefields.
- Wacky speed painting, introductory painting, structured painting clinics, and the pinnacle of painting achievement, the Golden Demon painting competition. Each of these activities can inspire and improve your own artistic endeavors.
- Tons of special guests, including many from our own US Design Studios on hand to answer all of your questions about new releases, exciting projects, and even how to build many of the fantastic pieces you see in *White Dwarf* and *Black Gobbo* every month!



Games Day packs a wide array of Games Workshop experiences into one massive event! You can do things like learn modeling and scenery from the experts, check out the amazing entries in the Golden Demon Painting Competition, and play in large-scale games on incredible tables!

Below: Ben Bishop's Slayer-Sword-winning interpretation of Ariel from Chicago Games Day 2004





WHITE DWARF

Every month, *White Dwarf* magazine strives to pack, wedge, cram, and sledgehammer as much hobby material as possible into each issue. If you enjoy playing Games Workshop games or painting and converting Citadel Miniatures, then we have the magazine for you!

What You Can Expect from White Dwarf

- Photos of all the latest models painted exquisitely by the world-class 'Eavy Metal Painters.
- Updates & clarifications on the rules from the Games Designers themselves.
- Scads of suggestions for new ways to play, from warbands, to scenarios, to Kill Teams, to campaigns, to leagues, to mini-games.
- Hobby news, like dates for upcoming Grand Tournaments, Games Days, world-wide campaigns, events, and more!
- The best hobby tips anywhere from step-by-step painting instructions, to how to build terrain articles, to more modeling and converting advice than you can swing a dead Snotling at (not that we condone Snotling swinging, dead or alive!).

Just think – you can have all this delivered to your door every month!

Sign up for a *White Dwarf* subscription today!

Improve Your Tactics!

Each month, *White Dwarf* also contains at least one Battle Report, the chronicles of a bitter clash on the tabletop. Not only are these reports entertaining to read, but keen tacticians will be able to glean much from others' successes (and failures!).



White Dwarf Magazine Subscription

I would like to subscribe to *White Dwarf* for 1 year (12 issues) for \$60 US!

Mailing in the US:

Games Workshop Mail Order
6721 Baymeadow Drive
Glen Burnie, Maryland
21060-6401

Maryland and Virginia residents add 5% sales tax.

SUBSCRIBE TODAY AND GET 12 ISSUES FOR THE PRICE OF 10!

Name: Date of Birth:

Address:

City: State/Province: Zip/Postal Code:

Home Phone: Work Phone:

Method of Payment: Money Order Check Mastercard Visa Amer. Express Discover

Card Number: Expiration Date: /

Cardholder Name:

Cardholder Signature:

Offer expires January 1, 2006. Feel free to photocopy this form.

The Complete Catalog & Hobby Reference 2005-2006

GAMES WORKSHOP ONLINE

The Games Workshop web site is a living extension of this Complete Catalog. Online, you can find all the latest news, new releases, and more. Beginning players will discover massive amounts of background and hobby information, while even the most grizzled veteran will find the new articles of the Black Gobbo E-zine interesting, just like hidden chapters of White Dwarf magazine.

www.games-workshop.com

Find It on the Web!

- Find the Independent Retail shop or Games Workshop Hobby Center nearest you! Discover who is running events in your area! After all, having an army with no opponents to battle isn't much good.
- Read FAQs from the designers themselves for Warhammer and Warhammer 40,000.

- Read background and getting started information for EVERY Warhammer and Warhammer 40,000 army!
- See color schemes, step-by-steps, and tips for both beginners and experts to improve brushwork, speed, and results.
- Learn hobby news, like dates for upcoming Grand Tournaments, Games Days, worldwide campaigns, events, and more!
- Delve into a vast library of terrain projects. All sorts of how-to-build articles complete with step-by-step photos and more – from Tau escape pods to mutated Chaos Trees.
- Take part in periodic worldwide campaigns. While not always running, these gigantic events let everyone battle it out and log in and track the efforts of their allies and foes. The results help reshape the gaming worlds!



GAMES WORKSHOP
of Items: 0 Total: \$ 36 - CHECKOUT

BLACK GOBBO

Home · News · Black Gobbo · Games · Shopping · Community
Welcome Guest [Login Here](#)

CURRENT ISSUE

Black Gobbo Issue #36

- Black Gobbo Sez
- Evil Zombie Tree
- Game Accessories
- Campaign Tokens
- Against the Ogres Battle Report Part 1
- The Amber Prison

Previous Issue

Archive Issues

Search for Articles

What Is Black Gobbo?

Black Gobbo E-mail Notification:

E-mail Address:

Contacting Us:

e-mail: blackgobbo@games-workshop.com

Mail: blackgobbo@games-workshop.com
 c/o Games Workshop
 6721 Baymeadow Drive
 Glen Burnie, MD 21060

BLACK GOBBO

3.29.2005 – Black Gobbo Issue 36

Welcome to the BLACK GOBBO!

Summer is only a few short months away, so it's time to start thinking about [Warhammer campaigning](#). This issue of *Black Gobbo* helps you take your first steps toward fun in the Lustrian sun.

BUILD YOUR OWN EVIL ZOMBIE TREE

In the darkest jungles of Lustria lies a tree of unspeakable horror. This plant-beast snares any unfortunates who get too close and turns them into its mindless servants, destined to serve as both guards and food collectors. Rick Smith shows you how to build this evil Zombie tree.

ARBOR DAY OF DARKNESS

[Modeling Gameplay Accessories](#)

Warhammer Accessories
 You've got your army built, models painted, and scenery constructed. Now what? Ken Kennedy shows you how to make a few accessories that will make your games more fun.

[Updated Campaign Tokens](#)

Warhammer Tokens
 Map-based campaigns make for really fun games of Warhammer by placing your tabletop struggles in context. Here, we give you updated Warhammer tokens for your campaign maps.

- ## What Is Black Gobbo?
- Black Gobbo* is the name of the E-zine that is posted every 2 weeks on the Games Workshop U.S. web site. Each "issue" is loaded with new articles about all aspects of the hobby. Below are some types of articles that you can expect to find in each issue of *Black Gobbo*.
- Great previews of upcoming new models, games, Codices, and Army books.
 - Advanced gaming tactics that delve into questions like how to win with a certain army or how to get the most out of a particular troop type.
 - Lots of great painting examples, from different Space Marine Chapters to realistically filthy Mordor Orcs.
 - New scenarios and campaigns to challenge you and your gaming buddies.
 - Lots of great tips and step-by-step instructions on how to assemble your models, from the newest plastic kit to the oldest models in the GW archive.
 - Conversion tips and instructions. At some point every hobbyists wants to convert a model. *Black Gobbo* will show you how.
 - Terrain building tips from some of the best scenery designers and makers in the world.

GAMES WORKSHOP

COMPLETE CATALOG & HOBBY REFERENCE

IT'S ALL HERE

Almost all the models in the current range, along with their respective bitz, are on display here! In addition, we've managed to squeeze in all sorts of useful introductory information and hobby projects for every game and army. There's never been a more complete display of the entire Games Workshop World of Hobby Games. Dig in and enjoy!

WARHAMMER



WARHAMMER 40,000



THE LORD OF THE RINGS STRATEGY BATTLE GAME



CITADEL MODELLING



*The complete model ranges for Specialist Games are not shown in this catalog.

A PUBLICATION OF

GAMES WORKSHOP

www.games-workshop.com



NEW LINE CINEMA
A Time Warner Company



CITADEL
MINIATURES

Copyright © Games Workshop Limited 2005 excepting all materials pertaining to the New Line theatrical productions: The Fellowship of the Ring; The Two Towers; and The Return of The King which are © MMV New Line Productions, Inc. All Rights Reserved. The Lord of The Rings, The Fellowship of The Ring, The Two Towers, The Return of The King and the names of the characters, items, events and places therein are trademarks of The Saul Zaentz Company d/b/a Tolkien Enterprises under license to New Line Productions, Inc. All Rights Reserved. Games Workshop, the Games Workshop logo, Eavy Metal, Citadel and the Citadel device are either ®, TM and/or © Games Workshop Ltd 2000-2005, variably registered in the UK and other countries around the world. All Rights Reserved.

ISBN: 1-84154-598-8

SALES CODE: 98-51H

PRODUCT CODE:
13049999002

HARDBACK EDITION



5 011921 912247