

CITADEL MINIATURES

1999 ANNUAL



CITADEL
MINIATURES

GAMES
WORKSHOP

CITADEL[®] MINIATURES

1999 ANNUAL

Games Workshop, the Games Workshop logo, Citadel, the Citadel logo, Blood Bowl, Dark Angels, Deathwing, 'Eavy Metal, Eldar, Epic, Genestealer, Marauder, Slottabase, Space Hulk, Space Marine, Tyranid and Warhammer are all registered trademarks of Games Workshop Ltd.

Abaddon, Adepta Sororitas, Adeptus Mechanicus, Aekold Helbrass, Ahriman, Alcatani, Al Muktar, Annihilator, Anvil of Doom, Arbaal, Archaon, Asarnil, Aspect Warrior, Avatar, Azazel, Bad Moon, Baneblade, Baron Odo D'Outremer, Battle Fortress, Beorg Bearstruck, Bestigor, Big Boss, Big Grabber, Biovore, Black Ark Corsair, Blood Angels, Blood Axe, Blood Claws, Bloodletter, Bloodthirsters, Blue Horror, Borgio the Besieger, Bretonnian, Cadian, Callidus, Canoness, Carnifex, Catachan, Catrazza, Cawdor, Chaos Spawn, Cold One, Commissar Yarrick, Confessor, Culexus, Dactylis, Daemonette, Dark Eldar, Dark Reaper, Death Company, Deathskull, Deathstrike, Dechala, Delaquer, Deth Copter, Dieter Helsenicht, Digga, Digganob, Dire Avenger, Dragon Ogre, Dragon Prince, Dreadnought, Egrimm van Horstmann, Ellyrian Reaver, Eversor, Evil Sunz, Exarch, Exocrine, Fabius Bile, Falcon Gravitank, Farseer, Fighta Bommer, Fire Dragon, Flamer, Flesh Hound, Frateris Militia, Gargant, Ghazghkull, Glade Guard, Glade Rider, Gobbo, Goff, Golgfag, Goliath, Gorkamorka, Gorthor, Great Unclean One, Gretchin, Grey Hunters, Grey Knight, Grot, Gyrocopter, Haemonculus, Harridan, Haruspex, Heinrich Kemmler, Hellhound, Hierodule, Hierophant, Hive Tyrant, Hormagaunt, Howling Banshee, Huron Blackheart, Immolator, Imperial Guard, Joseph Bugman, Jules le Jongleur, Keeper of Secrets, Khârn the Betrayer, Khazrak, Khorne, King Kazador, Knights of the Blazing Sun, Knights of the White Wolf, Knights Panther, Kragg the Grim, Kroxigor, Land Raider, Land Speeder, Leman Russ, Leopoldo di Lucci, Lictor, Lifta Droppa, Lightning Claw, Long Beard, Long Drong Slayer, Long Fangs, Lord of Change, Lorenzo Lupo, Lothorn Seaguard, Louen Leoncoeur, Lucrezia Belladonna, Lugga, Luka Braganza, Madboy, Mandrake, Marneus Calgar, Maximillian Damark, Mekaniak, Mekboy, Miragliano, Missionary, Morathi, Mordian, Mydas the Mean, Nagash, Necromunda, Necrons, Night Goblin, Night Spinner, Night Wing, Nob, Noise Marine, Nurgle, Nurgling, Ogryn, Orlock, Ork, Painboy, Phantom Titan, Phoenix Guard, Pink Horror, Pirazzo, Plague Bearer, Plague Marine, Predator, Psyker, Pulsa, Ratling, Ratskin Renegade, Ravager, Razorback, Reaver Battle Titan, Redemptionist, Repanse de Lyonesse, Revenant Titan, Rhino, Ricco's Republican Guard, Ripper Swarm, Rokkit Buggy, Rough Riders of Attila, Runtherd, Salamander, Sanguinius, Saurus, Scavvy, Scorcher, Scourge, Scyla, Seraphim, Shadowword, Shadow Warrior, Silver Helm, Sisters of Battle, Sister Superior, Skaven, Skink, Slann, Slaanesh, Smasha Gun, Snakebite, Sneaky Git, Snotling, Space Wolves, Spanner, Speedsta, Splatta Kannon, Spore Mine, Spyrer, Squig, Squiggoth, Stormboy, Stormvermin, Striking Scorpion, Sullman le Sorcerer, Swooping Hawk, Swordmasters of Hoeth, Sybarite, Tallarn, Teclis, Termagant, Terminator, Terradon, Thousand Sons, Thunderbolt, Thunderer, Thunderhawk Gunship, Titan, Traktor Kannon, Tristan le Troubadour, Troll Slayer, Trygon, Tyrion, Tzeentch, Ultramarines, Ungor, Ungrim Ironfist, Unks, Valhalla, Vespero, Vindicare, Vindicator, Voland's Venators, Vyper, War Buggy, Wardancer, Wartrak, Warhound Scout Titan, Warlord Titan, Warphead, Warp Spider, Wave Serpent, Waywatcher, Weirdboy, Whirlwind, White Dwarf, White Lions of Chrace, Witch Elf, Wraithguard, Wych, Yoof and Zoanthrope are all trademarks of Games Workshop Ltd.

All artwork in all Games Workshop products and the images contained therein have been produced either in-house or as work for hire. The copyright in the artwork and the images it depicts is the property of Games Workshop Ltd.

© Copyright Games Workshop Ltd, 1998. All rights reserved.

British Library Cataloguing-in-Publication Data. A catalogue record for this book is available from the British Library.



ISBN: 1 869893 66 2

Component Code: 60 31 99 99 011

UK
GAMES WORKSHOP LTD.
WILLOW ROAD,
LENTON,
NOTTINGHAM NG7 2WS

US
GAMES WORKSHOP INC.
6721 BAYMEADOW DRIVE,
GLEN BURNIE,
MARYLAND, 21060-6401

AUSTRALIA
GAMES WORKSHOP,
23 LIVERPOOL STREET,
INGLEBURN,
NSW 2565

CANADA
GAMES WORKSHOP,
1645 BONHILL ROAD,
UNITS 9-11, MISSISSAUGA,
TORONTO L5T 1R3

ITALY
GAMES WORKSHOP
WILLOW ROAD,
LENTON,
NOTTINGHAM NG7 2WS

SPAIN
GAMES WORKSHOP SL
MOTORES, 300-304, POL. GRAN VIA
SUR, 08908 HOSPITALET DE
LLOBREGAT, BARCELONA, ESPANA

GERMANY, GAMES WORKSHOP
DEUTSCHLAND,
UNIT 1, GLAISDALE POINT,
GLAISDALE INDUSTRIAL ESTATE
BILBOROUGH, NOTTINGHAM NG8 4GF

HONG KONG
GAMES WORKSHOP,
20TH FLOOR, LEADER CENTRE,
37 WONG CHUK HANG RD,
HONG KONG

Important

Not recommended for children under 8 years due to small parts and essential pointed components. Citadel Miniatures are fine scale models designed for gamers and collectors.

GAMES WORKSHOP[®]

CONTENTS

WARHAMMER 40,000	
SPACE MARINES	04
DARK ELДАР	49
TYRANIDS	57
ELDAR	67
CHAOS SPACE MARINES	86
IMPERIAL GUARD	102
SPACE ORKS	137
SISTERS OF BATTLE	148
HEROES OF THE IMPERIUM	152
GORKAMORKA	163
NECROMUNDA	184
EPIC 40,000	
SPACE MARINES	210
TYRANIDS	217
ELDAR	224
CHAOS SPACE MARINES	232
IMPERIAL GUARD	234
SPACE ORKS	243
WARHAMMER	
BRETONNIA	254
CHAOS	275
DARK ELVES	324
DOGS OF WAR	338
DWARFS	358
EMPIRE	374
HIGH ELVES	394
LIZARDMEN	416
ORCS & GOBLINS	430
SIEGE	462
SKAVEN	470
UNDEAD	483
WOOD ELVES	496
BLOOD BOWL	514

INHALT

WARHAMMER 40,000	
SPACE MARINES	04
DARK ELДАР	49
TYRANIDEN	57
ELDAR	67
CHAOS SPACE MARINES	86
IMPERIALE ARMEE	102
SPACE ORKS	137
ADEPTUS SORORITAS	148
HELDEN DES IMPERIUMS	152
GORKAMORKA	163
NECROMUNDA	184
EPIC 40,000	
SPACE MARINES	210
TYRANIDEN	217
ELDAR	224
CHAOS SPACE MARINES	232
IMPERIALE ARMEE	234
SPACE ORKS	243
WARHAMMER	
BRETONIA	254
CHAOS	275
DUNKELELFEN	324
SÖLDNER	338
ZWERGE	358
IMPERIUM	374
HOCHELFEN	394
ECHSENMENSCHEN	416
ORKS & GOBLINS	430
FESTUNGEN	462
SKAVEN	470
UNTOTE	483
WALDELFEN	496
BLOOD BOWL	514

CONTENIDO

WARHAMMER 40,000	
MARINES ESPACIALES	04
ELDARS OSCUROS	49
TIRÁNIDOS	57
ELDARS	67
MARINES ESPACIALES DEL CAOS	86
GUARDIA IMPERIAL	102
ORKOS	137
HERMANAS DE BATALLA	148
HÉROES DEL IMPERIO	152
GORKAMORKA	163
NECROMUNDA	184
EPIC 40,000	
MARINES ESPACIALES	210
TIRÁNIDOS	217
ELDARS	224
MARINES ESPACIALES DEL CAOS	232
GUARDIA IMPERIAL	234
ORKOS	243
WARHAMMER	
BRETONIA	254
CAOS	275
ELFOS OSCUROS	324
MERCENARIOS	338
ENANOS	358
EL IMPERIO	374
ALTOS ELFOS	394
HOMBRES LAGARTO	416
ORCOS Y GOBLINS	430
ASEDIO	462
SKAVENS	470
NO MUERTOS	483
ELFOS SILVANOS	496
BLOOD BOWL	514

CONTENUTO

WARHAMMER 40,000	
SPACE MARINE	04
ELDAR OSCURI	49
TIRANIDI	57
ELDAR	67
CAOS SPACE MARINE	86
GUARDIA IMPERIALE	102
ORKI	137
LA SORELLANZA	148
EROI DELL'IMPERIUM	152
GORKAMORKA	163
NECROMUNDA	184
EPIC 40,000	
SPACE MARINE	210
TIRANIDI	217
ELDAR	224
CAOS SPACE MARINE	232
GUARDIA IMPERIALE	234
ORK	243
WARHAMMER	
BRETONNIA	254
CAOS	275
ELFI OSCUR	324
MERCENARI	338
NANI	358
IMPERO	374
ELFI ALTI	394
UOMINI LUCERTOLA	416
ORCHETTI E GOBLIN	430
ASSEDIO	462
SKAVEN	470
NONMORTI	483
ELFI SILVANI	496
BLOOD BOWL	514

WARHAMMER®

40,000



SPACE MARINES®

PLASTIC SPACE MARINES

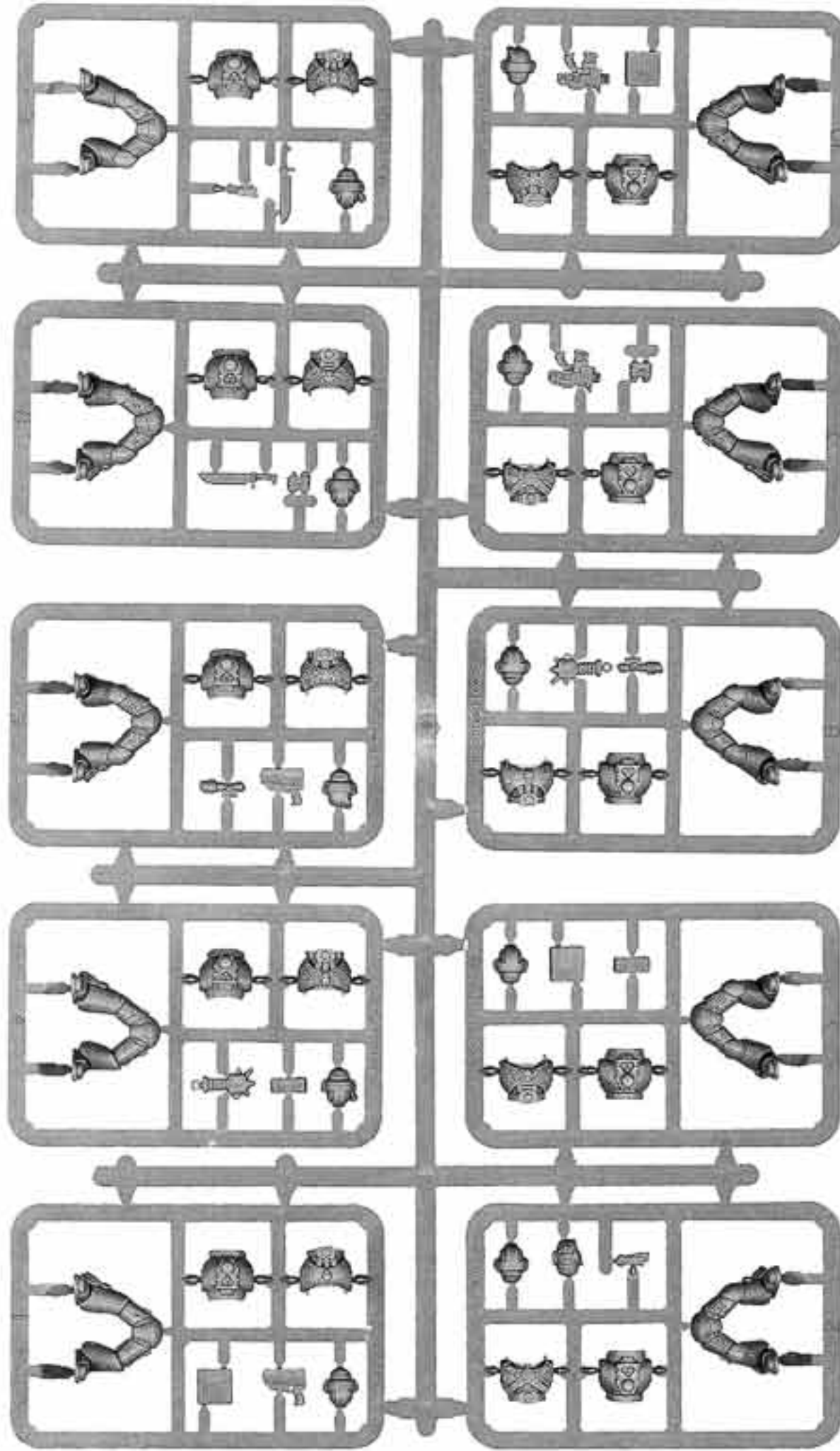

SPACE MARINE MAIN BODY SPRUE (SHOWN AT 55% OF ACTUAL SIZE)
99380101006



Designed by Jes Goodwin

Not suitable for children under 8 years due to small parts and essential pointed components. All models supplied unpainted.
© Copyright Games Workshop Ltd. 1998. All rights reserved.

SPACE MARINES®

PLASTIC SPACE MARINES

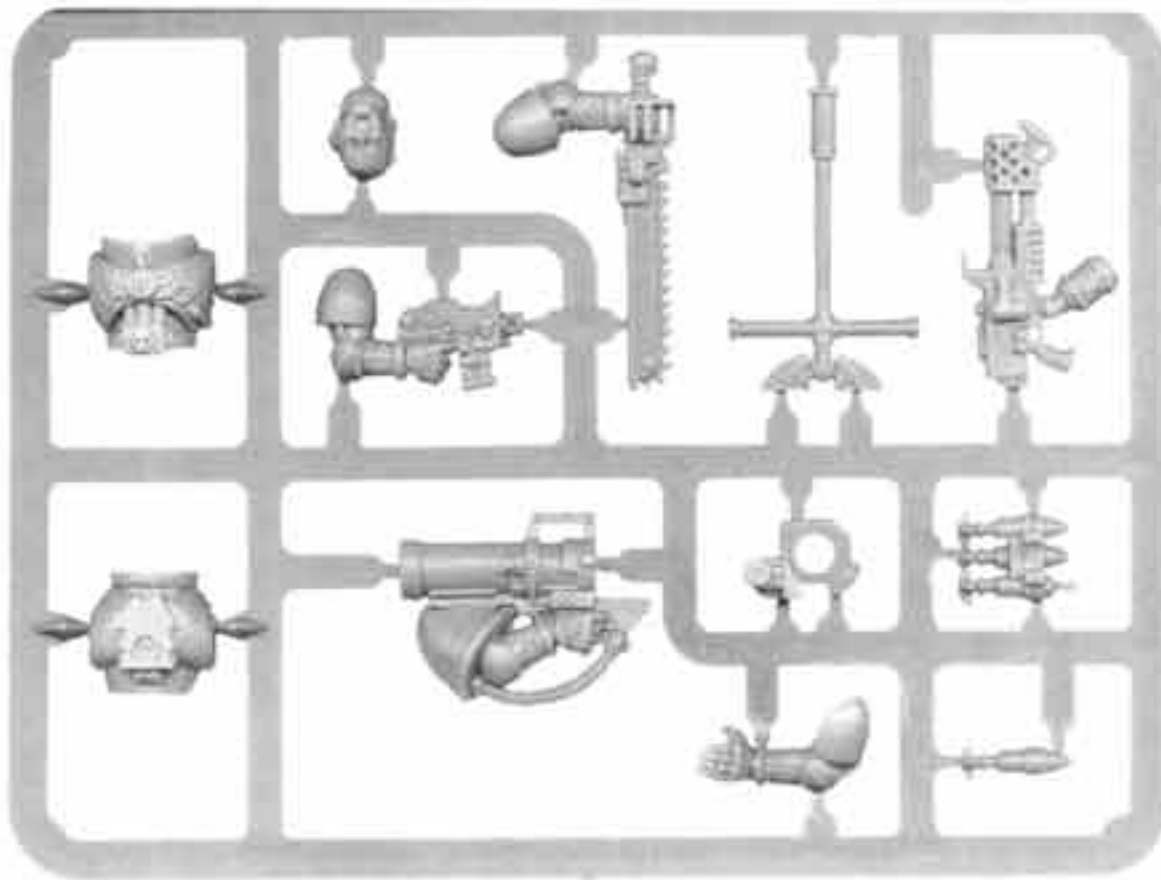

SPACE MARINE SPECIAL ACCESSORY SPRUE
99380101007



PLASTIC SPACE MARINES



SPACE MARINE BACK PACK SPRUE
99380101004

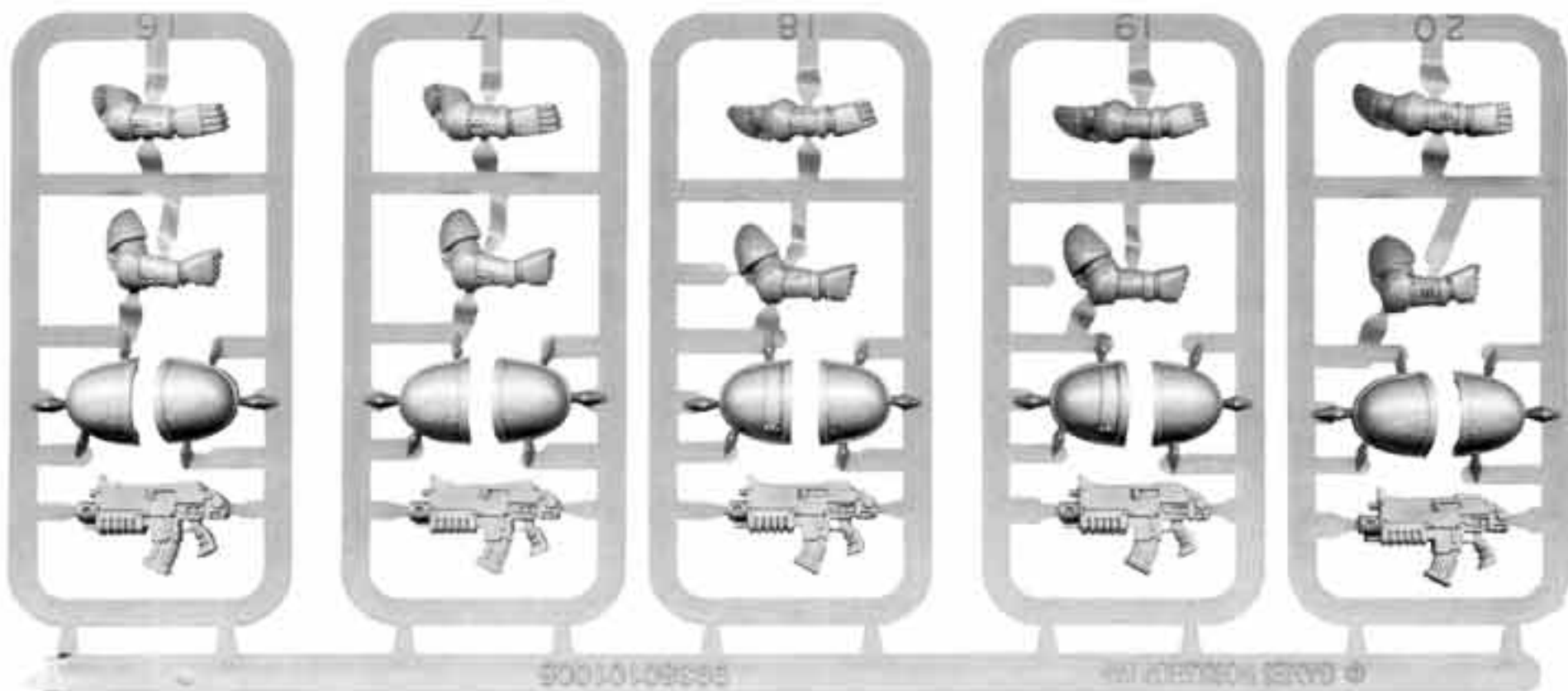

SPACE MARINE ARM & BOLTER SPRUES
(SHOWN AT 90% ACTUAL SIZE)
99380101005



Designed by Jes Goodwin

Not suitable for children under 8 years due to small parts and essential pointed components. All models supplied unpainted.
© Copyright Games Workshop Ltd. 1998. All rights reserved.

SPACE MARINES®

SPACE MARINE DEVASTATORS



HEAVY PLASMA GUN
010118605



PLASMA CANNON ARM
010118606



PLASMA CANNON BACKPACK
010118607

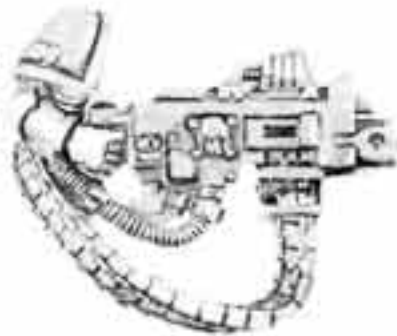

HEAVY BOLTER
010118602



HEAVY BOLTER ARM
010118603



HEAVY BOLTER BACKPACK
010118604



LAS CANNON
010118608



LAS-CANNON
ARM AND SIGHT
010118609



LAS-CANNON BACKPACK
010118610



SERGEANT'S ARM
010118601

A COMPLETE SPACE MARINE
DEVASTATOR CONSISTS OF:
1 x PLASTIC SPACE MARINE
MAIN BODYSPHUE
1 x HEAVY WEAPON
1 x HEAVY WEAPON ARM
1 x HEAVY WEAPON
BACKPACK



SPACE MARINE DEVASTATORS



CITADEL
MINIATURES



CITADEL
MINIATURES

Designed by Jes Goodwin

SPACE MARINES®

PLASTIC ASSAULT MARINES

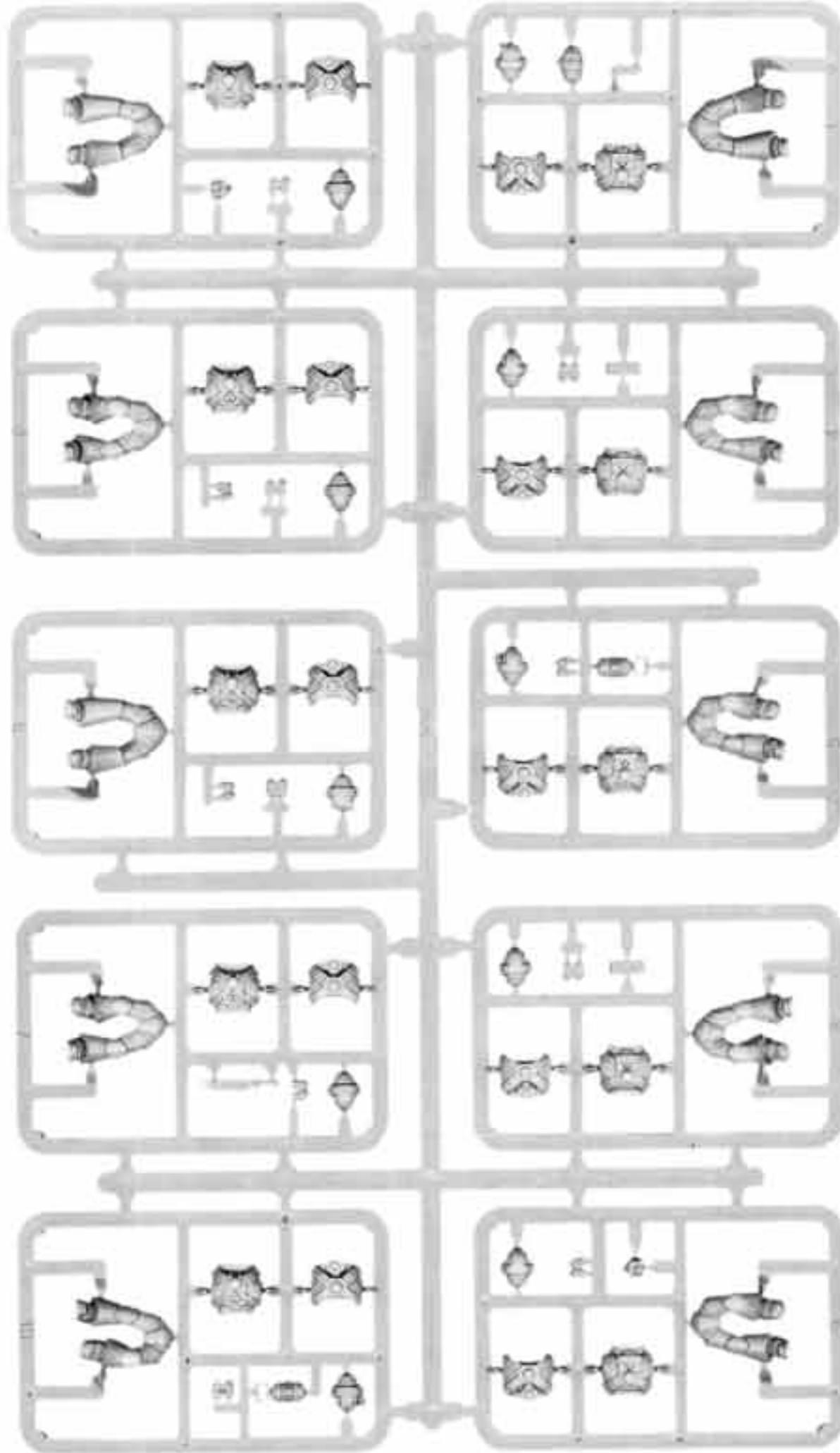

ASSAULT MARINE SPRUE (SHOWN AT 55% OF ACTUAL SIZE)
99380101010



ASSAULT MARINE
JUMP PACK SPRUE
(SHOWN AT ACTUAL SIZE)
99380101011
(COMES AS A SINGLE SPRUE)

- A COMPLETE
PLASTIC ASSAULT MARINE
CONSISTS OF:
- 1 x ASSAULT MARINE SPRUE
 - 1 x LEFT ARM SPACE MARINE
ASSAULT SPRUE
 - 1 x RIGHT ARM SPACE MARINE
ASSAULT SPRUE
 - 1 x ASSAULT MARINE
JUMP PACK SPRUE



ASSAULT MARINE

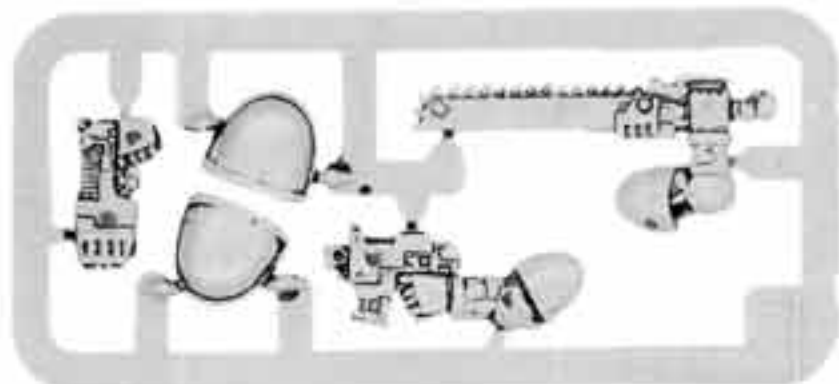

LEFT ARM SPACE MARINE
ASSAULT SPRUE
99380101008

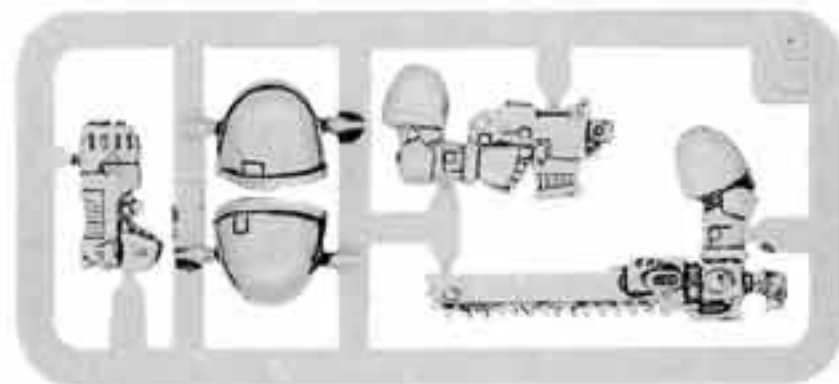

RIGHT ARM SPACE
MARINE ASSAULT SPRUE
99380101009

BOTH SPRUES SHOWN AT ACTUAL SIZE

Designed by Jes Goodwin



SPACE MARINES®

JUMP PACK ASSAULT MARINES



ASSAULT MARINE
JUMP PACK SPRUE
(SHOWN AT ACTUAL SIZE)
99380101011
(COMES AS A SINGLE SPRUE)



SPACE MARINE
ASSAULT MARINE SERGEANT 1
010101003



SPACE MARINE
ASSAULT MARINE SERGEANT 2
010103001



SPACE MARINE
ASSAULT MARINE 2
010101001



SPACE MARINE
ASSAULT MARINE 1
010101002



SPACE MARINE
ASSAULT MARINE 4
010103002



SPACE MARINE
ASSAULT MARINE 3
010103003

A COMPLETE JUMP PACK ASSAULT MARINE CONSISTS

OF:

- 1 x ASSAULT MARINE BODY
- 1 x ASSAULT MARINE JUMP PACK SPRUE
- 1 x SPACE MARINE ASSAULT ARM SPRUE

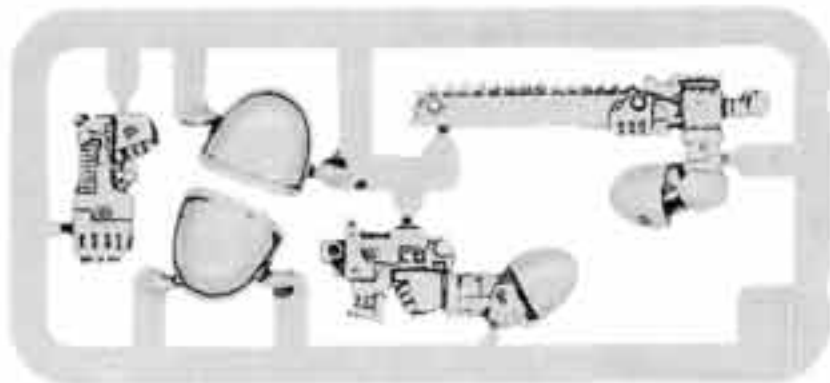

SPACE MARINE ASSAULT
ARM SPRUE 1
99380101008

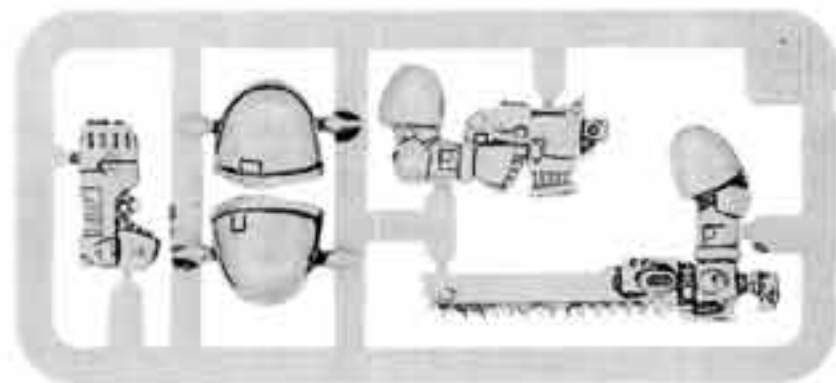

SPACE MARINE ASSAULT
ARM SPRUE 2
99380101009



Designed by Jes Goodwin

SPACE MARINES®

SPACE MARINES



MK6 SPACE MARINE 1
010103348



MK6 SPACE MARINE 2
010103349



MK7 SPACE MARINE 1
010103350



MK7 SPACE MARINE 2
010103351



MK7 SPACE MARINE 3
010101101



MK7 SPACE MARINE 4
010101102



MK7 SPACE MARINE 5
010103355



MK7 SPACE MARINE 6
010103356



MK7 SPACE MARINE 7
010103354

A COMPLETED SPACE MARINE
CONSISTS OF:
1 x SPACE MARINE
1 x SPACE MARINE ARM SPRUE
1 x SPACE MARINE BACKPACK SPRUE



AN EXAMPLE OF A COMPLETED
MK7 SPACE MARINE



AN EXAMPLE OF A COMPLETED
MK6 SPACE MARINE



Designed by Jes Goodwin

Not suitable for children under 36 months due to small parts and essential pointed components. All models supplied unpainted.
© Copyright Games Workshop Ltd., 1997. All rights reserved.

SPACE MARINES[®]

SPACE MARINE SCOUT SERGEANT



SPACE MARINE SCOUT SERGEANT
010108802

SPACE MARINE SCOUT WITH HEAVY BOLTER



SPACE MARINE SCOUT WITH HEAVY BOLTER BODY
010109101



SPACE MARINE SCOUT HEAVY BOLTER
010109102



SPACE MARINE SCOUT HEAVY BOLTER BIPOD
010109103



SPACE MARINE SCOUT WITH HEAVY BOLTER

A COMPLETE SPACE MARINE SCOUT WITH HEAVY BOLTER CONSISTS OF:

- 1 x SPACE MARINE SCOUT WITH HEAVY BOLTER BODY
- 1 x SPACE MARINE SCOUT HEAVY BOLTER
- 1 x SPACE MARINE SCOUT HEAVY BOLTER BIPOD

SPACE MARINE SCOUTS



SPACE MARINE SCOUT 1
010108801



SPACE MARINE SCOUT 2
010108803



SPACE MARINE SCOUT 3
010108804



SPACE MARINE SCOUT 4
010108805



SPACE MARINE SCOUT 5
010109306



SPACE MARINE SCOUT 6
010109307

SPACE MARINE SCOUTS WITH BOLTGUNS



SPACE MARINE SCOUT WITH BOLT GUN
010111301



SPACE MARINE SCOUT WITH BOLT GUN 2
010111302

SPACE MARINE SCOUTS WITH SNIPER RIFLE



SPACE MARINE SCOUT WITH SNIPER RIFLE 1
010109001



SPACE MARINE SCOUT WITH SNIPER RIFLE 2
010109002

SPACE MARINE SCOUTS WITH SHOTGUNS



SPACE MARINE SCOUT WITH SHOTGUN 1
010109003



SPACE MARINE SCOUT WITH SHOTGUN 2
010117804



SPACE MARINES

TERMINATOR CAPTAIN



TERMINATOR CAPTAIN BODY
010111101



STANDARD TOP
010101802



TERMINATOR CAPTAIN
STORM BOLTER
010111103



TERMINATOR CAPTAIN
POWER SWORD
010111102



TERMINATOR CAPTAIN
BANNER POLE
010111104



TERMINATOR CAPTAIN

A COMPLETE TERMINATOR CAPTAIN CONSISTS OF:

- 1 x TERMINATOR CAPTAIN BODY
- 1 x TERMINATOR CAPTAIN
STORM BOLTER
- 1 x TERMINATOR CAPTAIN
POWER SWORD
- 1 x TERMINATOR CAPTAIN BANNER POLE
- 1 x STANDARD TOP

SPACE MARINES

SPACE MARINE COMMAND GROUP



SPACE MARINE COMMANDER
010110301



STORM BOLTER
010110302



APOTHECARY
010110304



APOTHECARY MEDI - PACK
010107203



TECHMARINE
010110305



TECHMARINE
SERVO - ARM
BACKPACK
010107503



POWER AXE
010110306



SPACE MARINE COMPANY
STANDARD BEARER
010110307



COMPANY STANDARD TOP
010101802



VETERAN SERGEANT
010110303

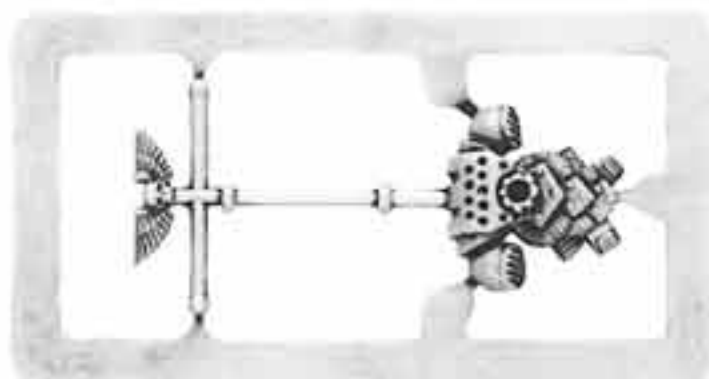

CHARACTER BACKPACK SPRUE
99399999008

A COMPLETE SPACE MARINE
COMMANDER CONSISTS OF:
1 X SPACE MARINE COMMANDER
1 X STORM BOLTER

A COMPLETE APOTHECARY
CONSISTS OF:
1 X APOTHECARY
1 X APOTHECARY MEDI - PACK

A COMPLETE TECHMARINE
CONSISTS OF:
1 X TECHMARINE
1 X POWER AXE
1 X TECHMARINE BACKPACK

A COMPLETE SPACE MARINE
COMPANY STANDARD BEARER
CONSISTS OF:
1 X STANDARD BEARER
1 X COMPANY STANDARD TOP

EACH OF THESE MINIATURES EXCEPT THE APOTHECARY AND TECHMARINE IS SUPPLIED WITH A PLASTIC CHARACTER BACKPACK SPRUE.



SPACE MARINES®

SPACE MARINE CHAPLAINS



SPACE MARINE
CHAPLAIN 1
010103103



SPACE MARINE
CHAPLAIN 2
010103102



SPACE MARINE
CHAPLAIN 3
010103101



SPACE MARINE
CHAPLAIN 4
010103104



BLOOD ANGELS
CHAPLAIN
010100101



CHARACTER ARM SPRUE
99399999007

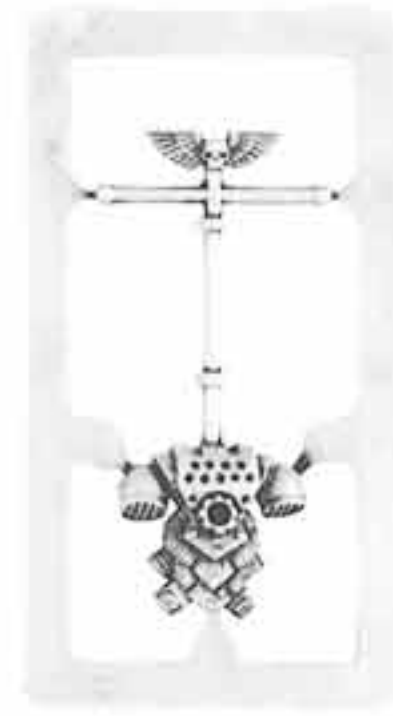

CHARACTER BACKPACK SPRUE
99399999008

THESE MINATURES ARE SUPPLIED WITH A PLASTIC CHARACTER ARM SPRUE AND A PLASTIC CHARACTER BACKPACK SPRUE WHERE APPROPRIATE



SPACE MARINE CHAPLAINS



Designed by Jes Goodwin

Not suitable for children under 8 years due to small parts and essential pointed components. All models supplied unpainted.
© Copyright Games Workshop Ltd. 1998. All rights reserved.

SPACE MARINES®

COMPANY STANDARD BEARER



SPACE MARINE COMPANY STANDARD BEARER
010101801



COMPANY
STANDARD TOP
010101803



BLOOD ANGELS COMPANY
STANDARD TOP
010101802



SPACE MARINE COMPANY STANDARD BEARER

A COMPLETE COMPANY STANDARD
BEARER CONSISTS OF:
1 x COMPANY STANDARD BEARER BODY
1 x COMPANY STANDARD TOP
1 x PLASTIC BACKPACK SPRUE
1 x CHARACTER ARM SPRUE

TECHMARINES

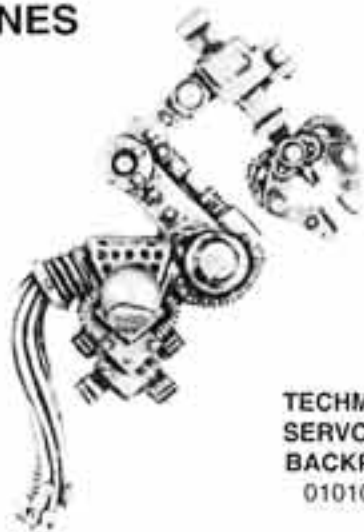

TECHMARINE
SERVO - ARM
BACKPACK 1
010107503



TECHMARINE 2
010107502



TECHMARINE 1
010107501



A COMPLETE TECHMARINE
CONSISTS OF:
1 x TECHMARINE
1 x TECHMARINE BACKPACK
1 x CHARACTER ARM SPRUE



SPACE MARINE TECHMARINE

SPACE MARINES®

SPACE MARINE LIBRARIANS



LEXICANIUM 1
010107001



LEXICANIUM 2
010107002



EPISTOLARY 1
010101901



EPISTOLARY 2
010101902



CODICER 1
010107302



CODICER 2
010107301



CHARACTER ARM SPRUE
99399999007

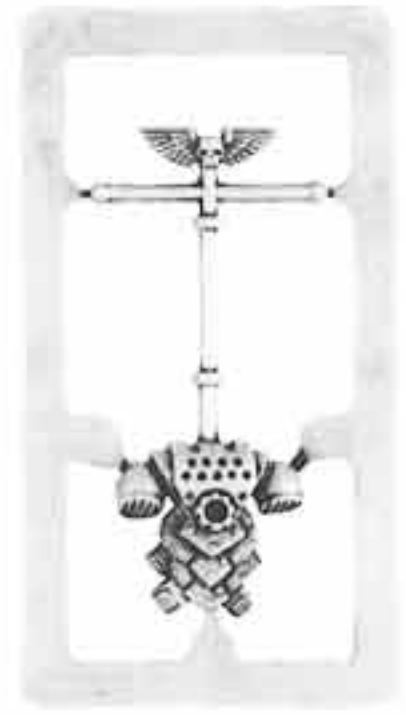

CHARACTER BACKPACK SPRUE
99399999008



EACH OF THESE MINATURES ARE SUPPLIED WITH A PLASTIC CHARACTER ARM SPRUE AND A PLASTIC CHARACTER BACKPACK SPRUE



SPACE MARINE LIBRARIANS



Designed by Jes Goodwin

Not suitable for children under 8 years due to small parts and essential pointed components. All models supplied unpainted.
© Copyright Games Workshop Ltd. 1998. All rights reserved.

SPACE MARINES

MARNEUS CALGAR MASTER OF THE ULTRAMARINES



CALGAR'S RIGHT GAUNTLET
010107402



CALGAR'S BANNER POLE TOP
010107404



MARNEUS CALGAR
010107401



CALGAR'S BANNER POLE
010107403



A COMPLETE MARNEUS CALGAR CONSISTS OF:
1 x MARNEUS CALGAR
1 x CALGAR'S RIGHT GAUNTLET
1 x CALGAR'S BANNER POLE
1 x CALGAR'S BANNER POLE TOP

CHIEF LIBRARIAN TIGURIUS

A COMPLETE TIGURIUS CONSISTS OF:
1 x TIGURIUS
1 x CHARACTER BACKPACK SPRUE



TIGURIUS
010102001

LIBRARIAN IN TERMINATOR ARMOUR

A COMPLETE TERMINATOR LIBRARIAN CONSISTS OF:
1 x LIBRARIAN TERMINATOR BODY
1 x STORM BOLTER
1 x FORCE AXE
1 x LIBRARIAN BANNER POLE



TERMINATOR LIBRARIAN BODY
010104101



LIBRARIAN BANNER POLE
010104103



STORM BOLTER
010100704



FORCE AXE
010104102

CHAPLAIN IN TERMINATOR ARMOUR

A COMPLETE TERMINATOR CHAPLAIN CONSISTS OF:
1 x TERMINATOR CHAPLAIN BODY
1 x STORM BOLTER
1 x CROZIUS ARCANUM
1 x BANNER POLE



TERMINATOR CHAPLAIN BODY
010104001



CHAPLAIN'S BANNER POLE
010104003



STORM BOLTER
010100704



CROZIUS ARCANUM
010104002

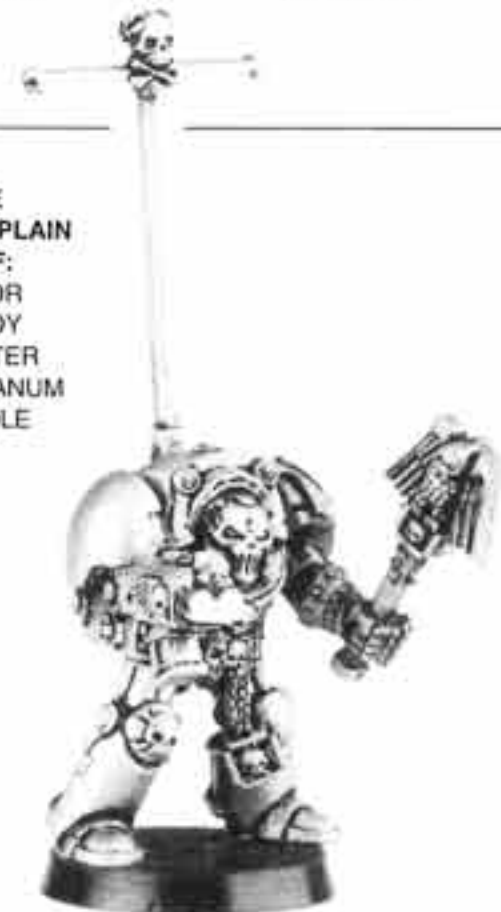

SPACE MARINES[®]

COMMANDER AZRAEL SUPREME GRANDMASTER OF THE DARK ANGELS



COMBI-WEAPON
010102102

THE COMPLETE
COMMANDER AZRAEL
CONSISTS OF:
1 x COMMANDER AZRAEL
1 x LION HELM BEARER
1 x AZRAEL'S BANNER POLE
1 x COMBI-WEAPON
1 x AZRAEL'S BANNER POLE TOP



AZRAEL'S
BANNER POLE TOP
010102104



COMMANDER AZRAEL
010102101



LION HELM BEARER
010102105



AZRAEL'S
BANNER POLE
010102103



DARK ANGEL
SUPREME GRAND MASTER

ASMODAI INTERROGATOR CHAPLAIN

THE COMPLETE
INTERROGATOR CHAPLAIN
CONSISTS OF:
1 x ASMODAI
1 x ASMODAI'S POWER SWORD ARM
1 x CHARACTER BACKPACK SPRUE



ASMODAI
010102201



ASMODAI'S POWER
SWORD ARM
010102202



DARK ANGEL INTERROGATOR CHAPLAIN

EZEKIEL GRAND MASTER OF LIBRARIANS

THE COMPLETE
GRANDMASTER OF LIBRARIANS
CONSISTS OF:
1 x EZEKIEL
1 x EZEKIEL'S FORCE SWORD
1 x CHARACTER BACKPACK SPRUE



EZEKIEL
010102301



EZEKIEL'S FORCE SWORD
010102302



DARK ANGEL
GRAND MASTER OF LIBRARIANS



Designed by Jes Goodwin

Not suitable for children under 36 months due to small parts and essential pointed components. All models supplied unpainted.
© Copyright Games Workshop Ltd., 1997. All rights reserved.

SPACE MARINES®

BROTHER BETHOR BEARER OF THE SACRED STANDARD



BROTHER BETHOR
010102401

A COMPLETE
BEARER OF THE SACRED
STANDARD CONSISTS OF:
1x BROTHER BETHOR
1x DARK ANGELS STANDARD TOP
1x PLASTIC BACKPACK SPRUE
1x CHARACTER ARM SPRUE



DARK ANGELS STANDARD TOP
010102402



BROTHER BETHOR
BEARER OF THE SACRED STANDARD

SPACE MARINE SERGEANTS



BLOOD ANGELS
SERGEANT 1
010107106



SPACE MARINE
SERGEANT 1
010101103



DARK ANGELS
SERGEANT 1
010107105



BLOOD ANGELS
SERGEANT 2
010107107



SPACE MARINE
SERGEANT 2
010100901

THESE MINIATURES ARE SUPPLIED WITH A PLASTIC CHARACTER ARM SPRUE AND A PLASTIC CHARACTER BACKPACK SPRUE



SPACE MARINE SERGEANTS



Designed by Jes Goodwin

SPACE MARINES®

APOTHECARIES

A COMPLETE APOTHECARY CONSISTS OF:
 1 x APOTHECARY
 1 x APOTHECARY'S MEDI-PACK
 1 x CHARACTER ARM SPRUE



APOTHECARY 1
010107201



APOTHECARY 2
010107202



APOTHECARY
MEDI-PACK 1
010107203



SPACE MARINE APOTHECARY

VETERAN SERGEANTS



VETERAN SERGEANT 1
WITH BIONIC EYE
010107102



VETERAN SERGEANT 2
WITH CUSTOMISED
BOLT PISTOL
010107104

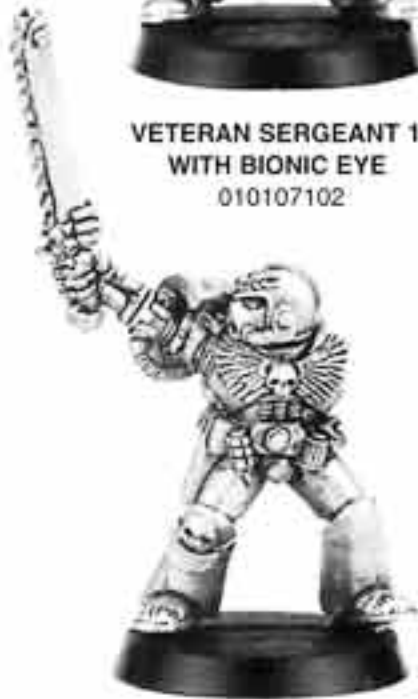

VETERAN SERGEANT 3
WITH BIONIC ARM
010107101



VETERAN SERGEANT 4
WITH AUXILIARY
GRENADE LAUNCHER
010107103

EACH OF THESE MINIATURES IS SUPPLIED WITH A PLASTIC CHARACTER ARM SPRUE
AND A PLASTIC CHARACTER BACKPACK SPRUE



VETERAN SERGEANT
BOLT GUN
010111202

VETERAN SERGEANT
WITH POWER AXE
010111201



A COMPLETE VETERAN
SERGEANT WITH
POWER AXE CONSISTS OF:
 1 x VETERAN SERGEANT
WITH POWER AXE
 1 x VETERAN SERGEANT
BOLTGUN
 1 x CHARACTER BACKPACK
SPRUE



SPACE MARINE VETERAN SERGEANTS



Designed by Jes Goodwin

SPACE MARINES®

COMMANDER DANTE, LORD OF THE BLOOD ANGELS

THE COMPLETE
COMMANDER DANTE
CONSISTS OF:
1 x COMMANDER DANTE'S BODY
1 x COMANDER DANTE'S
JUMP PACK
1 x INFERNO PISTOL



COMMANDER DANTE'S BODY
010102701



COMMANDER DANTE'S
JUMP PACK
010102703



INFERNO PISTOL
010102702



COMMANDER DANTE LORD OF THE
BLOOD ANGELS

BROTHER-CAPTAIN TYCHO

A COMPLETE
BROTHER-CAPTAIN
TYCHO CONSISTS OF:
1 x BROTHER-
CAPTAIN TYCHO
1 x PLASTIC
CHARACTER
BACKPACK SPRUE



BROTHER-CAPTAIN TYCHO
01010281

CHIEF LIBRARIAN MEPHISTON, LORD OF DEATH

A COMPLETE
CHIEF LIBRARIAN MEPHISTON,
LORD OF DEATH CONSISTS OF:
1 x MEPHISTON BODY
1 x FORCE SWORD
1 x PLASTIC CHARACTER BACKPACK SPRUE



MEPHISTON BODY
010102601



FORCE SWORD
010102602



NOTE: THE BANNER
POLE SHOULD BE
REMOVED FROM THE
PLASTIC BACKPACK
FOR THIS PARTICULAR
MINIATURE.



CHIEF LIBRARIAN MEPHISTON, LORD OF DEATH

APOTHECARY CORBULO, SANGUINARY PRIEST OF THE BLOOD ANGELS

A COMPLETE
APOTHECARY CORBULO
CONSISTS OF:
1 x CORBULO BODY
1 x APOTHECARY MEDI-PACK



CORBULO BODY
010102501



APOTHECARY
MEDI-PACK
010107203



APOTHECARY CORBULO



SPACE MARINES

BLOOD ANGELS DEATH COMPANY



DEATH COMPANY
BODY 1
010115901



DEATH COMPANY
BODY 2
010115902



DEATH COMPANY
BODY 3
010115903



DEATH COMPANY
BODY 4
010115904



DEATH COMPANY
BODY 5
010115905



SPACE MARINE POWER
SWORD ARM
010115906



DEATH COMPANY
SHOULDER PAD 1
010115907



DEATH COMPANY
SHOULDER PAD 2
010115908



DEATH COMPANY
SHOULDER PAD 3
010115909



DEATH COMPANY
SHOULDER PAD 4
010115910



DEATH COMPANY
SHOULDER PAD 5
010115911



DEATH COMPANY
SHOULDER PAD 6
010115912



DEATH COMPANY
SHOULDER PAD 7
010115913



DEATH COMPANY
SHOULDER PAD 8
010115914



DEATH COMPANY
SHOULDER PAD 9
010115915



BLOOD ANGELS DEATH COMPANY
SPACE MARINES

A COMPLETE BLOOD ANGELS DEATH COMPANY SPACE MARINE CONSISTS OF:

- 1 x DEATH COMPANY BODY
- 2 x DEATH COMPANY SHOULDER PADS
(IN ANY COMBINATION)
- 1 x SPACE MARINE ASSAULT ARM SPRUE
- 1 x SPACE MARINE BACKPACK

PLEASE NOTE THAT THE SPACE MARINE POWER SWORD
ARM AND DEATH COMPANY SHOULDER PADS ARE
OPTIONAL EXTRAS AND MAY BE ATTACHED TO ANY OF
YOUR BLOOD ANGELS DEATH COMPANY
SPACE MARINES



Designed by Mike McVey

SPACE MARINES

ASSAULT MARINE SPRUE



SPACE MARINE ASSAULT
ARM SPRUE 1
99380101008

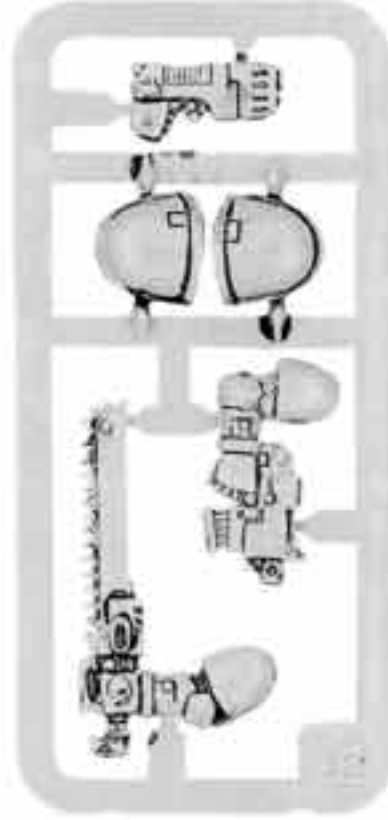

SPACE MARINE ASSAULT
ARM SPRUE 2
99380101009



EXAMPLE OF A COMPLETE BLOOD ANGELS
DEATH COMPANY SPACE MARINES USING THE
SPACE MARINE ASSAULT SPRUE

BLOOD ANGELS CHAPLAIN LEMARTES

A COMPLETE BLOOD ANGELS CHAPLAIN
LEMARTES CONSISTS OF:

- 1 x BLOOD ANGELS
CHAPLAIN LEMARTES
- 1 x LEMARTES BOLT PISTOL
- 1 x ASSAULT MARINE JUMP PACK SPRUE



BLOOD ANGELS
CHAPLAIN LEMARTES
010116501



LEMARTES BOLT PISTOL
010116502



ASSAULT MARINE
JUMP PACK SPRUE
(SHOWN AT ACTUAL SIZE)
99380101011
(COMES AS A SINGLE SPRUE)



BLOOD ANGELS CHAPLAIN LEMARTES



CITADEL
MINIATURES



CITADEL
MINIATURES

SPACE MARINES®

SPACE MARINE CAPTAINS



SPACE MARINE CAPTAIN WITH
TERMINATOR HONOURS
010104601



SPACE MARINE DARK
ANGELS CAPTAIN
010105005



SPACE MARINE
ULTRAMARINES CAPTAIN
010104819

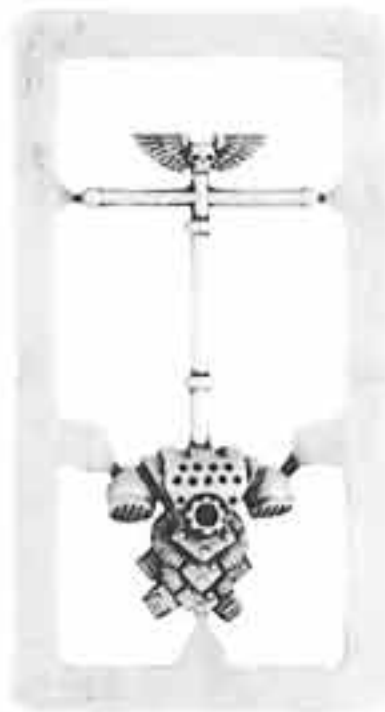

CHARACTER BACKPACK
SPRUE
99399999005

A COMPLETE
SPACE MARINE CAPTAIN
CONSISTS OF:
1 x SPACE MARINE CAPTAIN
1 x SPACE MARINE
CHARACTERS BACKPACK SPRUE



SPACE MARINE VETERAN
CAPTAIN
010104702

BLOOD ANGELS SPACE MARINES



BLOOD ANGELS
SPACE MARINE 1
010100103



BLOOD ANGELS
SPACE MARINE 2
010100104



BLOOD ANGELS
SPACE MARINE 3
010100102

THESE MINIATURES ARE SUPPLIED WITH PLASTIC SPACE MARINE ARMS AND BACKPACK SPRUES



Designed by Jes Goodwin

SPACE MARINES®

WOLF LORD RAGNAR BLACKMANE



RAGNAR BLACKMANE'S BODY
010106301



RAGNAR BLACKMANE'S
BACKPACK
010106302



WOLF LORD RAGNAR
BLACKMANE

WOLF PRIEST ULRIK THE SLAYER



ULRIK THE SLAYER'S BODY
010106401



SPACE WOLVES BACK BANNER 2
010106602



NJAL STORMCALLER'S BODY
010106601

SPACE WOLVES GREY HUNTERS



GREY HUNTER 1
MK7 SPACE MARINE
010101302



GREY HUNTER 2
MK7 SPACE MARINE
010101303



GREY HUNTER 3
MK7 SPACE MARINE
010101304

A COMPLETE SPACE WOLVES
GREY HUNTER CONSISTS OF:
1 x GREY HUNTER
1 x SPACE MARINE ARM
SPRUE
1 x SPACE MARINE BACK
PACK SPRUE



SPACE MARINES®

IRON PRIEST



IRON PRIEST
010106701



IRON PRIEST BACKPACK
010106702



SPACE WOLF IRON PRIEST

THE COMPLETE IRON PRIEST
CONSISTS OF:
1 x IRON PRIEST
1 x IRON PRIEST BACKPACK

WOLF GUARD IN POWER ARMOUR



WOLF GUARD 1
010106501



WOLF GUARD 3
010106503



WOLF GUARD 2
COMPANY STANDARD
010106502



WOLF GUARD 4
010106504



WOLF GUARD

A COMPLETE WOLF GUARD IN POWER ARMOUR
CONSISTS OF:
1 x WOLF GUARD
1 x CHARACTER ARM SPRUE
1 x CHARACTER BACKPACK



CITADEL
MINIATURES



CITADEL
MINIATURES

Designed by Jes Goodwin

Not suitable for children under 8 years due to small parts and essential pointed components. All models supplied unpainted.
© Copyright Games Workshop Ltd. 1998. All rights reserved.

SPACE MARINES®

SPACE WOLVES SERGEANTS



SPACE WOLVES
LONG FANG SERGEANT
010101501



SPACE WOLVES
BLOOD CLAW SERGEANT
010101601



GREY HUNTER
SPACE MARINE SERGEANT
010101301

A COMPLETED SPACE WOLVES
SERGEANT CONSISTS OF :
1 x SPACE WOLVES SERGEANT
1 x CHARACTER BACKPACK SPRUE
1 x CHARACTER ARM SPRUE

SPACE WOLVES BLOOD CLAWS



SPACE WOLVES
BLOOD CLAW 1
010101602



SPACE WOLVES
BLOOD CLAW 2
010101603



SPACE WOLVES
BLOOD CLAW 3
010101604

A COMPLETED SPACE WOLVES
BLOOD CLAW CONSISTS OF:
1 x SPACE WOLVES BLOOD CLAW
1 x SPACE MARINE BACKPACK SPRUE
1 x SPACE MARINE ARMS SPRUE
1 x SPACE MARINE
CLOSE ASSAULT SPRUE

Designed by Jes Goodwin



SPACE MARINES®

SPACE WOLF DREADNOUGHT

THE COMPLETE SPACE WOLF DREADNOUGHT
CONSISTS OF:

- 1 x SPACE WOLVES DREADNOUGHT SARCOPHAGUS
- 1 x SPACE MARINE DREADNOUGHT REAR BODY
- 1 x SPACE MARINE DREADNOUGHT LOWER BODY
- 1 x SPACE MARINE DREADNOUGHT LEGS
- 2 x SPACE MARINE DREADNOUGHT FEET
- 1 x SPACE MARINE DREADNOUGHT POWER PLANT
- 1 x SPACE MARINE DREADNOUGHT ASSAULT CANNON
- 1 x SPACE WOLVES DREADNOUGHT LIGHTNING CLAW ARM
- 1 x SPACE WOLVES DREADNOUGHT LIGHTNING CLAW
- 1 x SPACE MARINE DREADNOUGHT AUTO - LAUNCHER
- 1 x SPACE WOLVES DREADNOUGHT BANNER POLE

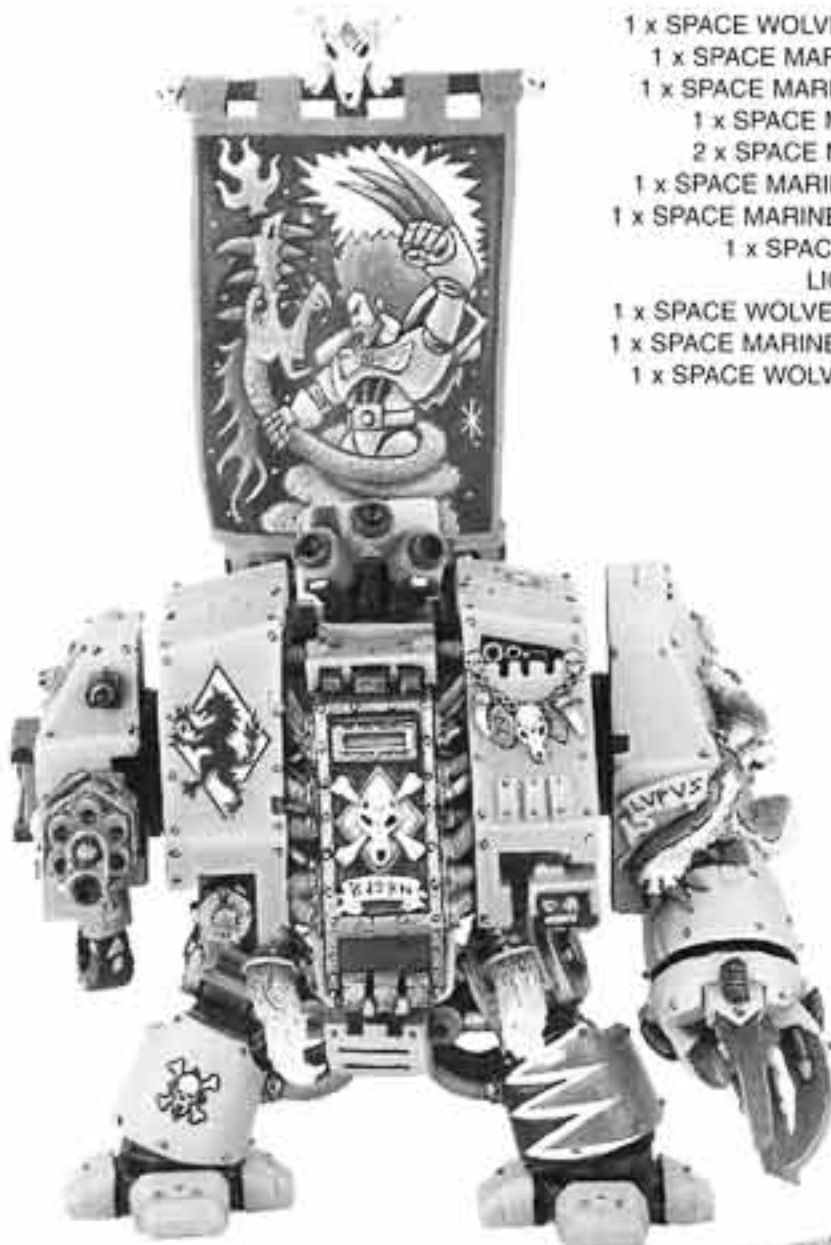

SPACE WOLF DREADNOUGHT



SPACE MARINE DREADNOUGHT
REAR BODY
010100211



SPACE MARINE DREADNOUGHT
LOWER BODY
010100202



SPACE WOLVES DREADNOUGHT
BANNER POLE
010100415



SPACE MARINE DREADNOUGHT
HANDLED LEGS
010100209



SPACE MARINE DREADNOUGHT
AUTO - LAUNCHER
010100207

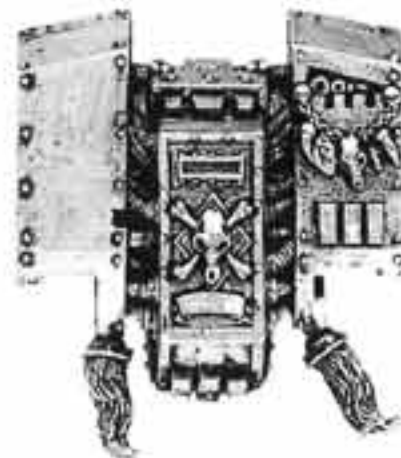

SPACE WOLVES DREADNOUGHT SARCOPHAGUS
010100410



SPACE WOLVES DREADNOUGHT
LIGHTNING CLAW
010100414



SPACE MARINE DREADNOUGHT FOOT
010100208

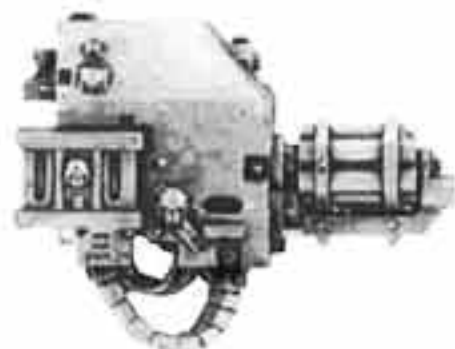

SPACE MARINE DREADNOUGHT ASSAULT CANNON
010100416

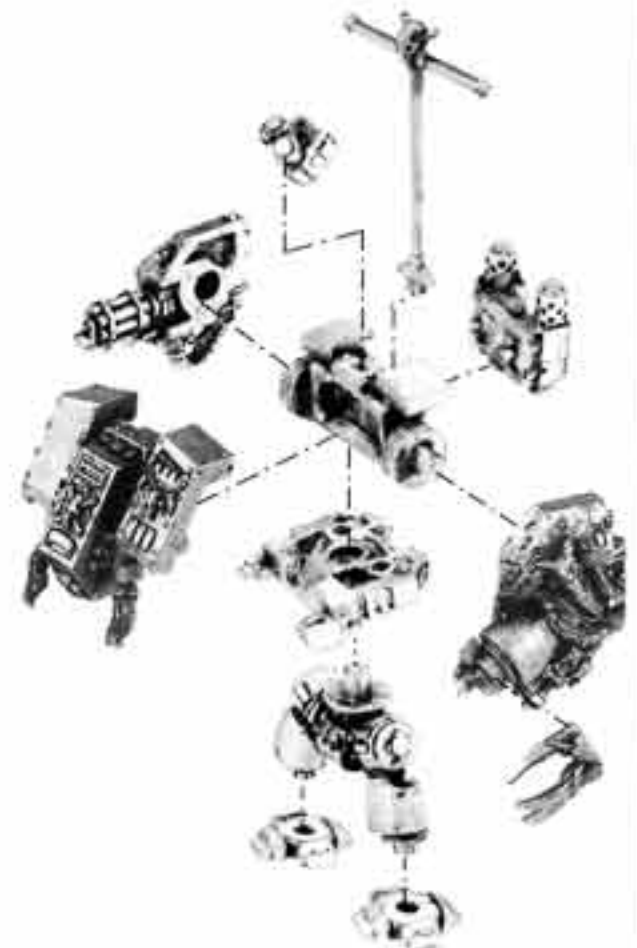

SPACE MARINE DREADNOUGHT POWER PLANT
010100204



SPACE WOLVES DREADNOUGHT
LIGHTNING CLAW ARM
010100413



Designed by Jes Goodwin

Not suitable for children under 8 years due to small parts and essential pointed components. All models supplied unpainted.
© Copyright Games Workshop Ltd. 1998. All rights reserved.

SPACE MARINES®

LEGION OF THE DAMNED TROOPERS



LEGION OF THE DAMNED
TROOPER 1
010109605



LEGION OF THE DAMNED
TROOPER 2
010109606



LEGION OF THE DAMNED
TROOPER 3
010109607



LEGION OF THE DAMNED
TROOPER 4
010109608

LEGION OF THE DAMNED TROOPERS ARE SUPPLIED WITH A SEPARATE PLASTIC MARINE ARM SPRUE, LEGION OF THE DAMNED WEAPON, SHOULDER PADS AND BACKPACKS



LEGION OF THE DAMNED
TROOPER 5
010109609



LEGION OF THE DAMNED
TROOPER 6
010109610



LEGION OF THE DAMNED
TROOPER 7
010109611



LEGION OF THE DAMNED
TROOPER 8
010109728



LEGION OF THE DAMNED
TROOPER 9
010109729



LEGION OF THE DAMNED
TROOPER 10
010109730



LEGION OF THE DAMNED
TROOPER 11
010109731



LEGION OF THE DAMNED
TROOPER 12
010109732



LEGION OF THE DAMNED
TROOPER 13
010109733



LEGION OF THE DAMNED
TROOPER 14
010109734



LEGION OF THE DAMNED
SHOULDER PAD 1
010109624



LEGION OF THE DAMNED
SHOULDER PAD 2
010109627



LEGION OF THE DAMNED
SHOULDER PAD 3
010109623



LEGION OF THE DAMNED
SHOULDER PAD 4
010109620



LEGION OF THE DAMNED
SHOULDER PAD 5
010109619



LEGION OF THE DAMNED
SHOULDER PAD 6
010109618



LEGION OF THE DAMNED
SHOULDER PAD 7
010109622



LEGION OF THE DAMNED
SHOULDER PAD 8
010109625



LEGION OF THE DAMNED
SHOULDER PAD 9
010109621



LEGION OF THE DAMNED
SHOULDER PAD 10
010109617



LEGION OF THE DAMNED
GUN SPRUE A
010109612



LEGION OF THE DAMNED
GUN SPRUE B
010109613



LEGION OF THE DAMNED
BACKPACK 1
010109614



LEGION OF THE DAMNED
BACKPACK 2
010109615



LEGION OF THE DAMNED
BACKPACK 3
010109616



LEGION OF THE DAMNED
SHOULDER PAD 11
010109626



Designed by Jes Goodwin, Dave Perry, Mark Bedford and Mike McVey

SPACE MARINES

LEGION OF THE DAMNED ASSAULT WEAPONS

THESE MINIATURES REQUIRE A
LEGION OF THE DAMNED BACKPACK



LEGION OF THE DAMNED
FLAMER
010109604



LEGION OF THE DAMNED
PLASMA GUN
010109906



LEGION OF THE DAMNED
MELTAGUN
010109905

LEGION OF THE DAMNED SERGEANTS

THESE MINIATURES ARE SUPPLIED WITH A SEPARATE
SPACE MARINE ARM SPRUE



LEGION OF THE DAMNED
SERGEANT 1
010109601



LEGION OF THE DAMNED
SERGEANT 2
010109802



COMPLETED SERGEANT 1



COMPLETED SERGEANT 2

A COMPLETE
LEGION OF THE DAMNED SERGEANT
CONSISTS OF:
1 x SERGEANT'S BODY
1 x LEGION OF THE DAMNED BACKPACK
1 x LEGION OF THE DAMNED SHOULDER PAD
1 x PLASTIC ARM (SUPPLIED ON SPRUE)

LEGION OF THE DAMNED HEAVY WEAPONS



HEAVY WEAPONS
LEGIONNAIRE BODY 1
010109602



HEAVY WEAPONS
LEGIONNAIRE BODY 2
0101010004



HEAVY WEAPONS
LEGIONNAIRE BODY 3
0101010006



LEGION OF THE DAMNED HEAVY WEAPON TROOPER

A COMPLETE
LEGION OF THE DAMNED HEAVY WEAPONS
TROOPER CONSISTS OF:
1 x LEGIONNAIRE'S BODY
1 x LEGION OF THE DAMNED HEAVY WEAPON
1 x LEGION OF THE DAMNED BACKPACK
2 x LEGION OF THE DAMNED SHOULDER PADS
2 x PLASTIC ARMS (SUPPLIED ON SPRUE)



LEGION OF THE DAMNED
HEAVY BOLTER
010109603



LEGION OF THE DAMNED
MISSILE LAUNCHER
0101010007



LEGION OF THE DAMNED
LASCANNON
0101010005



Designed by Jes Goodwin, Dave Perry, Mark Bedford and Mike McVey.

Not suitable for children under 8 years due to small parts and essential pointed components. All models supplied unpainted.
© Copyright Games Workshop Ltd. 1998. All rights reserved.

SPACE MARINES

IMPERIAL FISTS



IMPERIAL FISTS
SHOULDER PAD 1
010110801



IMPERIAL FISTS
SHOULDER PAD 2
010110802



IMPERIAL FISTS
SHOULDER PAD 3
010110803



IMPERIAL FISTS
STORM BOLTER 1
010110701



IMPERIAL FISTS
SHOULDER PAD 4
010110804



IMPERIAL FISTS
SHOULDER PAD 5
010110805



IMPERIAL FISTS
EPISTOLARY
SHOULDER PAD
010110507



IMPERIAL FISTS
STORM BOLTER 2
010110702



IMPERIAL FISTS CHAPLAIN
SHOULDER PAD
010110608



IMPERIAL FISTS
CAPTAIN
010110401



IMPERIAL FISTS
HEAVY FLAMER
010110703



IMPERIAL FISTS
BANNER POLE
010110704

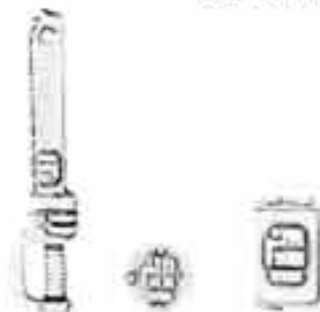

IMPERIAL FISTS
EQUIPMENT SPRUE
010110806



IMPERIAL FISTS
STORM SHIELD
010110705



Designed by the Citadel Design Team

Not recommended for children under 8 years due to small parts and essential pointed components. All models supplied unpainted.
© Copyright Games Workshop Ltd. 1998. All rights reserved.

SPACE MARINES®

SPACE MARINE TERMINATORS

THESE TERMINATOR MODELS MAY BE USED FOR ANY SPACE MARINE CHAPTER.

THE BOX SET CONSISTS OF:
 3 x TERMINATOR TROOPERS
 1 x TERMINATOR WITH HEAVY FLAMER
 1 x TERMINATOR SERGEANT
 3 x BANNER SHEETS
 2 x TRANSFER SHEETS

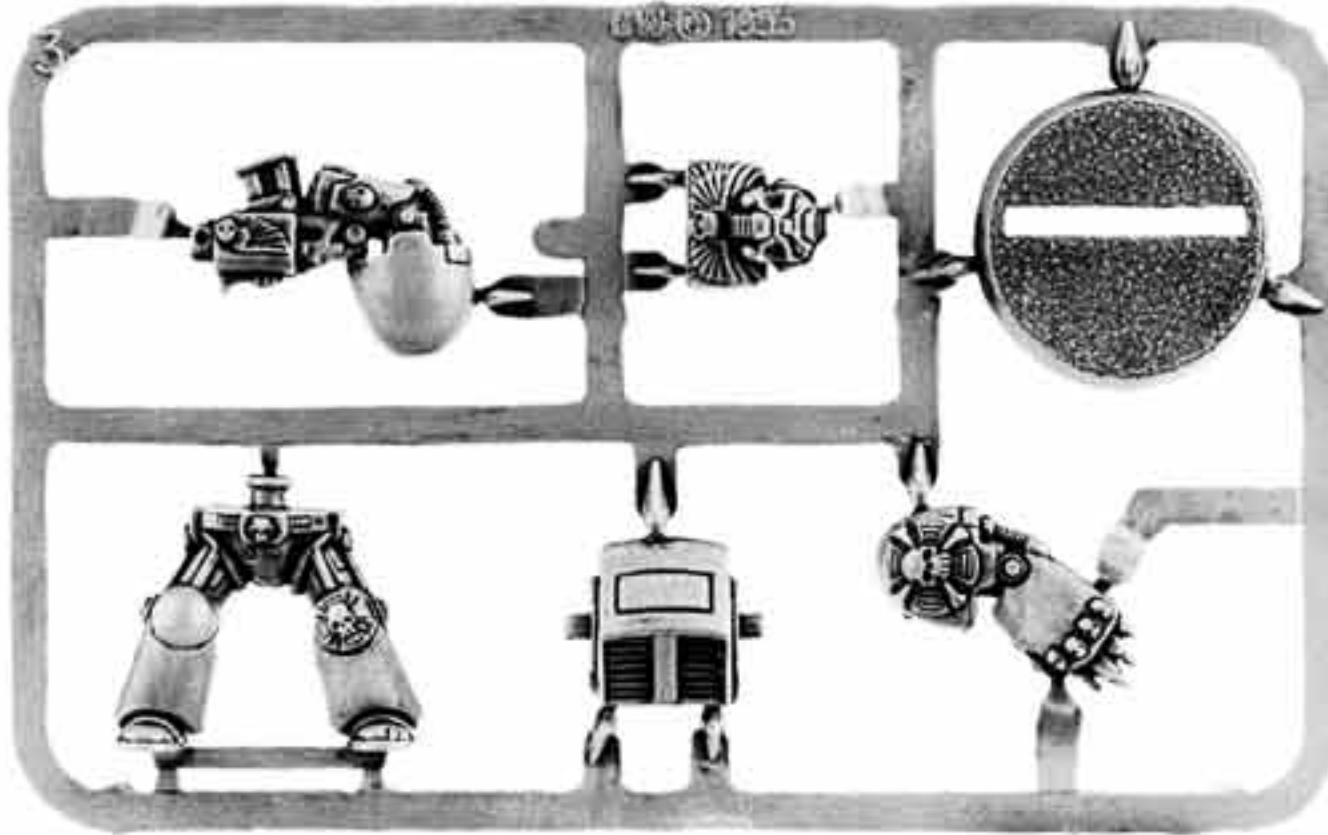

TERMINATOR TROOPER SPRUE 99389999025



TERMINATOR WITH STORM BOLTER

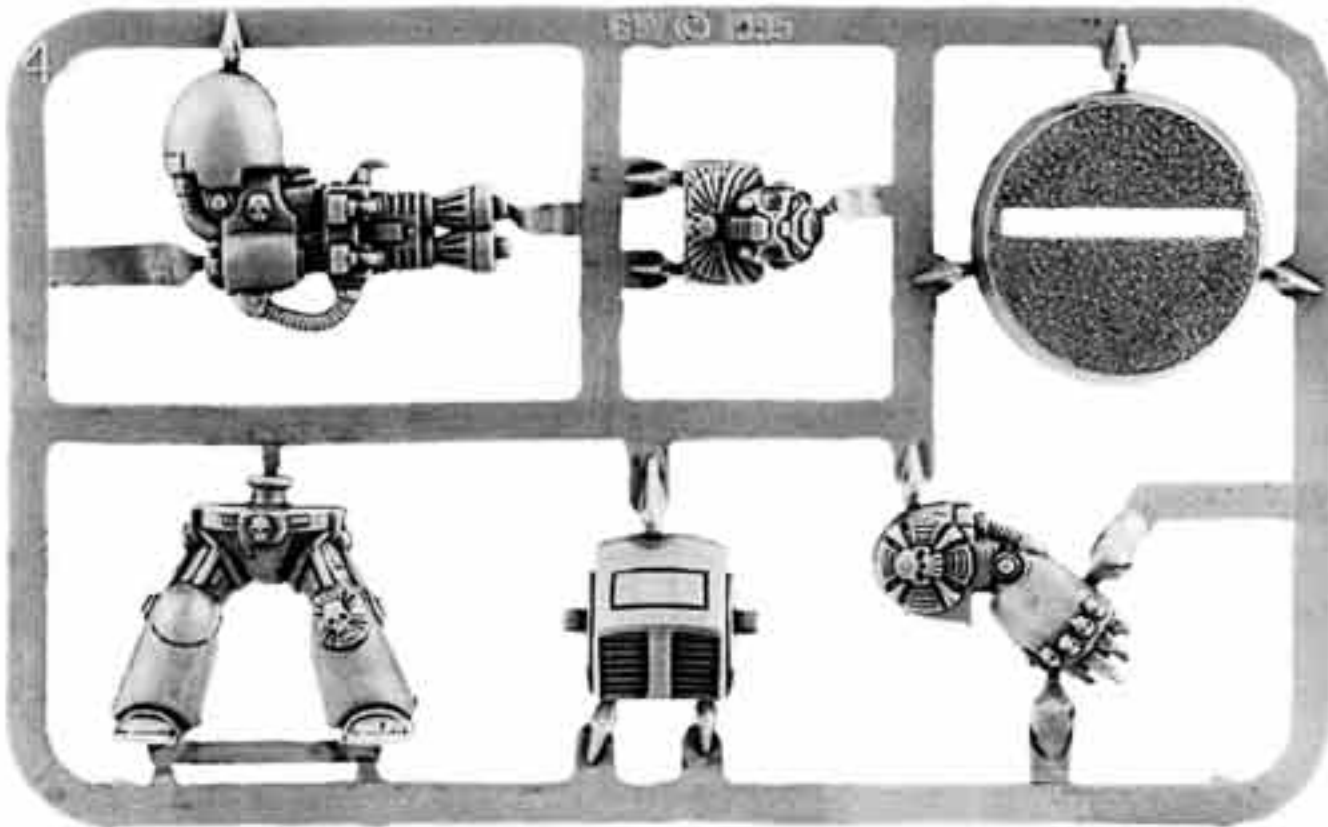

TERMINATOR HEAVY FLAMER SPRUE 99389999025



TERMINATOR WITH HEAVY FLAMER

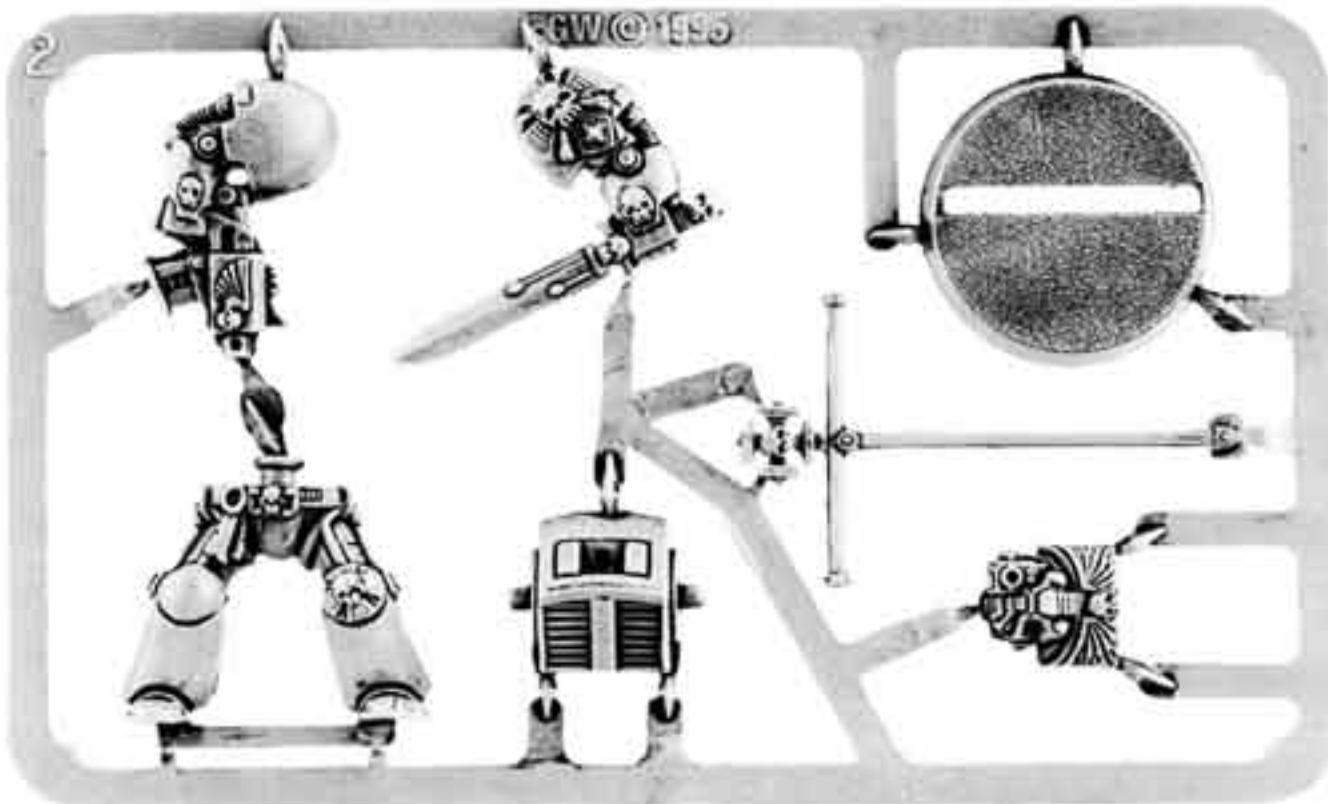

TERMINATOR SERGEANT SPRUE 99389999024



TERMINATOR SERGEANT



Designed by Jes Goodwin

SPACE MARINES®

TERMINATORS



TERMINATOR BODY 1
010104201



TERMINATOR BODY 2
010100703



TERMINATOR BODY 3
010104202



TERMINATOR SERGEANT BODY
010100701

RIGHT HAND WEAPONS

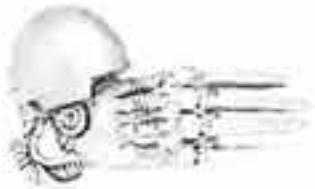

RIGHT LIGHTNING CLAW
010103911



STORM BOLTER
010100704



HEAVY FLAMER
010103810

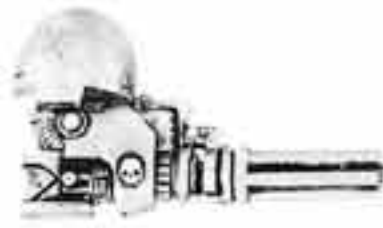

ASSAULT CANNON
010100705

LEFT HAND WEAPONS



LEFT LIGHTNING CLAW
010103912



POWER FIST
010100706



CHAINFIST
010100708



POWER SWORD
010100707



SERGEANT STANDARD POLE
010100702



TERMINATOR SHIELD
010101709

CYCLONE MISSILE LAUNCHER



CYCLONE MISSILE LAUNCHER FRONT
010104205



CYCLONE MISSILE LAUNCHER BODY
010104204



TARGETER
010104203

THUNDER HAMMER AND STORM SHIELD



STORM SHIELD ARM
010104304



STORM SHIELD
010104305



THUNDER HAMMER
010104303

A COMPLETE SPACE MARINE TERMINATOR CONSISTS OF:

- 1 x TERMINATOR BODY
- 1 x LEFT ARM
- 1 x RIGHT ARM

A COMPLETE SPACE MARINE TERMINATOR SERGEANT CONSISTS OF:

- 1 x TERMINATOR SERGEANT BODY
- 1 x STORM BOLTER ARM
- 1 x POWER SWORD ARM
- 1 x TERMINATOR SHIELD
- 1 x SERGEANT STANDARD POLE

A COMPLETE CYCLONE TERMINATOR CONSISTS OF:

- 1 x TERMINATOR BODY
- 1 x CYCLONE BODY
- 1 x CYCLONE FRONT
- 1 x STORM BOLTER
- 1 x TARGETER

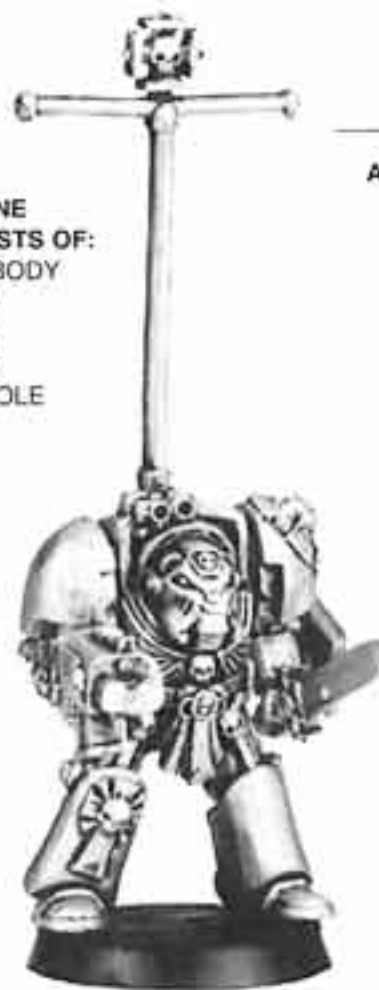

SPACE MARINE TERMINATORS

SPACE MARINES®

DEATHWING TERMINATORS



DEATHWING
TERMINATOR 1
010101701



DEATHWING
TERMINATOR 2
010101702



DEATHWING
SERGEANT
010101707

RIGHT HAND WEAPONS

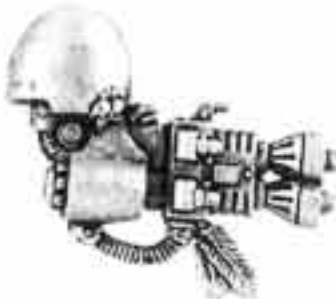

DEATHWING
HEAVY FLAMER
010101704



DEATHWING
STORM BOLTER
010101703



DEATHWING
ASSAULT CANNON
010106911



TERMINATOR
SHIELD
010101709

LEFT HAND WEAPONS



DEATHWING
CHAINFIST
010101705



DEATHWING
POWER GLOVE
010101705



DEATHWING
POWER SWORD
010101708



DEATHWING
BACK BANNER
010101710



A COMPLETE DEATHWING TERMINATOR CONSISTS OF:

- 1 X DEATHWING BODY
- 1 X DEATHWING LEFT ARM
- 1 X DEATHWING RIGHT ARM

THE DEATHWING TERMINATOR SERGEANT CONSISTS OF:

- 1 X DEATHWING SERGEANT
- 1 X DEATHWING POWER SWORD
- 1 X DEATHWING STORM BOLTER
- 1 X DEATHWING BACK BANNER



DEATHWING TERMINATORS

Designed by Jes Goodwin

Not suitable for children under 8 years due to small parts and essential pointed components. All models supplied unpainted
© Copyright Games Workshop Ltd. 1998. All rights reserved.

SPACE MARINES®

WOLF GUARD TERMINATORS



**WOLF GUARD
TERMINATOR SERGEANT**
010101401

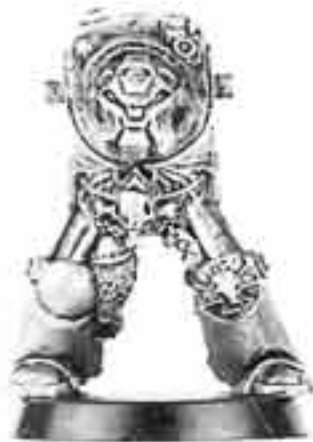

**WOLF GUARD
TERMINATOR 1**
010101402



**WOLF GUARD
TERMINATOR 2**
010101403



**WOLF GUARD
RUNEPRIEST**
010106810



**WOLF GUARD
FORCE AXE**
010106811



**WOLF GUARD
HEAVY FLAMER**
010101406

**EACH COMPLETE WOLF GUARD
TERMINATOR CONSISTS OF:**
1 x WOLF GUARD TERMINATOR RIGHT ARM
1 x WOLF GUARD TERMINATOR LEFT ARM
1 x WOLF GUARD TERMINATOR BODY



**WOLF GUARD
POWER SWORD**
010101409

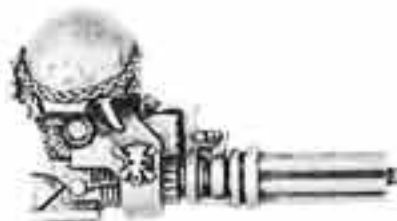

**WOLF GUARD
ASSAULT CANNON**
010101404



**WOLF GUARD
POWER FIST**
010101407



**WOLF GUARD
STORM BOLTER**
010101405



**WOLF GUARD
CHAIN FIST**
010101408



WOLF GUARD TERMINATORS



SPACE MARINES

SPACE MARINE DREADNOUGHT

THE COMPLETE SPACE MARINE DREADNOUGHT CONTAINS:

- 1 x SPACE MARINE DREADNOUGHT SARCOPHAGUS
- 1 x SPACE MARINE DREADNOUGHT REAR BODY
- 1 x SPACE MARINE DREADNOUGHT LOWER BODY
- 1 x SPACE MARINE DREADNOUGHT LEGS
- 2 x SPACE MARINE DREADNOUGHT FEET
- 1 x SPACE MARINE DREADNOUGHT POWER PLANT
- 1 x SPACE MARINE DREADNOUGHT RIGHT HAND WEAPON
- 1 x SPACE MARINE DREADNOUGHT LEFT ARM WEAPON COMPLETE
- 1 x SPACE MARINE DREADNOUGHT AUTO - LAUNCHER
- 1 x SPACE MARINE DREADNOUGHT BANNER POLE



ULTRAMARINES DREADNOUGHT

LEFT ARM WEAPONS



SPACE MARINE DREADNOUGHT MISSILE LAUNCHER POD
010100521



SPACE MARINE DREADNOUGHT MISSILE LAUNCHER
010100520



SPACE MARINE DREADNOUGHT POWER FIST
010100206

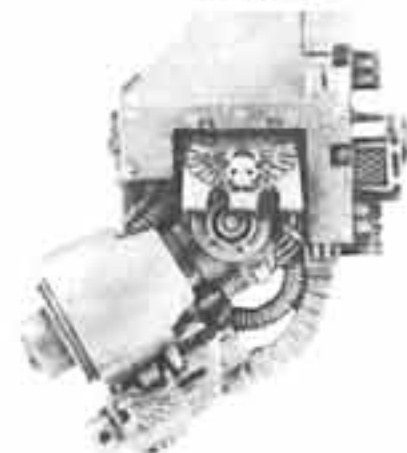

SPACE MARINE DREADNOUGHT POWER FIST ARM
010100205

RIGHT ARM WEAPONS

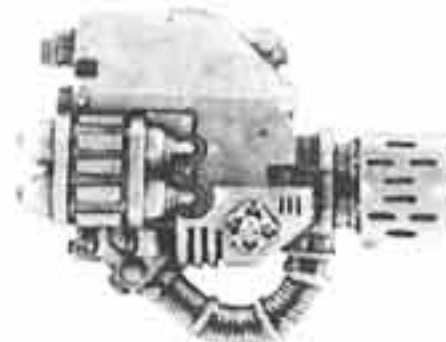

SPACE MARINE DREADNOUGHT MULTI - MELTA
010100203

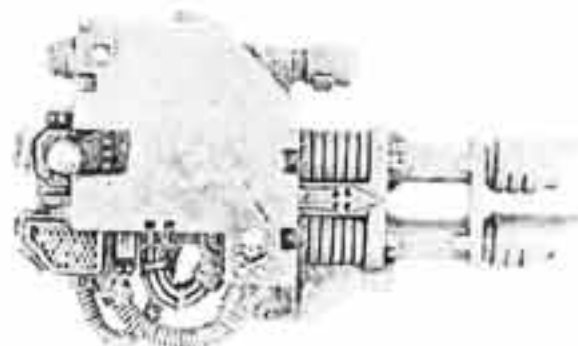

SPACE MARINE DREADNOUGHT TWIN LASCANNON
010100519

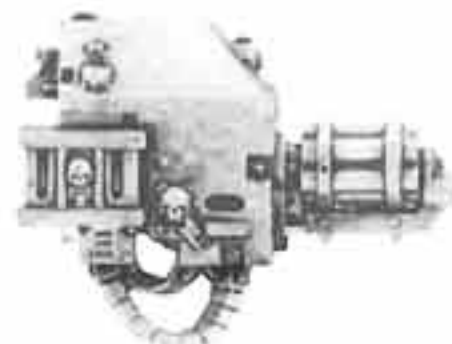

SPACE MARINE DREADNOUGHT ASSAULT CANNON
010100416



SPACE MARINE DREADNOUGHT REAR BODY
010100211



SPACE MARINE DREADNOUGHT AUTO - LAUNCHER
010100207

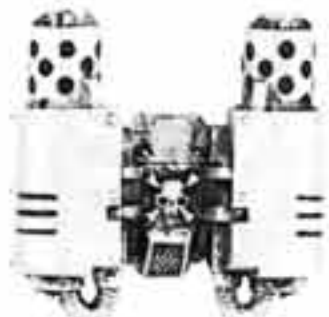

SPACE MARINE DREADNOUGHT POWER PLANT
010100204

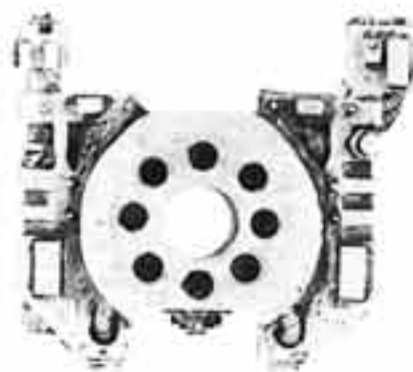

SPACE MARINE DREADNOUGHT LOWER BODY
010100202



SPACE MARINE DREADNOUGHT FOOT
010100208



SPACE MARINE DREADNOUGHT LEGS
010100209



Designed by Jes Goodwin

Not suitable for children under 8 years due to small parts and essential pointed components. All models supplied unpainted.
© Copyright Games Workshop Ltd. 1998. All rights reserved.

SPACE MARINES

SPACE MARINE DREADNOUGHT

THIS IS A CODEX DREADNOUGHT WHICH MAY BE USED BY ANY SPACE MARINE CHAPTER. A CODEX DREADNOUGHT MAY BE ARMED WITH ANY COMBINATION OF WEAPONS PICTURED IN THIS ASSEMBLY DIAGRAM.

WHEN ORDERING YOUR DREADNOUGHT THROUGH MAIL ORDER PLEASE STATE WHICH WEAPONS, SARCOPHAGUS AND BANNER POLES YOU REQUIRE.

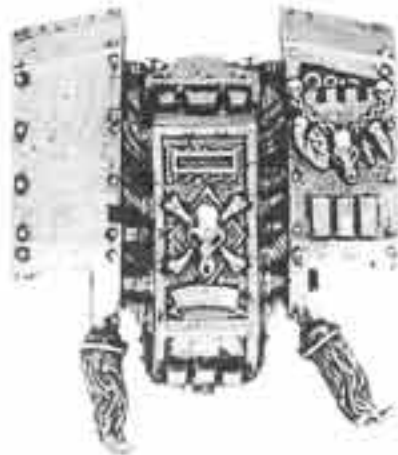
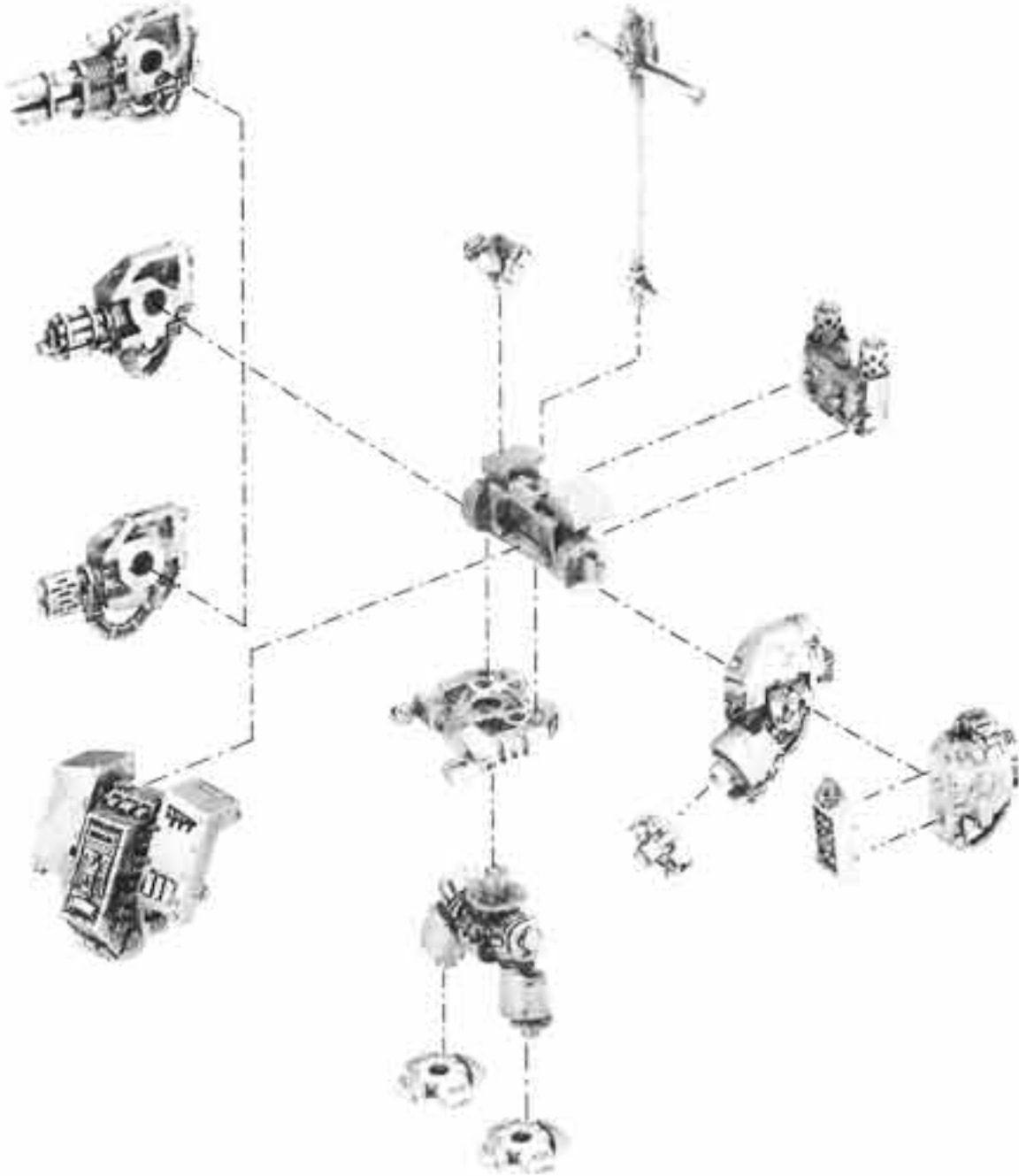

SPACE WOLVES DREADNOUGHT
SARCOPHAGUS
010100410



DARK ANGELS DREADNOUGHT
SARCOPHAGUS
010100526

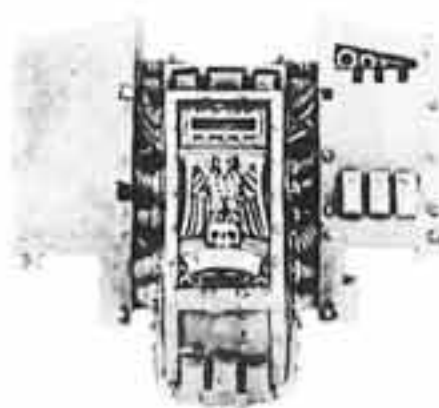

CODEX DREADNOUGHT
SARCOPHAGUS
010100820

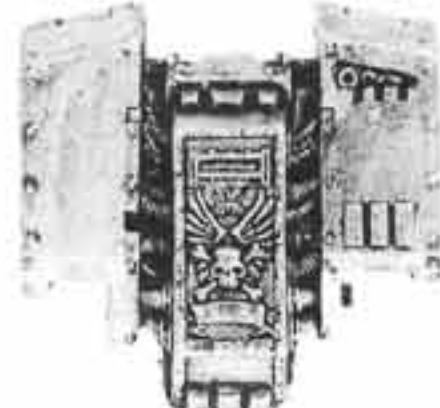

BLOOD ANGELS DREADNOUGHT
SARCOPHAGUS
010100201



DARK ANGELS DREADNOUGHT
BANNER POLE
010100525



CODEX DREADNOUGHT
BANNER POLE
010100821



BLOOD ANGELS DREADNOUGHT
BANNER POLE
010100212



SPACE WOLVES DREADNOUGHT
BANNER POLE
010100415



Designed by Jes Goodwin

SPACE MARINES®

SPACE MARINE BIKE

A COMPLETED SPACE MARINE BIKE
CONSISTS OF:
2 x SMALL WHEEL SPRUES
1 x SPACE MARINE BIKE SPRUE
1 x SPACE MARINE BACKPACK SPRUE



SPACE MARINE BIKE

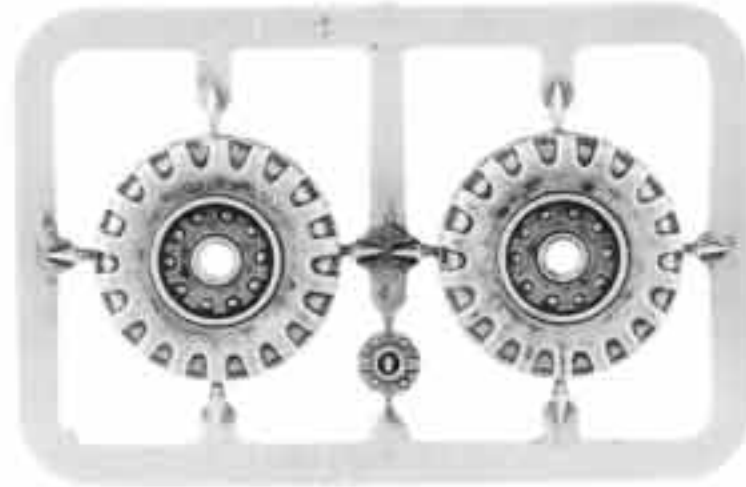

SMALL WHEEL SPRUE
9939999034

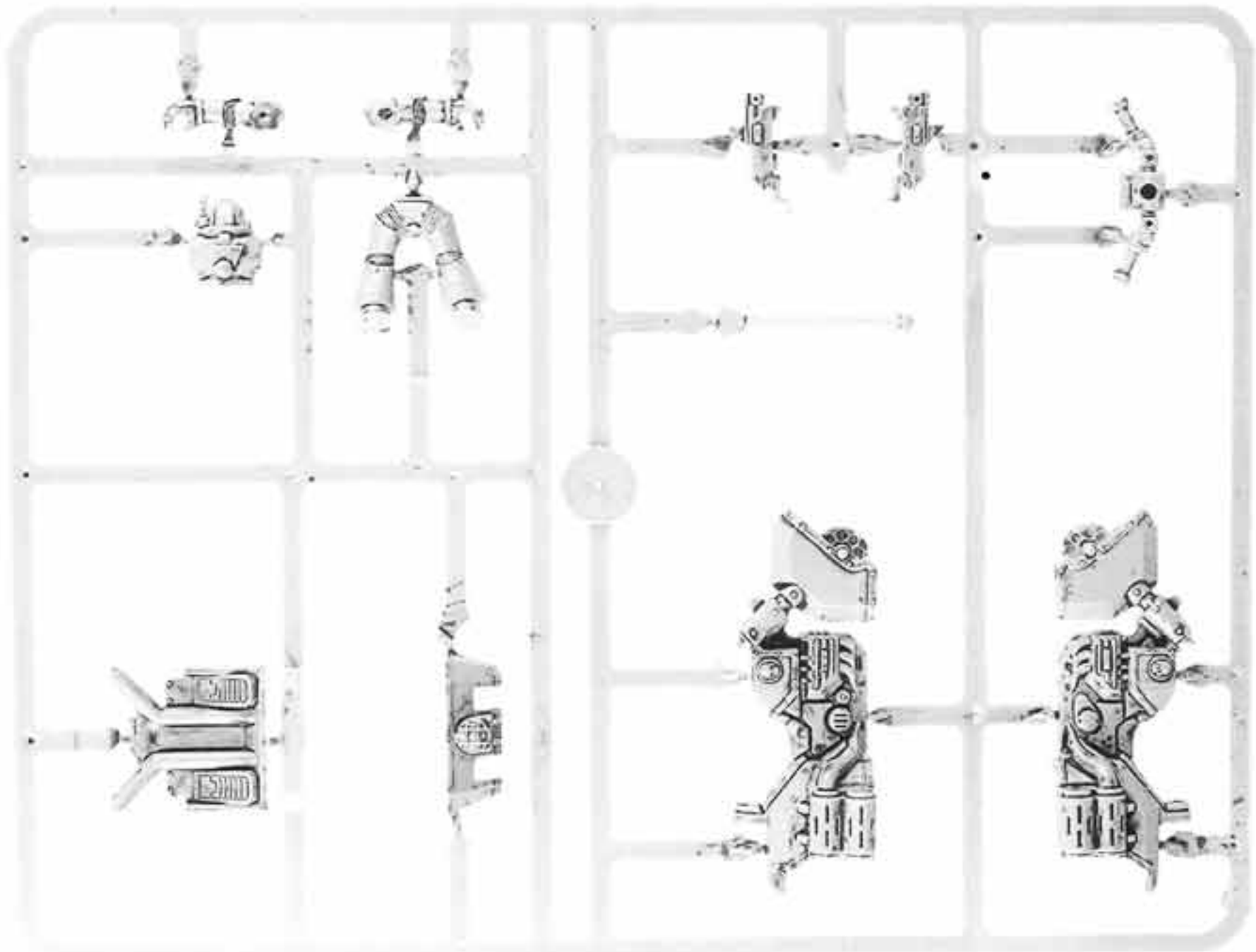

SPACE MARINE BIKE SPRUE (SHOWN AT 80% OF ACTUAL SIZE)
9939999041



Space Marine Bikes designed by Norman Swales, Space Marines designed by Jes Goodwin

Not suitable for children under 8 years due to small parts and essential pointed components. All models supplied unpainted.
© Copyright Games Workshop Ltd. 1998. All rights reserved.

SPACE MARINES®

SPACE MARINE CHAPLAIN ON BIKE



CHAPLAIN BIKE RIDER
010107603

- A COMPLETED SPACE MARINE CHAPLAIN ON BIKE CONSISTS OF:**
- 1 x CHAPLAIN BIKE RIDER
 - 1 x CHAPLAIN ON BIKE FAIRING
 - 1 x SPACE MARINE BIKE SPRUE
 - 2 x SMALL WHEEL SPRUES
 - 1 x SPACE MARINE BACKPACK SPRUE
 - 1 x SHEET OF PENNANTS
 - 3 x SHEET OF TRANSFERS
 - 1 x CHAPLAIN ON BIKE EQUIPMENT SPRUE



CHAPLAIN ON BIKE FAIRING
010107602



SPACE MARINE CHAPLAIN ON BIKE

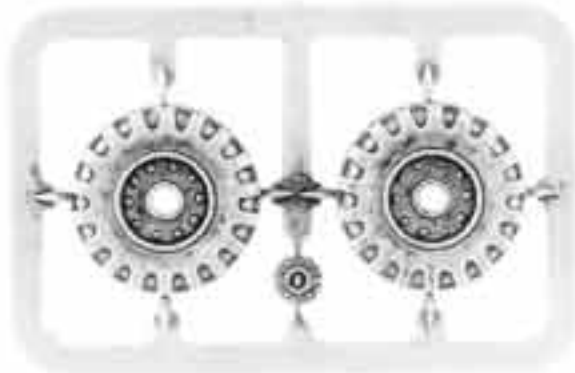

SMALL WHEEL SPRUE
(SHOWN AT 90% OF ACTUAL SIZE)
99399999034

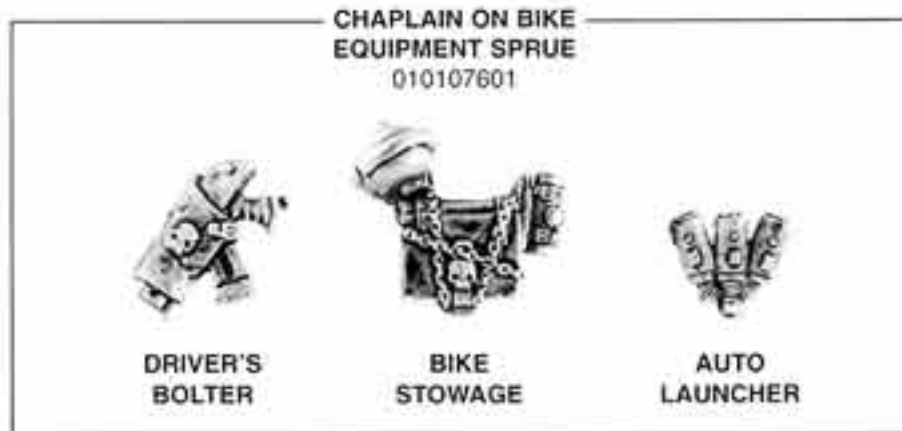

CHAPLAIN ON BIKE EQUIPMENT SPRUE
010107601

DRIVER'S BOLTER

BIKE STOWAGE

AUTO LAUNCHER

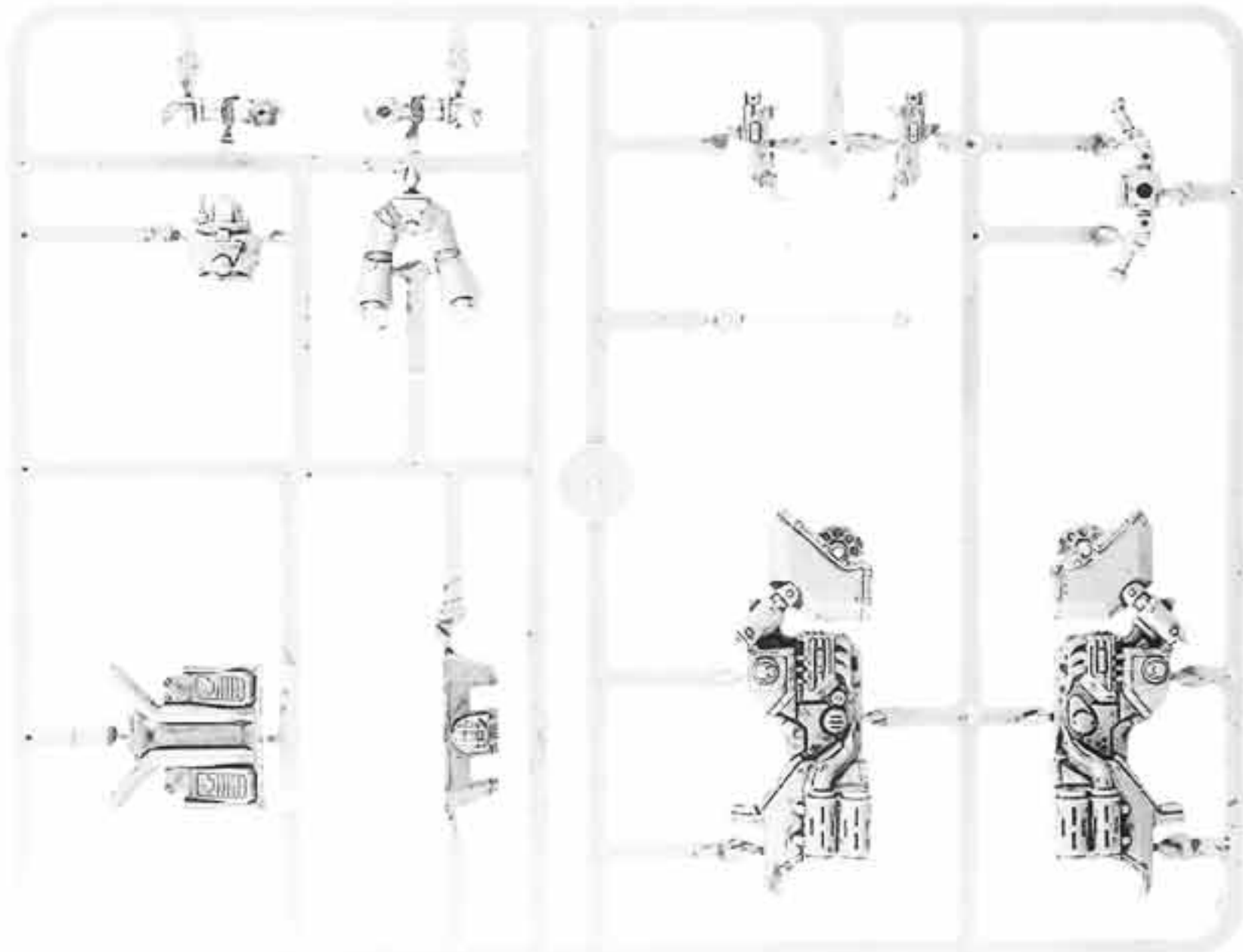

SPACE MARINE BIKE SPRUE (SHOWN AT 75% OF ACTUAL SIZE)
99399999041



SPACE MARINES®

SPACE MARINE BIKE SQUADRON

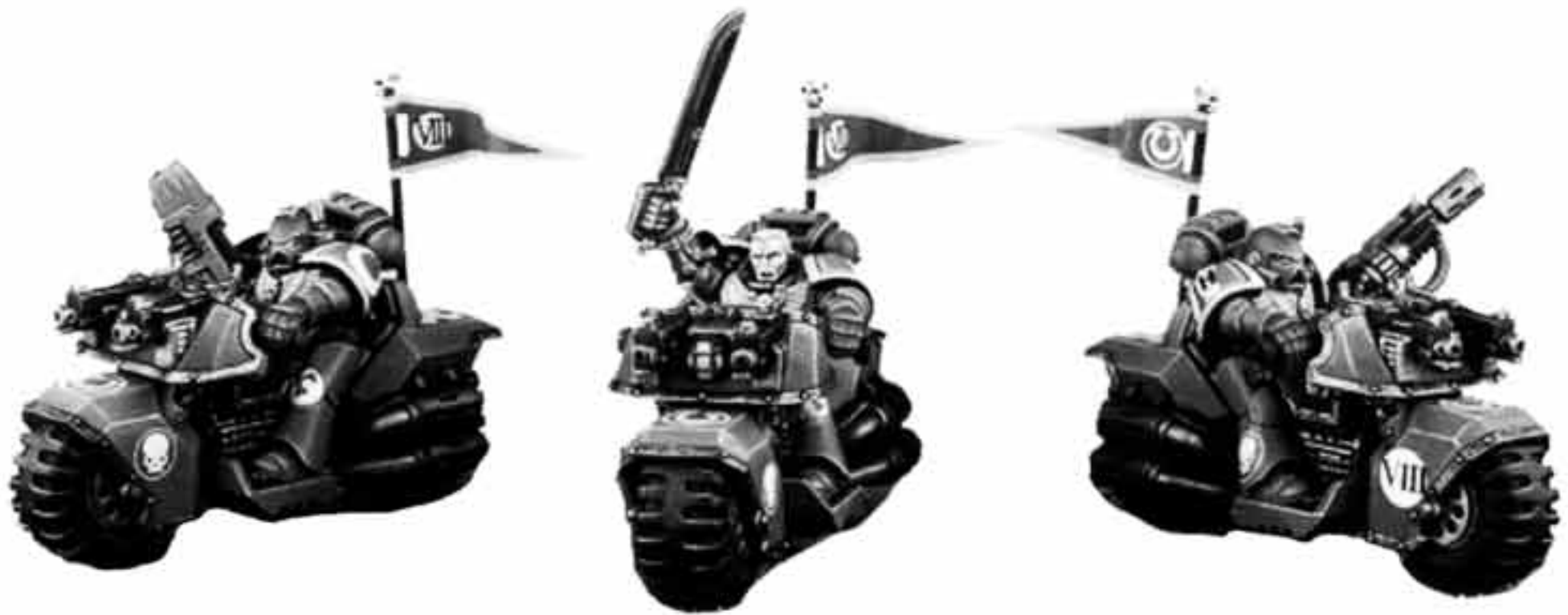

A SPACE MARINE BIKE SQUADRON



SPACE MARINE SERGEANT
BIKER BODY
010105601



SPACE MARINE BIKER BODY
WITH PLASMA GUN
010105602



SPACE MARINE BIKER BODY
WITH MELTA-GUN
010105603

A COMPLETED SPACE MARINE BIKE CONSISTS OF:

- 6 x WHEEL SPRUES
- 3 x SPACE MARINE BIKE SPRUES
- 1 x SPACE MARINE BACKPACK SPRUE
- 3 x SHEETS OF BANNERS
- 4 x SHEETS OF TRANSFERS
- 1 x SPACE MARINE SERGEANT BIKER BODY
- 1 x SPACE MARINE BIKER BODY WITH MELTA-GUN
- 1 x SPACE MARINE BIKER BODY WITH PLASMA GUN

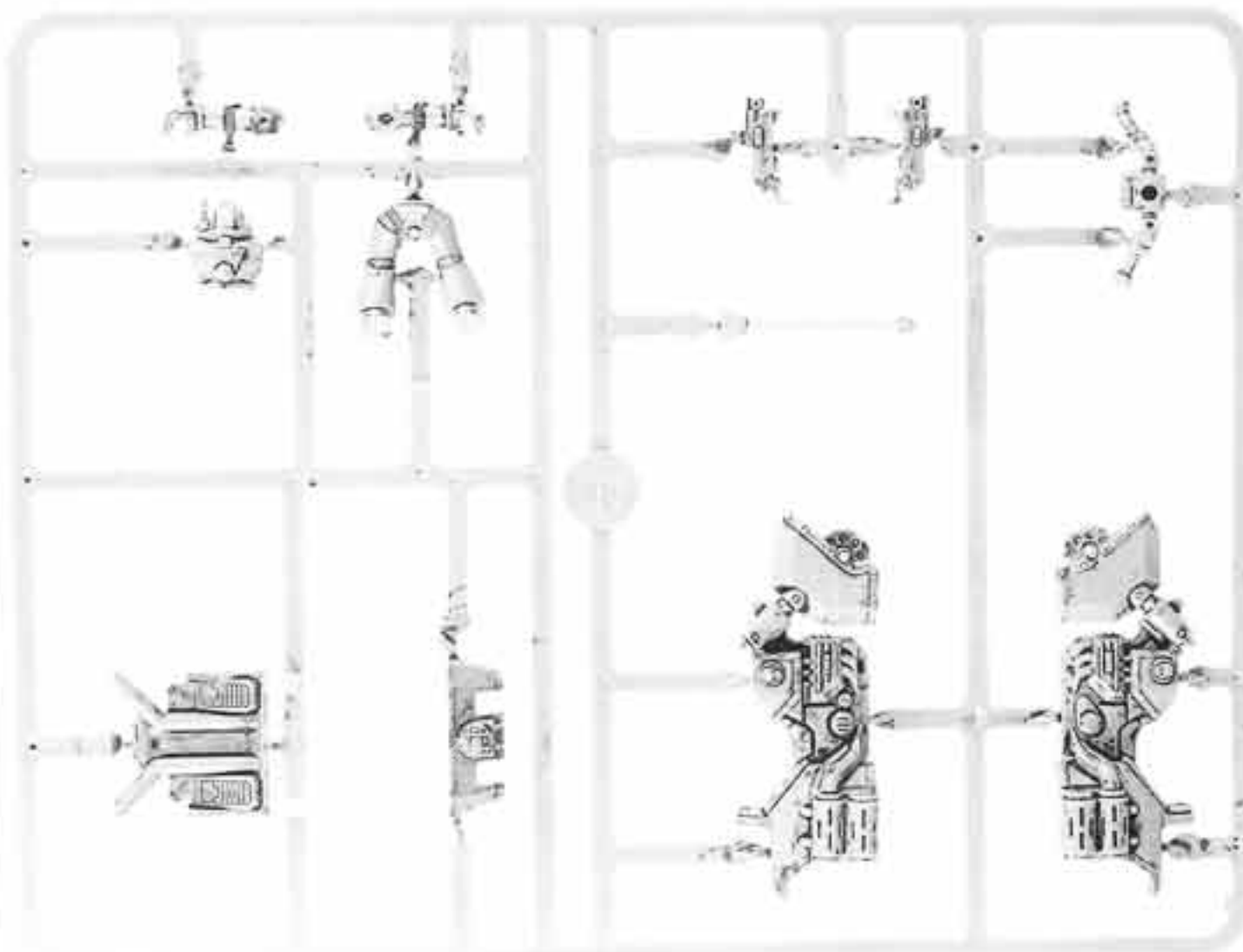

SPACE MARINE BIKE SPRUE (SHOWN AT 65% OF ACTUAL SIZE)
99399999



SMALL WHEEL SPRUE
99399999034



Space Marine Bikes designed by Jes Goodwin

Not suitable for children under 8 years due to small parts and essential pointed components. All models supplied unpainted.
© Copyright Games Workshop Ltd, 1998. All rights reserved.

SPACE MARINES®

SPACE MARINE ATTACK BIKE



SPACE MARINE ATTACK BIKE



ATTACK BIKE CAR GUNNER
010107708



ATTACK BIKE CHAIR BACK
010107702

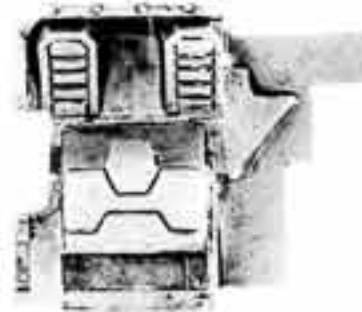

ATTACK BIKE SIDECAR CHASSIS
010107701



ATTACK BIKE SIDECAR MUDGUARD
010107703

- A COMPLETED SPACE MARINE ATTACK BIKE CONSISTS OF:
- 3 x ATTACK BIKE SMALL WHEEL SPRUES
 - 1 x SPACE MARINE BIKE SPRUE
 - 1 x SPACE MARINE BACKPACK SPRUE
 - 4 x SHEETS OF TRANSFERS
 - 1 x ATTACK BIKE SIDECAR GUNNER
 - 1 x ATTACK BIKE HEAVY WEAPON
 - 1 x ATTACK BIKE SIDECAR CHASSIS
 - 1 x ATTACK BIKE SIDECAR MUDGUARD
 - 1 x ATTACK BIKE CHAIR BACK
 - 1 x ATTACK BIKE SIDECAR HUBCAP
 - 1 x ATTACK BIKE EQUIPMENT SPRUE

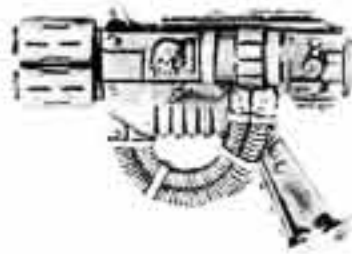

ATTACK BIKE MULTI-MELTA
010107705



ATTACK BIKE HEAVY BOLTER
010107706

ATTACK BIKE EQUIPMENT SPRUE 010107704



DRIVER'S BOLTER



BIKE STOWAGE



AUTO-LAUNCHER

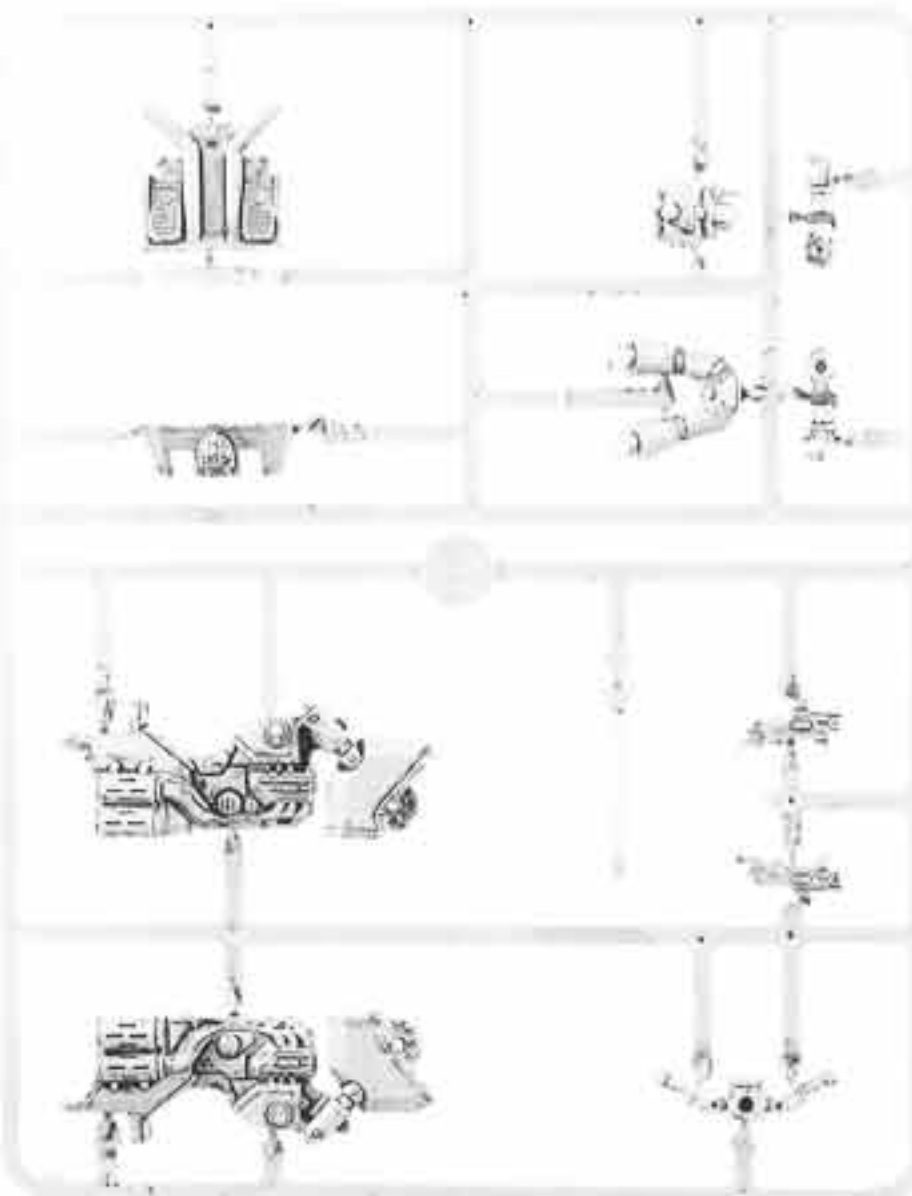

SPACE MARINE BIKE SPRUE (SHOWN AT 55% OF ACTUAL SIZE)
99399999041



ATTACK BIKE SMALL WHEEL SPRUE
(SHOWN AT 55% OF ACTUAL SIZE)
99399999034



ATTACK BIKE SIDECAR HUBCAP
010107707



SPACE MARINES®

SPACE MARINE LAND SPEEDER

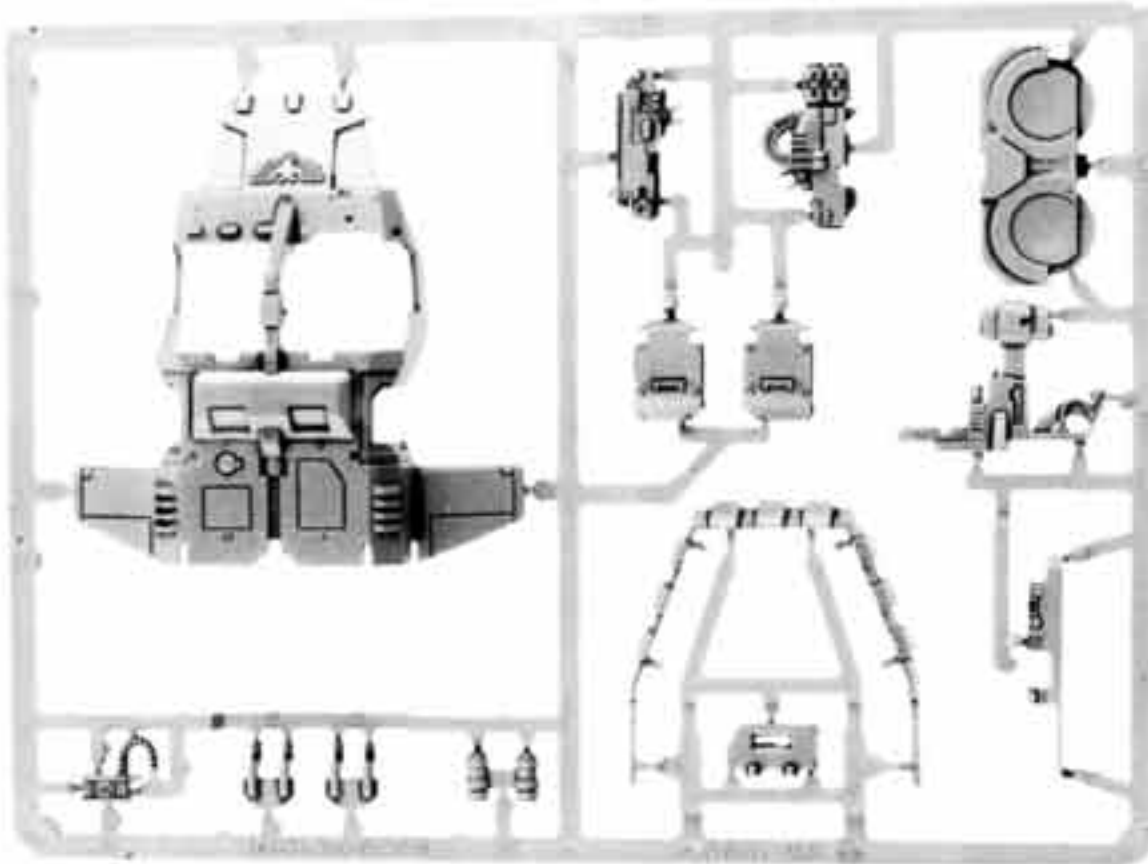
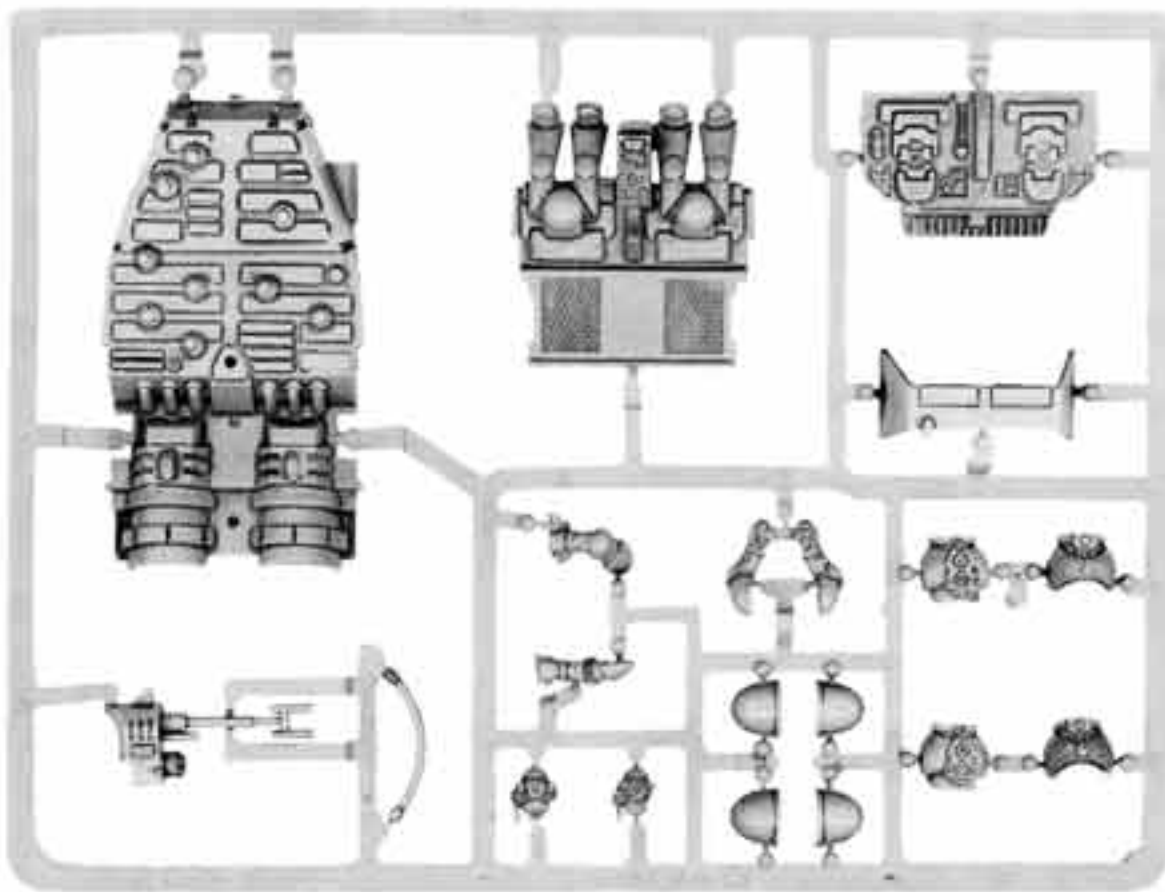

SPACE MARINE LAND SPEEDER SPRUE (SHOWN AT 50% OF ACTUAL SIZE)

99390101001

PLEASE NOTE THAT THE SPACE MARINE LAND SPEEDER IS SUPPLIED AS A SINGLE SPRUE

A COMPLETE SPACE MARINE LAND SPEEDER CONSISTS OF:

- 1 x SPACE MARINE LANDSPEEDER SPRUE
- 1 x 40K SWIVEL FLYING BASE
- 1 x LARGE FLYING STAND



40K SWIVEL FLYING BASE
99399999062
SHOWN ACTUAL SIZE



40K SWIVEL FLYING BASE COMPLETE

THE SPACE MARINE LANDSPEEDER COMES SUPPLIED WITH A 40K SWIVEL FLYING BASE THAT ALLOWS YOU TO POSITION YOUR LAND SPEEDER MODEL IN A VARIETY OF DIFFERENT WAYS



Designed by Jes Goodwin

SPACE MARINES

SPACE MARINE RHINO

A COMPLETE
SPACE MARINE RHINO
CONSISTS OF:
2 x RHINO CHASSIS SPRUE
2 x RHINO TRACK SPRUE

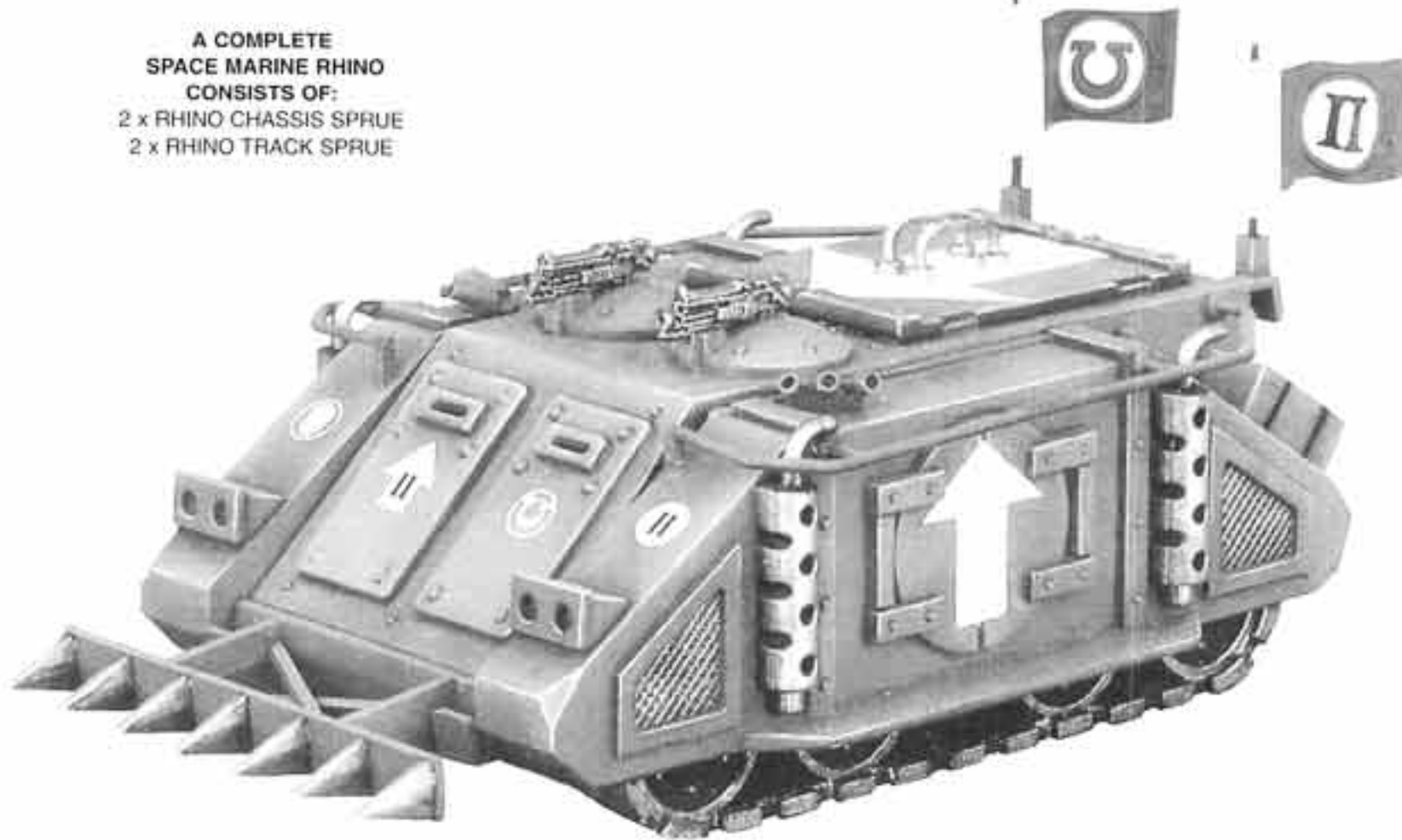

AN EXAMPLE OF A COMPLETED RHINO IN THE COLOURS OF THE ULTRAMARINES CHAPTER OF SPACE MARINES



SPACE MARINES

SPACE MARINE RHINO

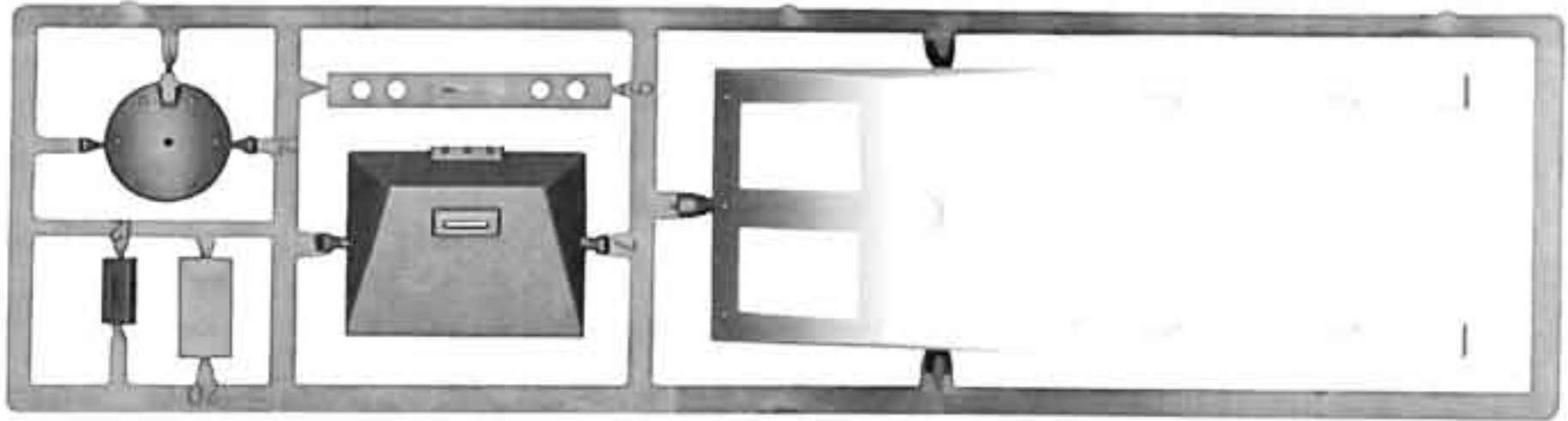

RHINO CHASSIS SPRUE
99399999055
SHOWN AT 70% ACTUAL SIZE

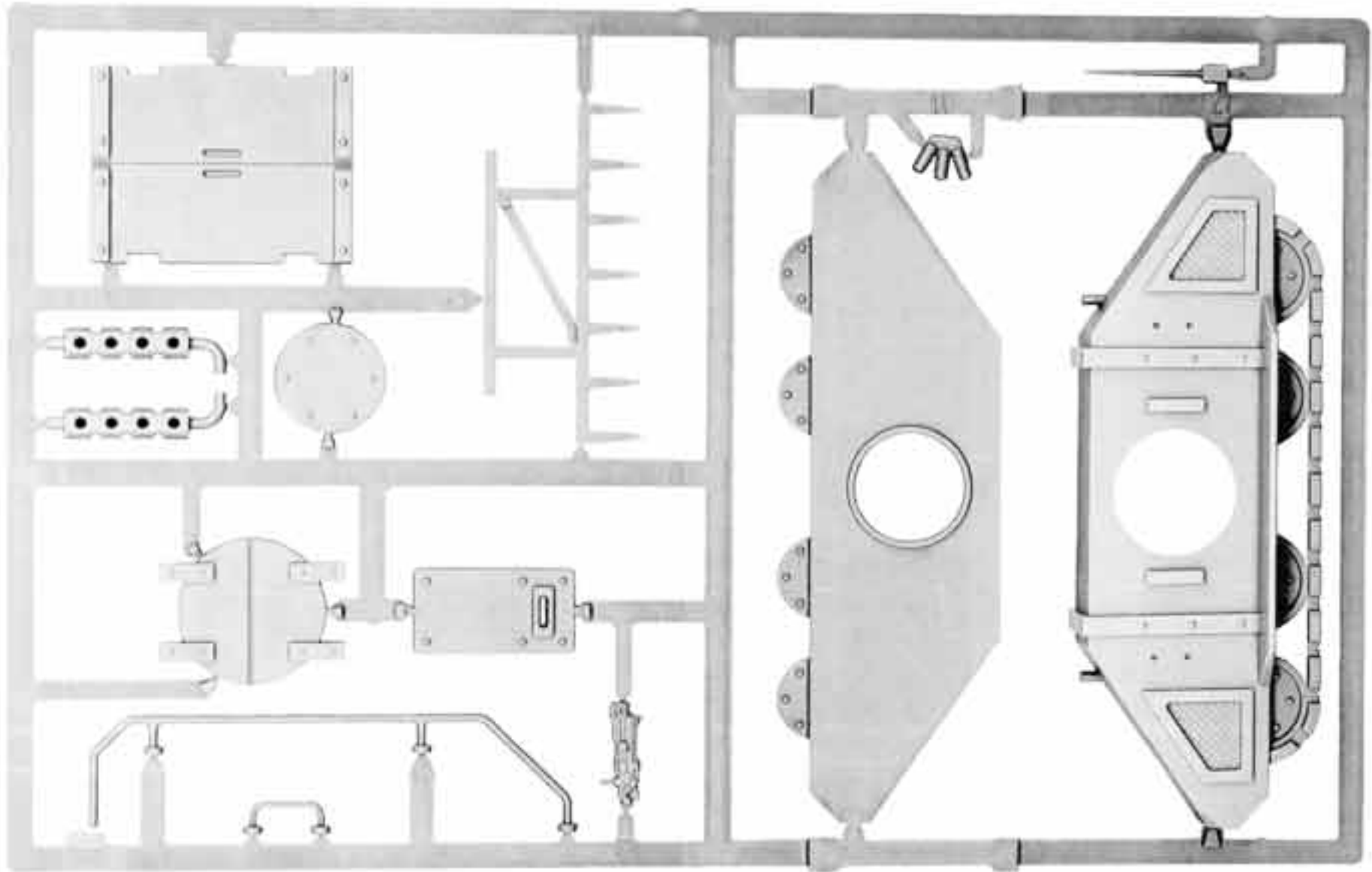

RHINO TRACK SPRUE
99399999054
SHOWN AT 70% ACTUAL SIZE



SPACE MARINES

RAZORBACK



EXAMPLE OF AN ASSEMBLED SPACE MARINE RAZORBACK PAINTED IN THE COLOURS OF THE ULTRAMARINES



TOP PLATE
010105202

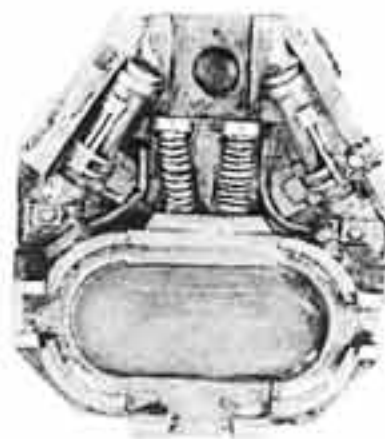

TURRET
010105203

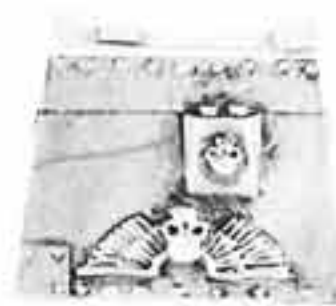

GUN SHIELD
010105204

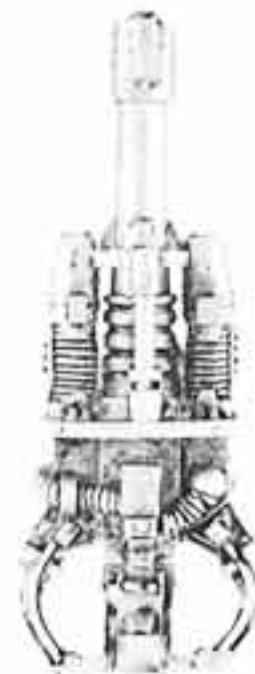

RAZORBACK GUN
010105205



MIDDLE HATCH
010105206



LEFT HATCH
010105207



GUNNER
010105201



RIGHT HATCH
010105208

THE COMPLETE SPACE MARINE RAZORBACK CONSISTS OF :

- 2 x RHINO CHASSIS SPRUE
- 2 x RHINO TRACK SPRUE
- 1 x GUNNER
- 1 x LEFT HATCH
- 1 x RIGHT HATCH
- 1 x MIDDLE HATCH
- 1 x RAZORBACK GUN
- 1 x GUN SHIELD
- 1 x TURRET
- 1 x TOP PLATE

THIS MODEL INCLUDES A DETAILED CONSTRUCTION SHEET AND FIVE CITADEL TRANSFER SHEETS WHICH INCLUDE ALL THE MARKINGS NEEDED FOR THE DARK ANGELS, ULTRAMARINES, SPACE WOLVES AND BLOOD ANGELS CHAPTERS.

SPACE MARINE

SPACE MARINE PREDATOR

A COMPLETED EXAMPLE OF A SPACE MARINE PREDATOR

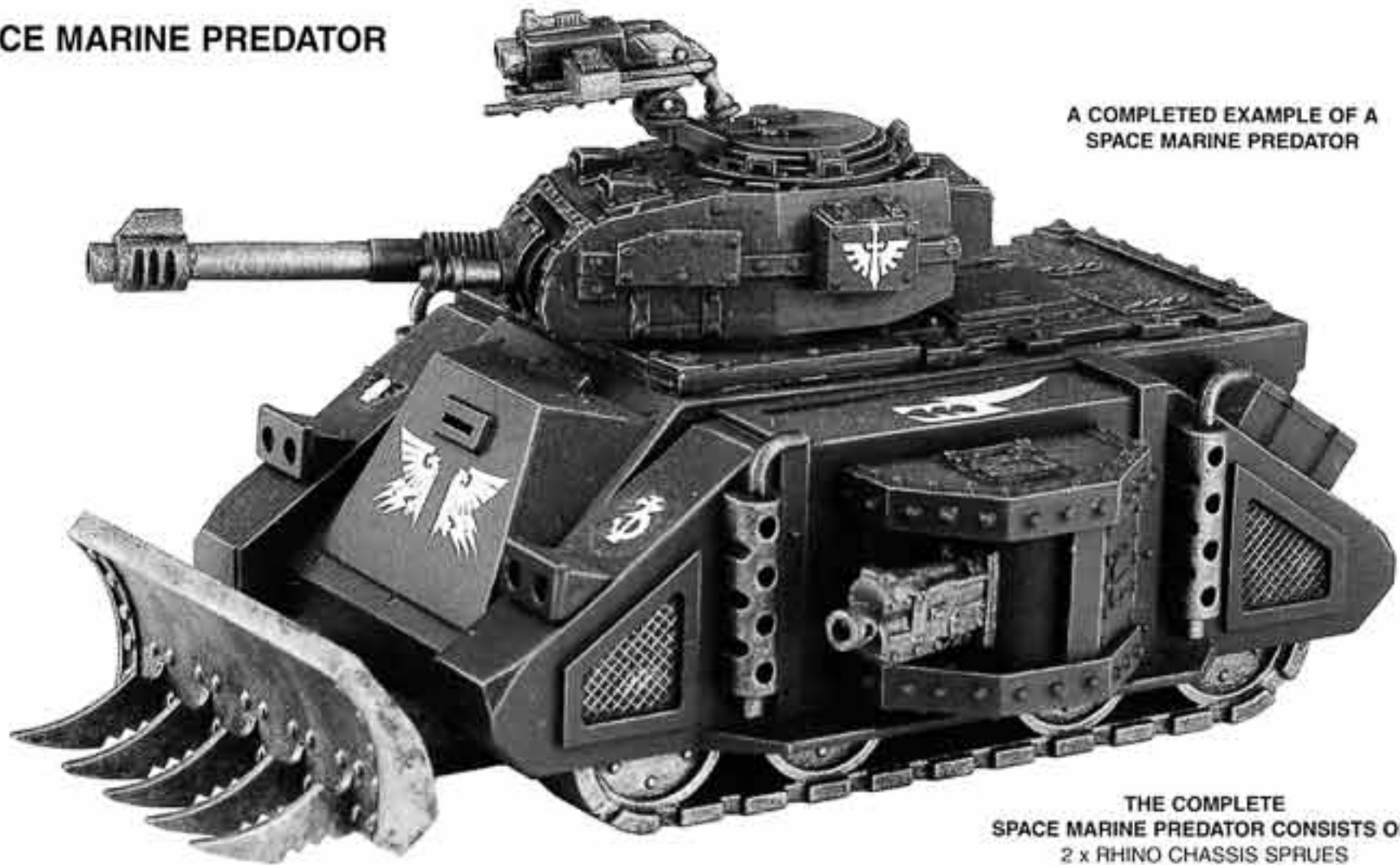

THE COMPLETE SPACE MARINE PREDATOR CONSISTS OF:

- 2 x RHINO CHASSIS SPRUES
- 2 x RHINO TRACK SPRUES
- 1 x PLASTIC ACCESSORY SPRUE FRAME A
- 2 x SPONSON LASCANNONS
- 2 x SPONSON HEAVY BOLTERS
- 2 x SPONSON PLATES
- 1 x HATCH LID 1
- 1 x HATCH LID 2
- 2 x SPONSON SIDE PLATES
- 2 x SPONSON PLATES A
- 2 x SPONSON PLATES B
- 2 x SPONSON WEAPON MOUNTS
- 1 x AUTOCANNON
- 1 x TURRET TOP
- 1 x TURRET BASE
- 1 x TOP PLATE
- 1 x REAR TOP PLATE



SPONSON PLATE
010105702



SPONSON LASCANNON
010105415



SPONSON HEAVY BOLTER
010105411

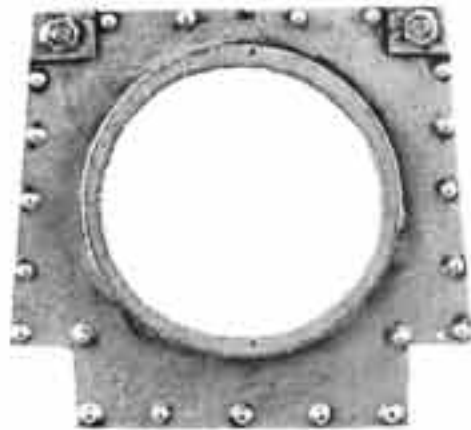

TOP PLATE
010105706



SPONSON SIDE PLATE
010105708



SPONSON PLATE A
010105710

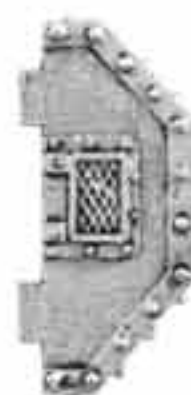

SPONSON PLATE B
010105709



HATCH LID 1
010505304



HATCH LID 2
010505305



CUPOLA
010505303

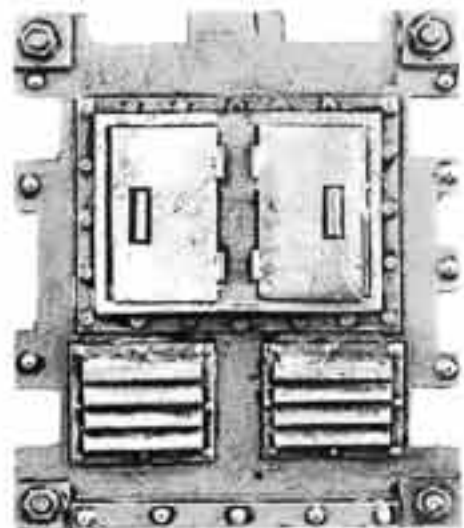

REAR TOP PLATE
010105701



AUTOCANNON
010105412



TURRET BASE
010105413



TURRET TOP
010105414



SPONSON WEAPON MOUNT
010105707

THIS MODEL INCLUDES A DETAILED CONSTRUCTION BOOK AND FIVE CITADEL TRANSFER SHEETS WHICH INCLUDE ALL THE MARKINGS NEEDED FOR THE DARK ANGELS, ULTRAMARINES, SPACE WOLVES AND BLOOD ANGELS CHAPTERS.

Designed by Norman Swales

Not suitable for children under 36 months due to small parts and essential pointed components. All models supplied unpainted.
© Copyright Games Workshop Ltd., 1997. All rights reserved.

SPACE MARINES

SPACE MARINE PREDATOR ANNIHILATOR



A COMPLETE SPACE MARINE PREDATOR ANNIHILATOR CONSISTS OF:

- 2 x RHINO CHASSIS SPRUES
- 2 x RHINO TRACK SPRUES
- 1 x PLASTIC ACCESSORY SPRUE
- FRAME A
- 2 x LASCANNONS
- 2 x HEAVY BOLTERS
- 2 x SPONSON PLATES
- 1 x HATCH LID 1
- 1 x HATCH LID 2
- 2 x SPONSON SIDE PLATES
- 2 x SPONSON PLATES A
- 2 x SPONSON PLATES B
- 2 x SPONSON WEAPON MOUNTS
- 1 x TWIN LASCANNON
- 1 x TURRET TOP
- 1 x TURRET BASE
- 1 x TOP PLATE
- 1 x REAR TOP PLATE
- 1 x CUPOLA

A COMPLETED SPACE MARINE PREDATOR ANNIHILATOR



LASCANNON
010105415



HEAVY BOLTER
010105411



HATCH LID 1
010505304



HATCH LID 2
010505305



CUPOLA
010505303

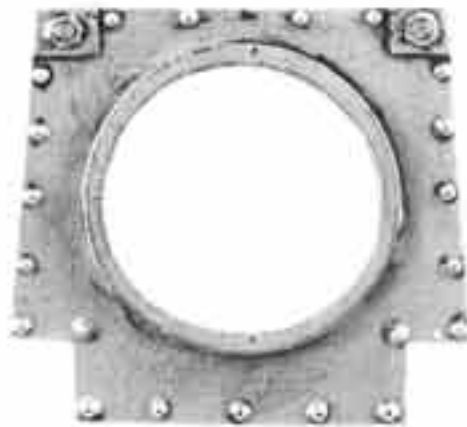

TOP PLATE
010105706



SPONSON SIDE PLATE
010105708

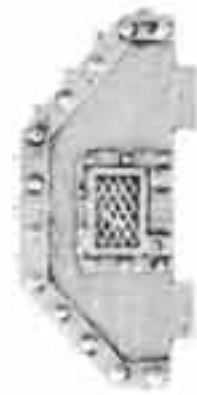

SPONSON PLATE A
010105710



SPONSON PLATE B
010105709



SPONSON PLATE
010105702

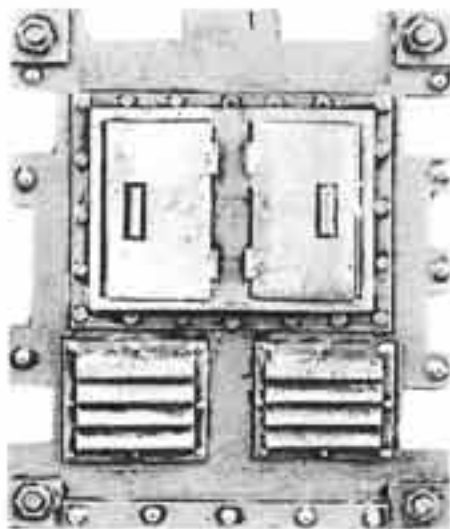

REAR TOP PLATE
010105701



TWIN LASCANNON
010105516



TURRET BASE
010105517



TURRET TOP
010105518



SPONSON WEAPON MOUNT
010105707

THIS MODEL INCLUDES A DETAILED CONSTRUCTION BOOK AND FIVE CITADEL TRANSFER SHEETS TO ENABLE YOU TO COMPLETE YOUR PREDATOR IN EITHER DARK ANGELS, ULTRAMARINES, SPACE WOLVES OR BLOOD ANGELS CHAPTER COLOURS AND MARKINGS.



SPACE MARINES

BLOOD ANGELS BAAL PREDATOR



EXAMPLE OF AN ASSEMBLED
BLOOD ANGELS BAAL PREDATOR

- THE COMPLETE BLOOD ANGELS
BAAL PREDATOR
CONSISTS OF :
- 2 x RHINO CHASSIS SPRUE
 - 2 x RHINO TRACK SPRUE
 - 1 x GUNNER
 - 1 x GUNNER'S ARMS
 - 2 X HEAVY FLAMER
 - 2 x FUEL TANK
 - 1 x LEFT ASSAULT CANNON
 - 1 x RIGHT ASSAULT CANNON
 - 1 x TURRET TOP
 - 1 x TURRET BOTTOM
 - 1 x GUN PORTS
 - 1 x FRONT ARMOUR PLATE
 - 2 x SPONSON PLATE A
 - 2 x SPONSON PLATE B
 - 2 x SPONSON WEAPON MOUNT
 - 2 x SPONSON SIDE PLATE
 - 1 x REAR TOP PLATE
 - 1 x TOP PLATE
 - 2 x SPONSON PLATE
 - 1 x HATCH LID 1
 - 1 x HATCH LID 2
 - 1 x CUPOLA
 - 1 x VEHICLE ACCESSORY SPRUE



HATCH LID 1
010505304



HATCH LID 2
010505305



CUPOLA
010505303



FRONT ARMOUR PLATE
01017506



LEFT ASSAULT CANNON
01017501



GUN PORTS
01017503

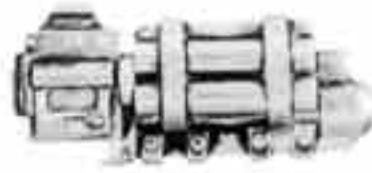

RIGHT ASSAULT CANNON
01017502



GUNNER
01017508

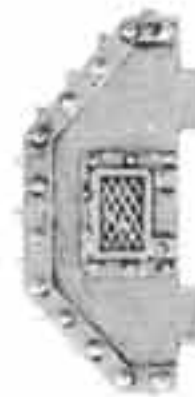

SPONSON PLATE A
010105710



SPONSON PLATE B
010105709



FUEL TANK
01017505

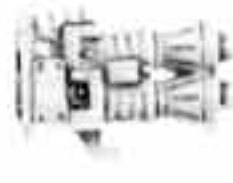

HEAVY FLAMER
01017504



GUNNER'S ARMS
01017507



SPONSON WEAPON
MOUNT
010105707

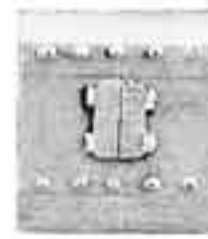

SPONSON SIDE
PLATE
010105708



SPONSON PLATE
010105702

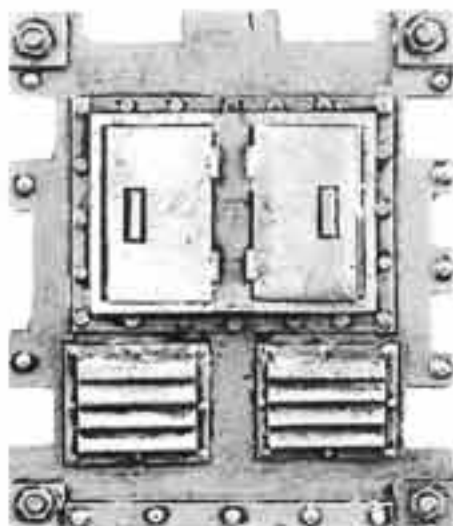

REAR TOP PLATE
010105701



TOP PLATE
010105706



TURRET TOP
010105518



TURRET BOTTOM
010105517

Designed by Norman Swales and Jes Goodwin

Not suitable for children under 8 years due to small parts and essential pointed components. All models supplied unpainted.
© Copyright Games Workshop Ltd. 1998. All rights reserved.



SPACE MARINE®

WHIRLWIND

THE COMPLETE
SPACE MARINE WHIRLWIND
CONSISTS OF:

- 2 x RHINO CHASSIS SPRUE
- 2 x RHINO TRACK SPRUE
- 1 x WHIRLWIND TURRET
- 1 x SCANNER
- 1 x SCANNER BASE
- 1 x WHIRLWIND TOP PLATE
- 1 x ROCKET SUPPORT ARMS
- 2 x WARHEADS
- 2 x ROCKET TUBES
- 2 x EXHAUST VENTS

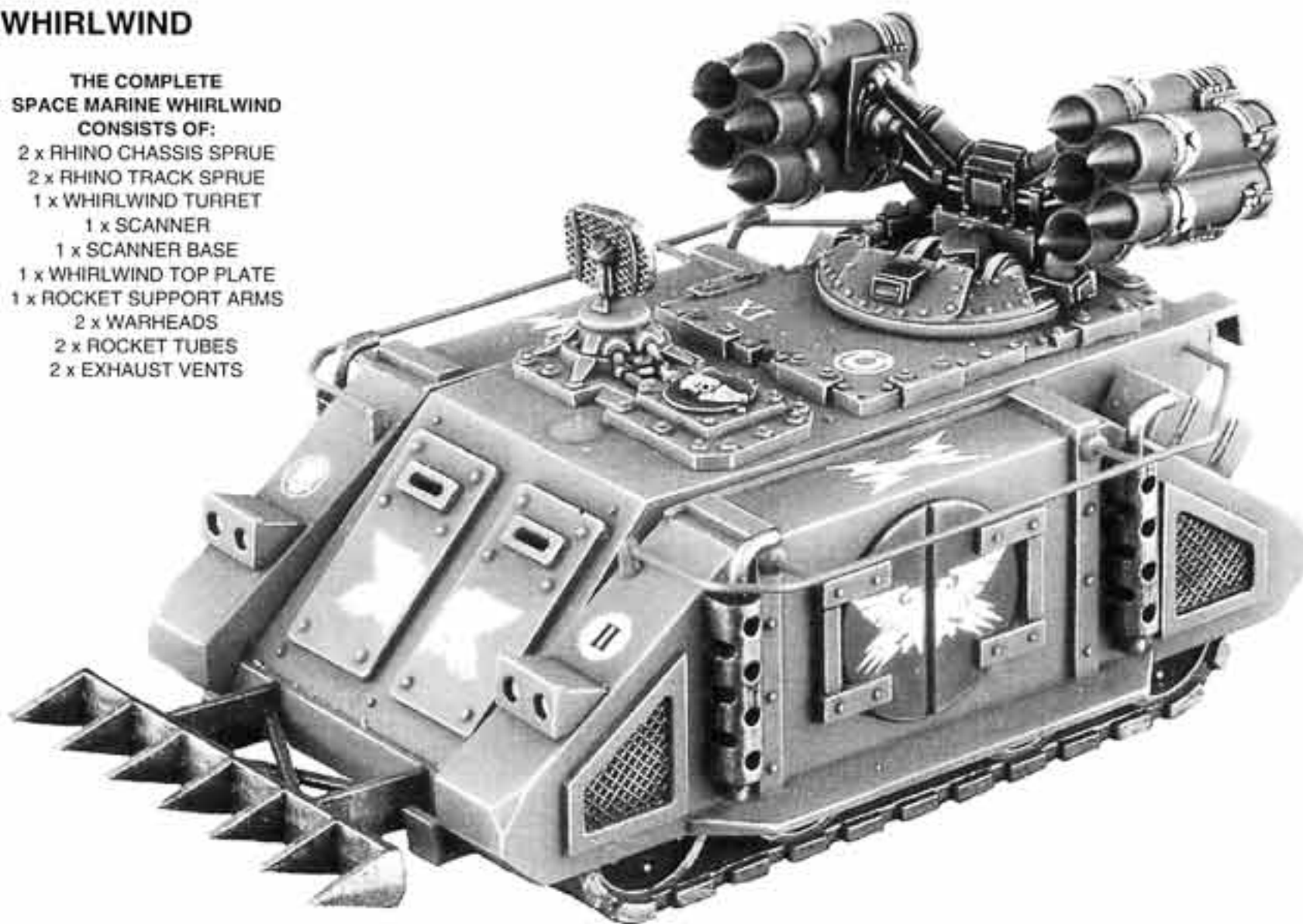

SPACE MARINE WHIRLWIND



EXHAUST VENTS
010105308

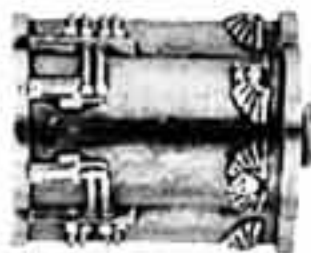

ROCKET TUBES
010105304



WARHEADS
010105307

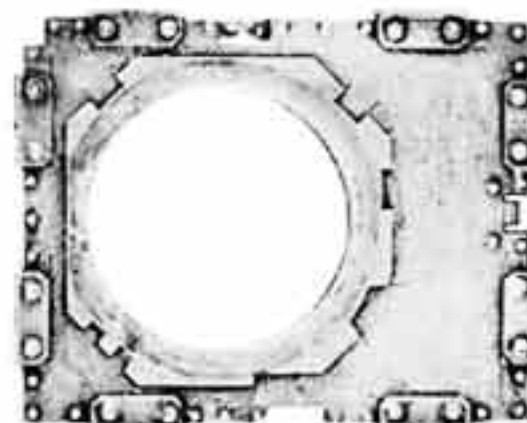

WHIRLWIND TOP PLATE
010105306

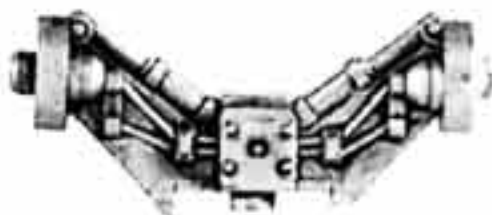

ROCKET SUPPORT ARMS
010105305



SCANNER
010105303



WHIRLWIND TURRET
010105301



SCANNER BASE
010105302

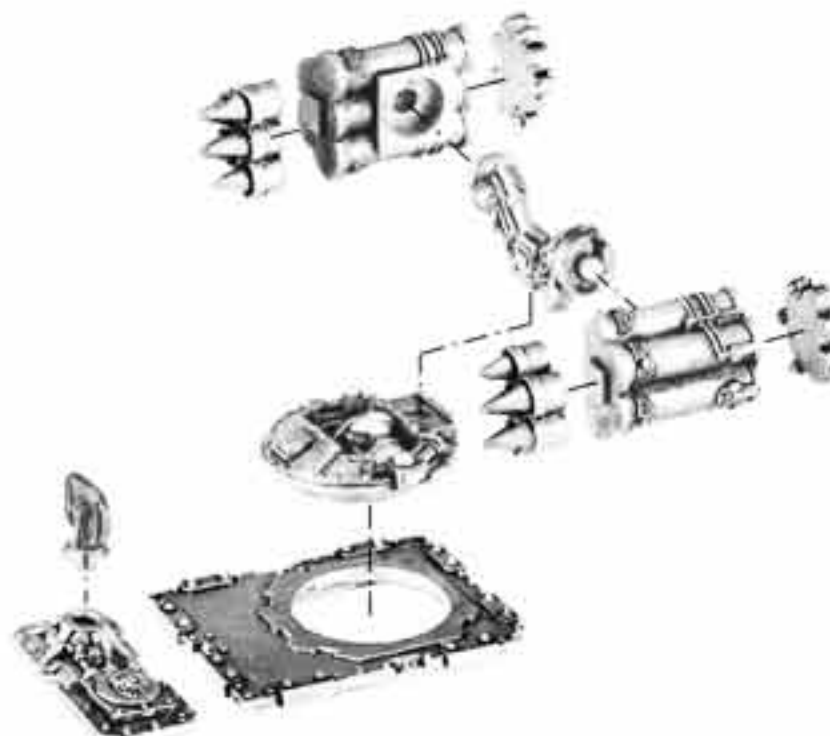

THIS BOXED SET INCLUDES A DETAILED CONSTRUCTION SHEET AND FIVE CITADEL TRANSFER SHEETS WHICH INCLUDE ALL THE MARKINGS NEEDED FOR THE DARK ANGELS, ULTRAMARINES, SPACE WOLVES AND BLOOD ANGELS SPACE MARINE CHAPTERS.



CITADEL
MINIATURES



CITADEL
MINIATURES

DARK ELDAR

DARK ELDAR WARRIORS

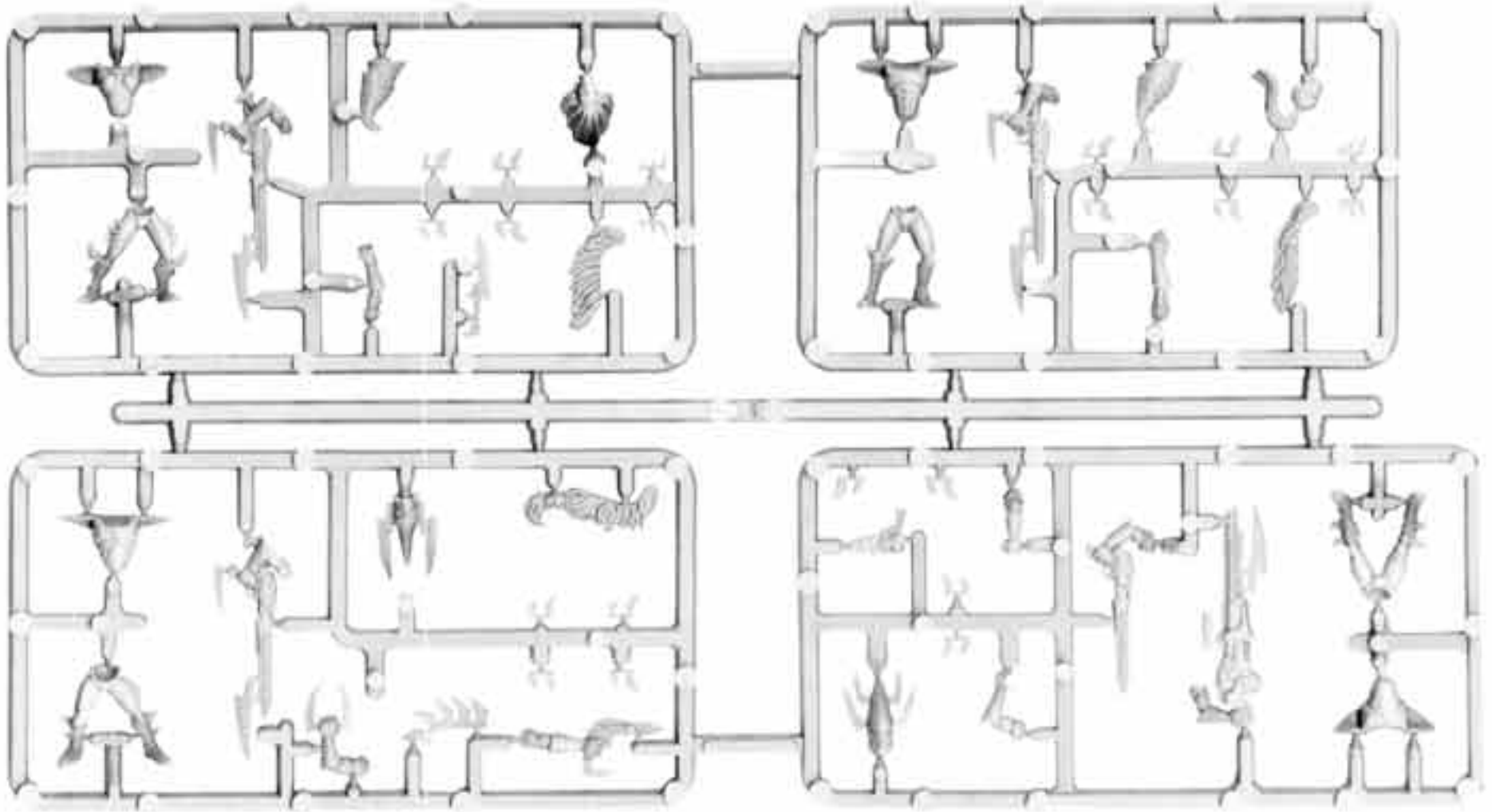

DARK ELDAR WARRIORS SPRUE
99380112001
(SHOWN AT 60% OF ACTUAL SIZE)



SHOWN BELOW ARE ONLY A FEW EXAMPLES OF THE MANY POSSIBLE WAYS
YOU CAN ASSEMBLE YOUR DARK ELDAR WARRIORS



DARK ELDAR WARRIORS



Designed by Gary Morley

Not suitable for children under 8 years due to small parts and essential pointed components. All models supplied unpainted.
© Copyright Games Workshop Ltd. 1998. All rights reserved.

DARK ELDAR

DARK ELDAR HAEMONCULUS



HAEMONCULUS 1
011200301



HAEMONCULUS 2
011200302



URIEN RAKARTH
MASTER HAEMONCULUS
011200701

DARK ELDAR SYBARITES



DARK ELDAR SYBARITE 1
011200201



DARK ELDAR SYBARITE 2
011200202

DARK ELDAR LORD



DARK ELDAR LORD BODY
011200901



DARK ELDAR LORD ARM
011200902

DARK ELDAR WITH SPLINTER CANNON



DARK ELDAR
WITH SPLINTER CANNON 1
011200401



DARK ELDAR
WITH SPLINTER CANNON 2
011200402



DARK ELDAR LORD COMPLETE



DARK ELDAR

DARK ELDAR INCUBI



INCUBI 1
011200601



INCUBI 2
011200602



INCUBI 3
011200603

DARK ELDAR INCUBI WITH ASSAULT WEAPONS



INCUBI WITH
ASSAULT WEAPON 1
011201001



INCUBI WITH
ASSAULT WEAPON 2
011201002



INCUBI BACKPACK 1
011200605



INCUBI BACKPACK 2
011200606



INCUBI BACKPACK 3
011200607



INCUBI BLASTER
011201004



INCUBI SHREDDER
011201003

A COMPLETE DARK ELDAR INCUBI
CONSISTS OF:
1 x INCUBI
1 x INCUBI BACKPACK

A COMPLETE DARK ELDAR INCUBI WITH
ASSAULT WEAPON
CONSISTS OF:
1 x INCUBI WITH ASSAULT WEAPON
1 x INCUBI BACKPACK
AND EITHER
1 x INCUBI BLASTER OR
1 x INCUBI SHREDDER



DARK ELDAR INCUBI



DARK ELDAR INCUBI WITH
ASSAULT WEAPON

DARK ELDAR

DARK ELDAR WYCHES

PLEASE NOTE THAT THE DARK ELDAR WYCH SHOULDER PADS ARE NOT INTERCHANGEABLE. FOR INSTANCE DARK ELDAR WYCH SHOULDER PAD 3 WILL NOT FIT DARK ELDAR WYCH 4 AND SO ON.



DARK ELDAR SUCCUBI
011200101



DARK ELDAR SUCCUBI
SHOULDER
011200102



DARK ELDAR WYCH WITH
SHREDDER
011200103



DARK ELDAR WYCH
SHOULDER 2
011200104



DARK ELDAR WYCH 3
011200105



DARK ELDAR WYCH
SHOULDER 3
011200106



DARK ELDAR WYCH 4
011200107



DARK ELDAR WYCH 4
GUN ARM
011200108



DARK ELDAR WYCH
SHOULDER 4
011200109



DARK ELDAR WYCH 5
011200110



DARK ELDAR WYCH
SHOULDER 5
011200111



DARK ELDAR WYCHES COMPLETE



DARK ELDAR

DARK ELDAR WARP BEASTS



WARP BEAST 1
011200501



FRONT LEG 1
011200502



HIND LEG 1
011200503

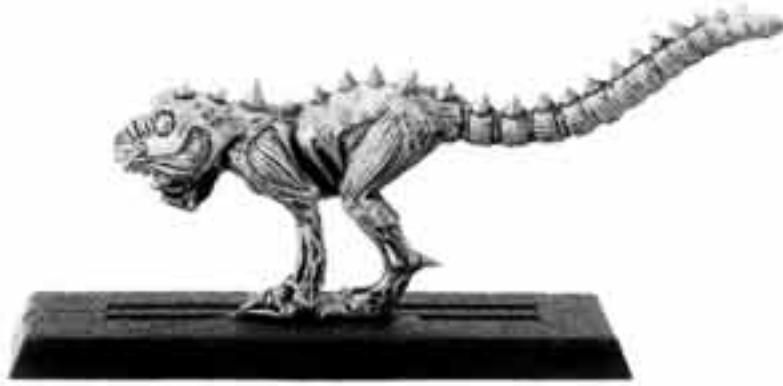

WARP BEAST 2
011200504



FRONT LEG 2
011200505



HIND LEG 2
011200506



WARP BEAST 3
011200507



FRONT LEG 3
011200508



HIND LEG 3
011200509

PLEASE NOTE THAT THESE COMPONENTS ARE NOT INTERCHANGEABLE WITH EACH OTHER



DARK ELDAR BEASTMASTER
011200801

A COMPLETE
DARK ELDAR WARP BEAST
CONSISTS OF:
1 x DARK ELDAR
WARP BEAST BODY
1 x FRONT LEG
1 x HIND LEG



COMPLETED
DARK ELDAR WARP BEAST

Warpbeasts designed by Trish Morrison Beastmaster designed by Chris Fitzpatrick

Not recommended for children under 8 years due to small parts and essential pointed components. All models supplied unpainted.
© Copyright Games Workshop Ltd. 1998. All rights reserved.



DARK ELDAR

DARK ELDAR RAIDER

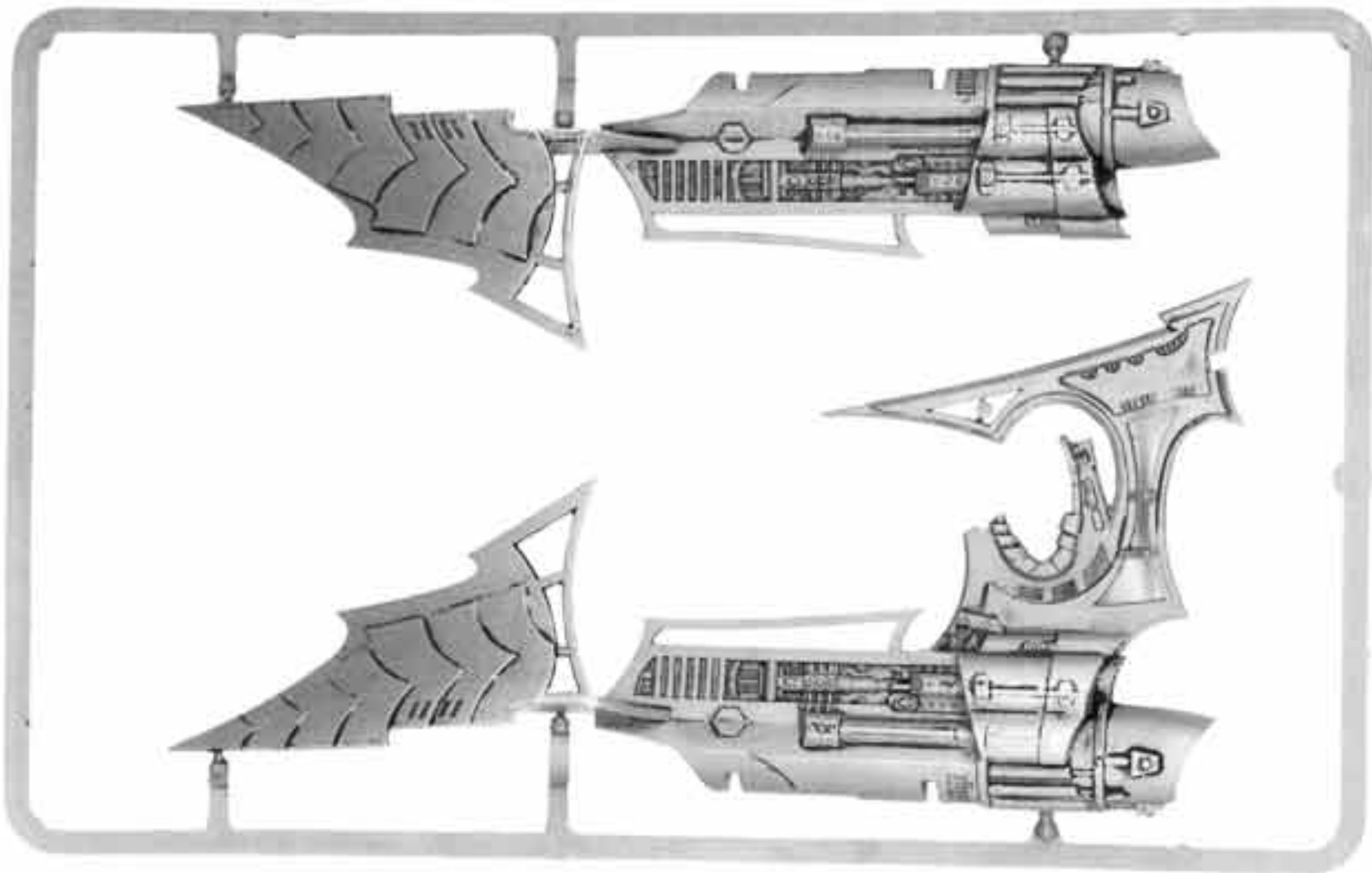

DARK ELDAR RAIDER SPRUE 1
99390112002
(SHOWN AT 65% OF ACTUAL SIZE)

A COMPLETE DARK ELDAR RAIDER CONSISTS OF:

- 1 x DARK ELDAR RAIDER BODY SPRUE
- 1 x DARK ELDAR RAIDER BODY SPRUE 2
- 1 x DARK ELDAR RAIDER CREW SPRUE



Designed by Tim Adcock and Gary Morley

DARK ELDAR

DARK ELDAR REAVER JETBIKE

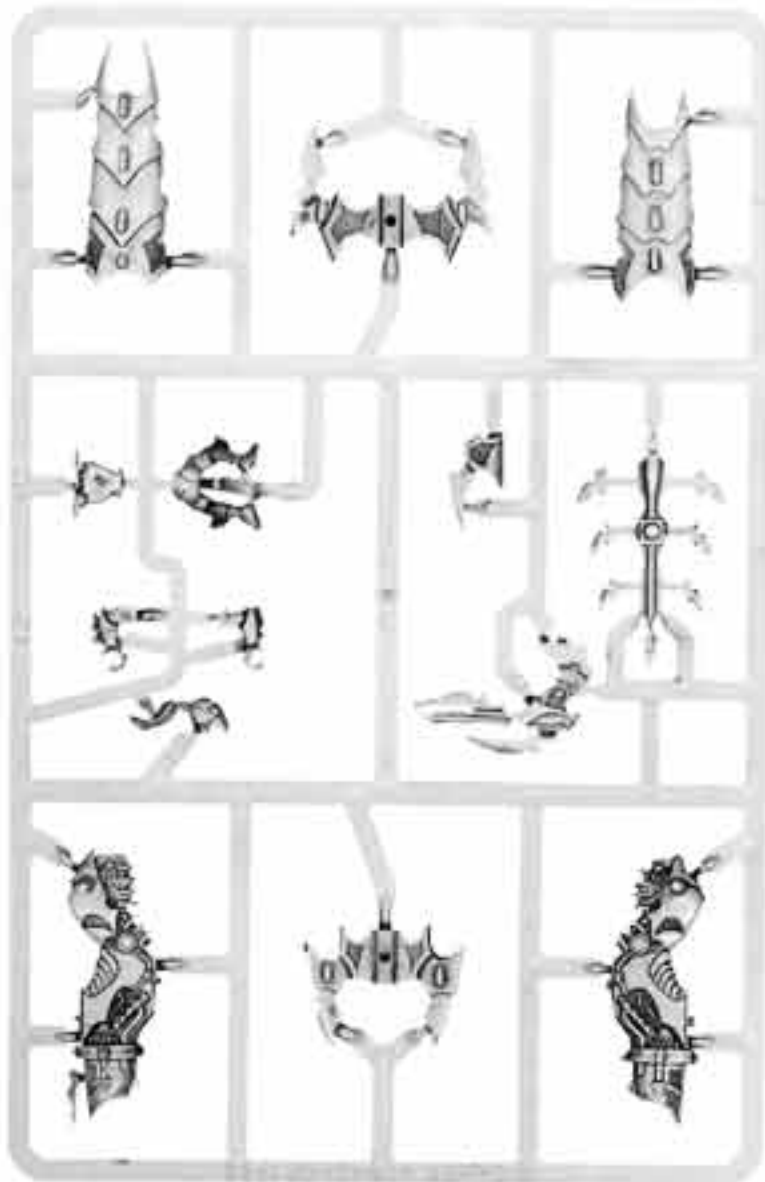

A COMPLETE DARK ELDAR REAVER JETBIKE
CONSISTS OF:
1 x DARK ELDAR REAVER JETBIKE SPRUE
1 x FLYING BASE

THE PLASTIC PARTS NEED TO BE ASSEMBLED USING
POLYSTYRENE CEMENT.

THE METAL ACCESSORIES WILL ENABLE YOU TO CREATE
DIFFERENT WEAPON AND CREW VARIANTS FOR YOUR
DARK ELDAR REAVER JETBIKE SQUADS



DARK ELDAR REAVER JETBIKE SPRUE
99390112001
(SHOWN AT 50% OF ACTUAL SIZE)



**DARK ELDAR JETBIKE
SHREDDER**
011202201



**DARK ELDAR JETBIKE
BLASTER**
011202202



**DARK ELDAR
WYCH
TORSO 1**
011202206



**DARK ELDAR
WYCH
TORSO 2**
011202207



DARK ELDAR SUCCUBI
011202203



**DARK ELDAR WYCH
ARM**
011202208



**DARK ELDAR
SUCCUBUS
ARM**
011202204



CHAINS
011202205



TYRANIDS®

PLASTIC TERMAGANTS



TYRANID TERMAGANT

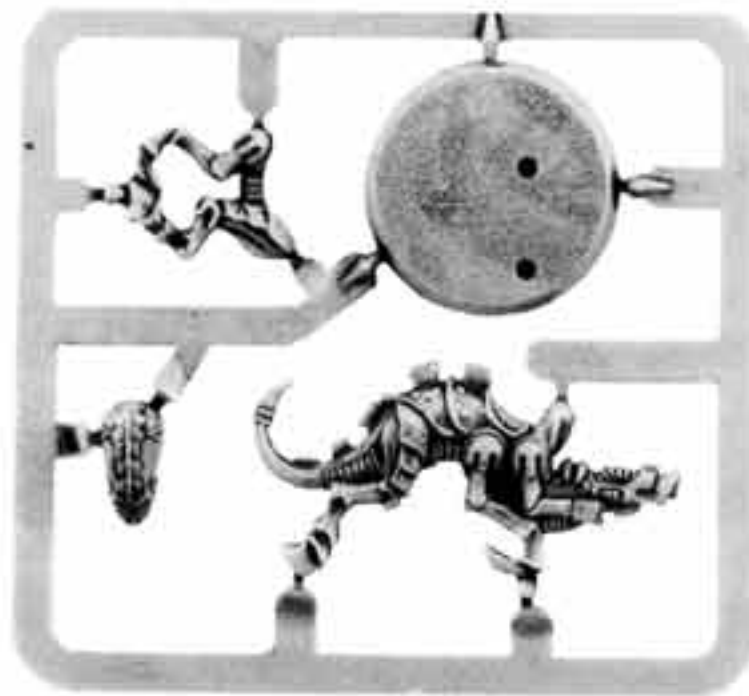

PLASTIC TERMAGANT SPRUE
99389999067

PLASTIC GENESTEALER



GENESTEALER SPRUE
99389999051

THE GENESTEALER MINIATURES ARE AVAILABLE IN TWO DIFFERENT SPRUE VARIANTS, ONE OF WHICH WILL BE SUPPLIED.



TYRANID GENESTEALER



Termagant designed by Michael Perry

Not suitable for children under 8 years due to small parts and essential pointed components. All models supplied unpainted.
© Copyright Games Workshop Ltd. 1998. All rights reserved.

TYRANIDS®

HIVE TYRANT

THE COMPLETE HIVE TYRANT CONSISTS OF:

- 1 x HIVE TYRANT'S BARBED STRANGLER OR VENOM CANNON
- 1 x HIVE TYRANT'S BONESWORD ARM
- 1 x HIVE TYRANT'S LASH WHIP ARM
- 2 x HIVE TYRANT'S SPINE PLATES
- 1 x HIVE TYRANT'S LASH WHIP
- 1 x HIVE TYRANT'S TAIL CLAW
- 1 x HIVE TYRANT'S TAIL
- 1 x HIVE TYRANT'S TORSO
- 1 x HIVE TYRANT'S HEAD
- 1 x HIVE TYRANT'S LEGS



TYRANID HIVE TYRANT



HIVE TYRANT'S HEAD 1
010600201



HIVE TYRANT'S HEAD 2
010600211



HIVE TYRANT'S LASH WHIP
010600208



HIVE TYRANT'S LASH WHIP ARM
010600207



HIVE TYRANT'S TORSO
010600202



HIVE TYRANT'S BONESWORD ARM
010600206



HIVE TYRANT'S TAIL CLAW
010600210



HIVE TYRANT'S TAIL
010600209



HIVE TYRANT'S LEGS
010600204



HIVE TYRANT'S SPINE PLATES
010600203



HIVE TYRANT'S BARBED STRANGLER
010600212

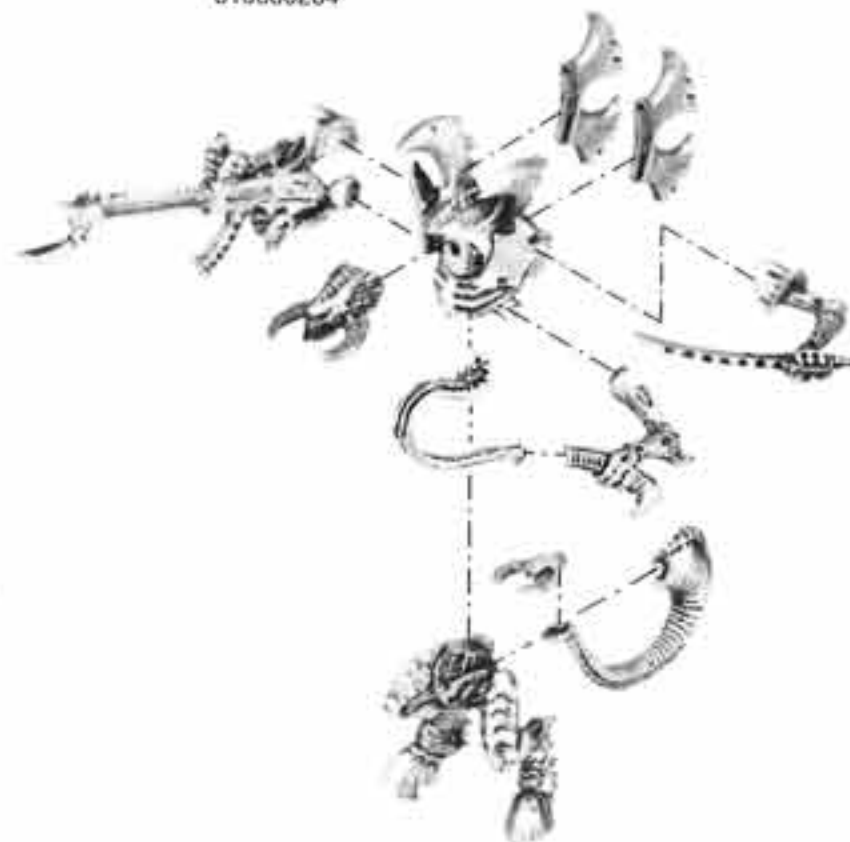

HIVE TYRANT'S VENOM CANON
010600205



TYRANIDS®

LICTOR



TYRANID LICTOR

- THE COMPLETE LICTOR
CONSISTS OF:
- 1 x LICTOR'S UPPER TORSO
 - 1 x LICTOR'S LOWER TORSO
 - 1 x LICTOR'S SPINAL BLADES
 - 1 x LICTOR'S SCYTHE ARM 1
 - 1 x LICTOR'S SCYTHE ARM 2
 - 1 x LICTOR'S HEAD
 - 1 x LICTOR'S LEFT LEG
 - 1 x LICTOR'S RIGHT LEG



LICTOR'S HEAD
010600303



LICTOR'S SPINAL BLADES
010600306



LICTOR'S LEFT LEG
010600308



LICTOR'S RIGHT LEG
010600307



LICTOR'S SCYTHE ARM 1
010600302



LICTOR'S SCYTHE ARM
010600304



LICTOR'S LOWER TORSO
010600305

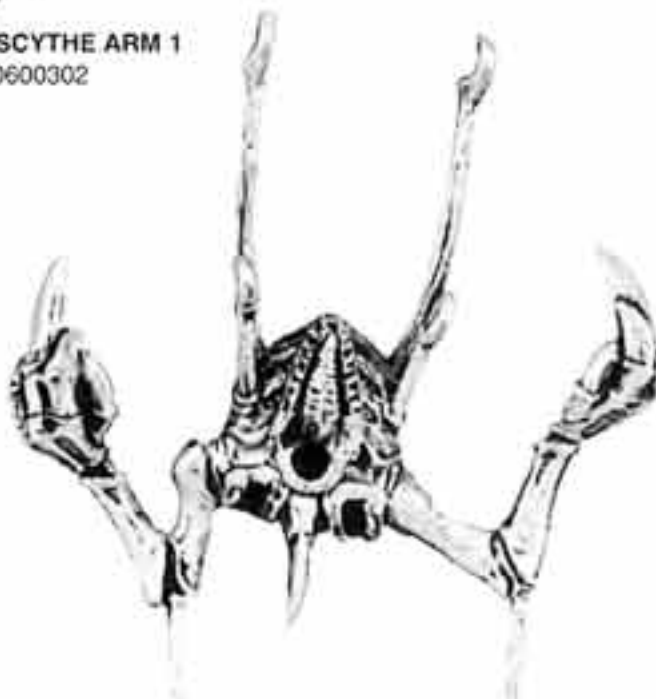

LICTOR'S UPPER TORSO
010600301

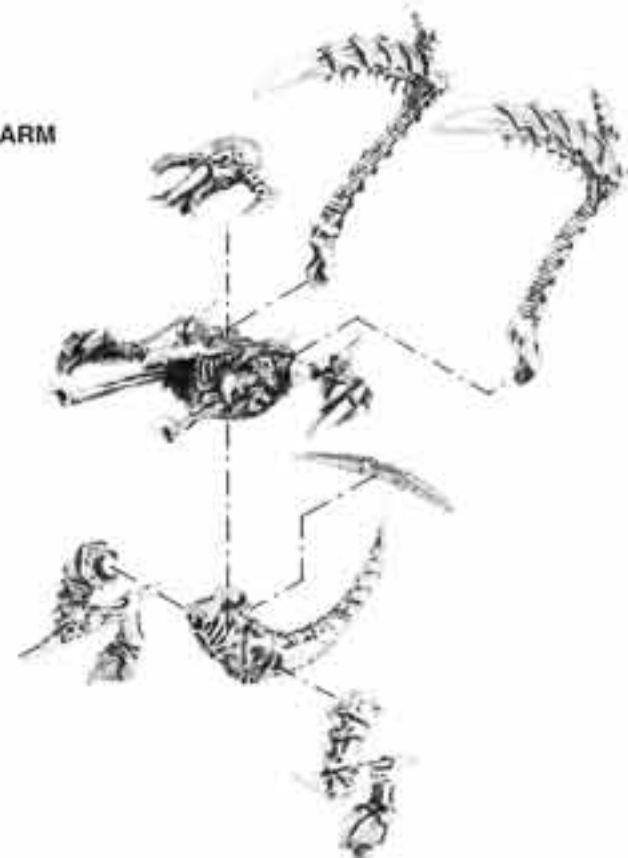

Designed by Micheal Perry

Not suitable for children under 36 months due to small parts and essential pointed components. All models supplied unpainted.
© Copyright Games Workshop Ltd., 1997. All rights reserved.

TYRANIDS®

TYRANID WARRIOR WITH SPINEFIST AND BONESWORD

A COMPLETED
TYRANID WARRIOR WITH SPINEFIST AND BONESWORD
CONSISTS OF:

- 1 x TYRANID WARRIOR HEAD
- 1 x TYRANID WARRIOR BODY
- 1 x TYRANID WARRIOR RIGHT LEG
- 1 x TYRANID WARRIOR LEFT LEG
- 1 x TYRANID WARRIOR RIGHT CLAW
- 1 x TYRANID WARRIOR LEFT CLAW
- 1 x TYRANID WARRIOR RIGHT ARM WITH BONESWORD
- 1 x SPINEFIST ARM



TYRANID WARRIOR WITH SPINEFIST AND BONESWORD



TYRANID WARRIOR WITH DEVOURER

A COMPLETED
TYRANID WARRIOR WITH DEVOURER
CONSISTS OF:

- 1 x TYRANID WARRIOR HEAD
- 1 x TYRANID WARRIOR BODY
- 1 x TYRANID WARRIOR RIGHT LEG
- 1 x TYRANID WARRIOR LEFT LEG
- 1 x TYRANID WARRIOR RIGHT CLAW
- 1 x TYRANID WARRIOR LEFT CLAW
- 1 x TYRANID WARRIOR CANNON ARM
- 1 x DEVOURER ARM

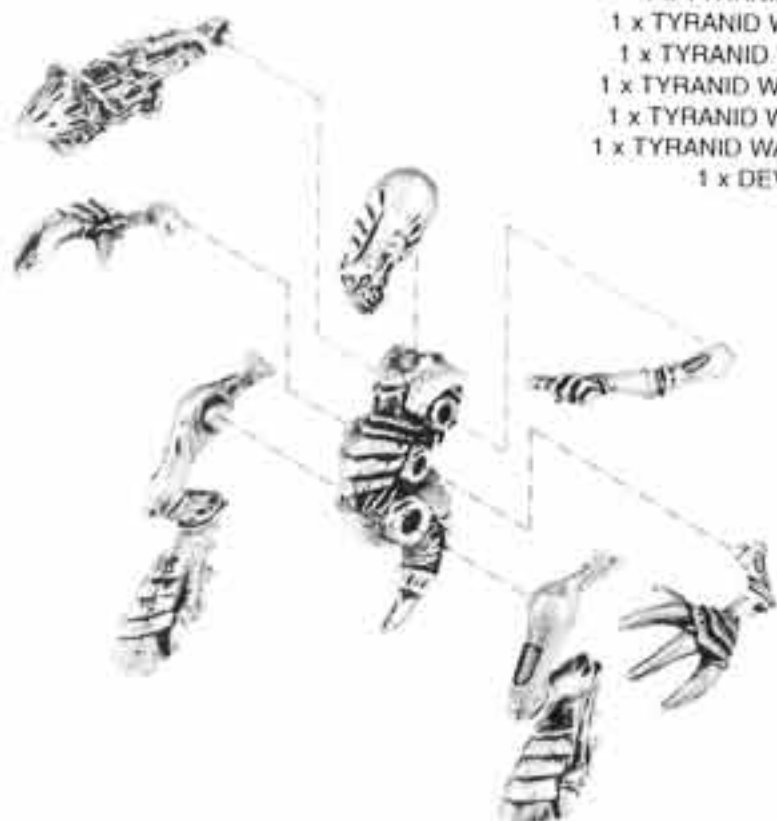

TYRANID WARRIOR WITH DEVOURER

TYRANIDS®

TYRANID WARRIOR WITH BARBED STRANGLER

A COMPLETED
TYRANID WARRIOR WITH BARBED STRANGLER
CONSISTS OF:

- 1 x TYRANID WARRIOR HEAD
- 1 x TYRANID WARRIOR BODY
- 1 x TYRANID WARRIOR RIGHT LEG
- 1 x TYRANID WARRIOR LEFT LEG
- 1 x TYRANID WARRIOR RIGHT CLAW
- 1 x TYRANID WARRIOR LEFT CLAW
- 1 x TYRANID WARRIOR CANNON ARM
- 1 x BARBED STRANGLER ARM

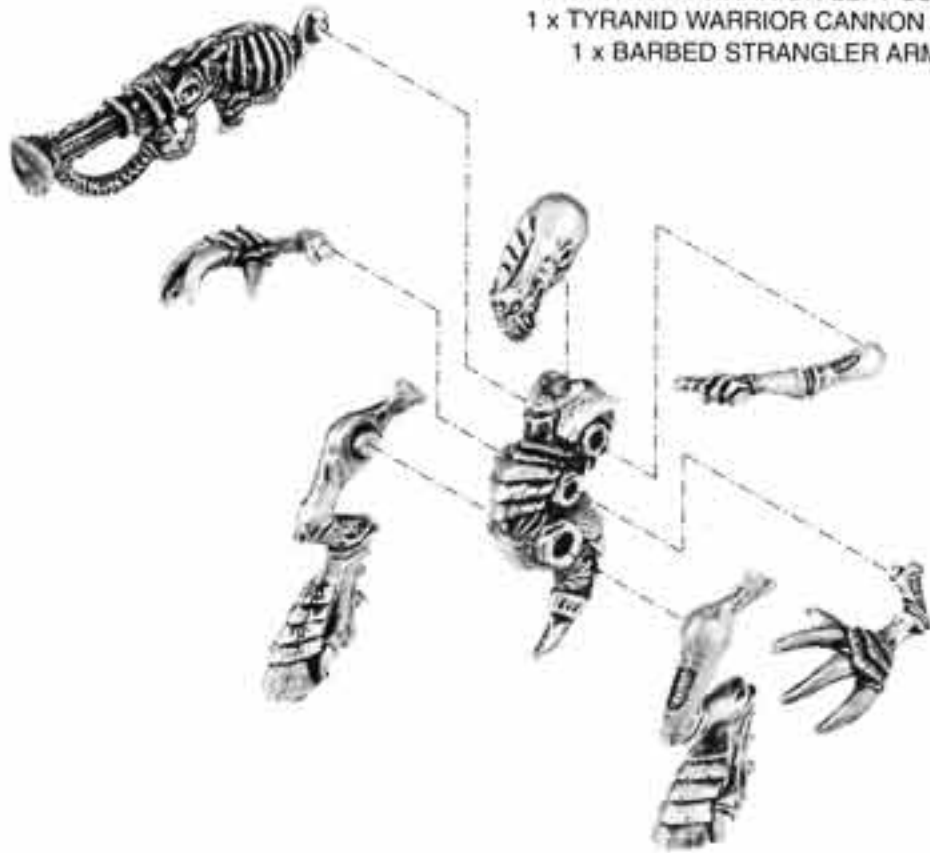

TYRANID WARRIOR
WITH BARBED STRANGLER

TYRANID WARRIOR WITH LASH WHIP AND BONESWORD

A COMPLETED
TYRANID WARRIOR WITH
LASH WHIP AND BONESWORD
CONSISTS OF:

- 1 x TYRANID WARRIOR HEAD
- 1 x TYRANID WARRIOR BODY
- 1 x TYRANID WARRIOR RIGHT LEG
- 1 x TYRANID WARRIOR LEFT LEG
- 1 x TYRANID WARRIOR RIGHT CLAW
- 1 x TYRANID WARRIOR LEFT CLAW
- 1 x TYRANID WARRIOR RIGHT ARM WITH BONESWORD
- 1 x TYRANID WARRIOR WHIP ARM
- 1 x TYRANID WARRIOR LASH WHIP

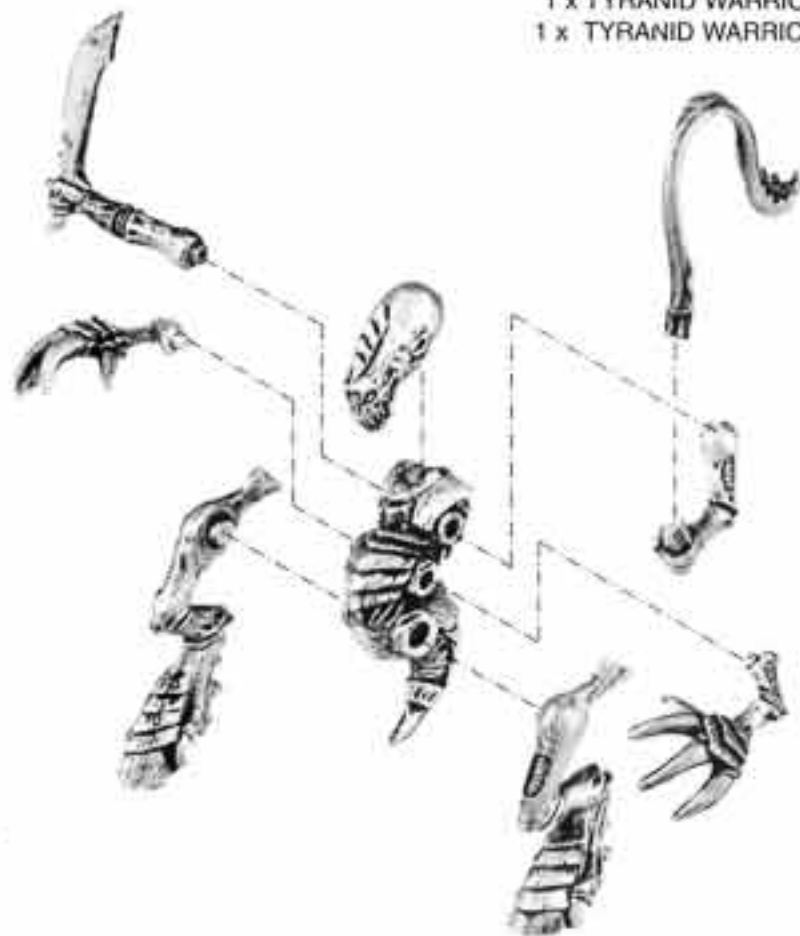

TYRANID WARRIOR WITH LASH WHIP AND
BONESWORD



CITADEL
MINIATURES



CITADEL
MINIATURES

Designed by Alan Perry

Not suitable for children under 36 months due to small parts and essential pointed components. All models supplied unpainted.
© Copyright Games Workshop Ltd., 1997. All rights reserved.

TYRANIDS®

TYRANID WARRIORS



TYRANID WARRIOR
HEAD 1
010600701



TYRANID WARRIOR
HEAD 2
010600716



TYRANID WARRIOR
LEFT CLAW
010600705



TYRANID WARRIOR
RIGHT CLAW
010600706



TYRANID WARRIOR
LASH WHIP
010600208



TYRANID WARRIOR
BODY 1
010600702



TYRANID WARRIOR
BODY 2
010600717

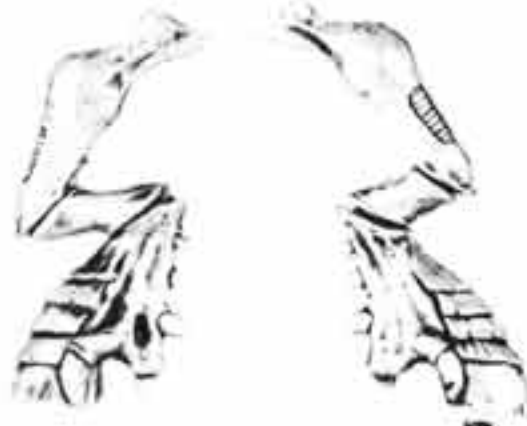

TYRANID WARRIOR
LEFT LEG
010600703



TYRANID WARRIOR
RIGHT LEG
010600704

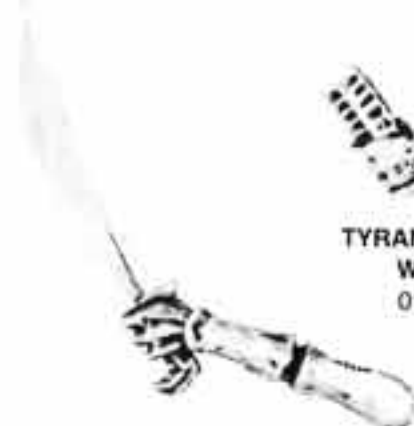

TYRANID WARRIOR
LEFT ARM WITH BONESWORD
010600711



TYRANID WARRIOR
WHIP ARM
010600712



BARBED STRANGLER ARM
010601115



DEVOURER ARM
010600810



TYRANID WARRIOR
RIGHT ARM WITH BONESWORD 1
010600707



VENOM CANNON ARM
010601014



SPINEFIST ARM
010600708



TYRANID WARRIOR
RIGHT ARM WITH BONESWORD 2
010600718



TYRANID WARRIOR
CANNON ARM
010600809

TYRANID WARRIOR WITH VENOM CANNON

A COMPLETED
TYRANID WARRIOR WITH VENOM CANNON
CONSISTS OF:

- 1 x TYRANID WARRIOR HEAD
- 1 x TYRANID WARRIOR BODY
- 1 x TYRANID WARRIOR RIGHT LEG
- 1 x TYRANID WARRIOR LEFT LEG
- 1 x TYRANID WARRIOR RIGHT CLAW
- 1 x TYRANID WARRIOR LEFT CLAW
- 1 x TYRANID WARRIOR CANNON ARM
- 1 x VENOM CANNON ARM

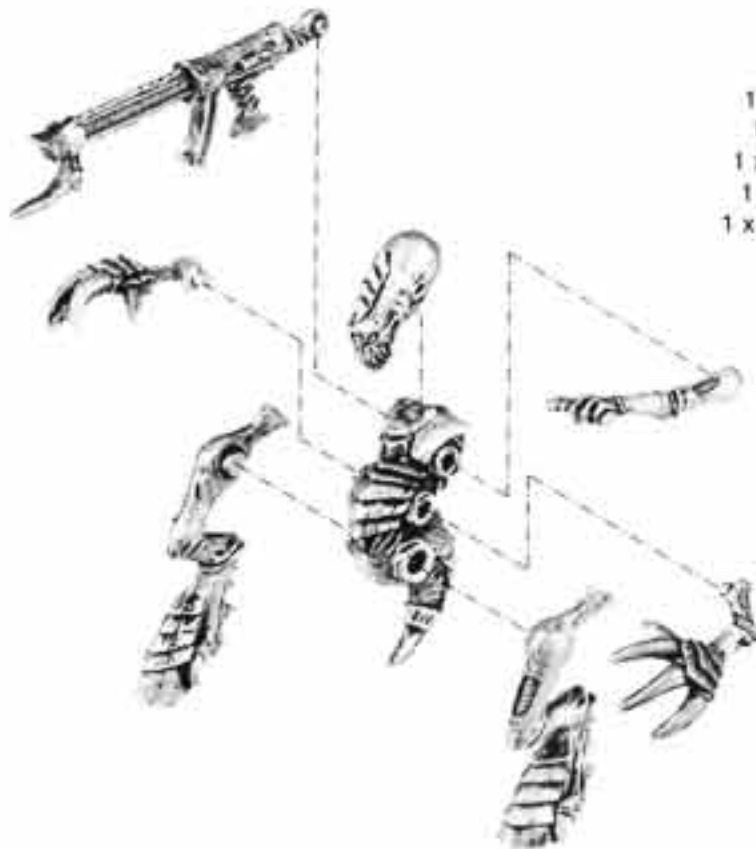

TYRANID WARRIOR WITH VENOM CANNON



TYRANIDS®

HORMAGAUNTS



HORMAGAUNT BODY 1
010600602



HORMAGAUNT BODY 2
010600603



HORMAGAUNT BODY 3
010600601



TYRANID HORMAGAUNT



LEFT FORE ARM
010600605



RIGHT FORE ARM
010600604



REAR CLAWS
010600606

THE COMPLETE HORMAGAUNT
CONSISTS OF:
1 x HORMAGAUNT LEFT FORE ARM
1 x HORMAGAUNT RIGHT FORE ARM
1 x HORMAGAUNT REAR CLAWS
1 x HORMAGAUNT BODY



TERMAGANTS



TERMAGANT 1
010601403



TERMAGANT 2
010601401



TERMAGANT 3
010601402



TERMAGANT 4
010601404



Designed by Michael Perry

Not suitable for children under 8 years due to small parts and essential pointed components. All models supplied unpainted.
© Copyright Games Workshop Ltd. 1998. All rights reserved.

TYRANIDS®

GARGOYLES



TYRANID GARGOYLE



GARGOYLE WINGS
010601601

A COMPLETE GARGOYLE
CONSISTS OF:
1 x GARGOYLE WINGS
1 x GARGOYLE TAIL
1 x GARGOYLE BODY
1 x PLASTIC FLYING BASE



GARGOYLE TAIL 1
010601609



GARGOYLE TAIL 2
010601608



GARGOYLE TAIL 3
010601606



GARGOYLE TAIL 4
010601607



GARGOYLE BODY 1
010601602



GARGOYLE BODY 2
010601604



GARGOYLE BODY 3
010601603



GARGOYLE BODY 4
010601605



BIOVORE AND SPORE MINES

THE COMPLETE BIOVORE
CONSISTS OF:
1 x BODY
1 x FORE ARMS
1 x LEFT LEG
1 x RIGHT LEG



TYRANID BIOVORE



LEFT LEG
010600504



RIGHT LEG
010600503



BODY
010600501



SPORE MINE 1
010600505



SPORE MINE 2
010600506



FORE ARMS
010600502



TYRANIDS®

CARNIFEX

- THE COMPLETE CARNIFEX
CONSISTS OF:
- 1 x CARNIFEX HEAD
 - 1 x CARNIFEX UPPER BODY
 - 1 x CARNIFEX LOWER BODY
 - 1 x CARNIFEX UPPER RIGHT CLAW
 - 1 x CARNIFEX UPPER LEFT CLAW
 - 1 x CARNIFEX LOWER RIGHT CLAW
 - 1 x CARNIFEX LOWER LEFT CLAW
 - 1 x CARNIFEX RIGHT LEG
 - 1 x CARNIFEX LEFT LEG

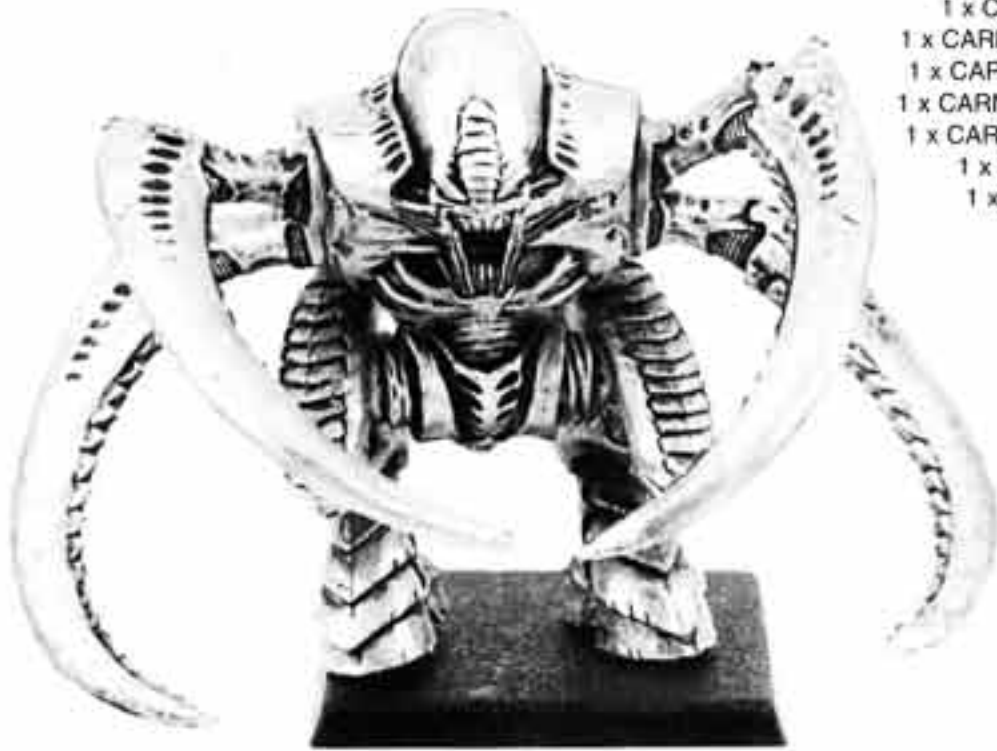

TYRANID CARNIFEX

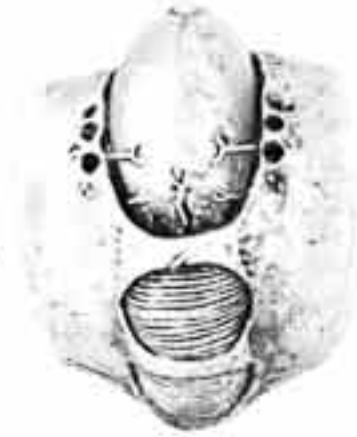

CARNIFEX HEAD
010600101



CARNIFEX UPPER
BODY
010600102



CARNIFEX LOWER RIGHT CLAW
010600108



CARNIFEX UPPER RIGHT CLAW
010600109



CARNIFEX UPPER LEFT CLAW
010600106



CARNIFEX LOWER LEFT CLAW
010600107



CARNIFEX RIGHT LEG
010600105



CARNIFEX LEFT LEG
010600104

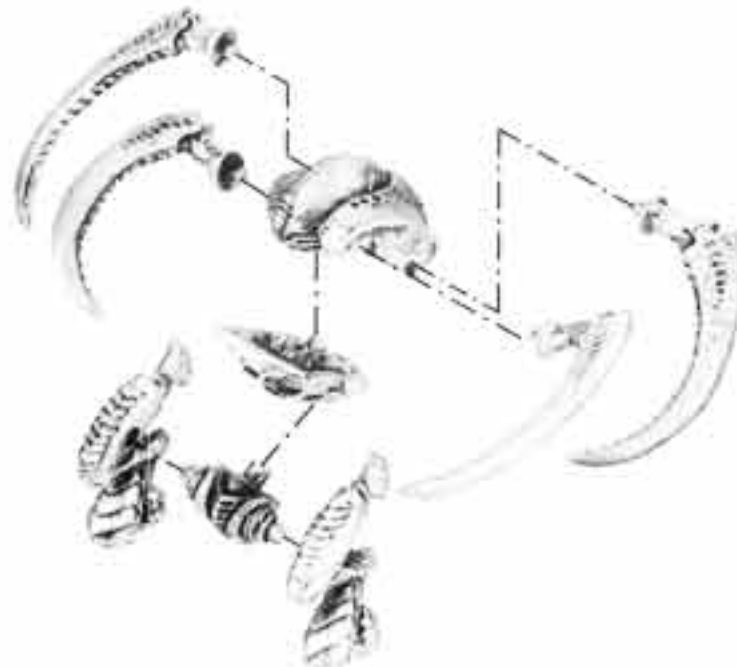

CARNIFEX LOWER BODY
010600103



Designed by Jes Goodwin

Not suitable for children under 36 months due to small parts and essential pointed components. All models supplied unpainted.
© Copyright Games Workshop Ltd., 1997. All rights reserved.

TYRANIDS®

ZOANTHROPE



ZOANTHROPE HEAD
010601301



ZOANTHROPE BODY
010601303



ZOANTHROPE RIGHT ARM
010601309



ZOANTHROPE LEFT ARM
010601308



ZOANTHROPE MANDIBLES
010601302

A COMPLETED ZOANTHROPE
CONSISTS OF:
1 x ZOANTHROPE HEAD
1 x ZOANTHROPE BODY
1 x ZOANTHROPE RIGHT ARM
1 x ZOANTHROPE LEFT ARM
1 x ZOANTHROPE MANDIBLES
1 x ZOANTHROPE RIGHT LEG
1 x ZOANTHROPE LEFT LEG



ZOANTHROPE RIGHT LEG
010601307



ZOANTHROPE LEFT LEG
010601304



TYRANID ZOANTHROPE



RIPPER SWARM



RIPPER SWARM TWIN BODY
010601203



RIPPER SWARM BODY 1



RIPPER SWARM BODY 2

RIPPER SWARM BODY SPRUE
010601202

RIPPER SWARM HEAD
SPRUE
010601201



RIPPER SWARM HEAD 1



RIPPER SWARM HEAD 2



A COMPLETE RIPPER SWARM

A COMPLETE RIPPER SWARM
CONSISTS OF:
1 x RIPPER SWARM TWIN BODY
2 x RIPPER SWARM BODY SPRUE
3x RIPPER SWARM HEAD SPRUE



CITADEL
MINIATURES



CITADEL
MINIATURES

ELDAR®

PLASTIC ELDAR GUARDIAN

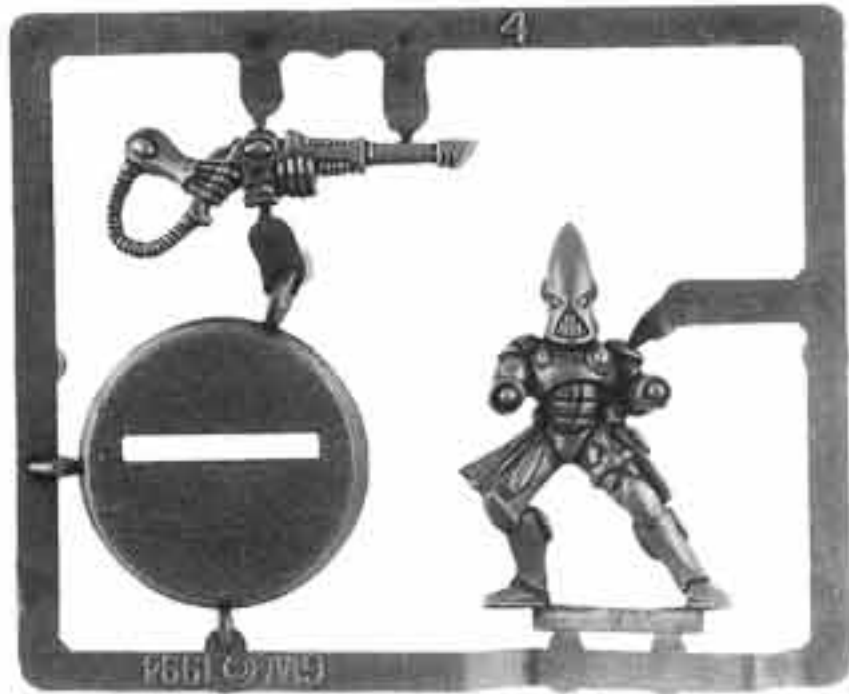

PLASTIC ELDAR GUARDIAN SPRUE
102782



ELDAR GUARDIAN
SHURIKEN CATAPULT
010403901

A COMPLETE ELDAR
GUARDIAN CONSISTS OF:
1 x PLASTIC ELDAR
GUARDIAN SPRUE
1 x ELDAR GUARDIAN
SHURIKEN CATAPULT



PLASTIC ELDAR GUARDIAN
WITH SHURIKEN CATAPULT

Designed by Jes Goodwin



ELDAR®

ELDAR GUARDIANS



ELDAR GUARDIAN 15
010402317



ELDAR GUARDIAN 8
010402318



ELDAR GUARDIAN 6
010402319



ELDAR GUARDIAN 3
010402320



ELDAR GUARDIAN 2
010402321



ELDAR GUARDIAN 13
010402322



ELDAR GUARDIAN 10
010402323



ELDAR GUARDIAN 16
010402324



ELDAR GUARDIAN 7
010402325



ELDAR GUARDIAN 9
010402326

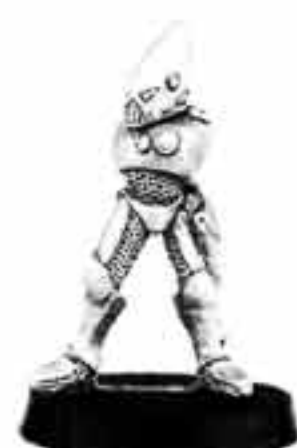

ELDAR GUARDIAN 17
010402327



ELDAR GUARDIAN 11
010402328



ELDAR GUARDIAN 14
010402329



ELDAR GUARDIAN 4
010402330



ELDAR GUARDIAN 18
010402331



ELDAR GUARDIAN 19
010402332



ELDAR GUARDIAN

THESE MODELS ARE SUPPLIED WITH AN ELDAR ARMS SPRUE AND AN ELDAR WEAPONS SPRUE AS STANDARD

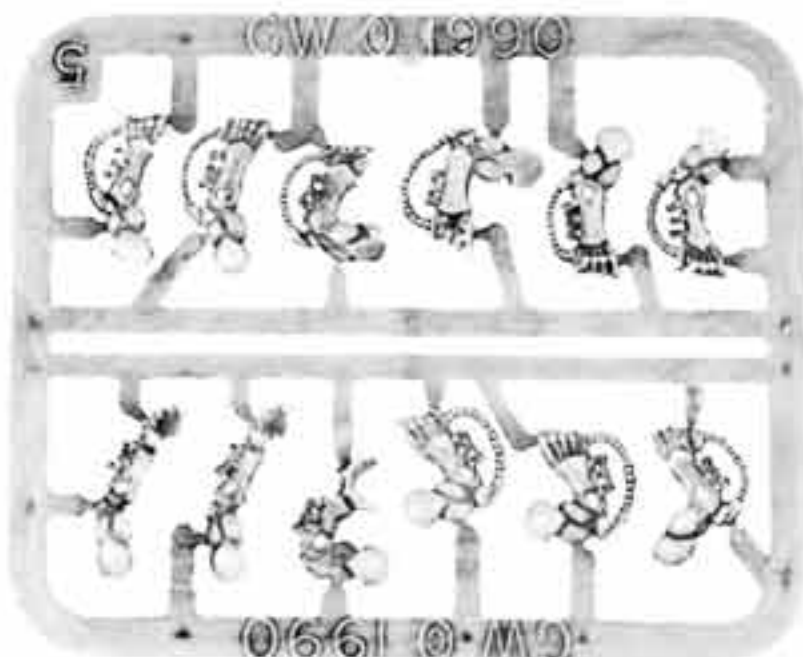

ELDAR ARMS SPRUE
100825



ELDAR WEAPONS SPRUE
100813



CITADEL
MINIATURES



CITADEL
MINIATURES

ELDAR

ELDAR GUARDIAN DEFENDERS



ELDAR GUARDIAN WITH
SHURIKEN CATAPULT 1
010402304



ELDAR GUARDIAN WITH
POWER SWORD AND
SHURIKEN PISTOL 2
010402310



ELDAR GUARDIAN WITH
SHURIKEN CATAPULT 2
010402301



ELDAR GUARDIAN WITH
SHURIKEN CATAPULT 3
010402308



ELDAR GUARDIAN WITH
SHURIKEN CATAPULT 4
010402309



ELDAR GUARDIAN WITH
SHURIKEN CATAPULT AND
SHURIKEN PISTOL
010402306



ELDAR GUARDIAN WITH
POWER SWORD AND
SHURIKEN PISTOL
010402307

ELDAR RANGERS



ELDAR RANGER WITH
SHURIKEN PISTOL AND
RANGER LONG RIFLE 6
010401501



ELDAR RANGER WITH
RANGER LONG RIFLE 1
010401511



ELDAR RANGER WITH POWER
SWORD AND SHURIKEN PISTOL
010401502



ELDAR RANGER WITH
RANGER LONG RIFLE 4
010401512



ELDAR RANGER WITH
RANGER LONG RIFLE 5
010401514



ELDAR RANGER WITH
RANGER LONG RIFLE 2
010401513



ELDAR RANGER WITH
RANGER LONG RIFLE 3
010401516



ELDAR RANGER WITH
RANGER LONG RIFLE 7
071630/3



Designed by Jes Goodwin

Not suitable for children under 8 years due to small parts and essential pointed components. All models supplied unpainted.
© Copyright Games Workshop Ltd. 1998. All rights reserved.

ELDAR®

DARK REAPER ASPECT WARRIORS



DARK REAPER 1
010401607



DARK REAPER 2
010401614



DARK REAPER 3
010401625



MISSILE LAUNCHER
010401608

THE COMPLETE
DARK REAPER
CONSISTS OF:
1 x DARK REAPER
1 x MISSILE
LAUNCHER



DARK REAPER

STRIKING SCORPION ASPECT WARRIORS



STRIKING SCORPION 4
010401121



STRIKING SCORPION 1
010401102



STRIKING SCORPION 2
010401110



STRIKING SCORPION 3
010401116

FIRE DRAGON ASPECT WARRIORS



FIRE DRAGON 1
010401406



FIRE DRAGON 2
010401413



FIRE DRAGON 3
010401419



FIRE DRAGON 4
010401424



ELDAR®

WARP SPIDER ASPECT WARRIORS



WARP SPIDER 1
010402601



WARP SPIDER 2
010402602



WARP SPIDER 3
010402603

SWOOPING HAWK ASPECT WARRIORS



SWOOPING HAWK 1
010401203



SWOOPING HAWK 2
010401211



SWOOPING HAWK 3
010401217



SWOOPING HAWK 4
010401222



SWOOPING HAWK WINGS
010401204

THE COMPLETE SWOOPING HAWK
CONSISTS OF:
1 x SWOOPING HAWK
1 x SWOOPING HAWK WINGS



SWOOPING HAWK

DIRE AVENGER ASPECT WARRIORS



DIRE AVENGER 1
010401305



DIRE AVENGER 2
010401312



DIRE AVENGER 3
010401318



DIRE AVENGER 4
010401323



Designed by Jes Goodwin

Not suitable for children under 36 months due to small parts and essential pointed components. All models supplied unpainted.
© Copyright Games Workshop Ltd., 1997. All rights reserved.

ELDAR®

WRAITHGUARD



WRAITHGUARD HEAD 1
010400801



WRAITHGUARD HEAD 2
010400803



WRAITHGUARD HEAD 3
010400805



WRAITHGUARD BODY 1
010400804



WRAITHGUARD BODY 2
010400802



WRAITHGUARD BODY 3
010400806

A COMPLETE ELDAR WRAITHGUARD
CONSISTS OF:
1 x WRAITHGUARD BODY
1 x WRAITHGUARD HEAD



WRAITHGUARD



CITADEL
MINIATURES



CITADEL
MINIATURES

ELDAR®

ELDRAD ULTHRAN - FARSEER OF ULTHW'E



ELDRAD ULTHRAN
010402701

WARLOCKS



WARLOCK
AND FORCE ROD 1
010402404



WARLOCK
AND SINGING SPEAR
010402407



WARLOCK
AND WITCH BLADE 2
010402401



WARLOCK
AND WITCH BLADE 3
010402406



CITADEL
MINIATURES



CITADEL
MINIATURES

Designed by Jes Goodwin

Not suitable for children under 8 years due to small parts and essential pointed components. All models supplied unpainted.
© Copyright Games Workshop Ltd. 1998. All rights reserved.

ELDAR®

EXARCHS



SWOOPING HAWK EXARCH BODY
010401905



SWOOPING HAWK EXARCH WINGS
010401906



THE COMPLETED SWOOPING HAWK EXARCH CONSISTS OF :
1 x SWOOPING HAWK EXARCH BODY
1 x SWOOPING HAWK EXARCH WINGS



DIRE AVENGER EXARCH
010402007



FIRE DRAGON EXARCH
010402108



STRIKING SCORPION EXARCH
010401804



WARP SPIDER EXARCH BODY
010403001



WARP SPIDER EXARCH CARAPACE
010403002



WARP SPIDER DEATH SPINNERS
010403003

THE COMPLETED WARP SPIDER EXARCH CONSISTS OF
1 x WARP SPIDER EXARCH BODY
1 x WARP SPIDER EXARCH CARAPACE
1 x WARP SPIDER DEATH SPINNERS



WARP SPIDER EXARCH



CITADEL
MINIATURES

ELDAR®

KARANDRAS - THE SHADOW HUNTER



KARANDRAS'S BODY
010402801

THE COMPLETE KARANDRAS
CONSISTS OF:
1 x KARANDRAS'S BODY
1 x KARANDRAS'S HEAD



KARANDRAS'S HEAD
010402802



KARANDRAS

ASURMEN - THE HAND OF ASURYAN



ASURMEN'S BODY
010400401

THE COMPLETED ASURMEN
CONSISTS OF:
1 x ASURMEN'S BODY
1 x ASURMEN'S BANNER POLE



ASURMEN'S BANNER
POLE
010400402



ASURMEN

FUEGAN - THE BURNING LANCE



FUEGAN'S BODY
010402901

THE COMPLETED FUEGAN
CONSISTS OF :
1 x FUEGAN'S BODY
1 x FUEGAN'S FIRE AXE



FUEGAN'S FIRE AXE
010402902



FUEGAN



Designed by Jes Goodwin

ELDAR®

MAUGAN RA – THE HARVESTER OF SOULS



MAUGAN RA'S BODY
010400501



MAUGAN RA'S MAUGETAR
010400502

THE COMPLETED MAUGAN RA
CONSISTS OF:
1 x MAUGAN RA'S BODY
1 x MAUGAN RA'S BACKPACK
1 x MAUGAN RA'S MAUGETAR



MAUGAN RA'S BACKPACK
010400503



MAUGAN RA

JAIN ZAR – THE STORM OF SILENCE



JAIN ZAR'S BODY
010400601



JAIN ZAR'S LEFT ARM
AND BLADE OF DESTRUCTION
010400602

THE COMPLETE JAIN ZAR
CONSISTS OF:
1 x JAIN ZAR'S BODY
1 x JAIN ZAR'S LEFT ARM AND
BLADE OF DESTRUCTION
1 x JAIN ZAR'S RIGHT HAND AND
SILENT DEATH



JAIN ZAR'S RIGHT HAND
AND SILENT DEATH
010400603



JAIN ZAR

BAHARROTH – CRY OF THE WIND



BAHARROTH'S BODY
010400701

THE COMPLETE BAHARROTH
CONSISTS OF:
1 x BAHARROTH'S BODY
1 x BAHARROTH'S WINGS



BAHARROTH'S WINGS
010401906



BAHARROTH



ELDAR®

AVATAR

THE COMPLETED ELDAR AVATAR

CONSISTS OF:

- 1 x AVATAR'S TORSO
- 1 x AVATAR'S LEGS
- 1 x AVATAR'S MANE
- 1 x BLOODY HAND
- 1 x RIGHT ARM AND SWORD



AVATAR

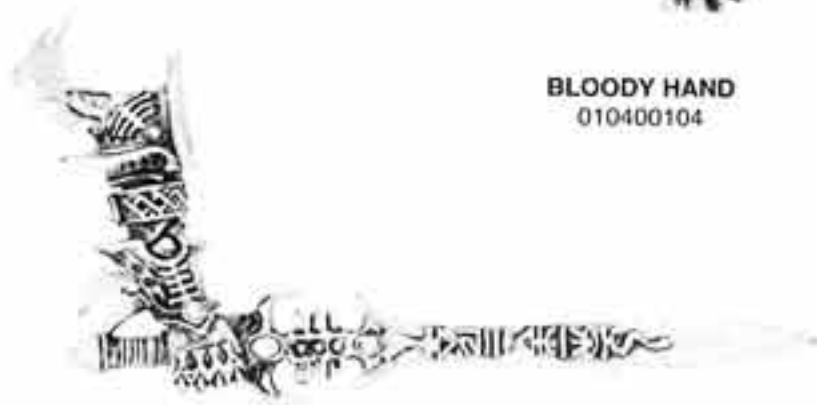

RIGHT ARM AND SWORD
010400103



BLOODY HAND
010400104



AVATAR'S TORSO
010400102



AVATAR'S MANE
010400105



AVATAR'S LEGS
010400101



ELDAR®

GUN CREW



GUNNER WITH SHURIKEN
CATAPULT AND HELMET
010402505



GUNNER WITH
SHURIKEN CATAPULT
010402509



SPOTTER WITH
GOGGLES
010402507



SPOTTER WITH
HELMET
010402508

ANTI-GRAV PLATFORM



LAS CANNON
010402502

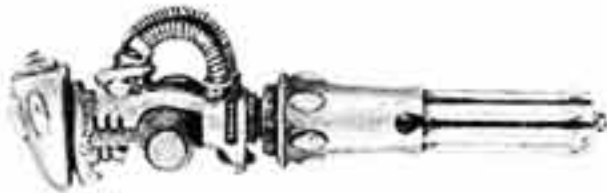

SCATTER LASER
010402501



D - CANNON
010402510



HEAVY PLASMA GUN
010402504

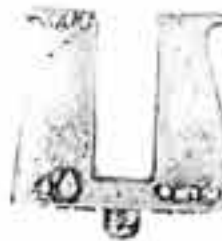

WEAPON SHIELD
010400212



ANTI-GRAV PLATFORM
010402506

THE COMPLETE ELDAR ANTI-GRAV WEAPONS PLATFORM CONSISTS OF:

- 1 x ANTI-GRAV PLATFORM
- 1 x WEAPON SHIELD
- 1 x HEAVY WEAPON
- 1 x GUNNER
- 1 x SPOTTER



ANTI-GRAV PLATFORM WITH
MOUNTED LAS CANNON



ELDAR®

ELDAR WAR WALKER



LAS CANNON
010402502



SCATTER LASER
010402501



ELDAR WAR WALKER LEFT LEG
010400214



ELDAR WAR WALKER RIGHT LEG
010400213



ELDAR WAR WALKER WITH MOUNTED SCATTER LASER AND LAS CANNON



ELDAR WAR WALKER POWER PLANT
010400202

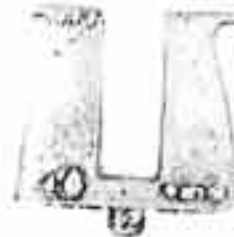

ELDAR WAR WALKER WEAPON SHIELD
010400212



ELDAR WAR WALKER TORSO
010400201



ELDAR WAR WALKER GUARDIAN
010400205

THE COMPLETED ELDAR WAR WALKER CONSISTS OF:
1 x WAR WALKER GUARDIAN
1 x TORSO
1 x POWER PLANT
2 x WEAPON SHIELD
2 x WEAPONS
1 x LEFT LEG
1 x RIGHT LEG

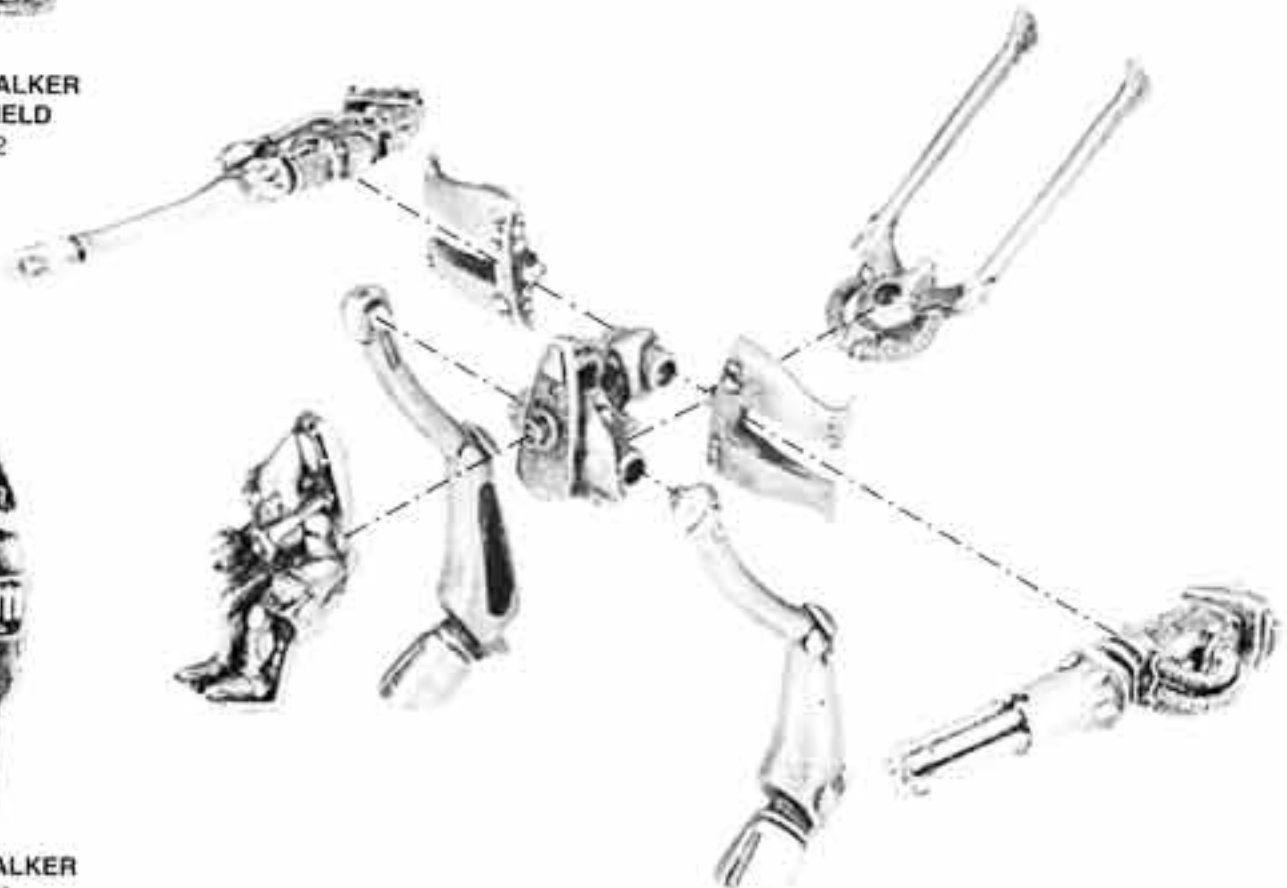

Designed by Jes Goodwin

Not suitable for children under 36 months due to small parts and essential pointed components. All models supplied unpainted.
© Copyright Games Workshop Ltd., 1997. All rights reserved.

ELDAR®

ELDAR WRAITHLORD



SCATTER LASER
010402501



HEAVY PLASMA GUN
010402504



ELDAR WRAITHLORD
LEFT ARM
010400305



ELDAR WRAITHLORD
LEFT LEG
010400308



ELDAR WRAITHLORD
RIGHT LEG
010400307



ELDAR WRAITHLORD
RIGHT ARM
010400304



ELDAR WRAITHLORD WITH
MOUNTED SCATTER LASER



ELDAR WRAITHLORD
POWER PLANT
010400302



ELDAR WRAITHLORD
HEAD
010400303

THE COMPLETED ELDAR
WRAITHLORD CONSISTS OF:
1 x HEAD
1 x POWER PLANT
1 x TORSO
1 x LEFT LEG
1 x RIGHT LEG
1 x RIGHT ARM
1 x WEAPON



ELDAR WRAITHLORD
TORSO
010400201

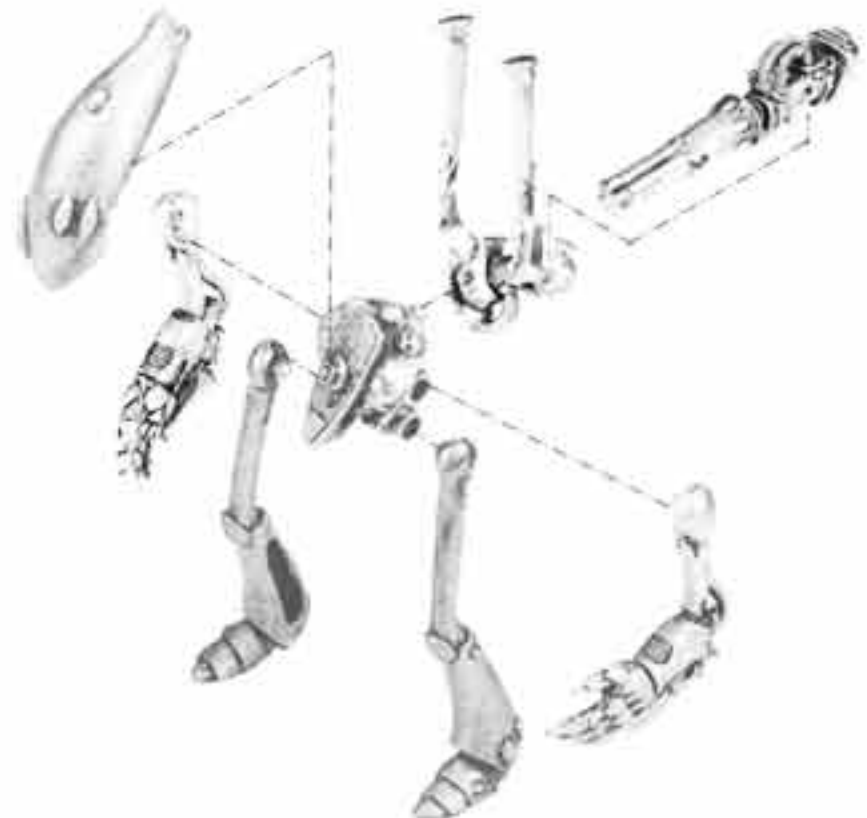

CITADEL
MINIATURES



CITADEL
MINIATURES

ELDAR®

ELDAR SHRIEKER JETBIKE

A COMPLETE ELDAR SHRIEKER JETBIKE CONSISTS OF:
1 x PLASTIC ELDAR JETBIKE SPRUE
1 x METAL SHRIEKER CANNON
1 x METAL JETBIKE RIDER TORSO
1 x PLASTIC FLYING BASE
1 x PLASTIC ELDAR WEAPON SPRUE



SHRIEKER CANNON
010403102



JETBIKE RIDER TORSO
010403101

ELDAR JETBIKE

A COMPLETE ELDAR JETBIKE CONSISTS OF:
1 x PLASTIC ELDAR JETBIKE SPRUE
1 x PLASTIC FLYING BASE
1 x PLASTIC ELDAR WEAPON SPRUE



THESE MODEL KITS INCLUDE A CITADEL TRANSFER SHEET AND FULL COLOUR ADHESIVE BANNERS. THE TRANSFER SHEET INCLUDES ENOUGH MARKINGS FOR SEVERAL DIFFERENT CRAFTWORLDS.

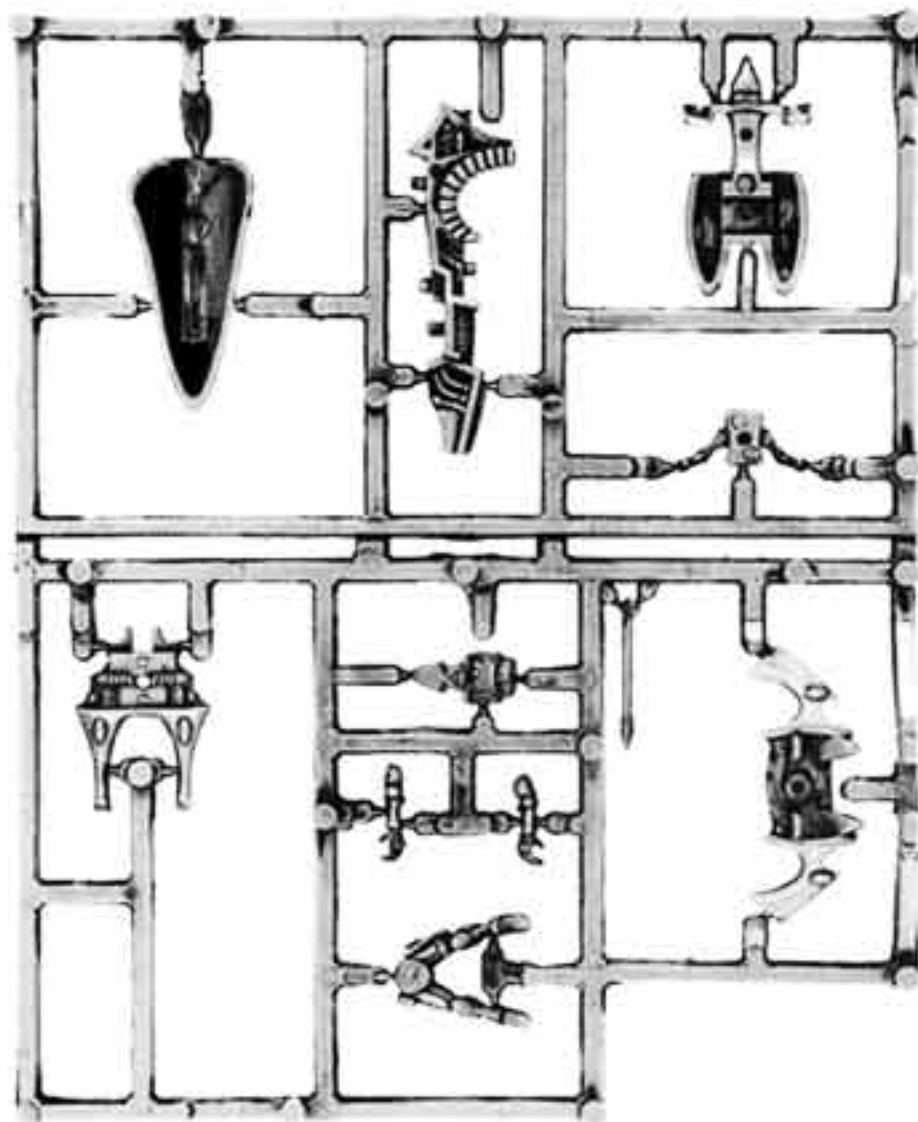

ELDAR JETBIKE SPRUE 102784 (SHOWN AT 50% OF ACTUAL SIZE)

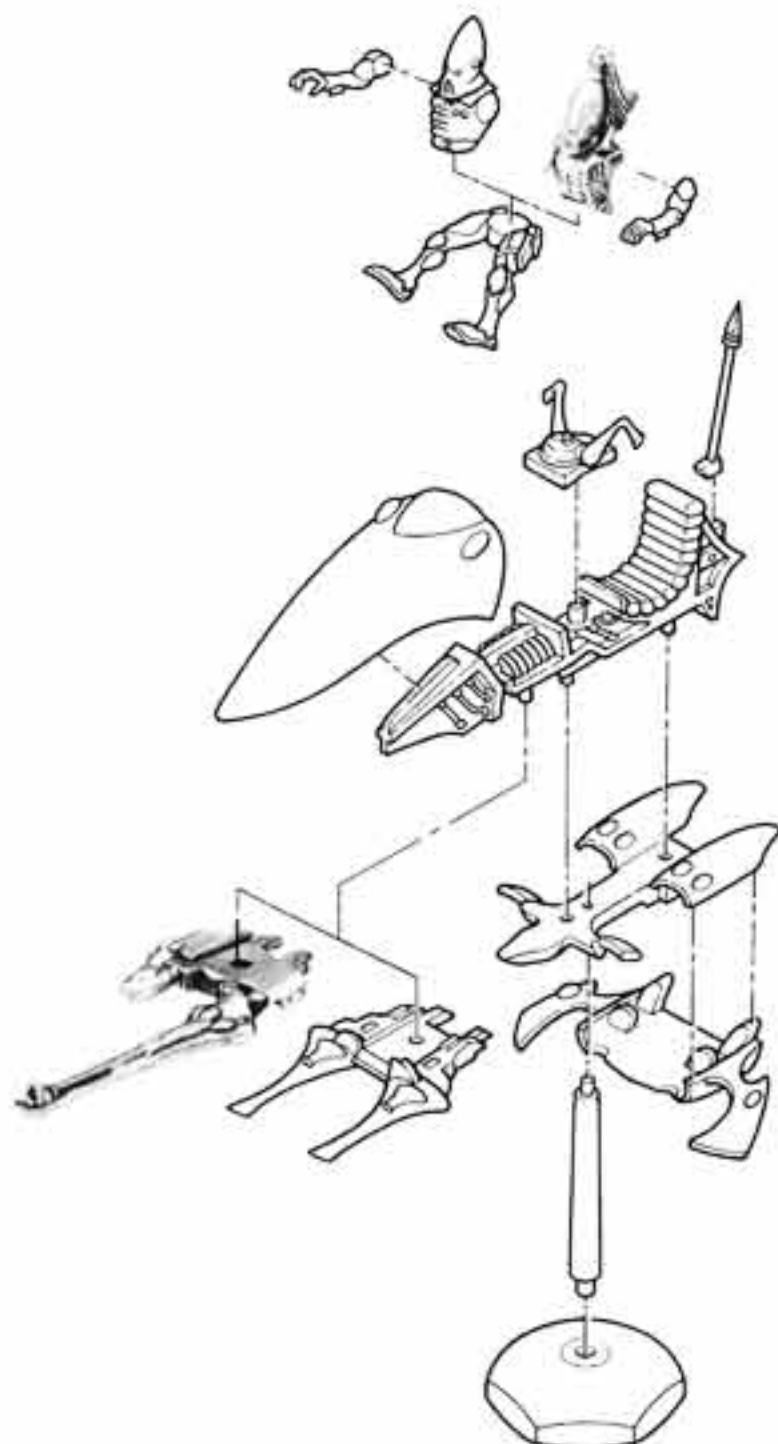

THE PLASTIC PARTS NEED TO BE ASSEMBLED USING POLYSTYRENE CEMENT.

Designed by Jes Goodwin

Not suitable for children under 36 months due to small parts and essential pointed components. All models supplied unpainted.
© Copyright Games Workshop Ltd., 1997. All rights reserved.

ELDAR®

VYPER JETBIKE

A COMPLETED VYPER JETBIKE
CONSISTS OF:
1 X VYPER SPRUE
1 X CANOPY
1 X TRANSFER SHEET

NOTE: ALL ELDAR HEAVY
WEAPONS WILL ALSO FIT THE
ELDAR VYPER JETBIKE



ELDAR VYPER CANOPY
102824

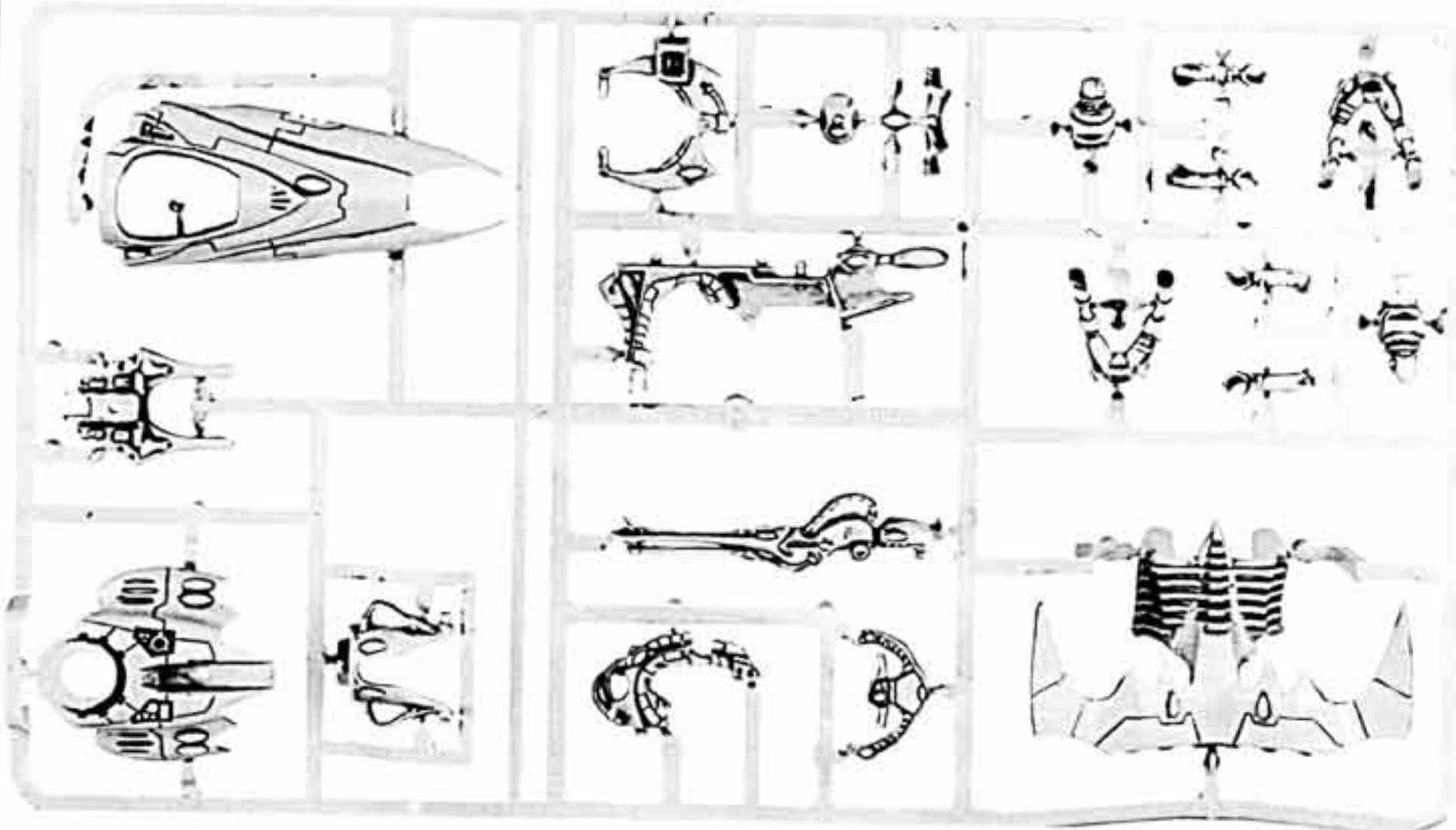

ELDAR VYPER JETBIKE SPRUE (SHOWN AT 50% OF ACTUAL SIZE)
102823



ELDAR

FIRE PRISM GRAV TANK

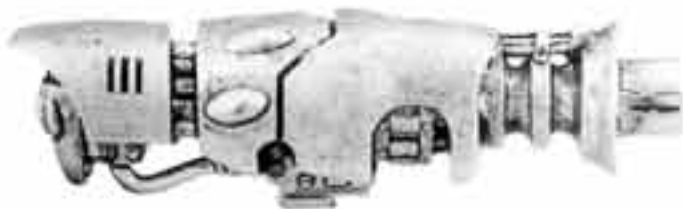

FIRE PRISM ENERGISER
010403801



FIRE PRISM PROBE
010403802



FIRE PRISM SENSOR
010403803



FIRE PRISM CRYSTAL SIDE B
010403805



FIRE PRISM GENERATOR
010403806

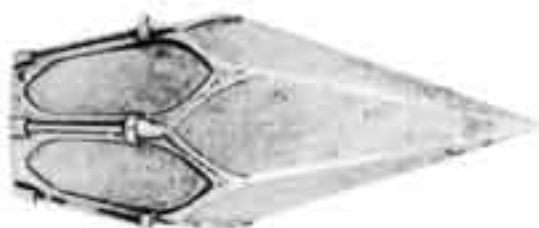

FIRE PRISM CRYSTAL SIDE A
010403804



FIRE PRISM LASER PROJECTOR
010403807

THE FIRE PRISM GRAV TANK CONSISTS OF:

- 1 x FALCON GRAV TANK TOP HULL SPRUE
- 1 x FALCON GRAV TANKS TOP HULL SPRUE
- 1 x FALCON GRAV TANK TURRET SPRUE
- 2 x CANOPY
- 1 x FALCON GRAV TANK TRANSFER SHEET
- 1 x FIRE PRISM ENERGISER
- 1 x FIRE PRISM PROBE
- 1 x FIRE PRISM SENSOR POD
- 1 x FIRE PRISM SIDE A
- 1 x FIRE PRISM SIDE B
- 1 x FIRE PRISM GENERATOR
- 1 x FIRE PRISM LASER PROJECTOR

Falcon Grav Tank designed by Jes Goodwin, Fire Prism designed by Tim Adcock

Not recommended for children under 8 years due to small parts and essential pointed components. All models supplied unpainted.
© Copyright Games Workshop Ltd. 1998. All rights reserved.

ELDAR

FALCON GRAV TANK



- A COMPLETE FALCON GRAV TANK CONSISTS OF:**
- 1 x FALCON GRAV TANK TOP HULL SPRUE
 - 1 x FALCON GRAV TANK BOTTOM HULL SPRUE
 - 1 x FALCON GRAV TANK TURRET SPRUE
 - 1 x VYPER CANOPY
 - 1 x FALCON GRAV TANK TRANSFER SHEET

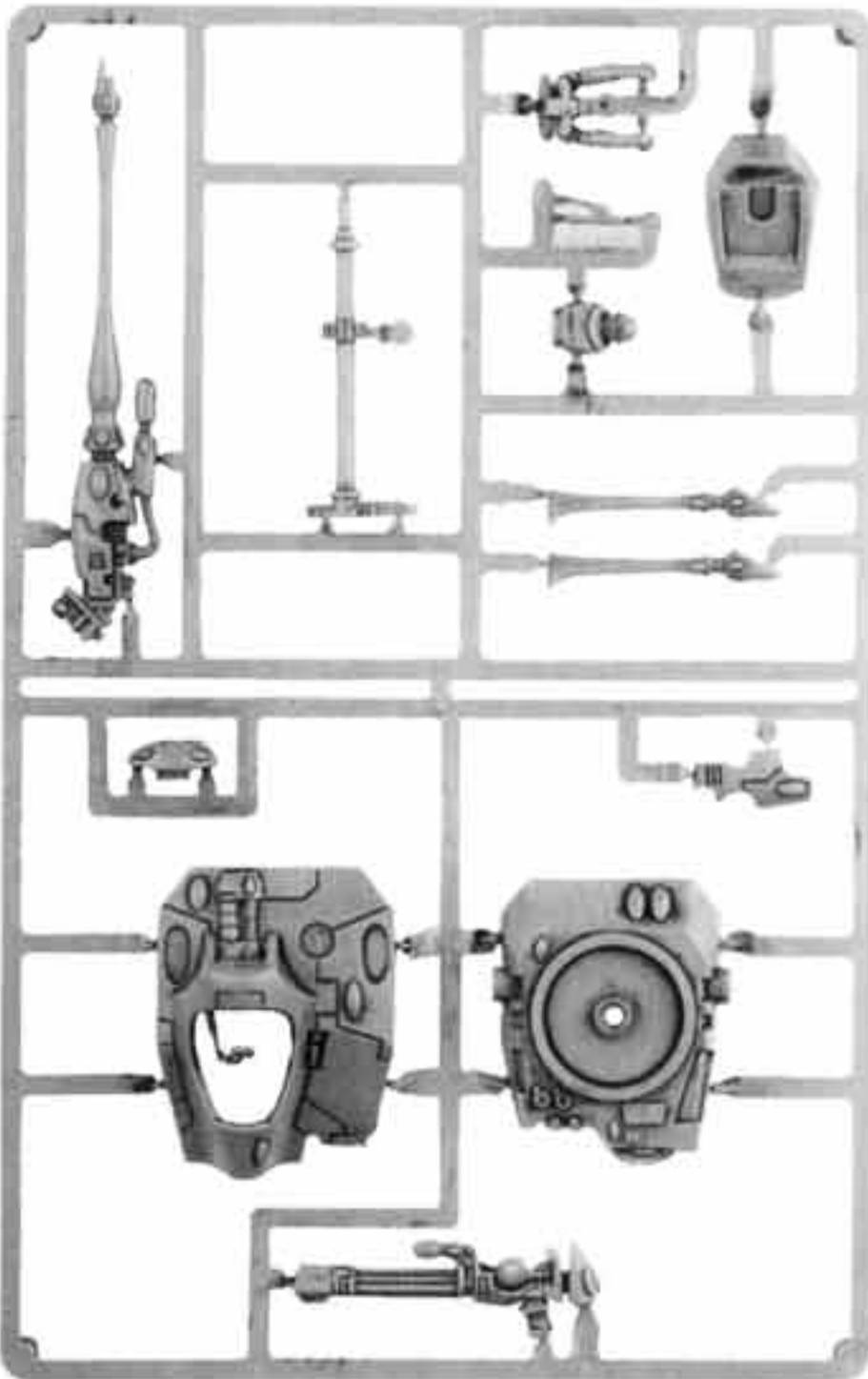

FALCON GRAV TANK TURRET SPRUE
99390104002 (SHOWN AT 55% OF ACTUAL SIZE)



FALCON GRAV TANK TRANSFER SHEET
390104002 (SHOWN AT 75% OF ACTUAL SIZE)



ELDAR®

FALCON GRAV TANK

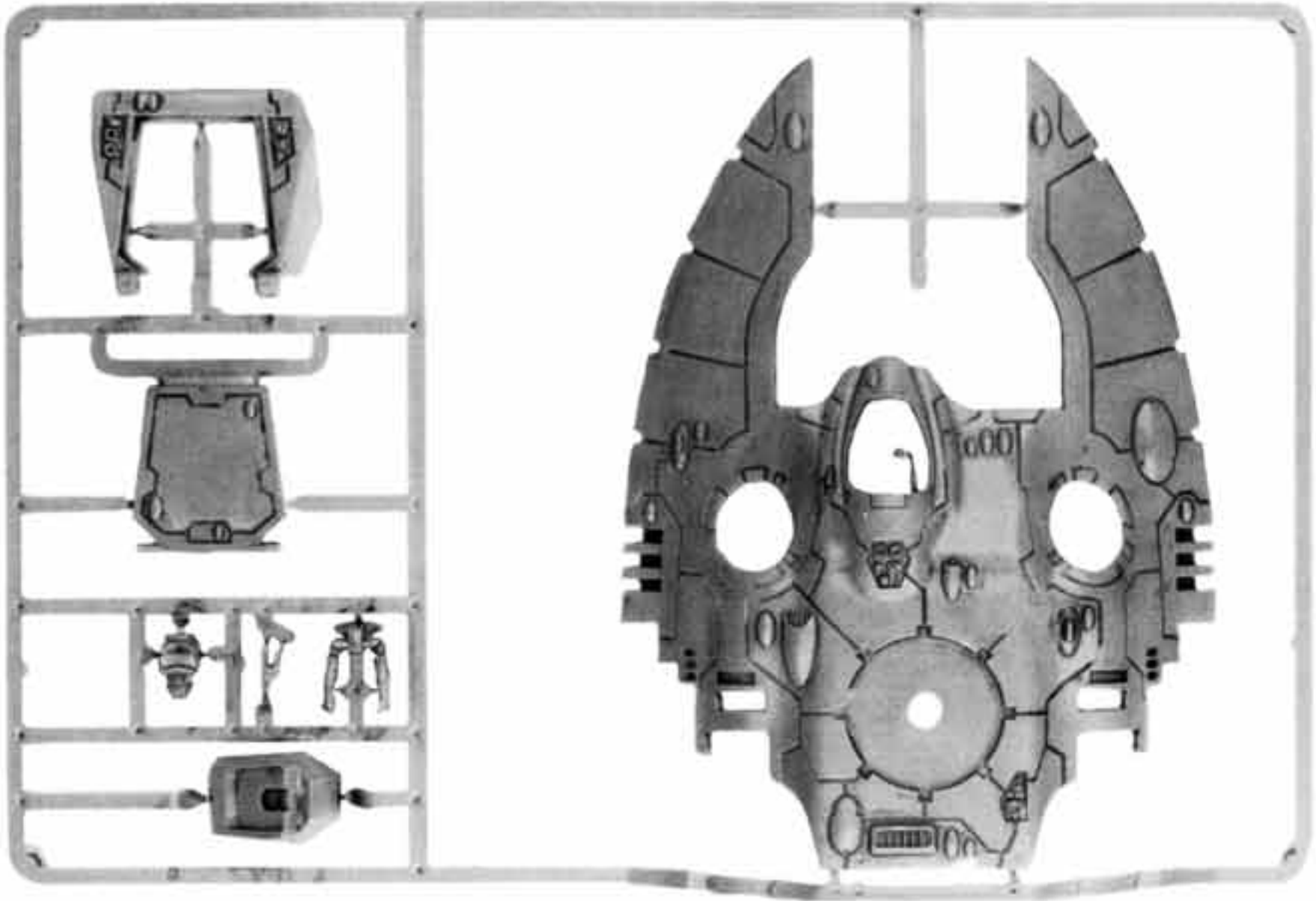

FALCON GRAV TANK TOP HULL SPRUE
99390104001 (SHOWN AT 60% OF ACTUAL SIZE)

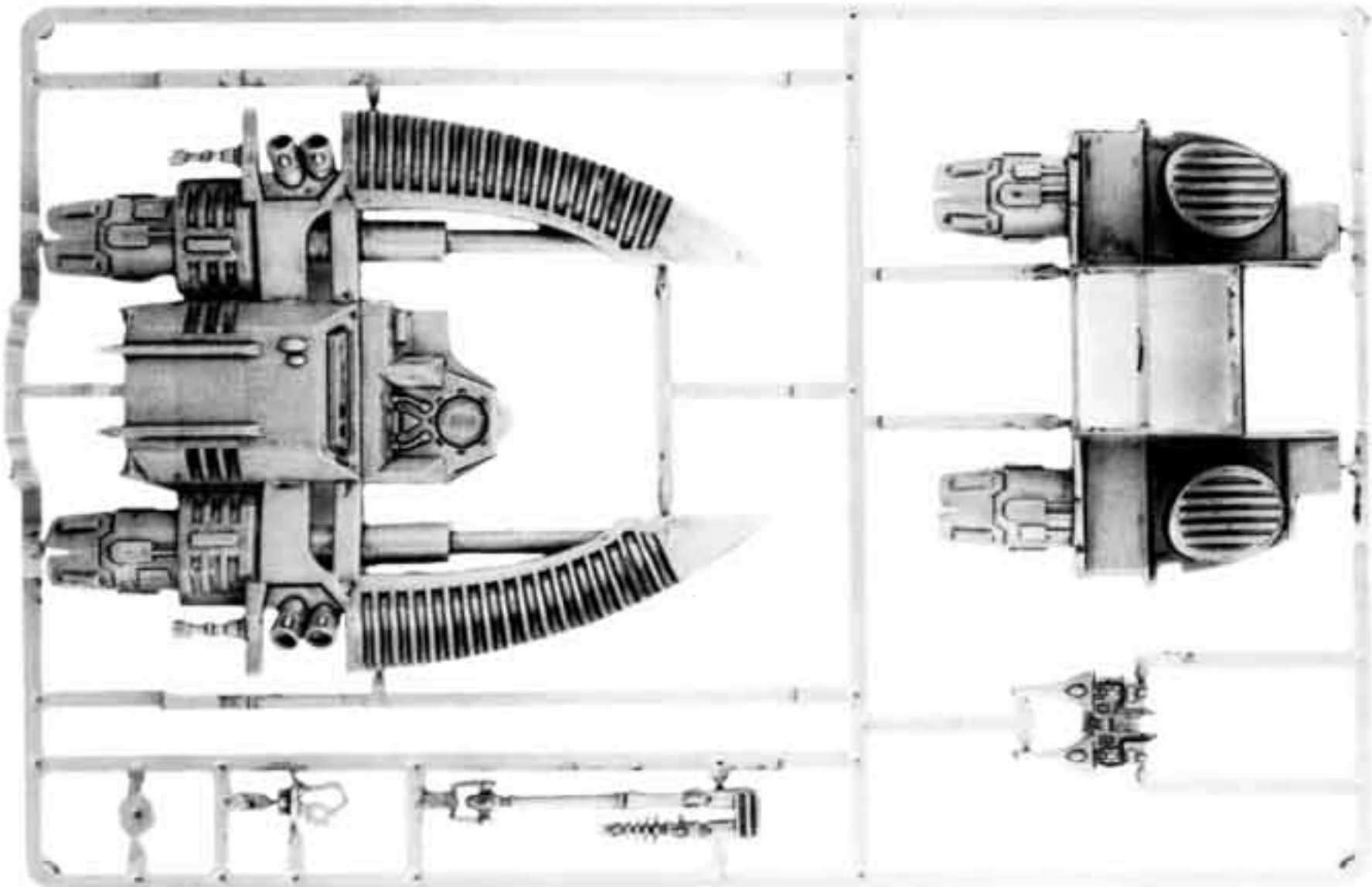

FALCON GRAV TANK BOTTOM HULL SPRUE
99390104003 (SHOWN AT 60% OF ACTUAL SIZE)



Designed by Jes Goodwin

Not suitable for children under 36 months due to small parts and essential pointed components. All models supplied unpainted.
© Copyright Games Workshop Ltd., 1997. All rights reserved.

CHAOS SPACE MARINES®

NURGLE PLAGUE MARINES



NURGLE PLAGUE MARINE

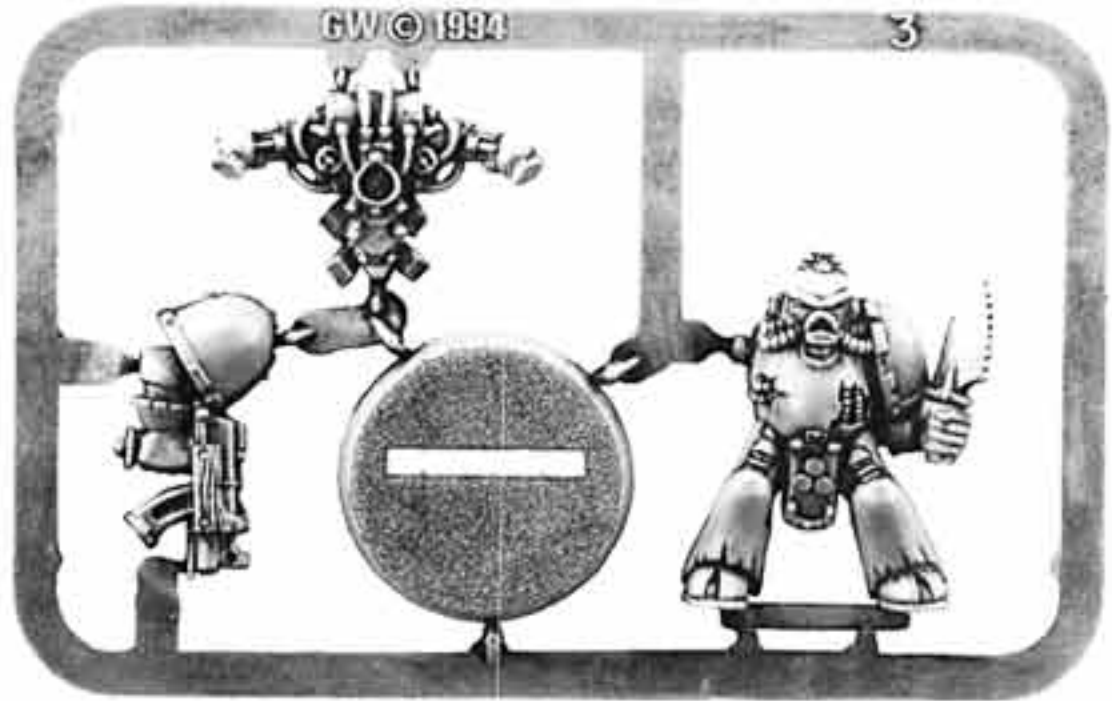

NURGLE PLAGUE MARINE SPRUE
99389999023

PLASTIC CHAOS SPACE MARINES



PLASTIC CHAOS SPACE MARINES

A COMPLETE PLASTIC CHAOS SPACE MARINE CONSISTS OF:
1X PLASTIC CHAOS SPACE MARINE SPRUE
1X CHAOS SPACE MARINE BACKPACK SPRUE
1X CHAOS SPACE MARINE ARMS SPRUE



PLASTIC CHAOS SPACE MARINE SPRUE
99399999009

CHAOS SPACE MARINE SPRUES



CHAOS SPACE MARINE
CLOSE COMBAT WEAPON SPRUE 1
99399999005



CHAOS SPACE MARINE
CLOSE COMBAT WEAPON SPRUE 2
99399999005



CHAOS SPACE MARINE BACKPACK SPRUE
99399999004



CHAOS SPACE MARINES®

CHAOS SPACE MARINES



CHAOS SPACE MARINE CHAMPION 1
010202701



CHAOS SPACE MARINE CHAMPION 2
010200403



CHAOS SPACE MARINE WITH MK1 PLASMA GUN
010202802



CHAOS SPACE MARINE WITH FLAMER
010200401



CHAOS SPACE MARINE 1
010202903



CHAOS SPACE MARINE 2
010202904



CHAOS SPACE MARINE 3
010202905



CHAOS SPACE MARINE 4
010202906



CHAOS SPACE MARINE 5
010202907



CHAOS SPACE MARINE 6
010202908



CHAOS SPACE MARINE 7
010200402

A COMPLETED CHAOS SPACE MARINE CONSISTS OF:
1 x CHAOS SPACE MARINE
1 x CHAOS SPACE MARINE ARM SPRUE
1 x CHAOS SPACE MARINE BACKPACK SPRUE



CHAOS SPACE MARINE



CHAOS SPACE MARINE ARM SPRUE 1
102805

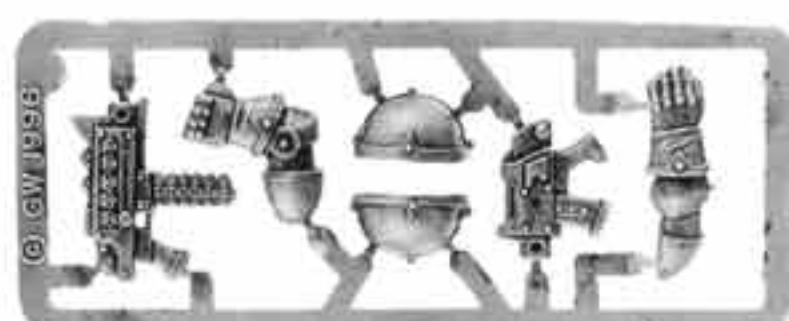

CHAOS SPACE MARINE ARM SPRUE 2
102805



Designed by Aly Morrison

Not suitable for children under 36 months due to small parts and essential pointed components. All models supplied unpainted.
© Copyright Games Workshop Ltd., 1997. All rights reserved.

CHAOS SPACE MARINES®

CHAOS SPACE MARINE HAVOCS

A COMPLETED CHAOS SPACE MARINE HAVOC WITH HEAVY BOLTER CONSISTS OF:

- 1 x CHAOS SPACE MARINE HAVOC HEAVY BOLTER BODY
- 1 x HEAVY BOLTER
- 1 x HEAVY BOLTER BACKPACK
- 1 x HEAVY BOLTER ARM



CHAOS SPACE MARINE HAVOC HEAVY BOLTER BODY
010201201



HEAVY BOLTER BACKPACK
010201204



HEAVY BOLTER ARM
010201203



HEAVY BOLTER
010201202



CHAOS SPACE MARINE HAVOC WITH HEAVY BOLTER

A COMPLETED CHAOS SPACE MARINE HAVOC WITH MISSILE LAUNCHER CONSISTS OF:

- 1 x CHAOS SPACE MARINE HAVOC MISSILE LAUNCHER BODY
- 1 x MISSILE LAUNCHER
- 1 x MISSILE LAUNCHER BACKPACK
- 1 x CHAOS SPACE MARINE ARM SPRUE



CHAOS SPACE MARINE HAVOC MISSILE LAUNCHER BODY
010200408



MISSILE LAUNCHER BACKPACK
010200410



MISSILE LAUNCHER
010200409



CHAOS SPACE MARINE HAVOC WITH MISSILE LAUNCHER

A COMPLETED CHAOS SPACE MARINE HAVOC WITH AUTOCANNON CONSISTS OF:

- 1 x CHAOS SPACE MARINE HAVOC AUTOCANNON BODY
- 1 x AUTOCANNON
- 1 x AUTOCANNON BACKPACK
- 1 x AUTOCANNON ARM



CHAOS SPACE MARINE HAVOC AUTOCANNON BODY
010201209



AUTOCANNON BACKPACK
010201212



AUTOCANNON ARM
010201211

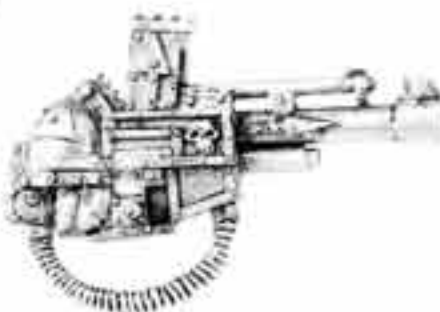

AUTOCANNON
010201210



CHAOS SPACE MARINE HAVOC WITH AUTOCANNON

A COMPLETED CHAOS SPACE MARINE HAVOC WITH LASCANNON CONSISTS OF:

- 1 x CHAOS SPACE MARINE HAVOC LASCANNON BODY
- 1 x LASCANNON
- 1 x LASCANNON BACKPACK
- 1 x LASCANNON ARM



CHAOS SPACE MARINE HAVOC LASCANNON BODY
010201205



LASCANNON BACKPACK
010201208



LASCANNON ARM
010201207



LASCANNON
010201206



CHAOS SPACE MARINE HAVOC WITH LASCANNON



Designed by Aly Morrison

CHAOS SPACE MARINES®

CHAOS SPACE MARINE VETERANS SHOULDER PADS

THIS RANGE OF SHOULDER PADS PROVIDES THE OPPORTUNITY TO CUSTOMISE INDIVIDUAL MODELS OR ENTIRE SQUADS OF CHAOS SPACE MARINE VETERANS. THERE ARE SPECIFIC DESIGNS FOR THE MAJOR CHAOS LEGIONS AS WELL AS LOTS OF NON-SPECIFIC LEGION DESIGNS THAT CAN BE USED ON JUST ABOUT ANY CHAOS SPACE MARINE MODEL.



EMPEROR'S CHILDREN
CHAOS SPACE MARINE
SHOULDER PAD
010202007



DEATH GUARD
CHAOS SPACE MARINE
SHOULDER PAD
010202020



WORLD EATERS
CHAOS SPACE MARINE
SHOULDER PAD
010202017



THOUSAND SONS
CHAOS SPACE MARINE
SHOULDER PAD
010202016



NIGHT LORDS
CHAOS SPACE MARINE
SHOULDER PAD
010202021



ALPHA LEGION
CHAOS SPACE MARINE
SHOULDER PAD
010202008



IRON WARRIORS
CHAOS SPACE MARINE
SHOULDER PAD
010202009



BLACK LEGION
CHAOS SPACE MARINE
SHOULDER PAD
010202027



WORD BEARERS
CHAOS SPACE MARINE
SHOULDER PAD
010202022



CHAOS SPACE MARINE
SHOULDER PAD 17
010202029



CHAOS SPACE MARINE
SHOULDER PAD 3
010202026



CHAOS SPACE MARINE
SHOULDER PAD 4
010202014



CHAOS SPACE MARINE
SHOULDER PAD 5
010202004



CHAOS SPACE MARINE
SHOULDER PAD 6
010202003



CHAOS SPACE MARINE
SHOULDER PAD 7
010202002



CHAOS SPACE MARINE
SHOULDER PAD 8
010202001



CHAOS SPACE MARINE
SHOULDER PAD 9
010202015



CHAOS SPACE MARINE
SHOULDER PAD 10
010202018



CHAOS SPACE MARINE
SHOULDER PAD 11
010202010



CHAOS SPACE MARINE
SHOULDER PAD 12
010202006



CHAOS SPACE MARINE
SHOULDER PAD 13
010202013



CHAOS SPACE MARINE
SHOULDER PAD 14
010202023



CHAOS SPACE MARINE
SHOULDER PAD 15
010202024



CHAOS SPACE MARINE
SHOULDER PAD 16
010202025



CHAOS SPACE MARINES VETERANS ASSEMBLED USING JUST A FEW OF THE CHAOS SPACE MARINE VETERAN SHOULDER PADS



CITADEL
MINIATURES



CITADEL
MINIATURES

Designed by Aly Morrison

Not suitable for children under 8 years due to small parts and essential pointed components. All models supplied unpainted.
© Copyright Games Workshop Ltd. 1998. All rights reserved.

CHAOS SPACE MARINES

PLAGUE MARINES



PLAGUE MARINE CHAMPION 1
010200801



PLAGUE MARINE CHAMPION 2
010200802



PLAGUE MARINE CHAMPION 3
010200803



PLAGUE MARINE WITH
MELTA-GUN
010200701



PLAGUE MARINE WITH
PLASMA GUN
010200702



PLAGUE MARINE 1
010203001



PLAGUE MARINE 2
010203002



PLAGUE MARINE 3
010203003



**A COMPLETE PLAGUE
MARINE CONSISTS OF:**
1 x PLAGUE MARINE
1 x CHAOS SPACE MARINE ARM SPRUE
1 x CHAOS SPACE MARINE BACKPACK SPRUE

**A COMPLETE PLAGUE
MARINE CHAMPION CONSISTS OF:**
1 x PLAGUE MARINE CHAMPION
1 x CHAOS SPACE MARINE ARM SPRUE
1 x CHAOS SPACE MARINE BACKPACK SPRUE

PLAGUE MARINES



CHAOS SPACE MARINES®

NOISE MARINES



NOISE MARINE
BODY 1
010202310



NOISE MARINE
BODY 2
010202206



NOISE MARINE
BODY 3
010202102



NOISE MARINE
HEAD 1
010202209



NOISE MARINE
HEAD 2
010202105



CHAMPION'S DOOM
SIREN HEAD
010202313



NOISE MARINE ARM 1
010202104



NOISE MARINE ARM 2
010202208



NOISE MARINE
CHAMPION CHAINWORD
010202312



NOISE MARINE
CHAMPION POWER FIST
010202311



NOISE MARINE
BACKPACK
010202101



SONIC BLASTER
010202103



BLASTMASTER
010202207

WEAPONS AND ARMS ARE NOT INTERCHANGEABLE



NOISE MARINE CHAMPION
WITH DOOM SIREN

NOISE MARINE CHAMPION WITH
DOOM SIREN CONSISTS OF:
1 x NOISE MARINE BODY 1
1 x CHAMPION'S DOOM SIREN HEAD
1 x NOISE MARINE CHAMPION CHAINWORD
1 x NOISE MARINE CHAMPION POWER FIST
1 x NOISE MARINE BACKPACK



NOISE MARINE WITH
SONIC BLASTER

NOISE MARINE WITH
SONIC BLASTER CONSISTS OF:
1 x NOISE MARINE BODY 3
1 x NOISE MARINE HEAD 2
1 x SONIC BLASTER
1 x NOISE MARINE ARM 1
1 x NOISE MARINE BACKPACK



NOISE MARINE WITH
BLASTMASTER

NOISE MARINE WITH
BLASTMASTER CONSISTS OF:
1 x NOISE MARINE BODY 2
1 x NOISE MARINE HEAD 1
1 x BLASTMASTER
1 x NOISE MARINE ARM 2
1 x NOISE MARINE BACKPACK



CITADEL
MINIATURES



CITADEL
MINIATURES

Design by Aly Morrison

Not suitable for children under 8 years due to small parts and essential pointed components. All models supplied unpainted.
© Copyright Games Workshop Ltd. 1998. All rights reserved.

CHAOS SPACE MARINES®

CHAOS SPACE MARINE KHORNE BERZERKER CHAMPIONS



KHORNE BERZERKER CHAMPION 1
010201701



KHORNE BERZERKER CHAMPION 2
010201702



KHORNE BERZERKER CHAMPION 3
010201703



KHORNE BERZERKER CHAMPION

A COMPLETED KHORNE BERZERKER CHAMPION CONSISTS OF:
 1 x KHORNE BERZERKER CHAMPION
 1 x CHAOS SPACE MARINE ARM SPRUE
 1 x CHAOS SPACE MARINE BACKPACK SPRUE



CHAOS SPACE MARINE TERMINATOR CHAMPION

A COMPLETED CHAOS TERMINATOR CHAMPION CONSISTS OF:
 1 x CHAOS TERMINATOR CHAMPION BODY
 1 x CHAOS TERMINATOR CHAMPION HEAD
 1 x CHAMPION RIGHT TROPHY RACK
 1 x CHAMPION LEFT TROPHY RACK
 1 x CHAOS TERMINATOR RIGHT ARM
 1 x CHAOS TERMINATOR LEFT ARM



CHAOS TERMINATOR CHAMPION BODY
010201701



CHAMPION HEAD 2
010201703



CHAMPION RIGHT TROPHY RACK
010201704



POWER AXE
010201707



CHAMPION HEAD 1
010201702



CHAMPION LEFT TROPHY RACK
010201705



LIGHTNING CLAW
010201706



CHAOS SPACE MARINE TERMINATOR CHAMPION



CHAOS SPACE MARINES®

CHAOS TERMINATORS



**CHAOS TERMINATOR
BODY 1**
010200201



**CHAOS TERMINATOR
BODY 2**
010200202



**CHAOS TERMINATOR
BODY 3**
010200203



RIGHT TROPHY RACK 1
010200204



LEFT TROPHY RACK 1
010200205



RIGHT TROPHY RACK 2
010200206



LEFT TROPHY RACK 2
010200207

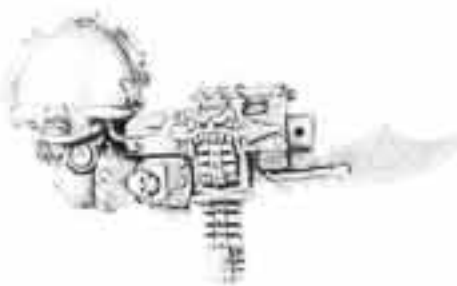

**CHAOS TERMINATOR RIGHT ARM
WITH BOLTER COMBI-WEAPON 1**
010200213



**CHAOS TERMINATOR RIGHT ARM
WITH BOLTER AND
MELTAGUN COMBI-WEAPON**
010200214

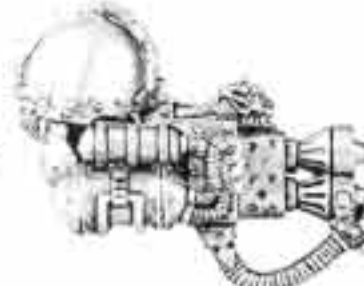

**CHAOS TERMINATOR
RIGHT ARM WITH
HEAVY FLAMER**
010201122



**CHAOS TERMINATOR
HEAD 5**
010200211



**CHAOS TERMINATOR
HEAD 2**
010200210



**CHAOS TERMINATOR RIGHT ARM
WITH BOLTER COMBI-WEAPON 2**
010200215



**CHAOS TERMINATOR RIGHT
ARM WITH BOLTER AND
FLAMER COMBI-WEAPON**
010200216

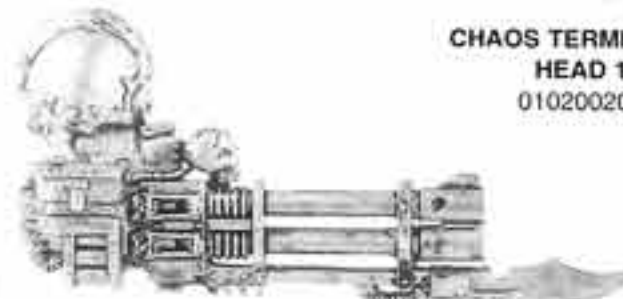

**CHAOS TERMINATOR RIGHT ARM WITH
REAPER AUTOCANNON**
010200217



**CHAOS TERMINATOR
HEAD 1**
010200208



**CHAOS TERMINATOR
HEAD 4**
010200209



**CHAOS TERMINATOR
HEAD 3**
010200212



**CHAOS TERMINATOR LEFT
ARM WITH CHAIN-AXE**
010200218



**CHAOS TERMINATOR LEFT
ARM WITH POWER FIST**
010200219



**CHAOS TERMINATOR LEFT
ARM WITH POWER MACE**
010200220



**CHAOS TERMINATOR LEFT
ARM WITH CHAINFIST**
010200221



CHAOS TERMINATOR



**A COMPLETED
CHAOS TERMINATOR CONSISTS OF:**
1 x CHAOS TERMINATOR BODY
1 x CHAOS TERMINATOR LEFT ARM
1 x CHAOS TERMINATOR RIGHT ARM
1 x CHAOS TERMINATOR RIGHT TROPHY RACK
1 x CHAOS TERMINATOR LEFT TROPHY RACK
1 x CHAOS TERMINATOR HEAD



CHAOS SPACE MARINES®

CHAOS SPACE MARINE ICON BEARER



ICON BEARER
010202401



FLESH BANNER
010202402



RAPTUROUS STANDARD
010202403



CHAOS SPACE MARINE ICON BEARER
WITH WARP BANNER



BLASTED STANDARD
010202404



CHAOS UNDIVIDED ICON
010202405



WARP BANNER
010202406

A COMPLETED CHAOS SPACE
MARINE ICON BEARER
CONSISTS OF:
1 x ICON BEARER
1 x CHAOS BANNER
1 x BACKPACK SPRUE

CHAOS SPACE MARINE KHORNE ICON BEARER



KHORNE ICON
BEARER BODY
010201801



KHORNE ICON
010201802



KHORNE ICON BEARER

A COMPLETED CHAOS SPACE
MARINE KHORNE ICON BEARER
CONSISTS OF:
1 x KHORNE ICON BEARER BODY
1 x KHORNE ICON
1 x BACKPACK SPRUE

PLAGUE MARINE ICON BEARER



PLAGUE MARINE ICON
010201902



PLAGUE MARINE
ICON BEARER BODY
010201901



PLAGUE MARINE ICON BEARER

A COMPLETED PLAGUE MARINE
ICON BEARER
CONSISTS OF:
1 x PLAGUE MARINE ICON
BEARER BODY
1 x PLAGUE MARINE ICON
1 x BACKPACK SPRUE



CHAOS SPACE MARINES®

SORCERERS



CHAOS SPACE MARINE
SORCERER BODY 1
010201301

A COMPLETED CHAOS SPACE MARINE
SORCERER 1 CONSISTS OF:
1 x CHAOS SPACE MARINE SORCERER BODY 1
1 x CHAOS SPACE MARINE
SORCERER BACKPACK 1
1 x CHAOS SPACE MARINE SORCERER
BOLT PISTOL ARM 1



CHAOS SPACE MARINE
SORCERER BOLT PISTOL ARM 1
010201303



CHAOS SPACE MARINE
SORCERER BACKPACK 1
010201302



CHAOS SPACE MARINE SORCERER



CHAOS SPACE MARINE
SORCERER BODY 2
010201304

A COMPLETED CHAOS SPACE MARINE
SORCERER 2 CONSISTS OF:
1 x CHAOS SPACE MARINE SORCERER BODY 2
1 x CHAOS SPACE MARINE
SORCERER BACKPACK 2
1 x CHAOS SPACE MARINE SORCERER
BOLT PISTOL ARM 2



CHAOS SPACE MARINE
SORCERER BOLT PISTOL ARM 2
010201305



CHAOS SPACE MARINE
SORCERER BACKPACK 2
010201306



CHAOS SPACE MARINE SORCERER



CHAOS SPACE MARINE
SORCERER BODY 3
010201307

A COMPLETED CHAOS SPACE MARINE
SORCERER 3 CONSISTS OF:
1 x CHAOS SPACE MARINE
SORCERER BODY 3
1 x CHAOS SPACE MARINE
SORCERER BACKPACK 2
1 x CHAOS SPACE MARINE
SORCERER PLASMA PISTOL



CHAOS SPACE MARINE
SORCERER PLASMA PISTOL
010201308



CHAOS SPACE MARINE
SORCERER BACKPACK 2
010201306



CHAOS SPACE MARINE SORCERER

CHAOS SPACE MARINES®

ABADDON THE DESPOILER, WARMASTER OF CHAOS



ABADDON'S HEAD
010202602



THE TALON OF HORUS
010202605



ABADDON'S LEFT
TROPHY RACK
010202604



ABADDON'S RIGHT
TROPHY RACK
010202603



ABADDON'S BODY
010202601

THE COMPLETE ABADDON THE
DESPOILER, WARMASTER OF CHAOS
CONSISTS OF:
1 x ABADDON'S HEAD
1 x ABADDON'S BODY
1 x ABADDON'S RIGHT TROPHY RACK
1 x ABADDON'S LEFT TROPHY RACK
1 x THE TALON OF HORUS
1 x DAEMON SWORD DRACH'NYEN



DAEMON SWORD DRACH'NYEN
010202606



ABADDON THE DESPOILER,
WARMASTER OF CHAOS



CHAOS SPACE MARINES®

FABIUS BILE



FABIUS BILE BODY
010200601



ROD OF TORMENT
010200603



CHIRURGEON
BACKPACK
010200604



XYCLOS NEEDLER
010200602



CHIRURGEON ARM 1
010200605



CHIRURGEON ARM 2
010200606

A COMPLETED FABIUS BILE CONSISTS OF:

- 1 x FABIUS BILE BODY
- 1 x CHIRURGEON BACKPACK
- 1 x ROD OF TORMENT
- 1 x XYCLOS NEEDLER
- 1 x CHIRURGEON ARM 1
- 1 x CHIRURGEON ARM 2



FABIUS BILE

KHARN THE BETRAYER



KHARN'S HEAD
010201402



KHARN'S
PLASMA PISTOL
010201403



KHARN'S BODY
010201401

A COMPLETED KHARN THE
BETRAYER CONSISTS OF:
1 x KHARN'S BODY
1 x KHARN'S BACKPACK
1 x KHARN'S PLASMA PISTOL
1 x KHARN'S HEAD



KHARN'S BACKPACK
010201404



KHARN THE BETRAYER

AHRIMAN



AHRIMAN'S HEAD
010201603



AHRIMAN'S BACKPACK
010201604



AHRIMAN'S BODY
010201601



BLACK STAFF OF AHRIMAN
010201602

A COMPLETED
AHRIMAN
CONSISTS OF:
1 x AHRIMAN'S BODY
1 x BLACK STAFF OF
AHRIMAN
1 x AHRIMAN'S HEAD
1 x AHRIMAN'S
BACKPACK



AHRIMAN



Designed by Jes Goodwin

Not suitable for children under 36 months due to small parts and essential pointed components. All models supplied unpainted.
© Copyright Games Workshop Ltd., 1997. All rights reserved.

CHAOS SPACE MARINES®

CHAOS SPACE MARINE DREADNOUGHT



CHAOS SPACE MARINE DREADNOUGHT



**THE COMPLETE CHAOS SPACE
MARINE DREADNOUGHT
CONTAINS:**

- 1 x SARCOPHAGUS
- 1 x REAR BODY
- 1 x LOWER BODY
- 1 x LEGS
- 2 x FEET
- 1 x POWER PLANT
- 1 x RIGHT ARM WEAPON
- 1 x LEFT SHOULDER
- 1 x LEFT ARM WEAPON
- 2 x ASSAULT LAUNCHERS
- 1 x TROPHY RACK



TROPHY RACK
010200307



ASSAULT LAUNCHER
010200308



SARCOPHAGUS
010200301



LOWER BODY
010200304



POWER PLANT
010200305



REAR BODY
010200303



FOOT
010200306



LEGS
010200302



CHAOS SPACE MARINES®

CHAOS SPACE MARINE DREADNOUGHT

THIS CHAOS DREADNOUGHT CAN BE USED BY ANY CHAOS SPACE MARINE TRAITOR LEGION. A CHAOS DREADNOUGHT MAY BE ARMED WITH ANY COMBINATION OF WEAPONS PICTURED IN THIS ASSEMBLY DIAGRAM.

WHEN ORDERING YOUR CHAOS DREADNOUGHT THROUGH MAIL ORDER PLEASE STATE WHICH WEAPONS YOU REQUIRE.

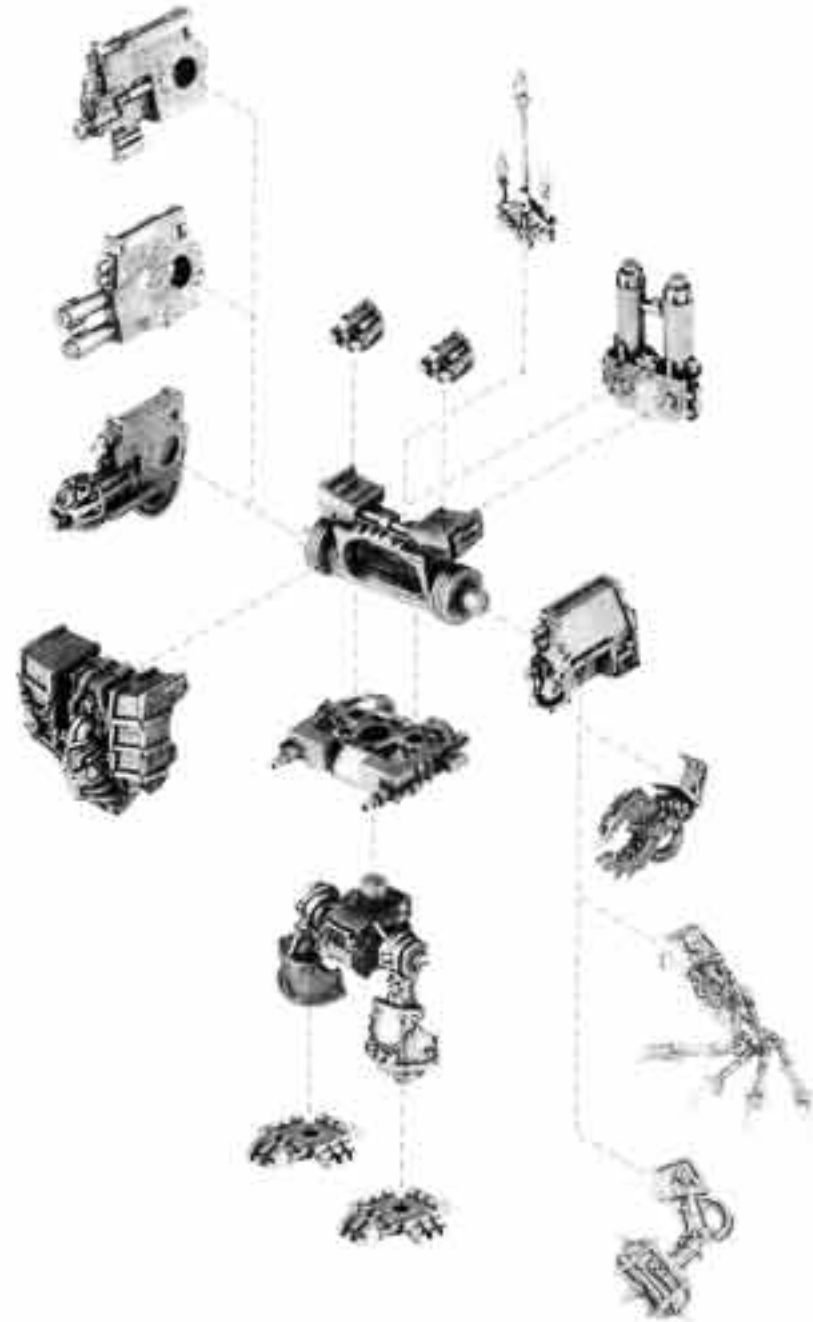

CHAOS DREADNOUGHT RIGHT ARM WEAPONS

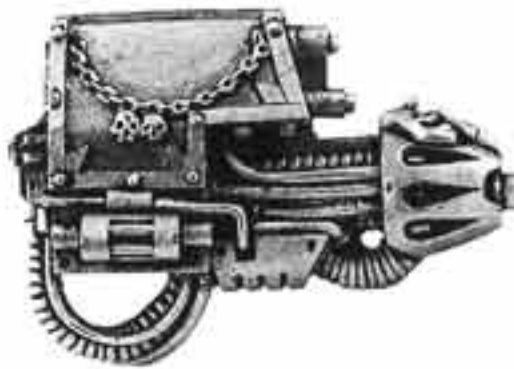

HEAVY PLASMA GUN
010200309

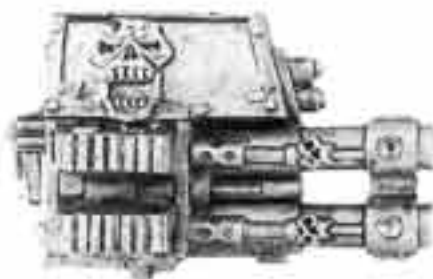

TWIN AUTOCANNON
010200310



TWIN HEAVY BOLTER
010200314

CHAOS DREADNOUGHT LEFT ARM WEAPONS



LEFT SHOULDER
010200311



POWER SCOURGE
010200312



POWER CLAW
010200313



THUNDER HAMMER
010200315



Designed by Dave Andrews

Not suitable for children under 8 years due to small parts and essential pointed components. All models supplied unpainted.
© Copyright Games Workshop Ltd. 1998. All rights reserved.

CHAOS SPACE MARINES®

JUGGERNAUT OF KHORNE



CHAMPION OF KHORNE BODY
010200101



CHAMPION OF KHORNE ARM
010200102



JUGGERNAUT
HEAD PLATE
010200104



JUGGERNAUT BODY
010200103



JUGGERNAUT HEAD
010200105



JUGGERNAUT
FRONT RIGHT LEG
010200106



JUGGERNAUT
FRONT LEFT LEG
010200107



JUGGERNAUT
REAR RIGHT LEG
010200108



JUGGERNAUT
REAR LEFT LEG
010200109

- A COMPLETED
JUGGERNAUT OF KHORNE CONSISTS OF:**
- 1 x CHAMPION OF KHORNE BODY
 - 1 x CHAMPION OF KHORNE ARM
 - 1 x JUGGERNAUT BODY
 - 1 x JUGGERNAUT FRONT LEFT LEG
 - 1 x JUGGERNAUT FRONT RIGHT LEG
 - 1 x JUGGERNAUT REAR LEFT LEG
 - 1 x JUGGERNAUT REAR RIGHT LEG
 - 1 x JUGGERNAUT HEAD
 - 1 x JUGGERNAUT HEAD PLATE
 - 1 x PLASTIC CHAOS BACKPACK SPRUE



CHAOS JUGGERNAUT OF KHORNE



CHAOS

CHAOS CULTISTS



DEMAGOGUE 1
010203601



DEMAGOGUE 2
010203602



CHAOS CULTIST 1
010203603



CHAOS CULTIST 2
010203604



CHAOS CULTIST 3
010203605



CHAOS CULTIST 4
010203606



CHAOS CULTIST 5
010203607



CHAOS CULTIST 6
010203608



CITADEL
MINIATURES



CITADEL
MINIATURES

Designed by Paul Muller

Not suitable for children under 8 years due to small parts and essential pointed components. All models supplied unpainted.
© Copyright Games Workshop Ltd. 1998. All rights reserved.

IMPERIAL GUARD®

JUNGLE FIGHTERS OF CATACHAN



JUNGLE FIGHTER
WITH LASGUN 4
010504801



JUNGLE FIGHTER
WITH LASGUN 1
010504802



JUNGLE FIGHTER
WITH LASGUN 2
010504803



JUNGLE FIGHTER
SERGEANT 1
010504804



COMM-LINK
010505601

CATACHAN JUNGLE FIGHTER
COMM-LINK OPERATOR
010505602



JUNGLE FIGHTER
WITH LASGUN 3
010504805



JUNGLE FIGHTER
WITH MELTA-GUN
010504806



JUNGLE FIGHTER
WITH FLAMER
010505612

JUNGLE FIGHTER MISSILE LAUNCHER



JUNGLE FIGHTER
MISSILE LAUNCHER
010504809



MISSILE
LAUNCHER STAND
010504810



JUNGLE FIGHTER
MISSILE FIRER
010504808



JUNGLE FIGHTER
LOADER
010504807

THE COMPLETE
JUNGLE FIGHTERS OF CATACHAN
MISSILE LAUNCHER
CONSISTS OF:
1 x CATACHAN JUNGLE FIGHTER
MISSILE FIRER
1 x MISSILE LAUNCHER
1 x MISSILE LAUNCHER STAND
1 x CATACHAN JUNGLE FIGHTER
LOADER

JUNGLE FIGHTER LIEUTENANT



JUNGLE FIGHTER
LIEUTENANT
010504701



JUNGLE FIGHTER WITH MISSILE LAUNCHER



IMPERIAL GUARD[®]

JUNGLE FIGHTERS OF CATACHAN



JUNGLE FIGHTER
SERGEANT 2
010503711



JUNGLE FIGHTER
WITH LASGUN 5
010504626



JUNGLE FIGHTER
WITH LASGUN 6
010504627



JUNGLE FIGHTER
WITH LASGUN 7
010504628



JUNGLE FIGHTER
WITH LASGUN 8
010504629

JUNGLE FIGHTER LASCANNON



CATACHAN JUNGLE FIGHTER
LASCANNON GUNNER
010502322



CATACHAN JUNGLE FIGHTER
LASCANNON LOADER
010502321



CATACHAN JUNGLE FIGHTER LASCANNON

A COMPLETE JUNGLE FIGHTER
LASCANNON CONSISTS OF:
1 x LASCANNON
1 x LASCANNON STAND
1 x LASCANNON SHIELD
2 x WHEELS
1 x CATACHAN JUNGLE FIGHTER
GUNNER
1 x CATACHAN JUNGLE FIGHTER
LOADER



LASCANNON
010500409



LASCANNON SHIELD
010500410



WHEEL
010504913



LASCANNON STAND
010500411

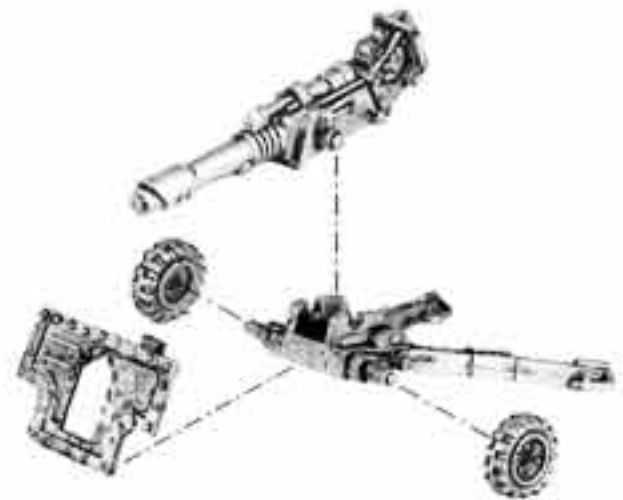

JUNGLE FIGHTER HEAVY BOLTER



CATACHAN JUNGLE
FIGHTER
GUNNER BODY
010502214



CATACHAN JUNGLE FIGHTER
HEAVY BOLTER LOADER
010502216



CATACHAN JUNGLE
FIGHTER
GUNNER LEGS
010502215



HEAVY BOLTER
010504912



HEAVY BOLTER TRAIL
010504911



HEAVY BOLTER SHIELD
010504910



CATACHAN JUNGLE FIGHTER HEAVY BOLTER

A COMPLETE JUNGLE FIGHTER
HEAVY BOLTER CONSISTS OF:
1 x CATACHAN JUNGLE FIGHTER
GUNNER BODY
1 x CATACHAN JUNGLE FIGHTER
GUNNER LEGS
1 x HEAVY BOLTER
1 x TRAIL
1 x SHIELD
2 x WHEELS
1 x JUNGLE FIGHTER LOADER



Jungle Fighters designed by Michael Perry, Heavy weapons designed by Norman Swales

Not suitable for children under 36 months due to small parts and essential pointed components. All models supplied unpainted.

© Copyright Games Workshop Ltd., 1997. All rights reserved.

IMPERIAL GUARD

JUNGLE FIGHTERS OF CATACHAN MORTAR



CATACHAN MORTAR OPERATOR
010508001



CATACHAN MORTAR LOADER
010508002



MORTAR BARREL
010505010



SHELL
010508303



MORTAR STAND
010505009

A COMPLETE CATACHAN MORTAR CONSISTS OF:
1 x CATACHAN MORTAR OPERATOR
1 x CATACHAN MORTAR LOADER
1 x SHELL
1 x MORTAR BARREL
1 x MORTAR STAND



JUNGLE FIGHTERS MORTAR

JUNGLE FIGHTERS OF CATACHAN AUTOCANNON



CATACHAN AUTOCANNON LOADER
010508101



CATACHAN GUNNER LEGS
010502215



CATACHAN GUNNER TORSO 2
010508102



SHIELD
010504910



CATACHAN GUNNER TORSO 1
010502214

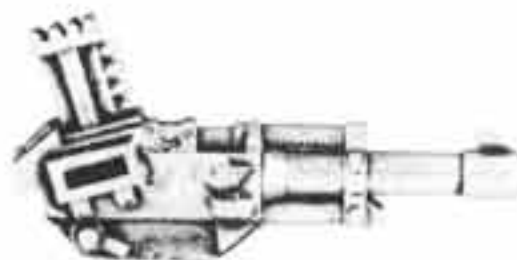

AUTOCANNON
010500512



WHEEL
010504913



TRAIL
010504911

A COMPLETE CATACHAN AUTOCANNON CONSISTS OF:
1 x CATACHAN AUTOCANNON LOADER
1 x CATACHAN GUNNER BODY
1 x CATACHAN GUNNER LEGS
1 x SHIELD
1 x TRAIL
1 x AUTOCANNON
2 x WHEELS

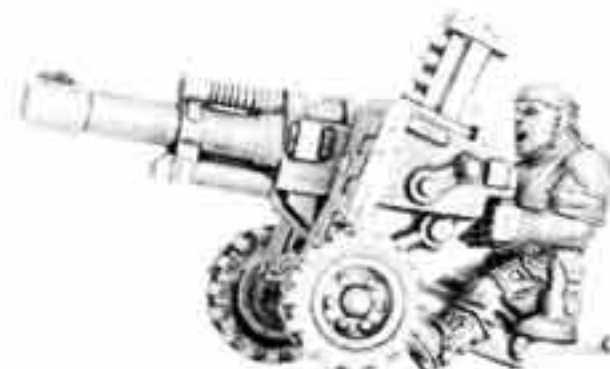

JUNGLE FIGHTERS AUTOCANNON



IMPERIAL GUARD®

CADIAN SHOCK TROOPS



CADIAN SHOCK TROOP
WITH LASGUN 1
010504901



CADIAN SHOCK TROOP
WITH LASGUN 4
010504902



CADIAN SHOCK TROOP
WITH LASGUN 3
010504903



CADIAN SHOCK TROOP
WITH LASGUN 2
010504904



CADIAN SHOCK
TROOP SERGEANT 1
010504905



CADIAN SHOCK TROOP
WITH FLAMER
010504906

CADIAN SHOCK TROOP LIEUTENANT



CADIAN SHOCK TROOP
LIEUTENANT
010505101

CADIAN SHOCK TROOP HEAVY BOLTER



CADIAN SHOCK TROOP
LOADER
010504907

A COMPLETE CADIAN SHOCK TROOP
HEAVY BOLTER CONSISTS OF:
1 x CADIAN SHOCK TROOP GUNNER BODY
1 x CADIAN SHOCK TROOP GUNNER LEGS
1 x HEAVY BOLTER
1 x TRAIL
1 x SHIELD
2 x WHEELS
1 x CADIAN SHOCK TROOP LOADER



CADIAN SHOCK TROOP HEAVY BOLTER



TRAIL
010504911



HEAVY BOLTER
010504912



SHIELD
010504910



CADIAN SHOCK TROOP
GUNNER BODY
010504908



CADIAN SHOCK
TROOP GUNNER LEGS
010504909



WHEEL
010504913



IMPERIAL GUARD[®]

CADIAN SHOCK TROOPS



SHOCK TROOP
COMMLINK OPERATOR
010505703



SHOCK TROOP WITH
LASGUN 5
010500715



SHOCK TROOP
SERGEANT 2
010503818



SHOCK TROOP WITH
MELTA-GUN
010505719



COMM-LINK
010505601



SHOCK TROOP WITH
LASGUN 6
010500717



SHOCK TROOP WITH
LASGUN 7
010500714



SHOCK TROOP WITH
LASGUN 8
010500716

CADIAN SHOCK MISSILE LAUNCHER

A COMPLETED CADIAN SHOCK TROOP
MISSILE LAUNCHER

CONSISTS OF:

- 1 x CADIAN SHOCK TROOP MISSILE
FIRER
- 1 x CADIAN SHOCK TROOP MISSILE
LAUNCHER
- 1 x MISSILE LAUNCHER STAND
- 1 x SHOCK TROOP LOADER



CADIAN SHOCK TROOPER WITH MISSILE
LAUNCHER



MISSILE LAUNCHER
STAND
010504810



CADIAN SHOCK TROOP
MISSILE LAUNCHER
010502625



CADIAN SHOCK TROOP
MISSILE FIRER
010502624



CADIAN SHOCK TROOP
MISSILE LOADER
010502623

CADIAN SHOCK TROOP AUTOCANNON



CADIAN SHOCK TROOP
GUNNER BODY
010504908



CADIAN SHOCK TROOP
GUNNER LEGS
010504909



SHIELD
010504910



AUTOCANNON
010500512



TRAIL
010504911



WHEEL
010504913



CADIAN SHOCK TROOP AUTOCANNON

- A COMPLETE
CADIAN SHOCK TROOP
AUTOCANNON
CONSISTS OF:
- 1 x CADIAN SHOCK TROOP
GUNNER BODY
 - 1 x CADIAN SHOCK TROOP
GUNNER LEGS
 - 1 x AUTOCANNON
 - 1 x TRAIL
 - 1 x SHIELD
 - 2 x WHEELS
 - 1 x CADIAN SHOCK TROOP
LOADER



CADIAN SHOCK TROOP
AUTOCANNON LOADER
010502521



IMPERIAL GUARD

CADIAN SHOCK TROOP MORTAR



CADIAN MORTAR OPERATOR
010508301



CADIAN MORTAR LOADER
010508302



MORTAR BARREL
010505010



SHELL
010508303



MORTAR STAND
010505009

A COMPLETE CADIAN MORTAR CONSISTS OF:
1 x CADIAN MORTAR OPERATOR
1 x CADIAN MORTAR LOADER
1 x SHELL
1 x MORTAR BARREL
1 x MORTAR STAND



CADIAN SHOCK TROOP MORTAR

CADIAN SHOCK TROOP LASCANNON



CADIAN LASCANNON LOADER
010508201



CADIAN LASCANNON OPERATOR
010508202



WHEEL
010504913



LASCANNON
010500409



LASCANNON SHIELD
010500410

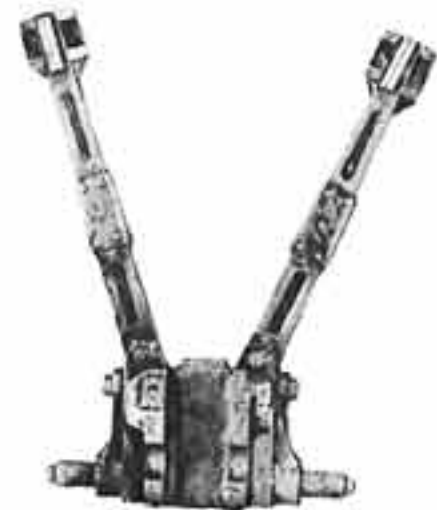

LASCANNON STAND
010500411

A COMPLETE CATACHAN AUTOCANNON CONSISTS OF:
1 x CATACHAN AUTOCANNON LOADER
1 x CATACHAN GUNNER BODY
1 x CATACHAN GUNNER LEGS
1 x SHIELD
1 x TRAIL
1 x AUTOCANNON
2 x WHEELS

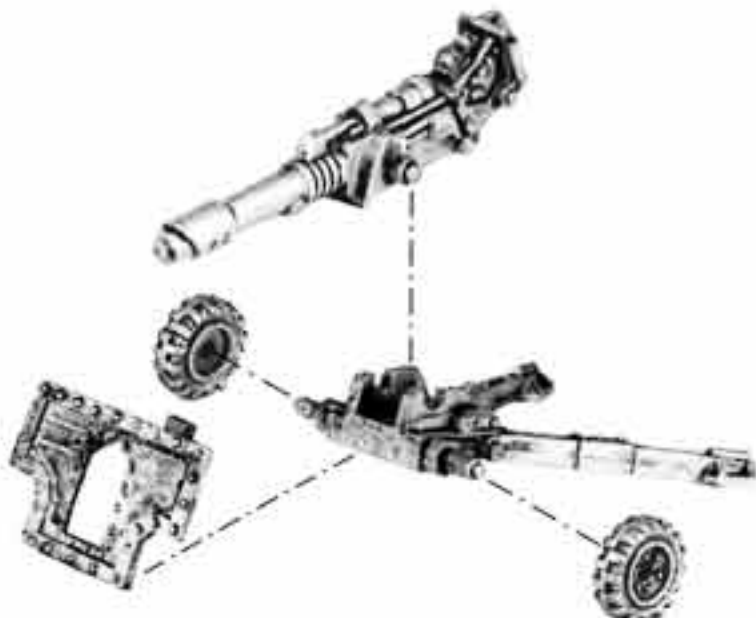

CADIAN SHOCK TROOP LASCANNON



Designed by Michael Perry. Lascannon & mortar designed by Norman Swales

Not recommended for children under 8 years due to small parts and essential pointed components. All models supplied unpainted.
© Copyright Games Workshop Ltd. 1998. All rights reserved.

IMPERIAL GUARD[®]

ICE WARRIORS OF VALHALLA



VALHALLAN ICE WARRIOR
WITH LASGUN 1
010505001



VALHALLAN ICE
WARRIOR SERGEANT 1
010505006



VALHALLAN ICE WARRIOR
WITH LASGUN 2
010505002



VALHALLAN ICE WARRIOR
WITH LASGUN 3
010505003



VALHALLAN ICE WARRIOR
WITH LASGUN 4
010505004



VALHALLAN ICE
WARRIOR WITH FLAMER
010505005



VALHALLAN ICE WARRIOR WITH
MELTA-GUN
010505816



VALHALLAN ICE WARRIOR
WITH GRENADE LAUNCHER
010505817

ICE WARRIOR MORTAR



VALHALLAN ICE WARRIOR
MORTAR LOADER
010505007



VALHALLAN ICE WARRIOR
MORTAR OPERATOR
010505008

A COMPLETE ICE WARRIORS
OF VALHALLA MORTAR
CONSISTS OF:
1 x MORTAR BARREL
1 x MORTAR STAND
1 x VALHALLAN ICE WARRIOR
OPERATOR
1 x VALHALLAN ICE WARRIOR
LOADER

ICE WARRIOR LIEUTENANT



VALHALLAN ICE
WARRIOR LIEUTENANT
010500901

ICE WARRIOR COMM-LINK



VALHALLAN ICE WARRIOR
COMM-LINK OPERATOR
010505804



COMM-LINK
010505601



MORTAR STAND
010505009



MORTAR BARREL
010505010



VALHALLAN ICE WARRIOR MORTAR



IMPERIAL GUARD[®]

ICE WARRIORS OF VALHALLA



VALHALLAN ICE WARRIOR
SERGEANT 2
010503915



VALHALLAN ICE WARRIOR
WITH LASGUN 5
010500813



VALHALLAN ICE WARRIOR
WITH LASGUN 8
010500811



VALHALLAN ICE WARRIOR
WITH LASGUN 7
010500812



VALHALLAN ICE WARRIOR
WITH LASGUN 6
010500814

ICE WARRIORS LASCANNON



VALHALLAN ICE WARRIOR
LASCANNON OPERATOR
010502921



VALHALLAN ICE WARRIOR
LASCANNON LOADER
010502920



ICE WARRIORS OF VALHALLA LASCANNON

A COMPLETED
LASCANNON
CONSISTS OF:
1 x LASCANNON
1 x LASCANNON SHIELD
1 x LASCANNON STAND
2 x WHEELS
1 x VALHALLAN ICE
WARRIOR OPERATOR
1 x VALHALLAN ICE
WARRIOR LOADER



LASCANNON
010500409



LASCANNON SHIELD
010500410



WHEEL
010504913



LASCANNON STAND
010500411

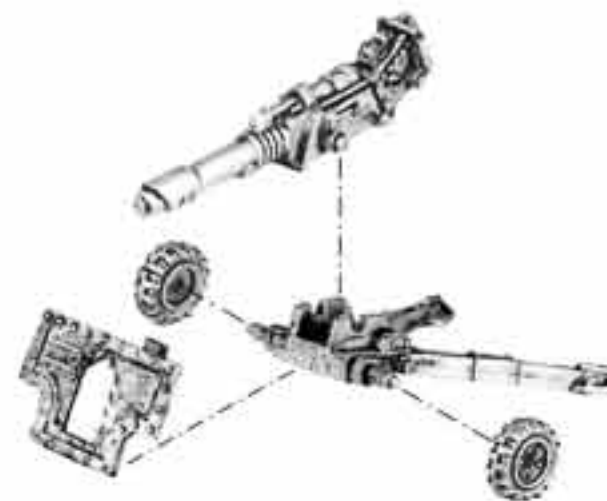

ICE WARRIORS HEAVY BOLTER



VALHALLAN ICE
WARRIOR GUNNER
BODY
010502817



WHEEL
010504913



VALHALLAN ICE WARRIOR
LOADER
010502819



VALHALLAN ICE WARRIORS
HEAVY BOLTER

A COMPLETED ICE WARRIORS
OF VALHALLA HEAVY BOLTER
CONSISTS OF:
1 x VALHALLAN ICE WARRIOR
GUNNER BODY
1 x VALHALLAN ICE WARRIOR
GUNNER LEGS
1 x VALHALLAN ICE WARRIOR
LOADER
1 x HEAVY BOLTER
1 x SHIELD
1 x TRAIL
2 x WHEELS



VALHALLAN ICE
WARRIOR GUNNER LEGS
010502818



SHIELD
010504910



TRAIL
010504911



HEAVY BOLTER
010504912



Designed by Alan Perry, heavy weapons designed by Norman Swales

Not suitable for children under 8 years due to small parts and essential pointed components. All models supplied unpainted.
© Copyright Games Workshop Ltd. 1998. All rights reserved.

IMPERIAL GUARD

VALHALLAN ICE WARRIOR MISSILE LAUNCHER

A COMPLETE VALHALLAN MISSILE LAUNCHER CONSISTS OF:
 1 x VALHALLAN MISSILE LOADER
 1 x VALHALLAN MISSILE LAUNCHER BODY
 1 x VALHALLAN MISSILE LAUNCHER ARM



VALHALLAN ICE WARRIOR MISSILE LOADER
010508501



VALHALLAN ICE WARRIOR MISSILE LAUNCHER ARM
010508503



VALHALLAN ICE WARRIOR MISSILE LAUNCHER BODY
010508502



A COMPLETED VALHALLAN ICE WARRIOR MISSILE LAUNCHER

VALHALLAN ICE WARRIOR AUTOCANNON

A COMPLETE VALHALLAN AUTOCANNON CONSISTS OF:
 1 x VALHALLAN AUTOCANNON LOADER
 1 x VALHALLAN GUNNER BODY
 1 x VALHALLAN GUNNER LEGS
 1 x SHIELD
 1 x TRAIL
 1 x AUTOCANNON
 2 x WHEELS



VALHALLAN ICE WARRIOR AUTOCANNON LOADER
010508401



VALHALLAN ICE WARRIOR GUNNER LEGS
010502818



VALHALLAN ICE WARRIOR GUNNER TORSO 2
010508402



SHIELD
010504910



VALHALLAN ICE WARRIOR GUNNER TORSO 1
010502817

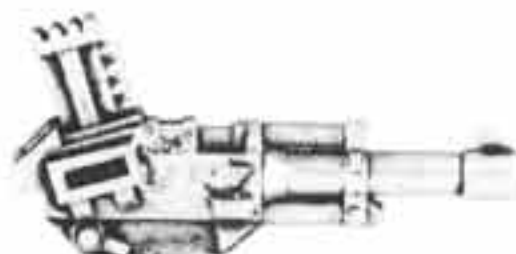

AUTOCANNON
010500512



WHEEL
010504913



TRAIL
010504911



VALHALLAN ICE WARRIOR AUTOCANNON



IMPERIAL GUARD[®]

MORDIAN IRON GUARD



MORDIAN IRON GUARD
WITH LASGUN 4
010500402



MORDIAN IRON GUARD
WITH LASGUN 2
010500401



MORDIAN IRON GUARD
WITH LASGUN 1
010500403

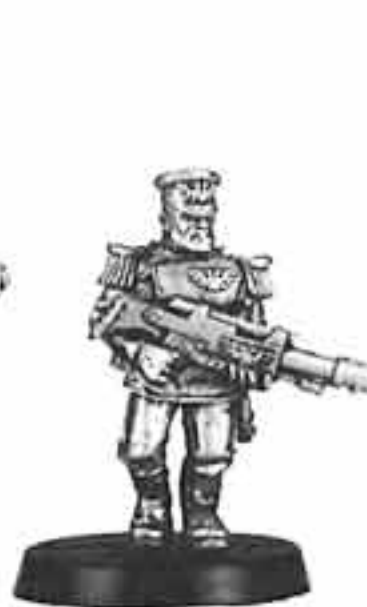

MORDIAN IRON GUARD
WITH LASGUN 3
010500404



MORDIAN IRON GUARD
WITH GRENADE LAUNCHER
010500405



MORDIAN IRON GUARD
SERGEANT 1
010500406



MORDIAN IRON GUARD
WITH FLAMER
010505919



MORDIAN IRON GUARD
WITH MELTA-GUN
010505918

IRON GUARD LIEUTENANT



MORDIAN IRON GUARD LIEUTENANT
010501001

MORDIAN IRON GUARD LASCANNON



MORDIAN IRON GUARD
LASCANNON LOADER
010500408



MORDIAN IRON GUARD
LASCANNON OPERATOR
010500407



COMPLETED LASCANNON

A COMPLETED
MORDIAN IRON GUARD
LASCANNON CONSISTS OF:
1 x MORDIAN IRON GUARD
LASCANNON OPERATOR
1 x MORDIAN IRON GUARD
LASCANNON LOADER
1 x LASCANNON
1 x LASCANNON SHIELD
1 x LASCANNON STAND
2 x WHEELS



LASCANNON STAND
010500411



LASCANNON
010500409



LASCANNON SHIELD
010500410



WHEEL
010504913



Designed by Michael Perry, Lascannon designed by Norman Swales

Not suitable for children under 8 years due to small parts and essential pointed components. All models supplied unpainted.
© Copyright Games Workshop Ltd. 1998. All rights reserved.

IMPERIAL GUARD[®]

MORDIAN IRON GUARD



MORDIAN IRON GUARD
SERGEANT
010504017



MORDIAN IRON GUARD
WITH LASGUN 5
010501112



MORDIAN IRON GUARD
WITH LASGUN 8
010501114



MORDIAN IRON GUARD
WITH LASGUN 6
010501115



MORDIAN IRON GUARD
WITH LASGUN 7
010501116

MORDIAN IRON GUARD MORTAR



MORTAR STAND
010505010



MORTAR BARREL
010505009



MORDIAN IRON GUARD
MORTAR LOADER
010503224



MORDIAN IRON GUARD
MORTAR OPERATOR
010503223

A COMPLETED
MORDIAN IRON GUARD MORTAR
CONSISTS OF:
1 x MORTAR BARREL
1 x MORTAR STAND
1 x IRON GUARD MORTAR OPERATOR
1 x IRON GUARD MORTAR LOADER



IMPERIAL MORDIAN
IRON GUARD MORTAR

MORDIAN IRON GUARD HEAVY BOLTER



MORDIAN IRON GUARD
GUNNER BODY
010503120



MORDIAN IRON GUARD
HEAVY BOLTER LOADER
010503122

A COMPLETED
MORDIAN IRON GUARD
HEAVY BOLTER
CONSISTS OF:
1 x MORDIAN IRON GUARD
GUNNER BODY
1 x MORDIAN IRON GUARD HEAVY
BOLTER GUNNER LEGS
1 x MORDIAN IRON GUARD HEAVY
BOLTER LOADER
1 x HEAVY BOLTER
1 x SHIELD
1 x TRAIL
2 x WHEELS



MORDIAN IRON GUARD HEAVY BOLTER



SHIELD
010504910



MORDIAN IRON GUARD
GUNNER LEGS
010503121



HEAVY BOLTER
010504912



TRAIL
010504911



WHEEL
010504913



IMPERIAL GUARD

MORDIAN IRON GUARD MISSILE LAUNCHER



MORDIAN IRON GUARD
MISSILE LOADER
010508601

A COMPLETE MORDIAN
MISSILE LAUNCHER CONSISTS OF:
1 x MORDIAN MISSILE LOADER
1 x MORDIAN MISSILE LAUNCHER BODY
1 x MORDIAN MISSILE ARM



MORDIAN IRON GUARD
MISSILE LAUNCHER
ARM
010508603



MORDIAN IRON GUARD
MISSILE LAUNCHER
BODY
010508602



MORDIAN IRON GUARD
MISSILE LAUNCHER
COMPLETE

MORDIAN IRON GUARD AUTOCANNON



MORDIAN IRON GUARD
GUNNER LEGS
010503121



SHIELD
010504910



MORDIAN IRON GUARD
AUTOCANNON LOADER
010508701



MORDIAN IRON GUARD
GUNNER TORSO 1
010508702

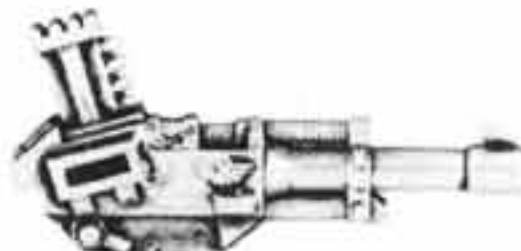

AUTOCANNON
010500512



WHEEL
010504913



MORDIAN IRON GUARD
GUNNER TORSO 2
010503120

A COMPLETE MORDIAN
AUTOCANNON CONSISTS OF:
1 x MORDIAN AUTOCANNON LOADER
1 x MORDIAN GUNNER BODY
1 x MORDIAN GUNNER LEGS
1 x SHIELD
1 x TRAIL
1 x AUTOCANNON
2 x WHEELS



TRAIL
010504911

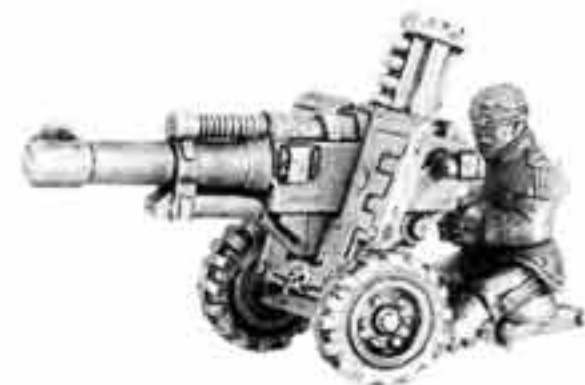

MORDIAN IRON GUARD AUTOCANNON



Designed by Michael Perry. Autocannon designed by Norman Swales

Not recommended for children under 8 years due to small parts and essential pointed components. All models supplied unpainted.
© Copyright Games Workshop Ltd. 1998. All rights reserved.

IMPERIAL GUARD®

TALLARN DESERT RAIDERS



TALLARN DESERT RAIDER
WITH MELTA-GUN
010500501



TALLARN DESERT RAIDER
WITH LASGUN 2
010500502



TALLARN DESERT RAIDER
WITH LASGUN 4
010500503



TALLARN DESERT RAIDER
WITH LASGUN 1
010500504



TALLARN DESERT RAIDER
WITH LASGUN 3
010500505



TALLARN DESERT RAIDER
SERGEANT 1
010500506

TALLARN DESERT RAIDER LIEUTENANT



TALLARN DESERT RAIDER
LIEUTENANT
010501401

TALLARN DESERT RAIDER AUTOCANNON



TALLARN DESERT RAIDER
GUNNER LEGS
010500509



TALLARN DESERT RAIDER
GUNNER BODY
010500508



TALLARN DESERT RAIDER
AUTOCANNON LOADER
010500507

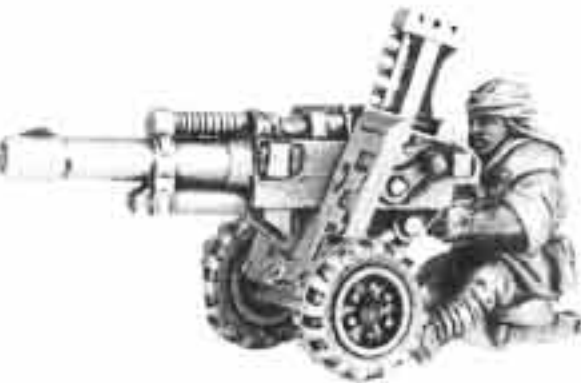

TALLARN DESERT RAIDER AUTOCANNON

A COMPLETE
TALLARN DESERT RAIDER AUTOCANNON
CONSISTS OF:
1 x TALLARN DESERT RAIDER LOADER
1 x TALLARN DESERT RAIDER GUNNER BODY
1 x DESERT RAIDER AUTOCANNON GUNNER LEGS
1 x AUTOCANNON
1 x TRAIL
1 x SHIELD
2 x WHEELS



TRAIL
010504911



WHEEL
010504913

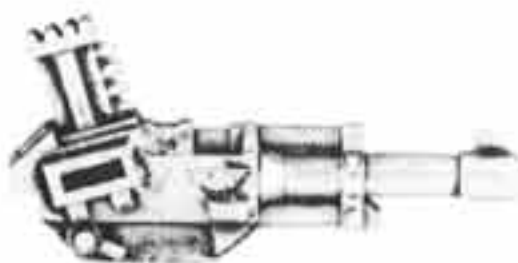

AUTOCANNON
010500512



SHIELD
010504910



IMPERIAL GUARD®

TALLARN DESERT RAIDERS



DESERT RAIDER WITH
GRENADE LAUNCHER
010506020



DESERT RAIDER
SERGEANT 2
010504118



DESERT RAIDER WITH
LASGUN 6
010501314



DESERT RAIDER WITH
LASGUN 8
010501315



DESERT RAIDER WITH
LASGUN 7
010501317



DESERT RAIDER WITH
LASGUN 5
010501316

TALLARN DESERT RAIDER MISSILE LAUNCHER



DESERT RAIDER
MISSILE LOADER
010503421



DESERT RAIDER
MISSILE FIRER
010503423

A COMPLETE
TALLARN DESERT RAIDER
MISSILE LAUNCHER
CONSISTS OF:

- 1 x DESERT RAIDER MISSILE FIRER
- 1 x DESERT RAIDER MISSILE LAUNCHER
- 1 x DESERT RAIDER MISSILE LOADER



A COMPLETED DESERT RAIDER
WITH MISSILE LAUNCHER



DESERT RAIDER
MISSILE LAUNCHER
010503422



Designed by Michael Perry

Not suitable for children under 8 years due to small parts and essential pointed components. All models supplied unpainted.
© Copyright Games Workshop Ltd. 1998. All rights reserved.

IMPERIAL GUARD

TALLARN DESERT RAIDER MORTAR



TALLARN DESRT RAIDER
MORTAR OPERATOR
010508901



TALLARN DESRT RAIDER
MORTAR LOADER
010508902



MORTAR BARREL
010505009



MORTAR SHELL
010508303



MORTAR STAND
010505010



TALLARN DESERT RAIDER
MORTAR

A COMPLETE TALLARN DESERT RAIDER
MORTAR CONSISTS OF:
1 x TALLARN DESERT RAIDER LOADER
1 x TALLARN DESERT RAIDER OPERATOR
1 x MORTAR BARREL
1 x MORTAR STAND
1 x MORTAR SHELL

TALLARN DESERT RAIDER HEAVY BOLTER



TALLARN DESRT RAIDER
HEAVY BOLTER LOADER
010509601



TALLARN DESERT RAIDER
GUNNER TORSO 2
010500508



TALLARN DESERT RAIDER
GUNNER TORSO 1
010509602



TALLARN DESERT RAIDER
GUNNER LEGS
010500509



TRAIL
010504911



WHEEL
010504913



SHIELD
010504910



HEAVY BOLTER
010504912

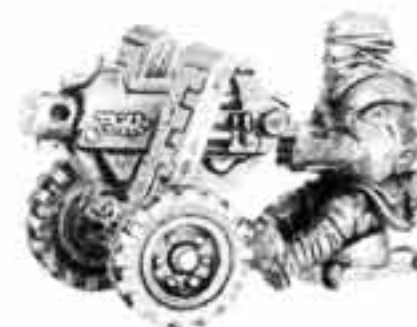

TALLARN DESERT RAIDER
HEAVY BOLTER

A COMPLETE TALLARN DESERT RAIDER
HEAVY BOLTER CONSISTS OF:
1 x TALLARN DESERT RAIDER LOADER
1 x TALLARN DESERT RAIDER TORSO
1 x TALLARN DESERT RAIDER LEGS
1 x TRAIL
1 x SHIELD
1 x HEAVY BOLTER
2 x WHEELS



IMPERIAL GUARD

TALLARN DESERT RAIDER LASCANNON



TALLARN LASCANNON
LOADER
010508801



TALLARN LASCANNON
OPERATOR
010508802

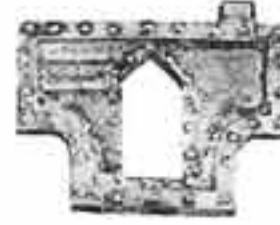

LASCANNON SHIELD
010500410



WHEEL
010504913



LASCANNON
010500512

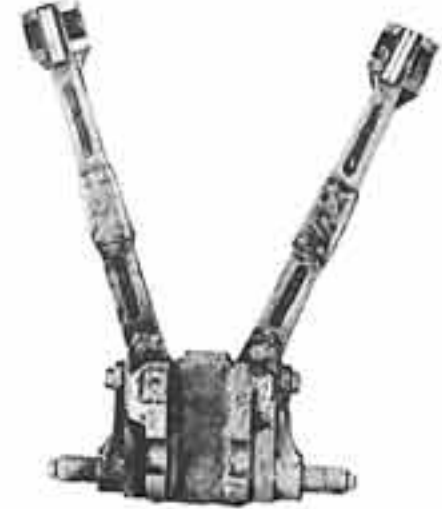

LASCANNON STAND
010508102

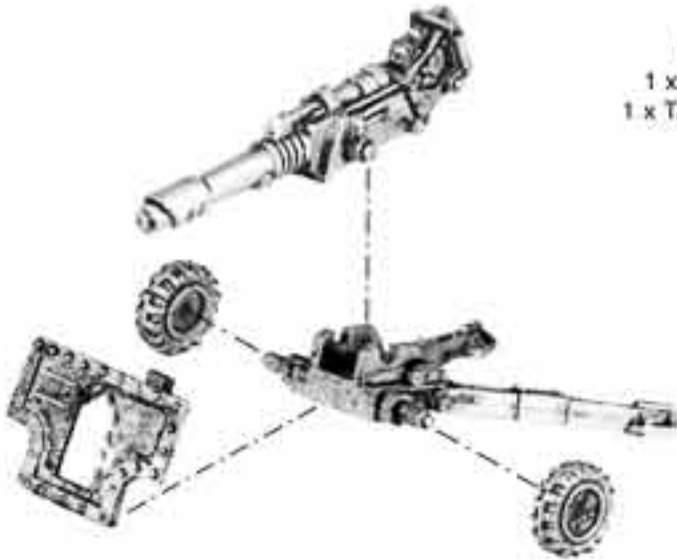

A COMPLETE TALLARN
LASCANNON CONSISTS OF:
1 x TALLARN LASCANNON LOADER
1 x TALLARN LAS CANNON OPERATOR
1 x LASCANNON
1 x LASCANNON SHIELD
1 x LASCANNON STAND
2 x WHEELS



TALLARN DESERT RAIDER LASCANNON

Designed by Michael Perry. Lascannon designed by Norman Swales



IMPERIAL GUARD[®]

TALLARN ROUGH RIDERS



TALLARN ROUGH RIDER TORSO 1
010509501



TALLARN ROUGH RIDER TORSO 2
010509502



ROUGH RIDER'S LEGS 1
010504404



ROUGH RIDER'S LEGS 2
010504405

A COMPLETE TALLARN
ROUGH RIDER CONSISTS OF:
1 x ROUGH RIDER'S TORSO
1 x ROUGH RIDER'S LEGS
1 x WEAPON
1 x PLASTIC UNARMoured HORSE



ROUGH RIDER HUNTING LANCE
010504406



ROUGH RIDER
CHAINSWORD
010504407



TALLARN ROUGH RIDERS

Designed by Alan Perry



IMPERIAL GUARD®

PRAETORIAN TROOPERS



PRAETORIAN TROOPER 1
010507501



PRAETORIAN TROOPER 2
010507502



PRAETORIAN TROOPER 3
010507503



PRAETORIAN TROOPER 4
010507703



PRAETORIAN TROOPER 5
010507601



PRAETORIAN TROOPER 7
010507603



PRAETORIAN TROOPER 8
010507701



PRAETORIAN TROOPER 9
010507702



PRAETORIAN TROOPER 6
010507602

PRAETORIAN LASCANNON



PRAETORIAN LASCANNON LOADER
010506602



PRAETORIAN LASCANNON OPERATOR
010506601



COMPLETED LASCANNON

A COMPLETED
PRAETORIAN
LASCANNON CONSISTS OF:
1 x PRAETORIAN LASCANNON
OPERATOR
1 x PRAETORIAN LASCANNON
LOADER
1 x LASCANNON
1 x LASCANNON SHIELD
1 x LASCANNON STAND
2 x WHEELS



LASCANNON STAND
010500411



LASCANNON
010500409



LASCANNON SHIELD
010500410



WHEEL
010504913



Designed by Michael Perry, Lascannon designed by Norman Swales

Not suitable for children under 8 years due to small parts and essential pointed components. All models supplied unpainted.
© Copyright Games Workshop Ltd. 1998. All rights reserved.

IMPERIAL GUARD®

PRAETORIAN COMMAND



PRAETORIAN STANDARD BEARER
010507302



PRAETORIAN LIEUTENANT
010507901



PRAETORIAN MUSICIAN
010507301

PRAETORIAN SERGEANTS



PRAETORIAN SERGEANT 1
010507101



PRAETORIAN SERGEANT 2
010507201

PRAETORIAN SPECIAL WEAPONS



PRAETORIAN WITH MELTA-GUN
010507001



PRAETORIAN WITH FLAMER
010507002



PRAETORIAN GRENADE LAUNCHER
010507401

PRAETORIAN MORTAR CREW



PRAETORIAN MORTAR OPERATOR
010506901



PRAETORIAN MORTAR LOADER
010506902



MORTAR BARREL
010505009



MORTAR STAND
010505010

A COMPLETE PRAETORIAN MORTAR
CONSISTS OF:
1 x MORTAR BARREL
1 x MORTAR STAND
1 x PRAETORIAN MORTAR OPERATOR
1 x PRAETORIAN MORTAR LOADER



CITADEL
MINIATURES



CITADEL
MINIATURES

IMPERIAL GUARD

PRAETORIAN MISSILE LAUNCHER



PRAETORIAN MISSILE LOADER
010509301

A COMPLETE PRAETORIAN MISSILE LAUNCHER CONSISTS OF:
1 x PRAETORIAN MISSILE LOADER
1 x PRAETORIAN MISSILE LAUNCHER BODY
1 x PRAETORIAN MISSILE ARM



PRAETORIAN MISSILE LAUNCHER ARM
010508603



PRAETORIAN MISSILE LAUNCHER BODY
010509302



PRAETORIAN MISSILE LAUNCHER COMPLETE

PRAETORIAN AUTOCANNON AND HEAVY BOLTER



PRAETORIAN GUNNER LEGS
010503121



PRAETORIAN HEAVY BOLTER LOADER
010506701



PRAETORIAN AUTOCANNON LOADER 1
010508701



PRAETORIAN AUTOCANNON LOADER 2
010508704



PRAETORIAN GUNNER TORSO 1
010506702

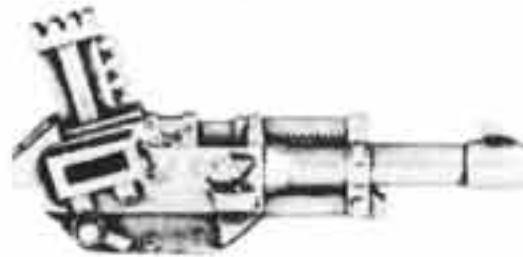

AUTOCANNON
010500512



HEAVY BOLTER
010504912



SHIELD
010504910



PRAETORIAN GUNNER TORSO 2
010506703



TRAIL
010504911

A COMPLETE PRAETORIAN HEAVY BOLTER CONSISTS OF:
1 x PRAETORIAN HEAVY BOLTER LOADER
1 x PRAETORIAN GUNNER BODY
1 x PRAETORIAN GUNNER LEGS
1 x SHIELD
1 x TRAIL
1 x HEAVY BOLTER
2 x WHEELS

A COMPLETE PRAETORIAN AUTOCANNON CONSISTS OF:
1 x PRAETORIAN AUTOCANNON LOADER
1 x PRAETORIAN GUNNER BODY
1 x PRAETORIAN GUNNER LEGS
1 x SHIELD
1 x TRAIL
1 x AUTOCANNON
2 x WHEELS



WHEEL
010504913



A COMPLETED PRAETORIAN HEAVY BOLTER

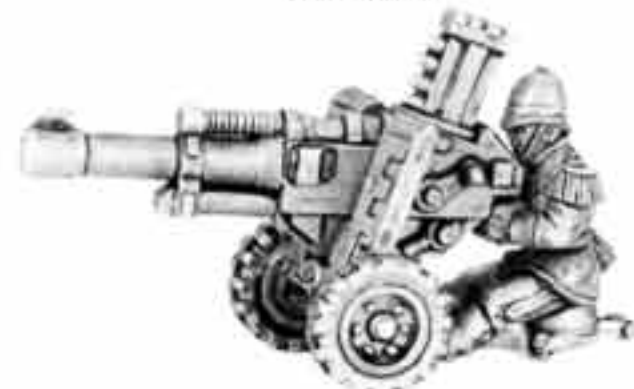

A COMPLETED PRAETORIAN AUTOCANNON

Designed by Michael Perry. Wheels designed by Norman Swales

Not recommended for children under 8 years due to small parts and essential pointed components. All models supplied unpainted.
© Copyright Games Workshop Ltd. 1998. All rights reserved.



IMPERIAL GUARD®

ROUGH RIDERS OF ATILA



**ROUGH RIDER
TORSO 1**
010504401



**ROUGH RIDER
TORSO 2**
010504402



**ROUGH RIDER
TORSO 3**
010504403



ROUGH RIDER'S LEGS 1
010504404



ROUGH RIDER'S LEGS 2
010504405



ROUGH RIDER HUNTING LANCE
010504406



**ROUGH RIDER
CHAINSWORD**
010504407



**ROUGH RIDER STANDARD
BEARER TORSO**
010500601

**A COMPLETE IMPERIAL GUARD
ROUGH RIDER CONSISTS OF:**
1 x ROUGH RIDER'S TORSO
1 x ROUGH RIDER'S LEGS
1 x WEAPON
1 x PLASTIC UNARMoured HORSE

**THE COMPLETE IMPERIAL GUARD
ROUGH RIDER STANDARD
BEARER CONSISTS OF:**
1 x ROUGH RIDER STANDARD
BEARER'S TORSO
1 x ROUGH RIDER'S LEGS
1 x PLASTIC UNARMoured HORSE



**IMPERIAL GUARD ROUGH RIDER
STANDARD BEARER**

ROUGH RIDERS OF ATILA LIEUTENNANT



**ROUGH RIDER
LIEUTENANT'S BODY**
010505201



**ROUGH RIDER
LIEUTENANT'S ARM**
010505202



ROUGH RIDER LIEUTENANT'S HUNTING LANCE
010505203

**A COMPLETE ROUGH RIDER OF ATILA
LIEUTENANT CONSISTS OF:**
1 x ROUGH RIDER LIEUTENANT'S BODY
1 x ROUGH RIDER LIEUTENANT'S ARM
1 x ROUGH RIDER LIEUTENANT'S HUNTING
LANCE
1 x PLASTIC UNARMoured HORSE



IMPERIAL GUARD ROUGH RIDER LIEUTENANT



IMPERIAL GUARD®

CAPTAIN CHENKOV OF VALHALLA

A COMPLETE CAPTAIN CHENKOV
CONSISTS OF:

- 1 x CAPTAIN CHENKOV'S BODY
- 1 x CAPTAIN CHENKOV'S CLOAK
- 1 x CAPTAIN CHENKOV'S BOLT PISTOL ARM
- 1 x CAPTAIN CHENKOV'S POWER SWORD ARM



CAPTAIN CHENKOV'S BODY
010501501



CAPTAIN CHENKOV'S
CLOAK
010501502



CAPTAIN CHENKOV'S
BOLT PISTOL ARM
010501503



CAPTAIN CHENKOV'S
POWER SWORD ARM
010501504



CAPTAIN CHENKOV OF
VALHALLA

CAPTAIN AL' RAHEM OF TALLARN

A COMPLETE CAPTAIN AL' RAHEM
CONSISTS OF:

- 1 x CAPTAIN AL' RAHEM'S BODY
- 1 x CAPTAIN AL' RAHEM'S PLASMA
PISTOL ARM



CAPTAIN AL' RAHEM'S BODY
010501601



CAPTAIN AL' RAHEM'S
PLASMA PISTOL ARM
010501602



CAPTAIN
AL' RAHEM OF TALLARN

JUNGLE FIGHTER CAPTAIN



JUNGLE FIGHTER CAPTAIN'S
BODY
010501701

A COMPLETE
JUNGLE FIGHTER CAPTAIN
CONSISTS OF:

- 1 x JUNGLE FIGHTER
CAPTAIN'S BODY
- 1 x JUNGLE FIGHTER
CAPTAIN'S BOLTGUN ARM
- 1 x JUNGLE FIGHTER
CAPTAIN'S BACK PACK



JUNGLE FIGHTER
CAPTAIN'S BOLTGUN ARM
010501702



JUNGLE FIGHTER
CAPTAIN'S BACK PACK
010501703



JUNGLE FIGHTER CAPTAIN



IMPERIAL GUARD[®]

IMPERIAL GUARD COMMISSARS

A COMPLETE COMMISSAR 1
CONSISTS OF:
1 x COMMISSAR BODY 1
1 x COMMISSAR SWORD ARM 1



COMMISSAR BODY 1
010501906



COMMISSAR
SWORD ARM 1
010501907



COMMISSAR 1

A COMPLETE COMMISSAR 2
CONSISTS OF:
1 x COMMISSAR BODY 2
1 x COMMISSAR BOLTGUN ARM 2
1 x COMMISSAR SWORD ARM 2



COMMISSAR BODY 2
010501901



COMMISSAR
SWORD ARM 2
010501902



COMMISSAR
BOLTGUN ARM 2
010501903



COMMISSAR 2

A COMPLETE COMMISSAR 3
CONSISTS OF:
1 x COMMISSAR BODY 3
1 x COMMISSAR
HAND FLAMER ARM 3



COMMISSAR BODY 3
010501904



COMMISSAR
HAND FLAMER ARM 3
010501905



COMMISSAR 3



IMPERIAL GUARD®

RATLING SNIPERS



RATLING SNIPER 1
010501203



RATLING SNIPER 2
010501205



RATLING SNIPER 3
010501202



RATLING SNIPER 4
010501204



RATLING SNIPER 5
010501206



RATLING SNIPER 6
010501201

Designed by Alan Perry

COMMISSAR YARRICK

THE COMPLETE COMMISSAR
YARRICK
CONSISTS OF:
1 x COMMISSAR YARRICK'S
BODY
1 x COMMISSAR YARRICK'S
BANNER POLE



COMMISSAR YARRICK'S
BODY
010504501



COMMISSAR YARRICK'S
BANNER POLE
010504502



COMMISSAR YARRICK



Designed by Jes Goodwin

Not suitable for children under 8 years due to small parts and essential pointed components. All models supplied unpainted.
© Copyright Games Workshop Ltd. 1998. All rights reserved.

IMPERIAL GUARD[®]

OGRYNS



OGRYN HEAD 2
010504301



OGRYN HEAD 3
010504302



OGRYN HEAD 1
010504303



OGRYN BODY 1
010504306



OGRYN BODY 2
010504307



OGRYN BODY 3
010504310



OGRYN GUN 2
010504308



OGRYN GUN 1
010504309



OGRYN GUN 3
010504311



OGRYN LEGS 1
010504304



OGRYN LEGS 2
010504305

A COMPLETED OGRYN
CONSISTS OF:
1 x OGRYN HEAD
1 x OGRYN BODY
1 x OGRYN GUN
1 x OGRYN LEGS
PLEASE NOTE BODY 3
WILL ONLY FIT WITH GUN 3



OGRYNS



IMPERIAL GUARD

SENTINEL

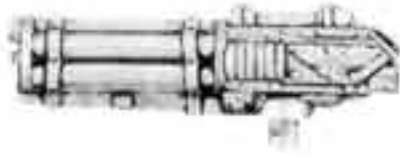

ASSAULT CANNON
010509005



ENGINE
010509003



FOOT
010509008



PILOT
010509004

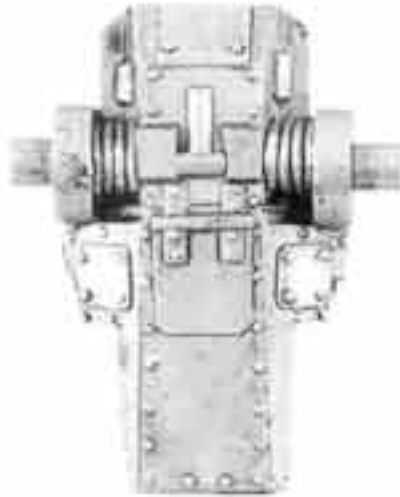

BODY BOTTOM
010509002



LEFT LEG
010509006



RIGHT LEG
010509007



BODY TOP
010509001

A COMPLETE SENTINEL CONSISTS OF:

- 1 X ASSAULT CANNON
- 1 X ENGINE
- 2 X FOOT
- 1 X PILOT
- 1 X RIGHT LEG
- 1 X LEFT LEG
- 1 X LOWER CHASSIS
- 1 X UPPER CHASSIS

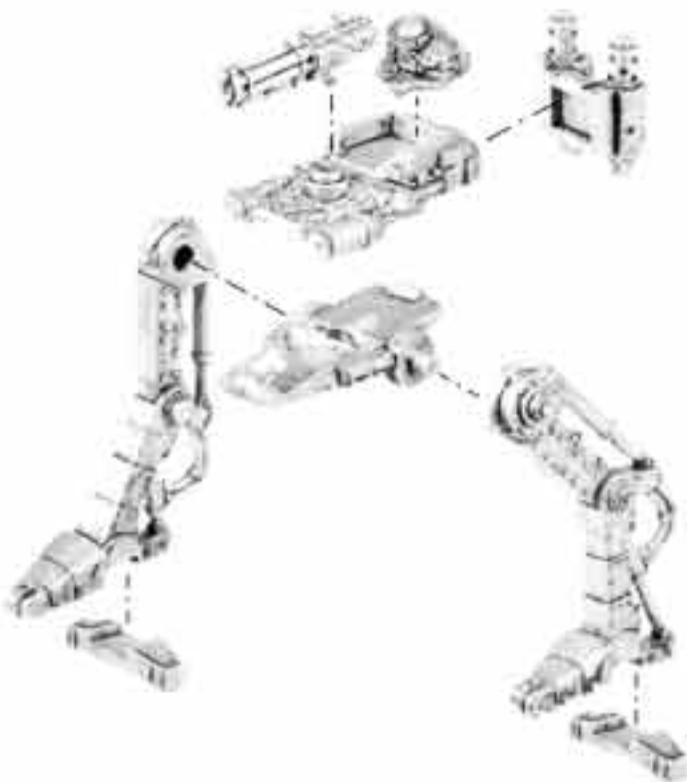

SENTINEL



CITADEL
MINIATURES



CITADEL
MINIATURES

Designed by Norman Swales and Michael Perry

Not recommended for children under 8 years due to small parts and essential pointed components. All models supplied unpainted.
© Copyright Games Workshop Ltd. 1998. All rights reserved.

IMPERIAL GUARD

IMPERIAL LEMAN RUSS DEMOLISHER



LEMAN RUSS DEMOLISHER IMPERIAL SIEGE TANK

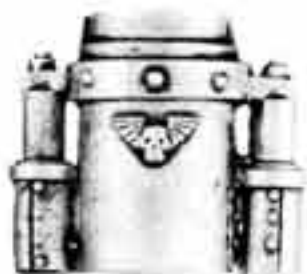

DEMOLISHER CANNON TOP
010505307



DEMOLISHER CANNON BOTTOM
010505308



DEMOLISHER CANNON MANTLET
010505306



HEAVY PLASMA GUN
010505311



SPONSON REAR
010505310



MULTI MELTA
010505312



SPONSON FRONT
010505309



HATCH BASE
010505302



IMPERIAL GUARD TANK COMMANDER
010505301



CUPOLA
010505303



HATCH 1
010505304



HATCH 2
010505305

- A COMPLETE LEMAN RUSS DEMOLISHER IMPERIALSIEGE TANK CONSISTS OF:**
- 1 x LEMAN RUSS IMPERIAL BATTLE TANK PLASTIC SPRUE FRAME B
 - 1 x LEMAN RUSS IMPERIAL BATTLE TANK PLASTIC SPRUE FRAME C
 - 1 x PLASTIC TRACK SPRUE FRAME T
 - 1 x PLASTIC WHEEL SPRUE FRAME W
 - 1 x PLASTIC ACCESSORY SPRUE FRAME A
 - 1 x IMPERIAL GUARD TANK COMMANDER
 - 1 x HATCH BASE
 - 1 x CUPOLA
 - 1 x HATCH 1
 - 1 x HATCH 2
 - 1 x DEMOLISHER CANNON TOP
 - 1 x DEMOLISHER CANNON BOTTOM
 - 1 x DEMOLISHER MANTLET
 - 2 x SPONSON FRONT
 - 2 x SPONSON REAR
 - 2 x HEAVY PLASMA GUN
 - 2 x MULTI-MELTA
 - 1 x TRANSFER SHEET
 - 1 x ADHESIVE COLOUR BANNER SHEET



IMPERIAL GUARD®

IMPERIAL BASILISK

- A COMPLETED IMPERIAL BASILISK
CONSISTS OF:
- 1 x IMPERIAL CHIMERA BODY PLASTIC
SPRUE FRAME B
 - 1 x IMPERIAL CHIMERA BODY PLASTIC
SPRUE FRAME C
 - 1 x PLASTIC TANK SPRUE FRAME T
 - 1 x PLASTIC WHEEL SPRUE FRAME W
 - 1 x PLASTIC ACCESSORY SPRUE
FRAME A
 - 1 x IMPERIAL BASILISK PLASTIC SPRUE
FRAME E
 - 1 x IMPERIAL BASILISK PLASTIC SPRUE
FRAME D

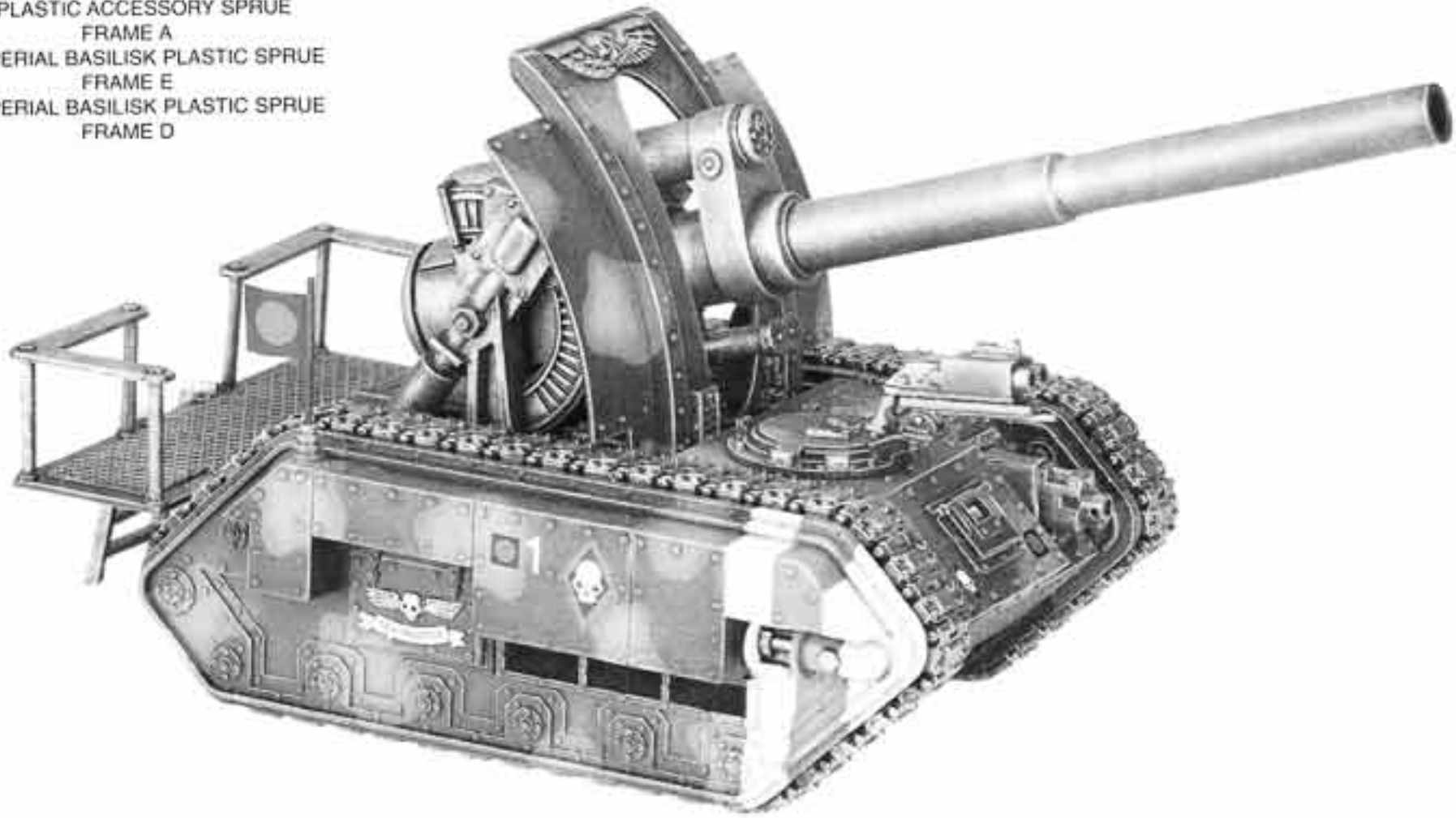

IMPERIAL BASILISK

IMPERIAL GUARD TANK ACCESSORIES



IMPERIAL TANK COMANDER
010512501



IMPERIAL TANK CREW 1
010512607



IMPERIAL TANK CREW 2
010512606



IMPERIAL TANK CREW 3
010512605



BASILISK TANK CREW 1
010512701



BASILISK TANK CREW 2
010512702



IMPERIAL TANK CREW
LASGUNS
010512502



IMPERIAL TANK
STOWAGE 1
010512503



IMPERIAL TANK
STOWAGE 2
010512504



IMPERIAL TANK
STOWAGE 3
010512608



IMPERIAL GUARD

IMPERIAL BASILISK

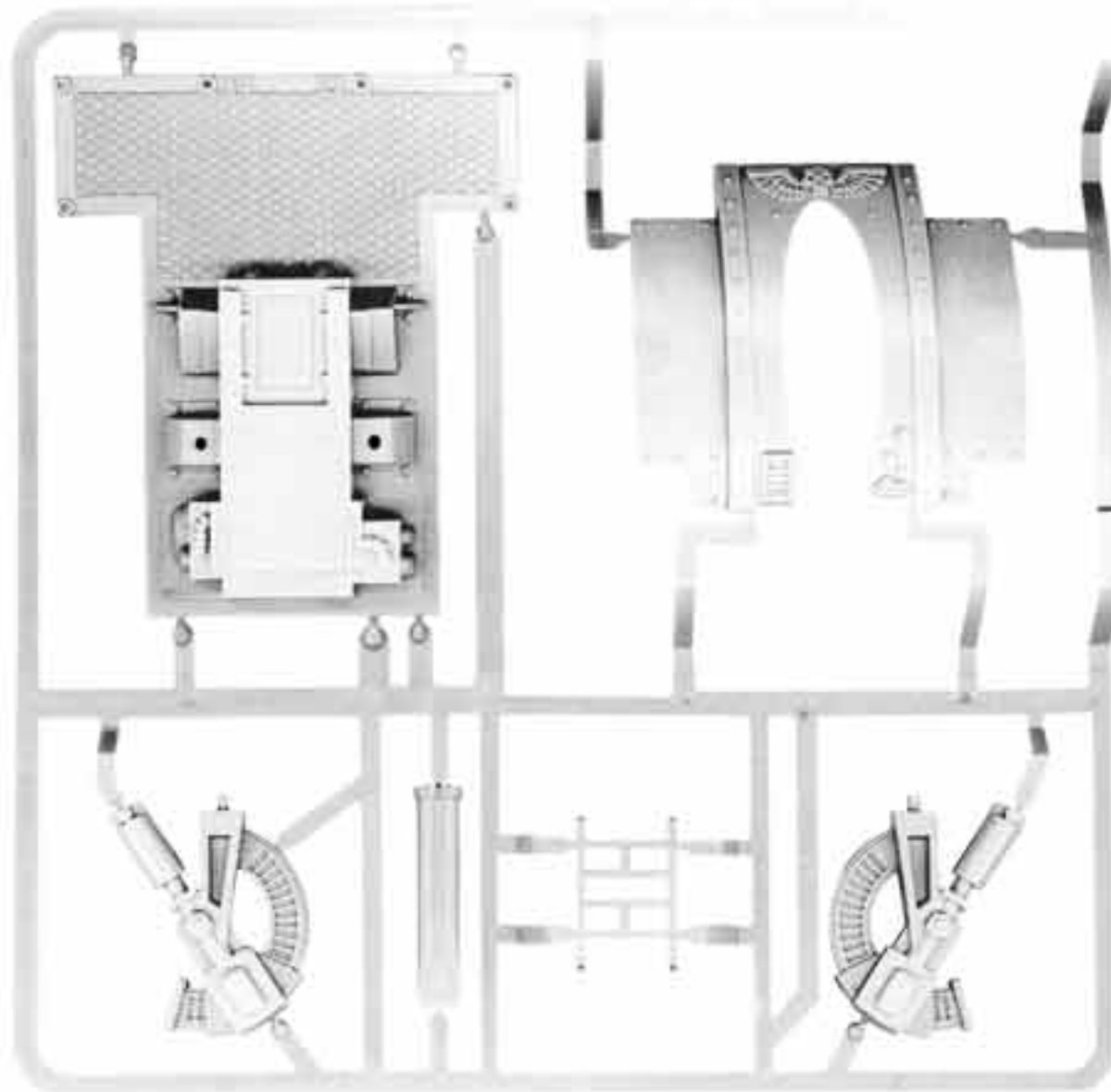

IMPERIAL BASILISK PLASTIC
SPRUE FRAME D
99399999044
SHOWN AT 55 % ACTUAL SIZE

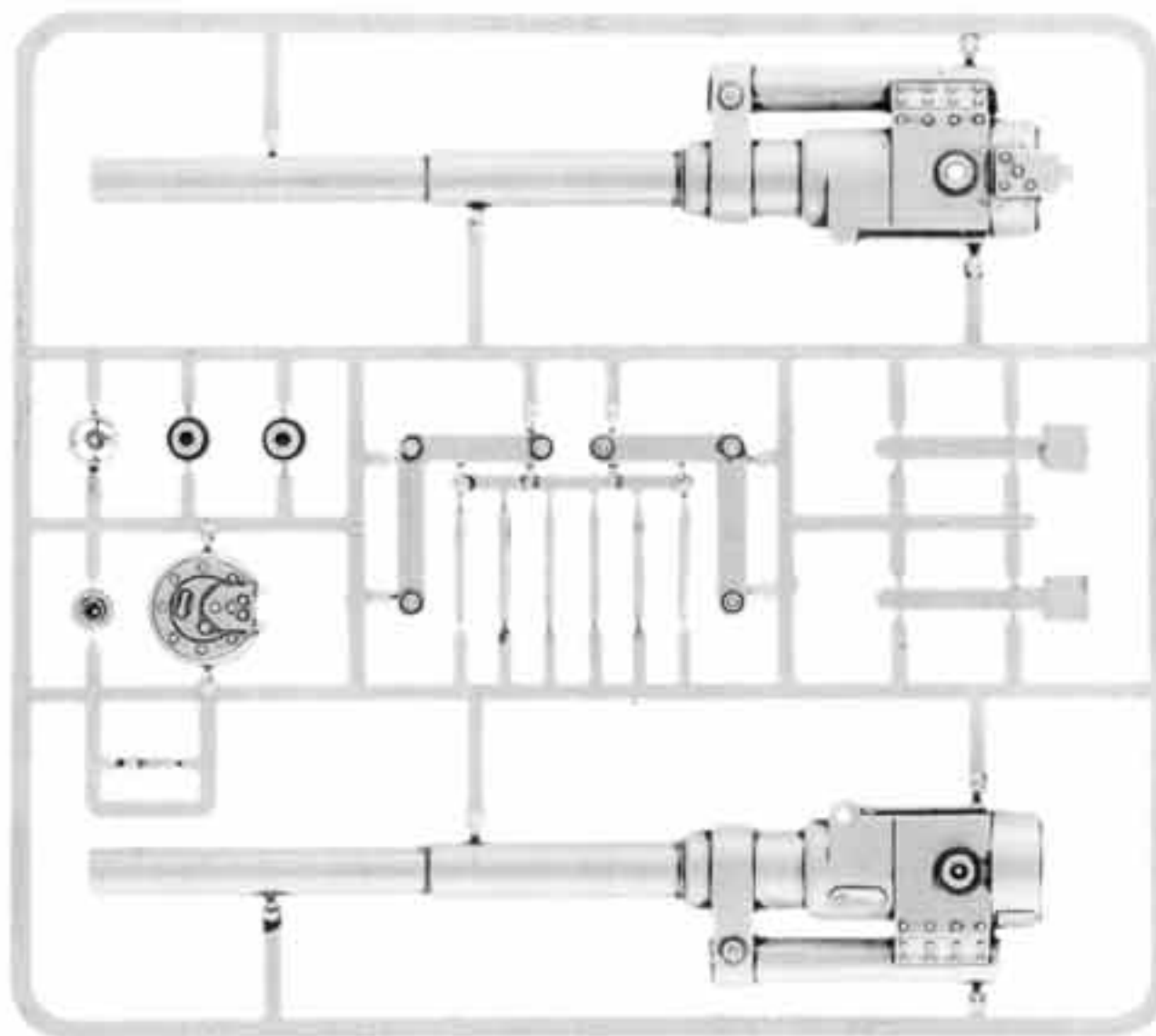

IMPERIAL BASILISK PLASTIC
SPRUE FRAME E
99399999045
SHOWN AT 60 % ACTUAL SIZE



CITADEL
MINIATURES



CITADEL
MINIATURES

IMPERIAL GUARD[®]

IMPERIAL HELLHOUND

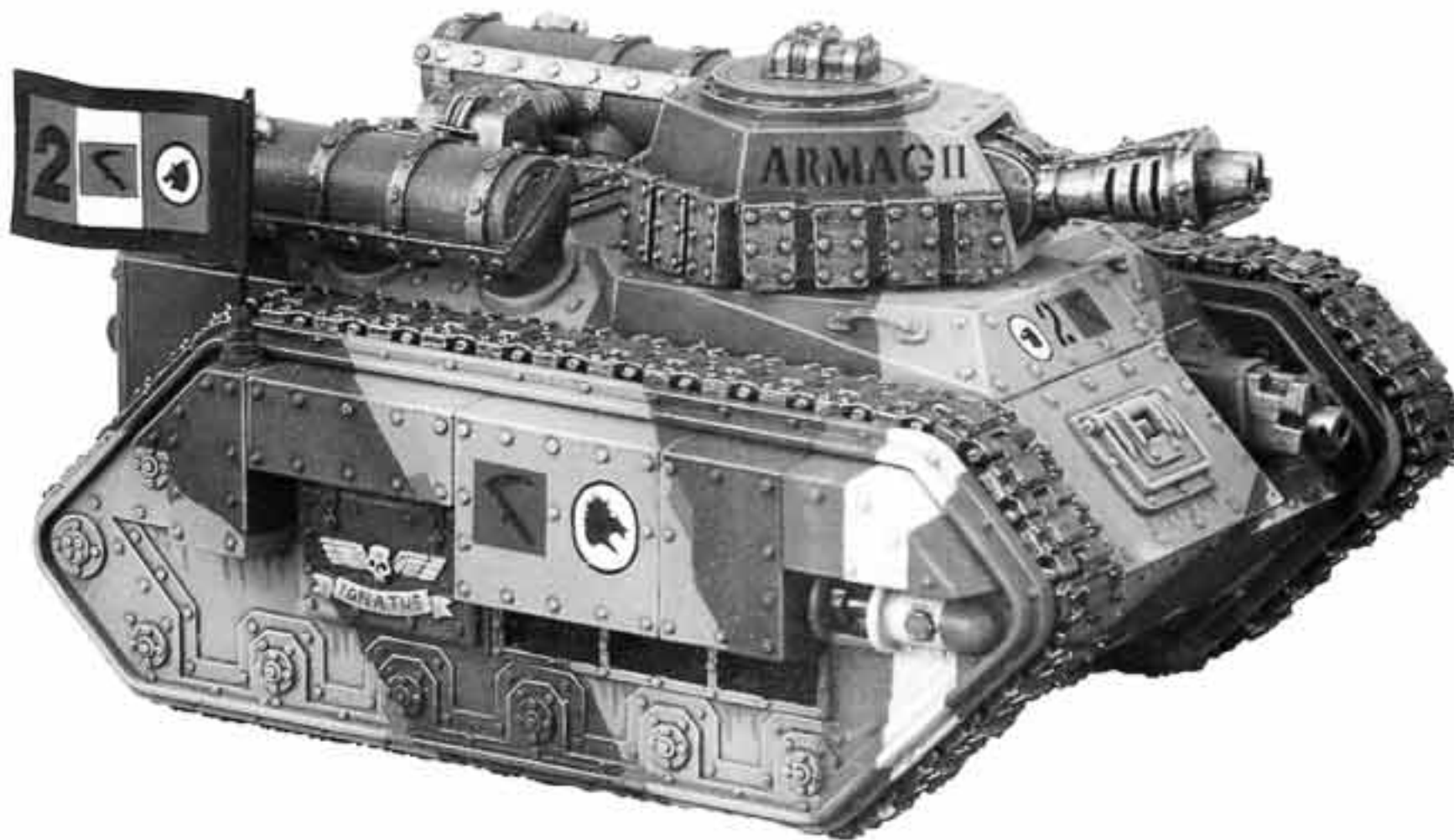

IMPERIAL HELLHOUND TANK

A COMPLETED IMPERIAL HELLHOUND

CONSISTS OF:

- 1 x IMPERIAL CHIMERA BODY PLASTIC SPRUE FRAME B
- 1 x IMPERIAL CHIMERA BODY PLASTIC SPRUE FRAME C
- 1 x IMPERIAL CHIMERA HULL PLASTIC SPRUE FRAME D
- 1 x IMPERIAL CHIMERA TURRET PLASTIC SPRUE FRAME E
- 1 x PLASTIC TRACK SPRUE FRAME T
- 1 x PLASTIC WHEEL SPRUE FRAME W
- 1 x PLASTIC ACCESSORY SPRUE FRAME A
- 1 x HELLHOUND TOP PLATE
- 2 x FUEL HOSE
- 2 x FUEL TANK BOTTOM
- 2 x FUEL TANK TOP
- 1 x TURRET BOTTOM
- 2 x SMALL TURRET ARMOUR PLATE
- 2 x LARGE TURRET ARMOUR PLATE
- 1 x TARGETING CUPOLA
- 1 x INFERNO CANNON
- 1 x ADHESIVE COLOUR BANNER SHEET
- 1 x TRANSFER SHEET



LARGE TURRET
ARMOUR PLATE
010505508



SMALL TURRET
ARMOUR PLATE
010505507



INFERNO CANNON
010505503



HELLHOUND FUEL
HOSE
010505509



TURRET BOTTOM
010505501



HELLHOUND TOP PLATE
010505502



FUEL TANK BOTTOM
010505505

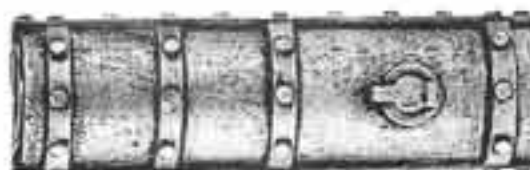

FUEL TANK TOP
010505506



TARGETING CUPOLA
010505504



Hellhound Components Designed by Norman Swales

IMPERIAL GUARD[®]

IMPERIAL GRIFFON



IMPERIAL GRIFFON

A COMPLETED IMPERIAL GRIFFON CONSISTS OF:

- 1 x CHIMERA BODY PLASTIC SPRUE FRAME B
- 1 x IMPERIAL CHIMERA BODY PLASTIC SPRUE FRAME C
- 1 x PLASTIC TRACK SPRUE FRAME T
- 1 x PLASTIC WHEEL SPRUE FRAME W
- 1 x PLASTIC ACCESSORY SPRUE FRAME A
- 1 x MORTAR BASE
- 1 x LEFT SIDE MORTAR SUPPORT PANEL
- 1 x RIGHT SIDE MORTAR SUPPORT PANEL
- 1 x RIGHT SIDE MORTAR BARREL
- 1 x LEFT SIDE MORTAR BARREL
- 1 x IMPERIAL GUARD MORTAR CREWMAN
- 1 x BACKPACK
- 1 x IMPERIAL GUARD GUNNER
- 1 x GRIFFON PLATFORM
- 1 x CUPOLA
- 1 x HATCH 1
- 1 x HATCH 2
- 1 x ADHESIVE COLOUR BANNER SHEET
- 1 x TRANSFER SHEET



CUPOLA
010505303



GRIFFON LEFT SIDE MORTAR SUPPORT PANEL
010505406

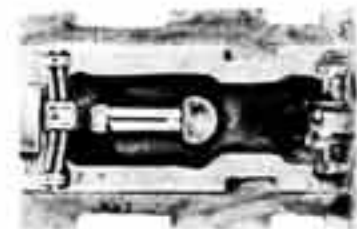

GRIFFON MORTAR BASE
010505405



HATCH 2
010505305



HATCH 1
010505304



GRIFFON RIGHT SIDE MORTAR SUPPORT PANEL
010505404



GRIFFON RIGHT SIDE MORTAR BARREL
010505403

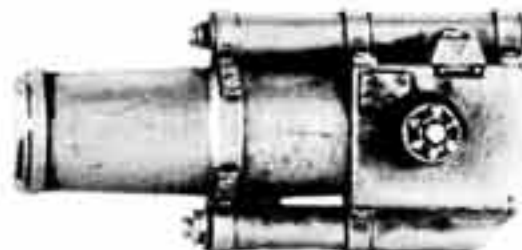

GRIFFON LEFT SIDE MORTAR BARREL
010505402

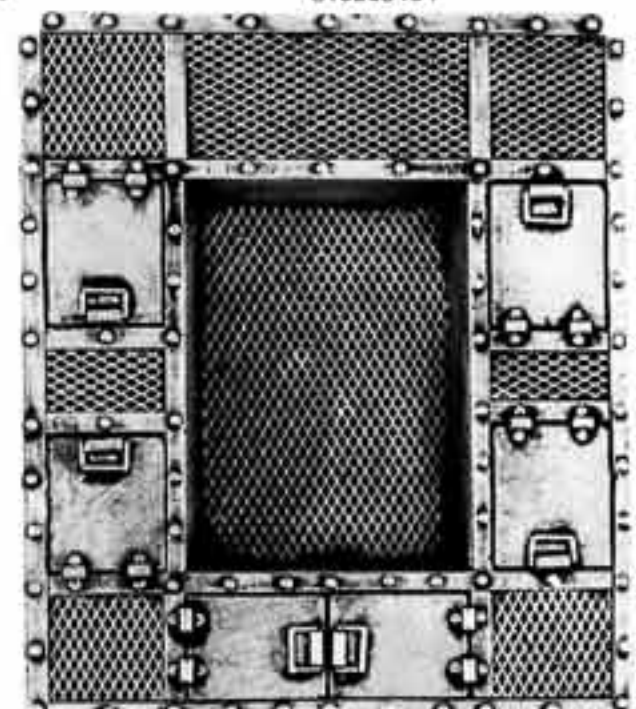

GRIFFON MORTAR PLATFORM
010505401



IMPERIAL GUARD MORTAR CREW
010505407



BACK PACK
010505408



IMPERIAL GUARD MORTAR GUNNER
010505409



IMPERIAL GUARD[®]

LEMAN RUSS IMPERIAL BATTLE TANK

THE LEMAN RUSS IMPERIAL BATTLE TANK IS A MULTI-PART PLASTIC KIT WHICH IS SUPPLIED AS 5 SEPARATE SPRUES TOGETHER WITH FULL COLOUR BANNERS AND TRANSFERS

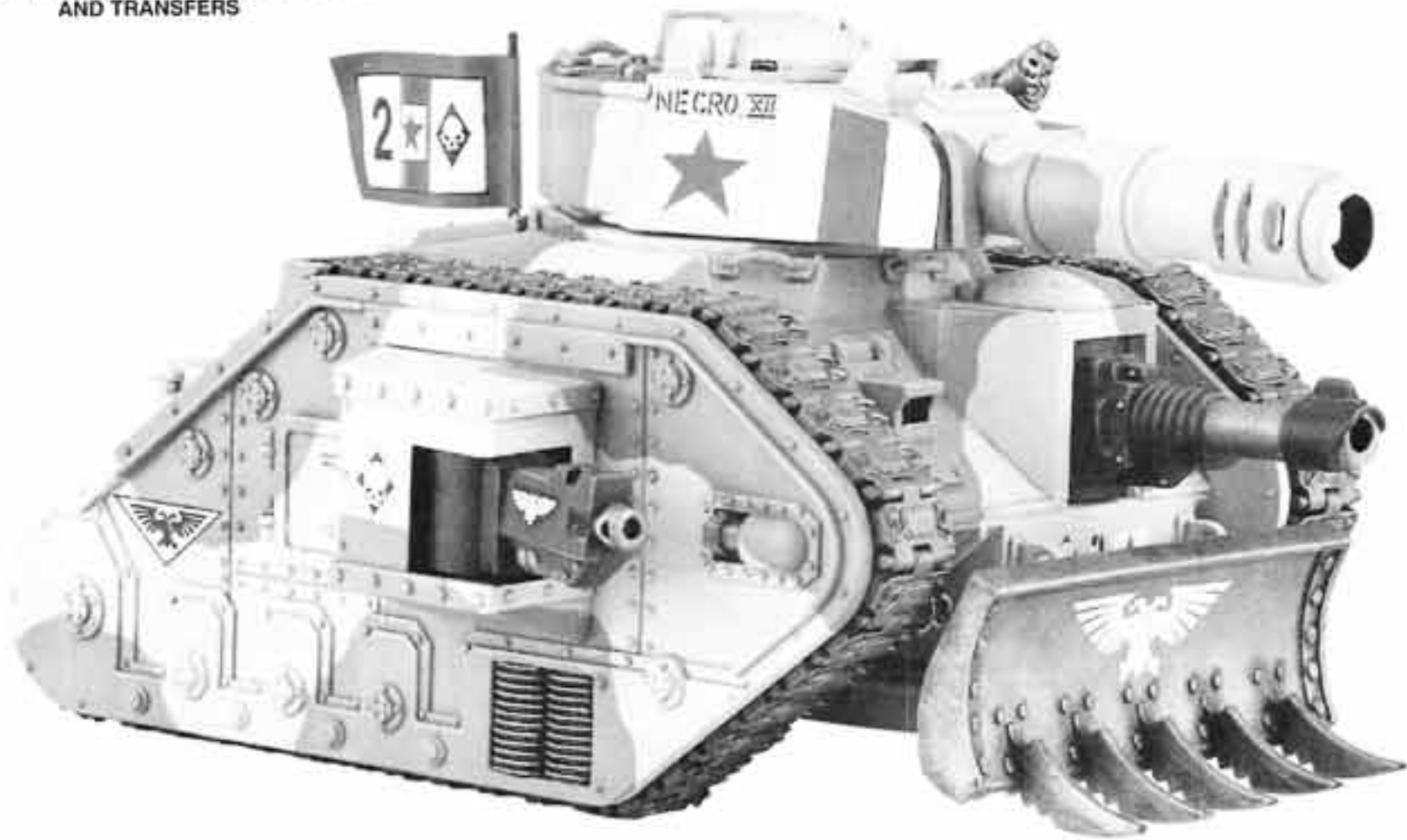

LEMAN RUSS IMPERIAL BATTLE TANK

IMPERIAL CHIMERA

THE IMPERIAL CHIMERA IS A MULTI-PART PLASTIC KIT WHICH IS SUPPLIED AS 7 SEPARATE SPRUES TOGETHER WITH FULL COLOUR BANNERS AND TRANSFERS

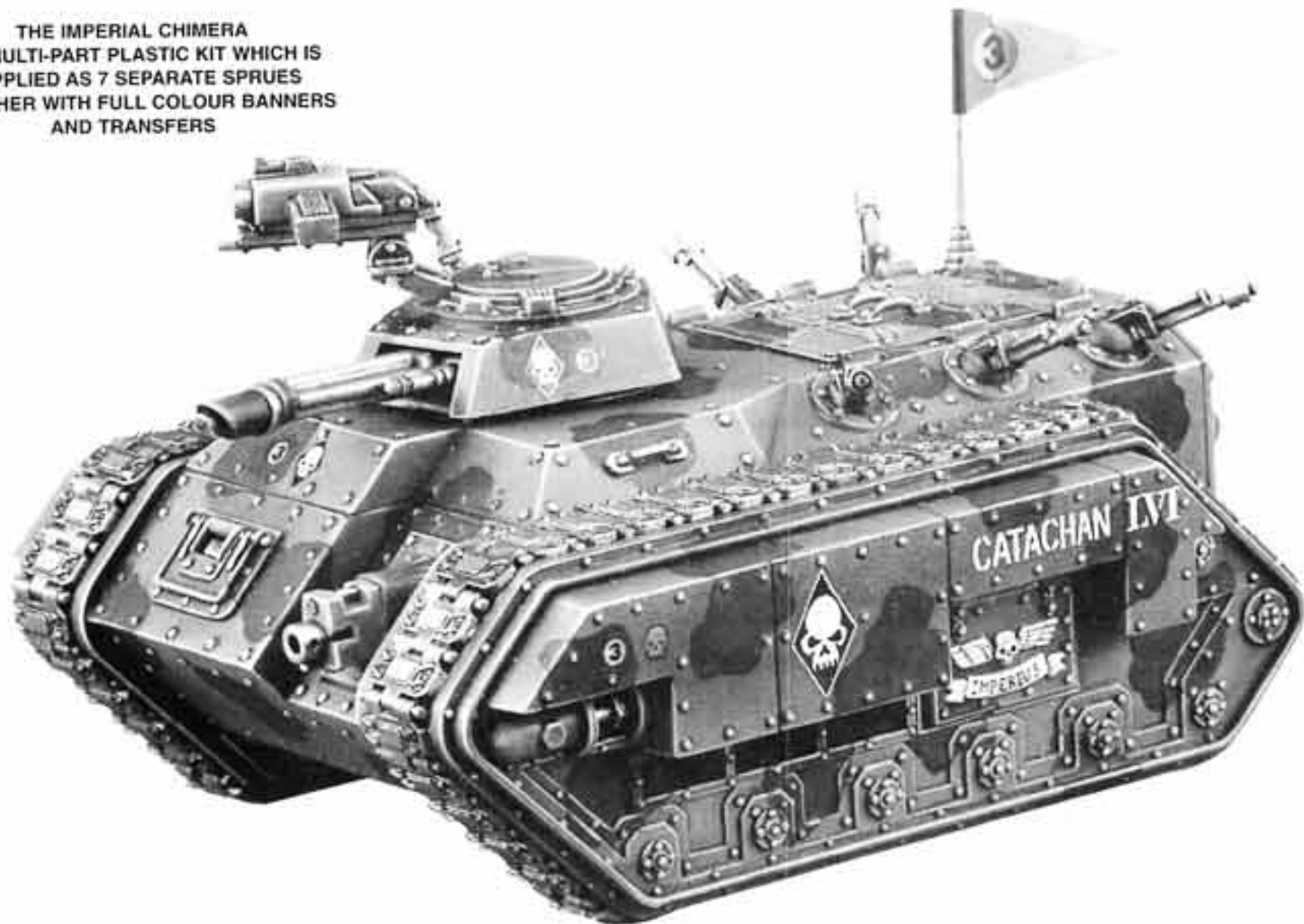

IMPERIAL CHIMERA

Designed by Micheal Perry

Not suitable for children under 8 years due to small parts and essential pointed components. All models supplied unpainted.
© Copyright Games Workshop Ltd. 1998. All rights reserved.



IMPERIAL GUARD[®]

LEMAN RUSS IMPERIAL BATTLE TANK

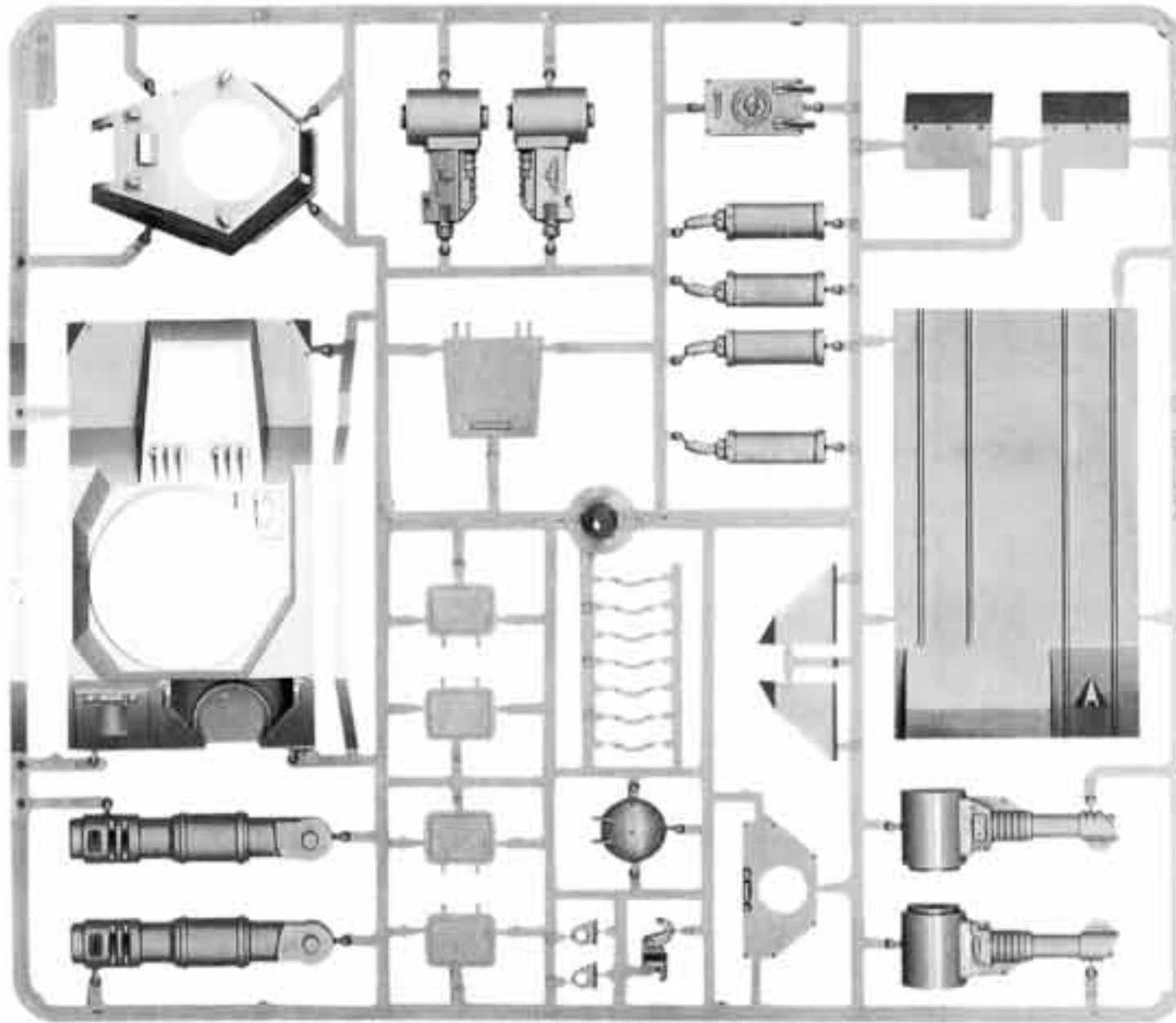

LEMAN RUSS PLASTIC SPRUE FRAME B
99399999042053
SHOWN AT 50% ACTUAL SIZE

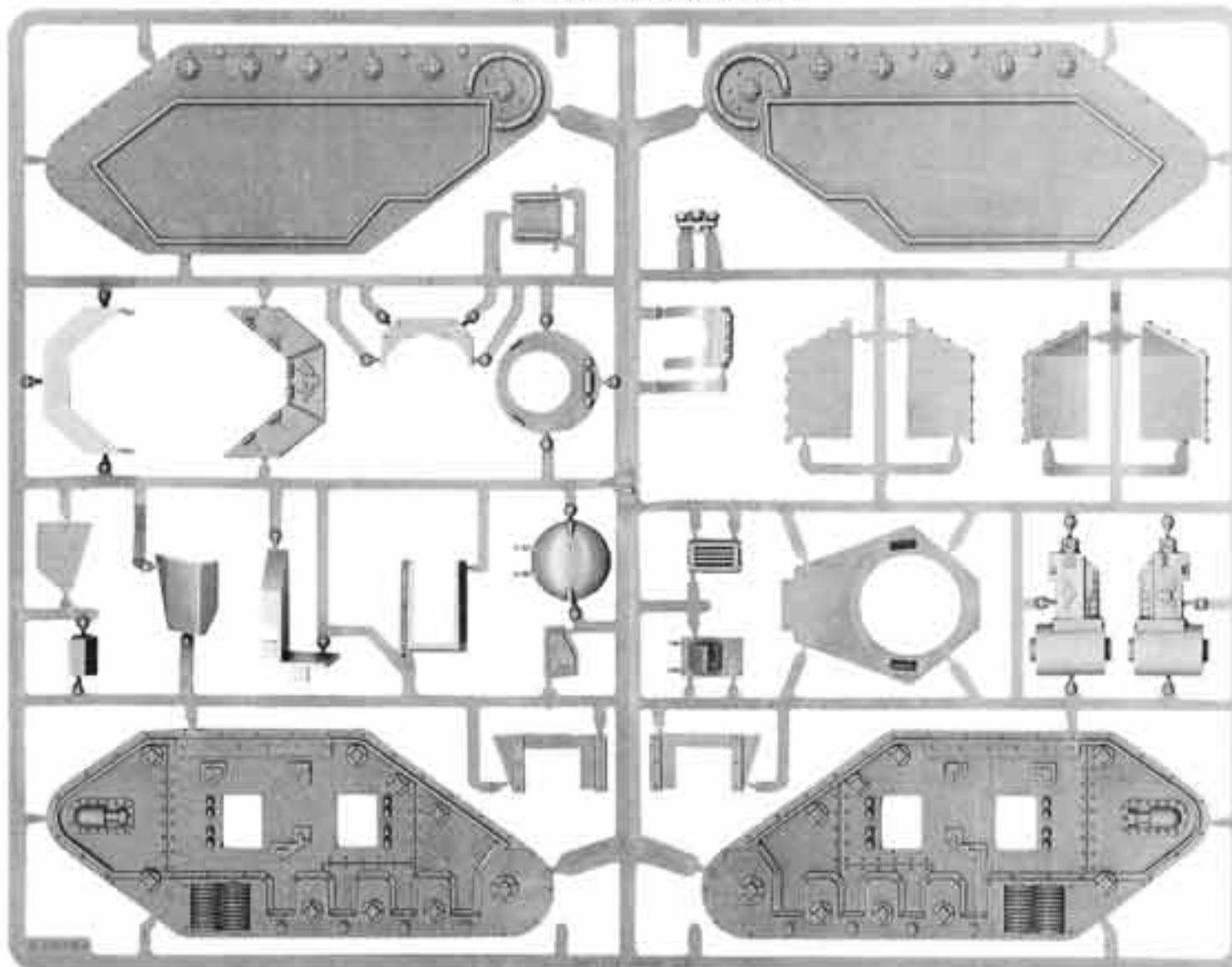

LEMAN RUSS PLASTIC SPRUE FRAME C
99399999042052
SHOWN AT 45% ACTUAL SIZE



IMPERIAL GUARD[®]

IMPERIAL CHIMERA

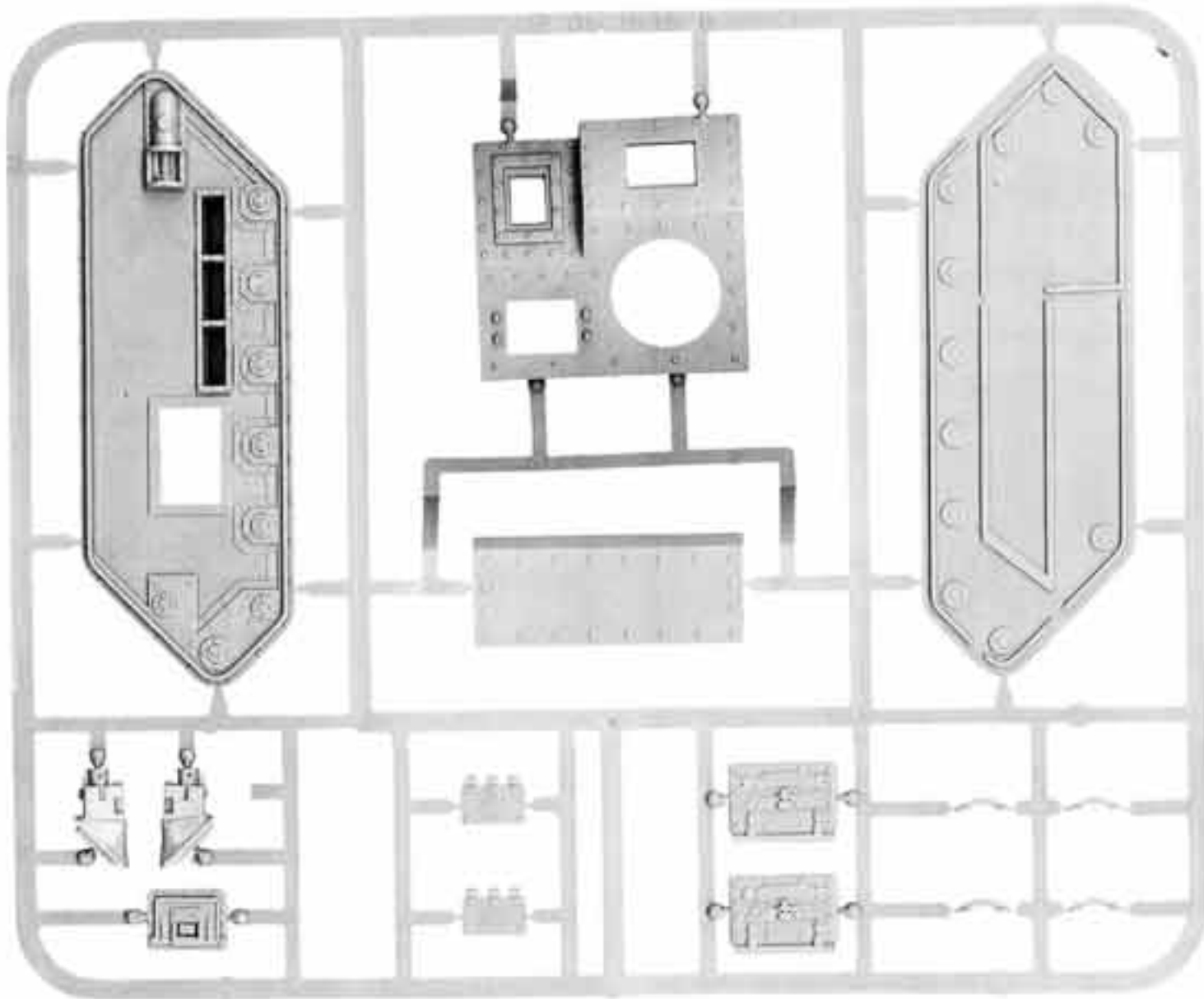

IMPERIAL CHIMERA PLASTIC SPRUE FRAME B
99399999042046
SHOWN AT 55% ACTUAL SIZE

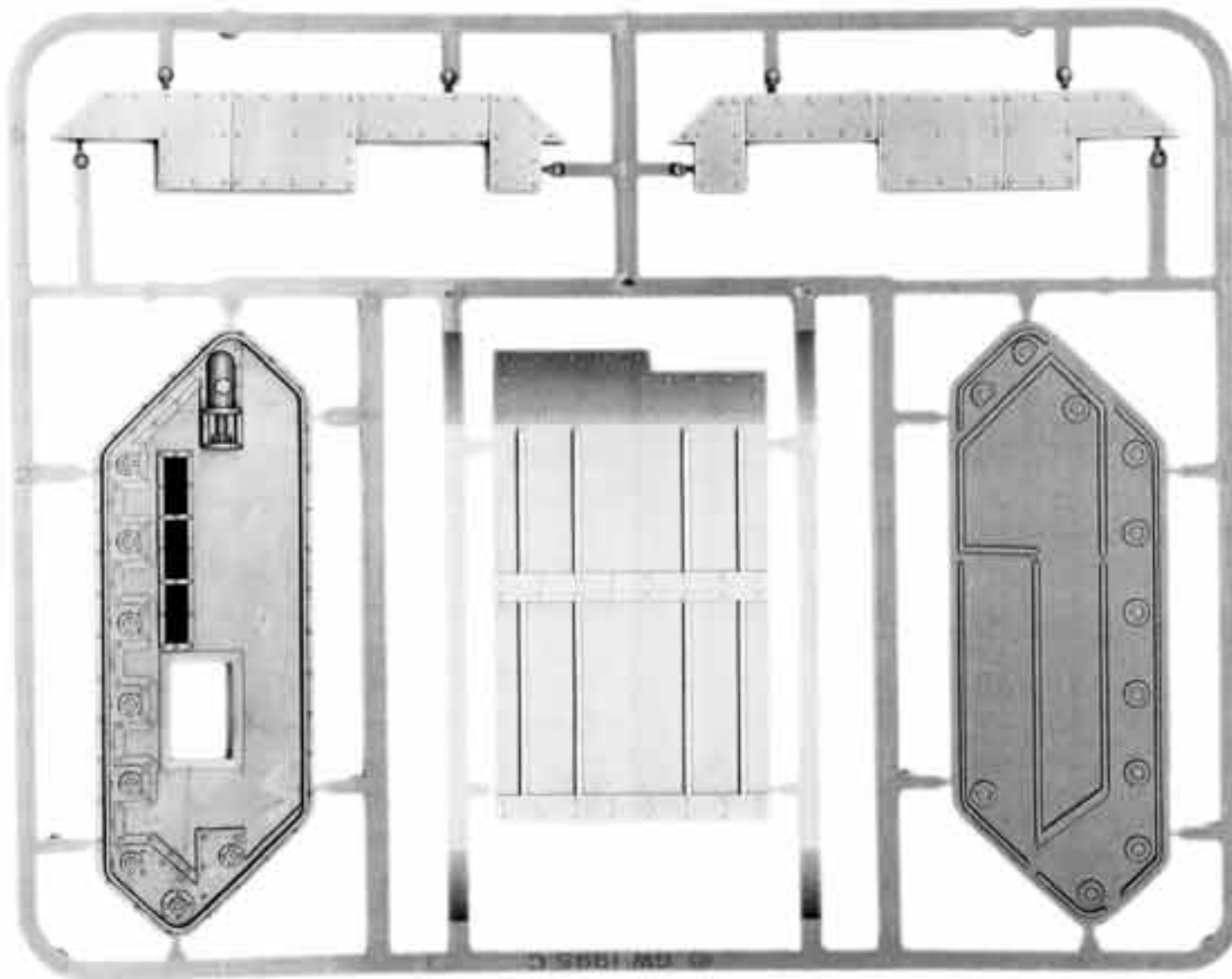

IMPERIAL CHIMERA PLASTIC SPRUE FRAME C
99399999042047
SHOWN AT 55% ACTUAL SIZE



Designed by Michael Perry

Not suitable for children under 8 years due to small parts and essential pointed components. All models supplied unpainted.
© Copyright Games Workshop Ltd. 1998. All rights reserved.

IMPERIAL GUARD[®]

IMPERIAL CHIMERA

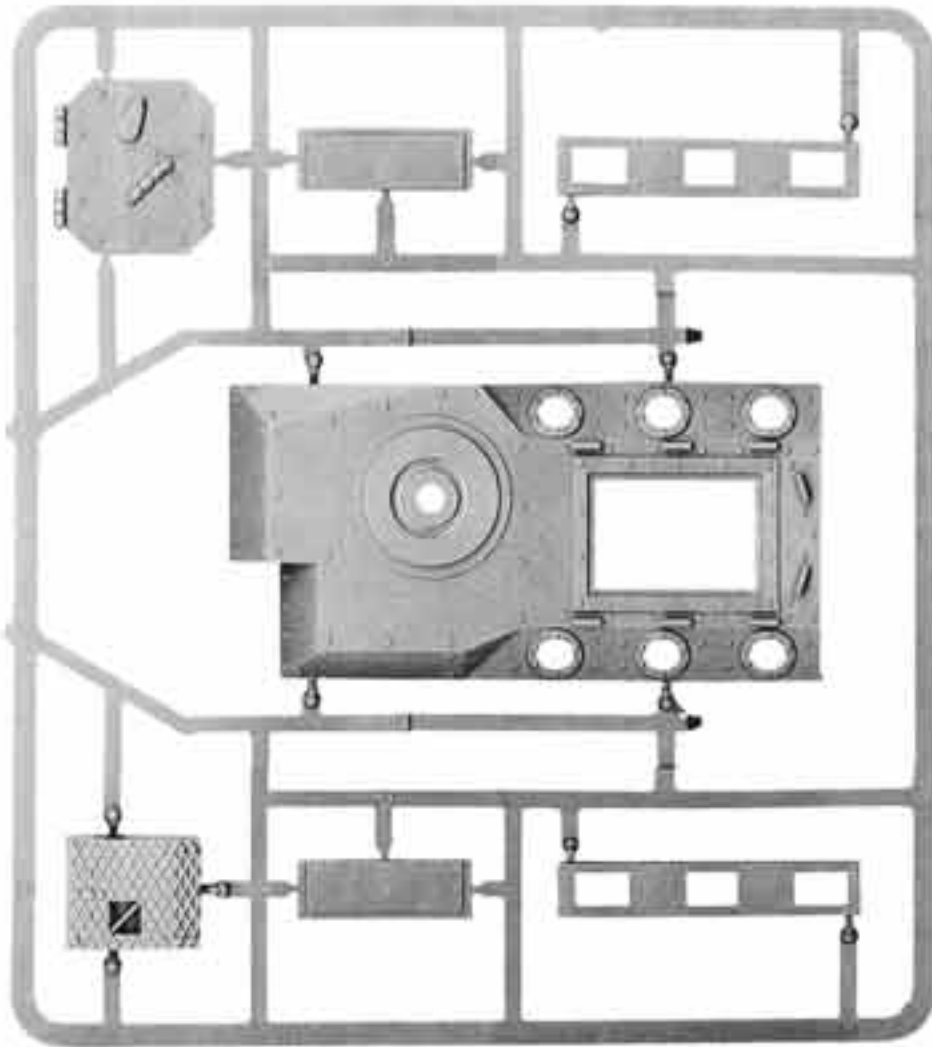

IMPERIAL CHIMERA PLASTIC SPRUE FRAME D
99399999042048
SHOWN AT 50% ACTUAL SIZE

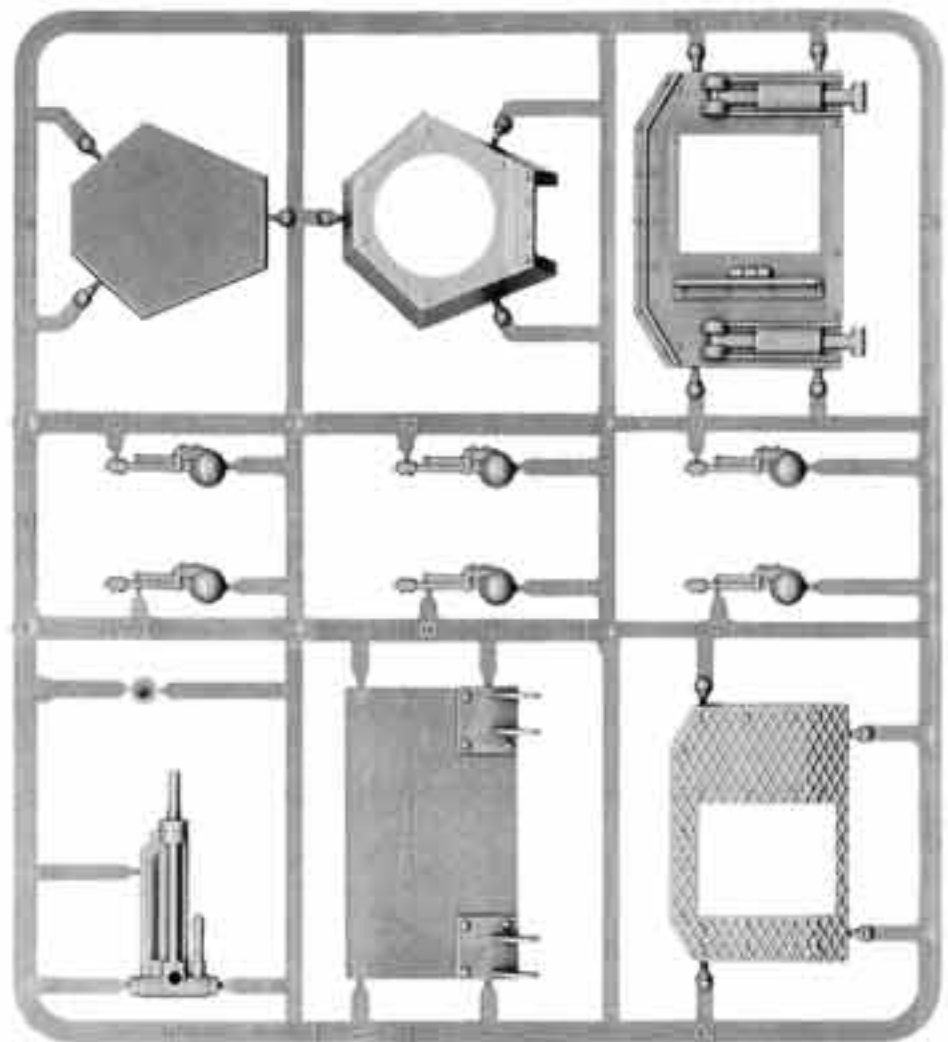

IMPERIAL CHIMERA PLASTIC SPRUE FRAME E
99399999042050
SHOWN AT 50% ACTUAL SIZE

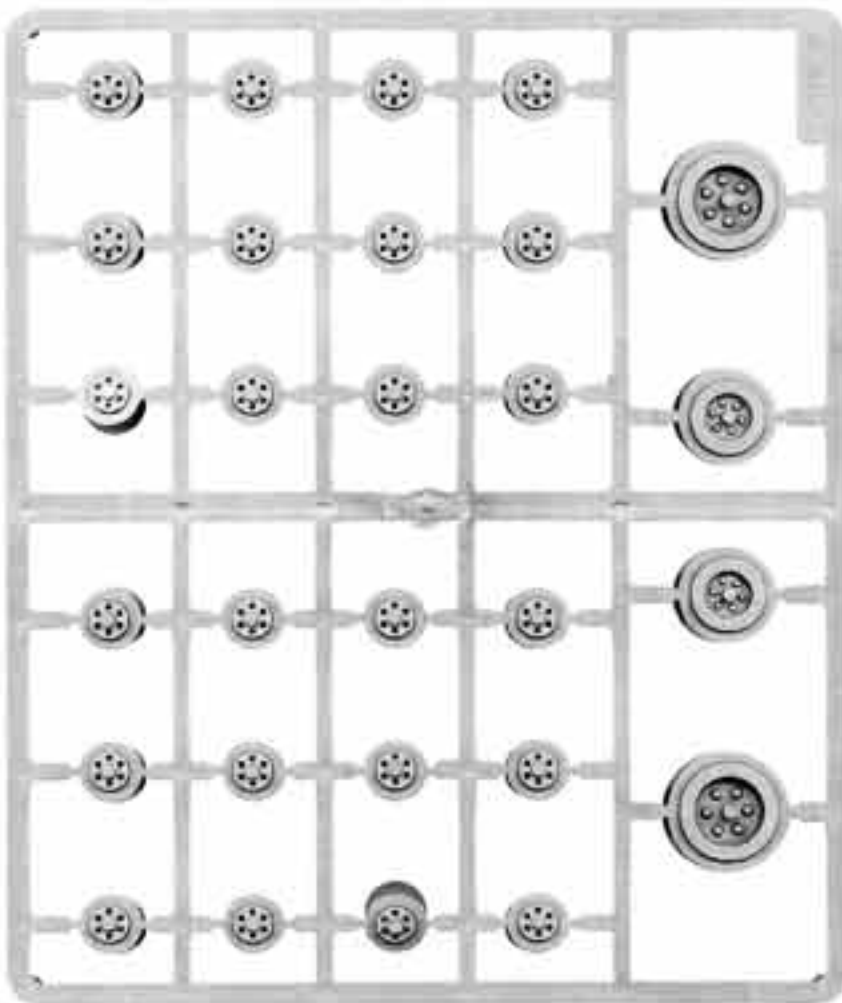

IMPERIAL TANK TRACK WHEELS SPRUE
99399999042043
SHOWN AT 50% ACTUAL SIZE

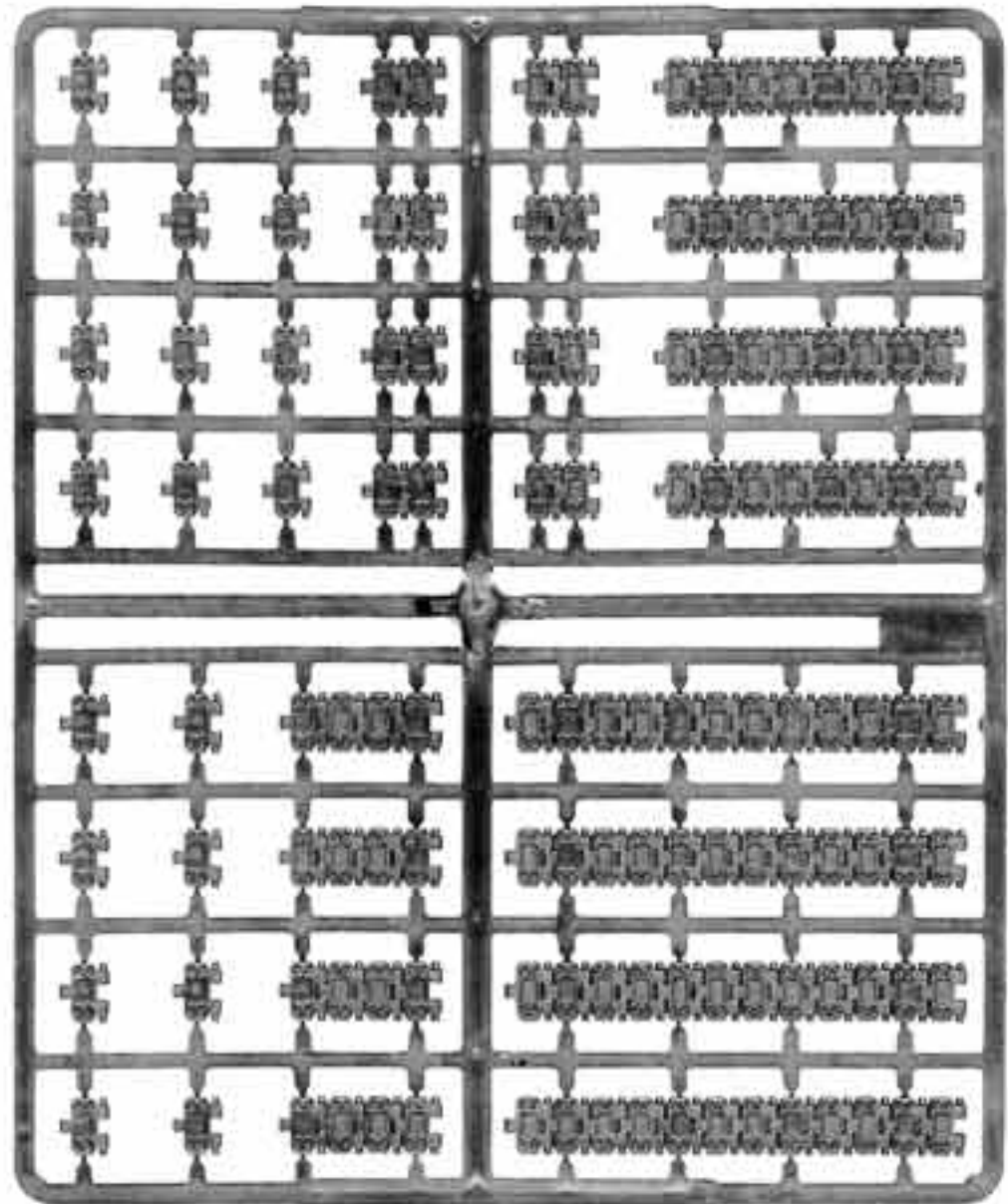

IMPERIAL TANK TRACK WHEELS SPRUE
99399999042042
SHOWN AT 50% ACTUAL SIZE



SPACE ORKS[®]

ORK SLUGGA BOYZ

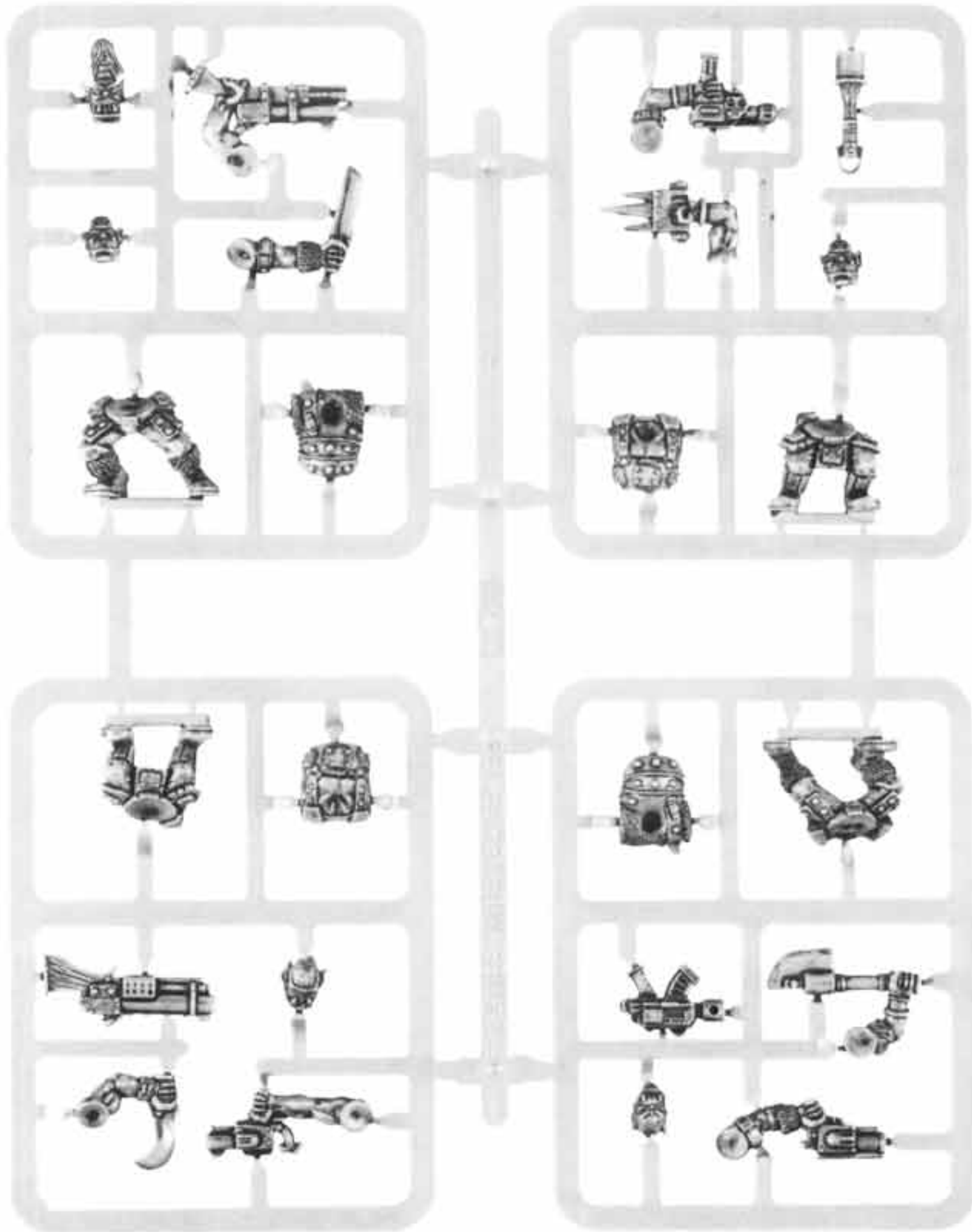

ORK SLUGGA BOYZ SPRUE (SHOWN AT 95% OF ACTUAL SIZE)
99380403001



Designed by Colin Dixon, Alan and Michael Perry

Not suitable for children under 8 years due to small parts and essential pointed components. All models supplied unpainted.
© Copyright Games Workshop Ltd. 1998. All rights reserved.

SPACE ORKS[®]

ORK WEAPONS



ORK HAND WEAPON SPRUE
040300801



ORK GUN SPRUE
040300802



GROT WEAPON SPRUE
040303103

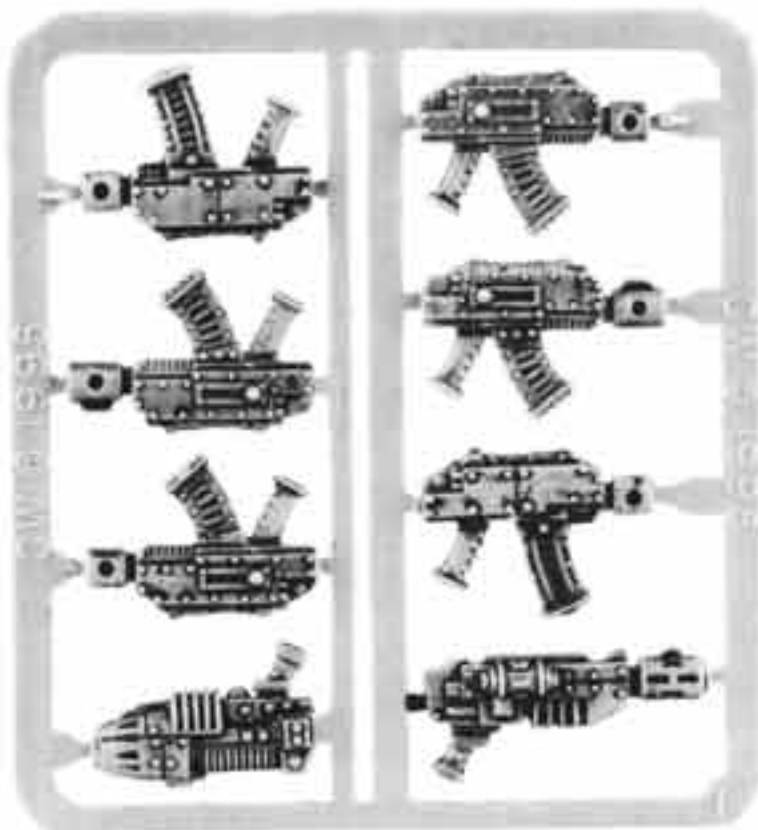

PLASTIC ORK BOLTA SPRUE
102732



PLASTIC ORK CLOSE COMBAT WEAPONS SPRUE
102783



SPACE ORKS®

GRETCHIN



GRETCHIN 1
040301201



GRETCHIN 2
040301202



GRETCHIN 3
040301203



GRETCHIN 4
040301204



GRETCHIN 5
040301205



GRETCHIN 6
040301206



GRETCHIN 7
040302803



GRETCHIN 8
040302802



GRETCHIN 9
040302801



GRETCHIN 10
040302804



GRETCHIN
BANNA WAVER
040302703



Designed by Colin Dixon and Brian Nelson

SPACE ORKS

MEKBOYZ



MEKBOY WITH WRENCH
040300501



MEKBOY WITH MALLET
040300502



MEKBOY BACKPACK 1
040300503



MEKBOY BACKPACK 2
040300504



MEKBOY RIGHT ARM
WITH SIX-SHOOTA
040300505



MEKBOY RIGHT ARM
WITH SLUGGA
040300506

A COMPLETE ORK MEKBOY
CONSISTS OF:
1 x MEKBOY
1 x MEKBOY RIGHT ARM
1 x MEKBOY BACKPACK



MEKBOYZ

SLAVER



SLAVER BODY
040301101



SLAVER GRABBA STIKK
040301102



SLAVER WHIP
040301103

A COMPLETE ORK SLAVER
CONSISTS OF:
1 x SLAVER BODY
1 x SLAVER GRABBA STIKK
1 x SLAVER WHIP



SLAVER

MAD DOK



MAD DOK BODY
040303001



MAD DOK HEAD
040303002



MAD DOK LEFT ARM
WITH SLUGGA
040303005



MAD DOK RIGHT ARM
WITH BONE SAW
040303004



MAD DOK BACK BANNER
040303003



MAD DOK

A COMPLETE ORK MAD DOK
CONSISTS OF:
1 x MAD DOK BODY
1 x MAD DOK HEAD
1 x MAD DOK LEFT ARM
1 x MAD DOK RIGHT ARM
1 x MAD DOK BACK BANNER

Slaver and Mekboyz designed by Brian Nelson, Mad Dok designed by Colin Dixon

SPACE ORKS[®]

NOBZ



NOB BODY 1
040300401



NOB BODY 2
040300402



NOB BODY 3
040300403



NOB RIGHT SLUGGA ARM 1
040300404



NOB RIGHT SLUGGA ARM 2
040300414



NOB RIGHT AXE ARM
040300405

A COMPLETE ORK NOB CONSISTS OF:

- 1 x NOB BODY
- 1 x NOB HEAD
- 1 x NOB RIGHT ARM
- 1 x NOB BACK BANNER, NOB AXE OR NOB SHOOTA



NOB BACK BANNER
040300408



NOB AXE
040300407



NOB SHOOTA
040300406



NOB HEAD 1
040300409



NOB HEAD 2
040300410



NOB HEAD 3
040300412



ORK NOB



Designed by Brian Nelson

Not suitable for children under 8 years due to small parts and essential pointed components. All models supplied unpainted.
© Copyright Games Workshop Ltd. 1998. All rights reserved.

SPACE ORKS[®]

ORK WARBIKE



A COMPLETED ORK WARBIKE

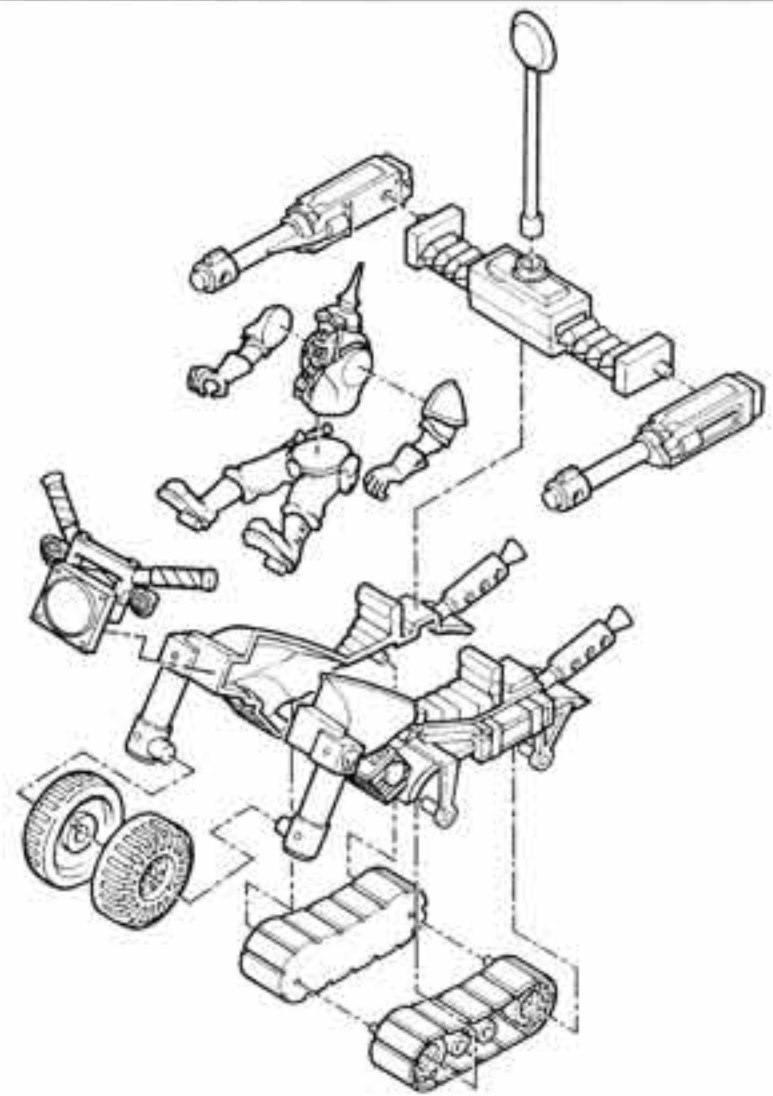

THE ORK WARBIKE MODEL KIT INCLUDES A CITADEL TRANSFER SHEET AND A COLOUR ADHESIVE BANNER

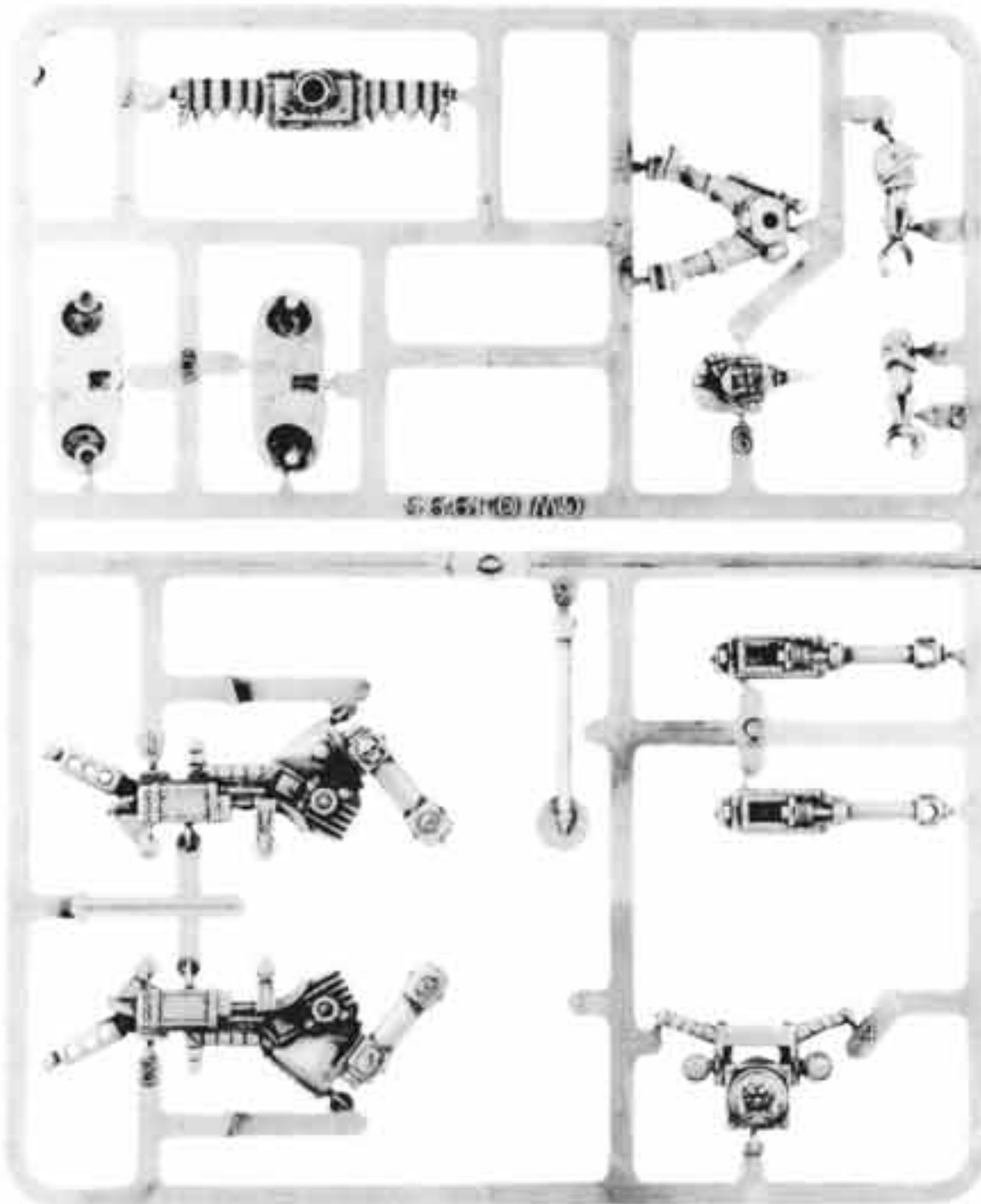

PLASTIC ORK WARBIKE SPRUE
(SHOWN AT 65% OF ACTUAL SIZE)
99399999039

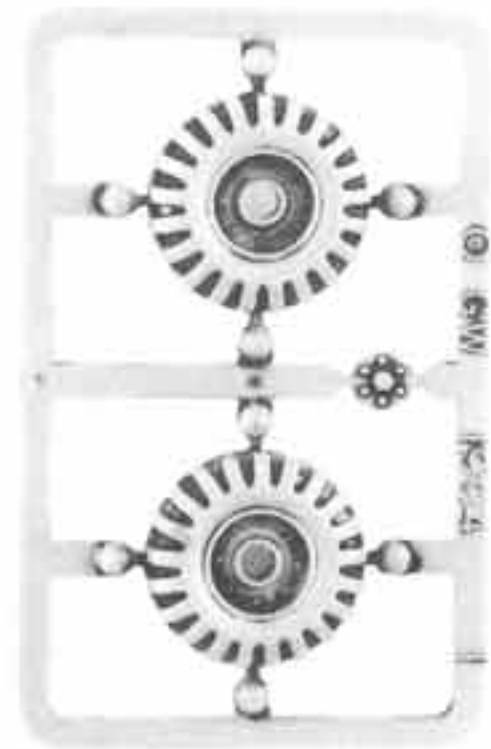

PLASTIC ORK WHEEL SPRUE
(SHOWN AT ACTUAL SIZE)
102791



Designed by Norman Swales and Alan Perry

SPACE ORKS[®]

SPACE ORK WAR BUGGY

A COMPLETE ORK WAR BUGGY
CONSISTS OF
1 x WAR BUGGY SPRUES
2 x ORK WHEEL SPRUES
2 x 40K LARGE TYRE



SPACE ORK WAR BUGGY

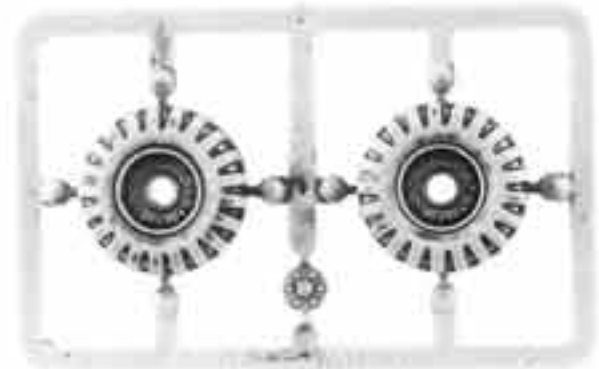

SPACE ORK WHEEL SPRUE
(SHOWN AT 75% OF ACTUAL SIZE
012791



LARGE TYRE SPRUE
(SHOWN AT 75% OF ACTUAL SIZE
012731

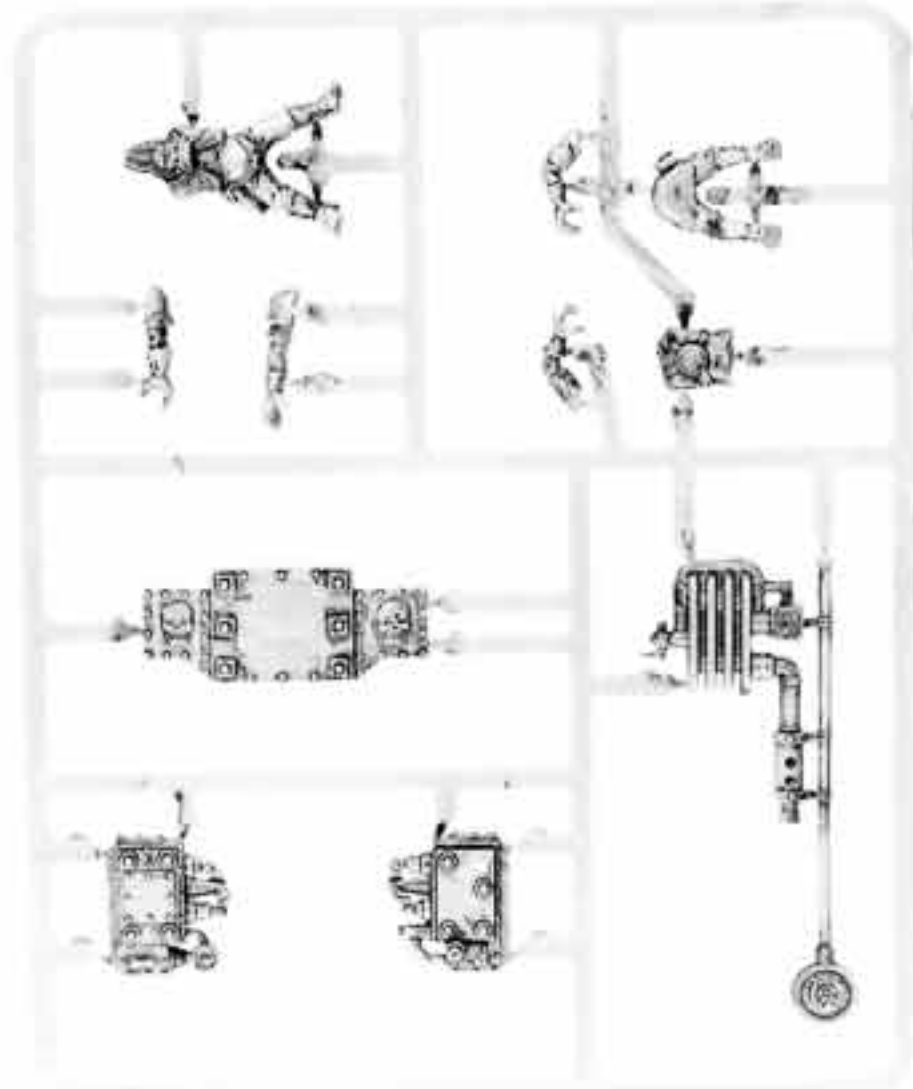
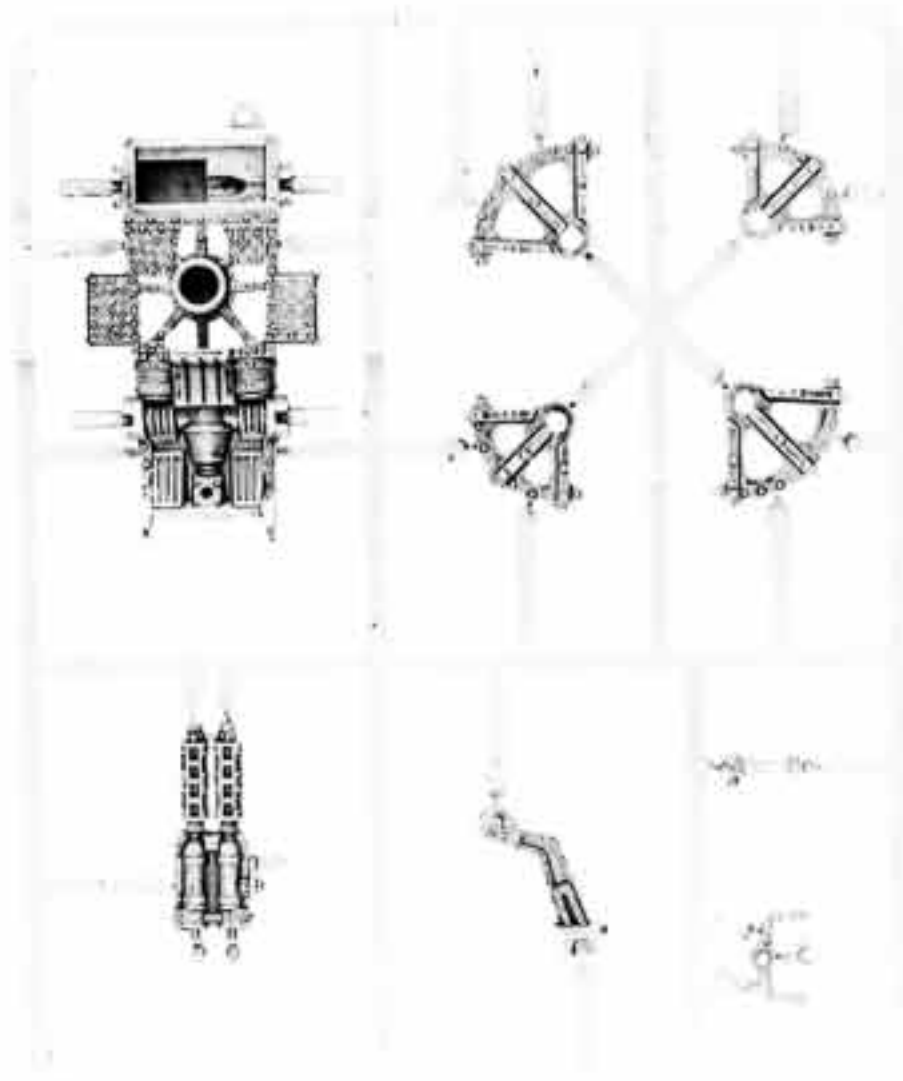

SPACE ORK PLASTIC WAR BUGGY SPRUES
(SHOWN AT 55% OF ACTUAL SIZE)
99399999040



Designed by Norman Swales and Alan Perry

SPACE ORKS[®]

ORK WAR TRUKK

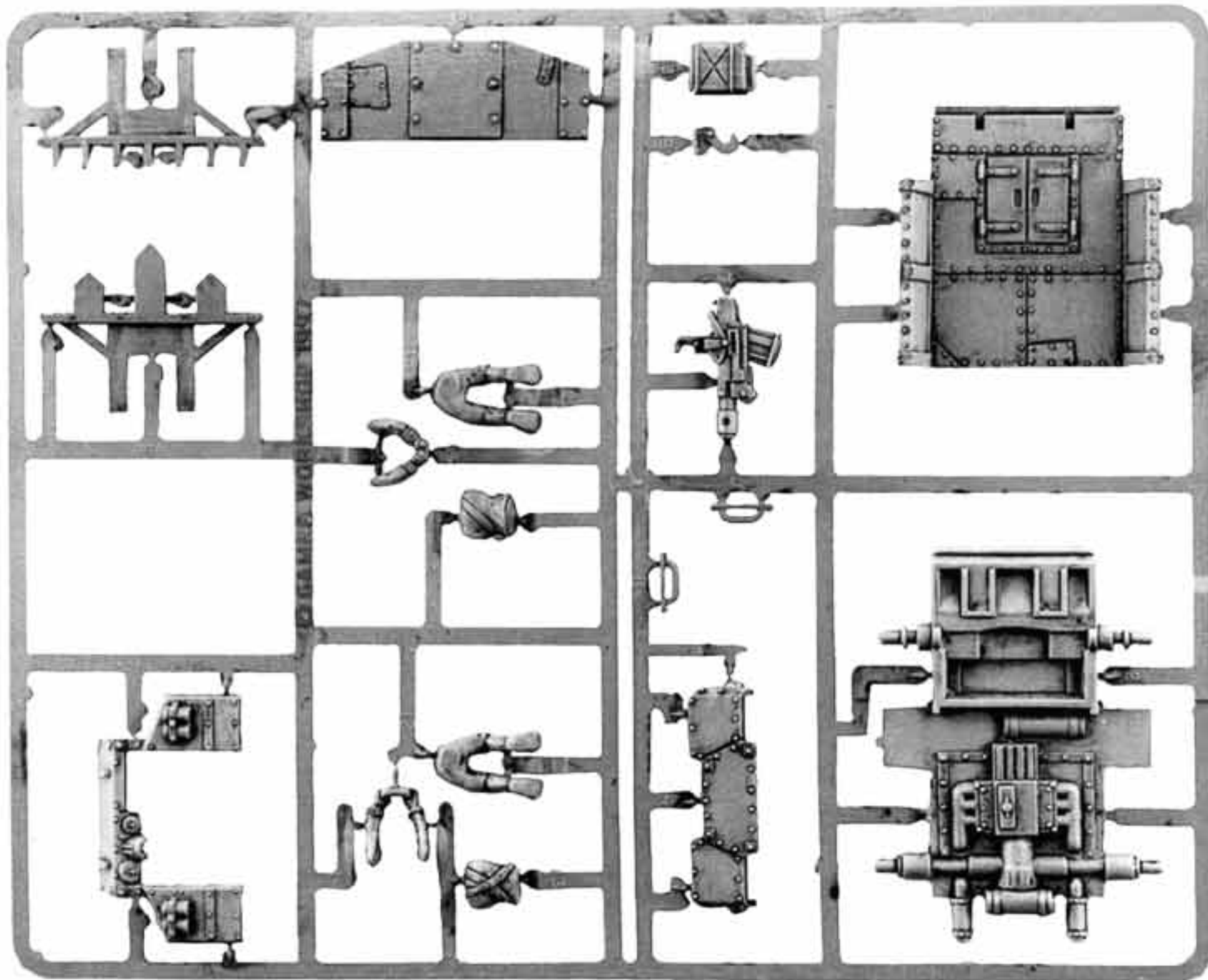

WAR TRUKK SPRUE (SHOWN AT 65% OF ACTUAL SIZE)
99390403002

A COMPLETE ORK WAR TRUKK

- CONSISTS OF:
1 x WAR TRUKK SPRUE
2 x ORK WHEEL SPRUE
2 x LARGE TYRE SPRUE



WAR TRUKK



ORK WHEEL SPRUE
(SHOWN AT 75% OF ACTUAL SIZE)
102791

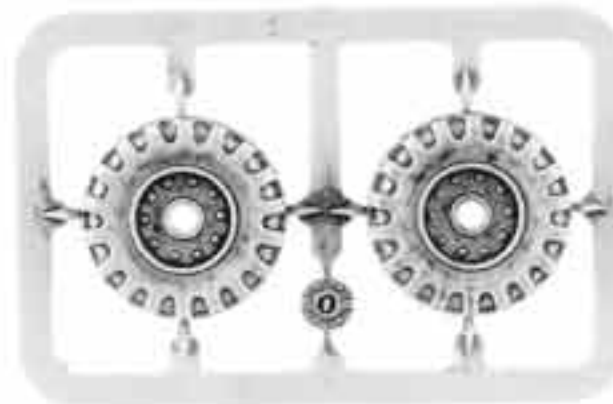

LARGE TYRE SPRUE
(SHOWN AT 75% OF ACTUAL SIZE)
1027937



SPACE ORKS[®]

ORK WAR TRAK

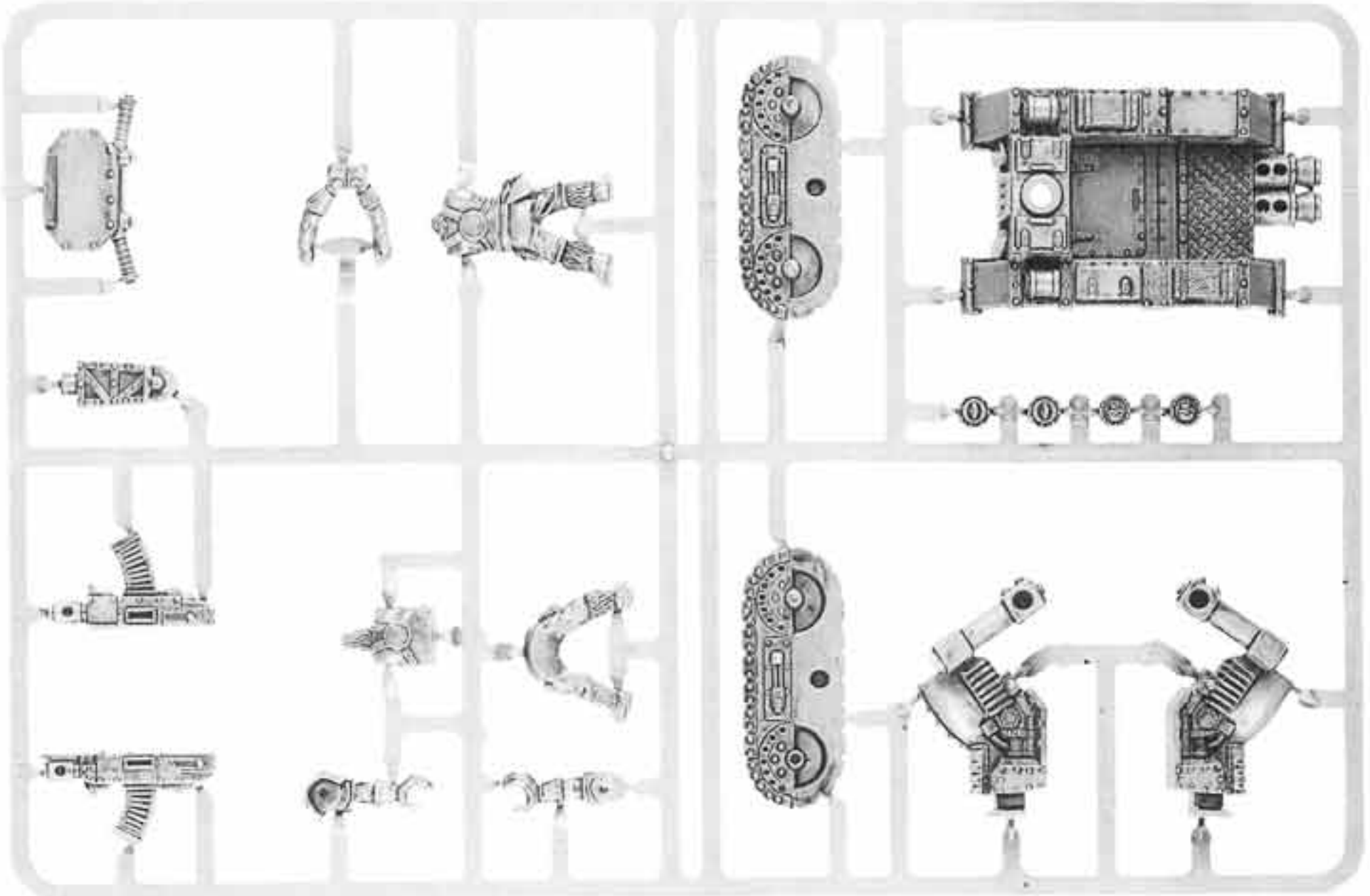

PLASTIC ORK WAR TRAK SPRUE
(SHOWN AT 70% OF ACTUAL SIZE)
9939043001

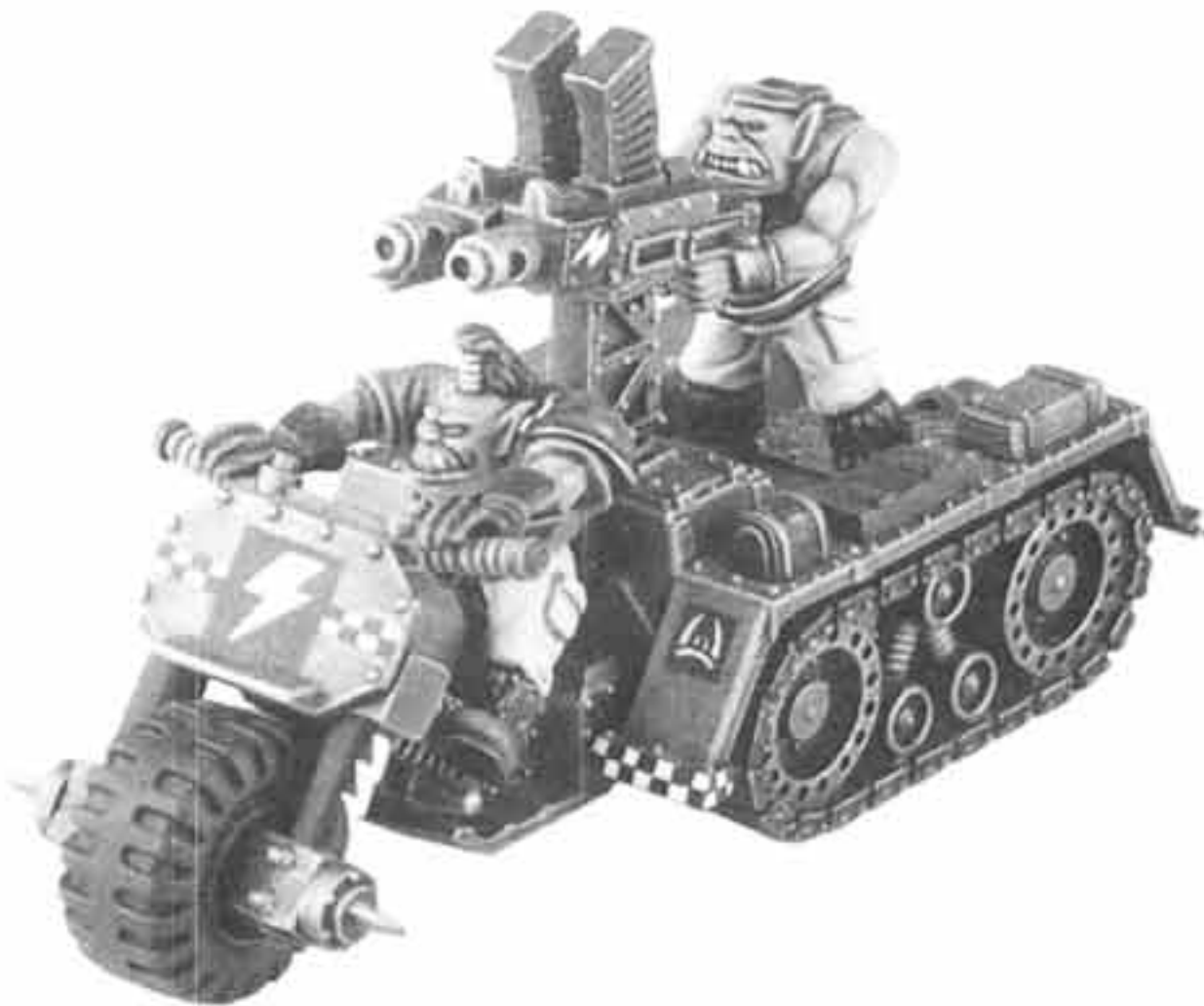

ORK WAR TRAK



SPACE ORKS®

SPACE ORK WARTRAK SCORCHA



WARTRAK SCORCHA
CUPOLA
010303101

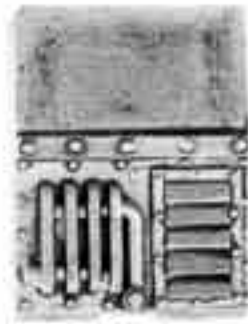

WARTRAK SCORCHA
BASE PLATE
010303102

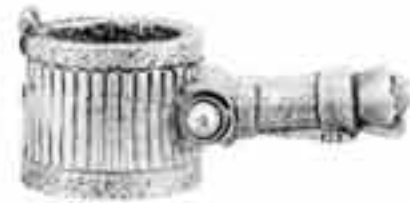

WARTRAK SCORCHA
SCORCHA
010303103



WARTRAK SCORCHA
TANK TOP
010303104



WARTRAK SCORCHA
TRAILER COUPLING
010303106



WARTRAK SCORCHA
TANK BOTTOM
010303105

WARTRAK SCORCHA
TAPS AND LEVERS SPRUE
010303107



WARTRAK SCORCHA
HATCH
010303108



WARTRAK SCORCHA
GAUGES
010303109



WARTRAK SCORCHA
SNOT PUMPER
010303110

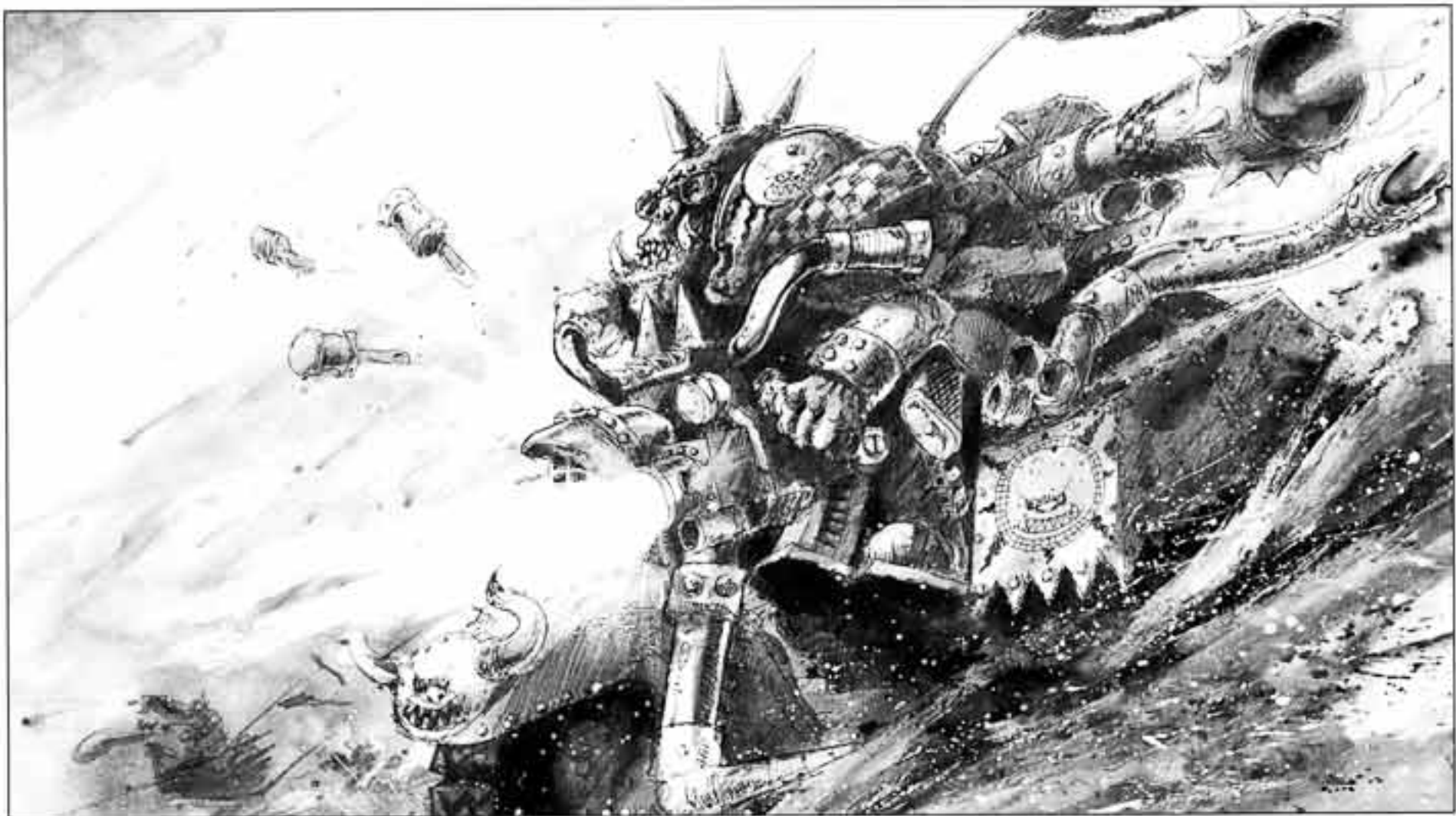

SPACE ORKS[®]

SPACE ORK WARTRAK SCORCHA

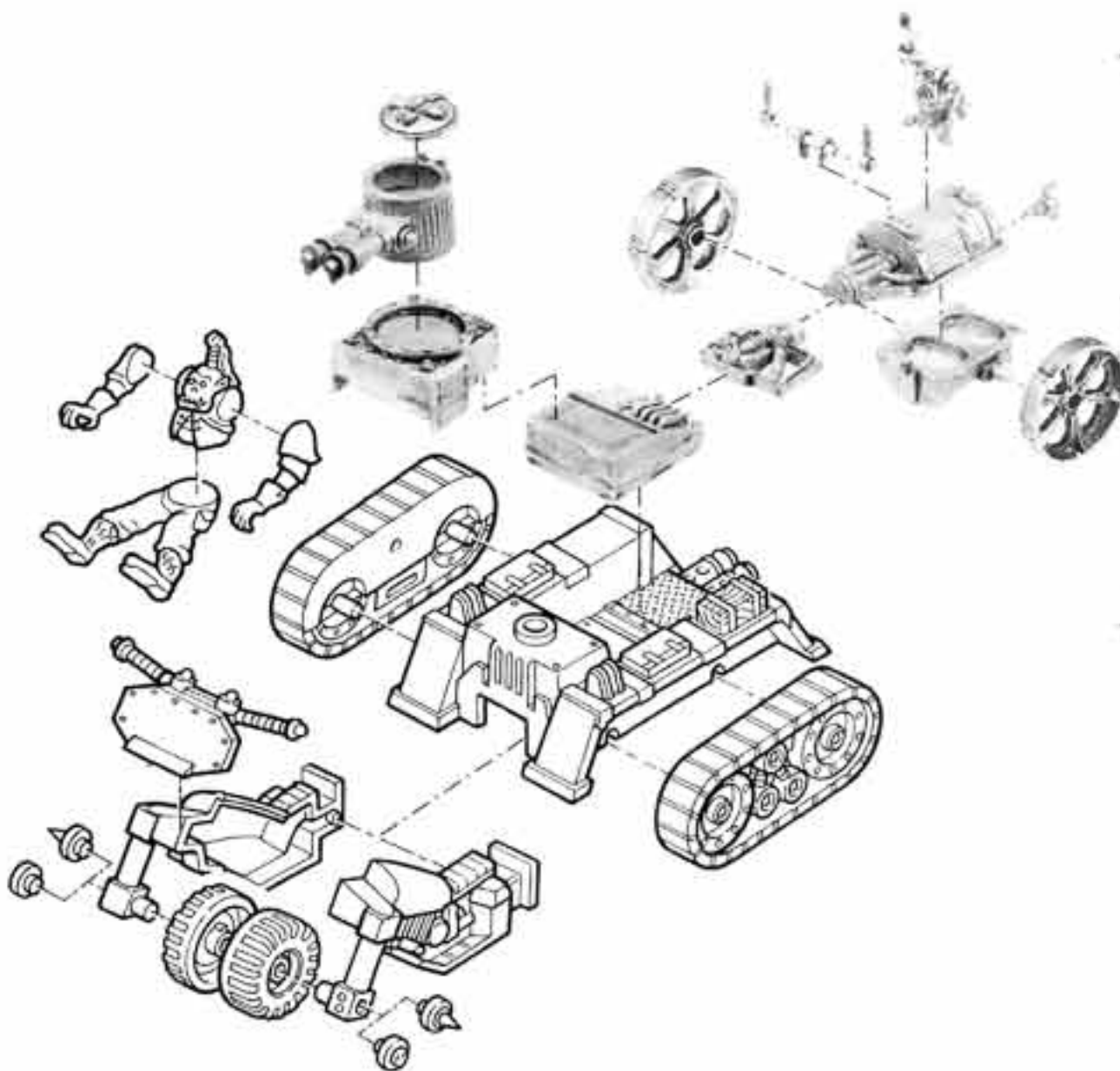

THE COMPLETE SPACE ORK WARTRAK SCORCHA CONSISTS OF:

- 1 x WARTRAK SCORCHA CUPOLA
- 1 x WARTRAK SCORCHA BASE PLATE
- 1 x WARTRAK SCORCHA SCORCHA
- 1 x WARTRAK SCORCHA TANK TOP
- 1 x WARTRAK SCORCHA TANK BOTTOM
- 1 x WARTRAK SCORCHA TRAILER COUPLING
- 1 x WARTRAK SCORCHA TAPS AND LEVERS SPRUE
- 1 x WARTRAK SCORCHA HATCH
- 1 x WARTRAK SCORCHA GAUGES
- 1 x WARTRAK SCORCHA SNOT PUMPER
- 1 x PLASTIC ARTILLERY WHEEL SPRUE
- 1 x PLASTIC WARTRAK SPRUE
- 1 x 40K ORK WHEEL SPRUE



SISTERS OF BATTLE™

CANONESS



CANONESS BODY
010800902



CANONESS ICON
010800903



SISTERS OF BATTLE BACK PACK
010800401



CANONESS

A COMPLETE CANONESS
CONSISTS OF:
1 x CANONESS BODY
1 x CANONESS ICON
1 x SISTERS OF BATTLE
BACK PACK

BATTLE SISTER WITH HEAVY FLAMER



BATTLE SISTER WITH
HEAVY FLAMER BODY
010800701



SISTERS OF BATTLE
HEAVY FLAMER
010800702



SISTERS OF BATTLE
HEAVY FLAMER BACK PACK
010800703



BATTLE SISTER WITH
HEAVY FLAMER

A COMPLETE BATTLE SISTER WITH HEAVY
FLAMER CONSISTS OF:
1 x BATTLE SISTER WITH HEAVY FLAMER BODY
1 x SISTERS OF BATTLE HEAVY FLAMER
1 x SISTERS OF BATTLE HEAVY FLAMER
BACK PACK

BATTLE SISTER WITH HEAVY BOLTER



BATTLE SISTER WITH
HEAVY BOLTER BODY
010800602



SISTERS OF BATTLE
HEAVY BOLTER
010800603



SISTERS OF BATTLE
BACK PACK
010800401



BATTLE SISTER WITH
HEAVY BOLTER

A COMPLETE BATTLE SISTER WITH
HEAVY BOLTER CONSISTS OF:
1 x BATTLE SISTER WITH
HEAVY BOLTER BODY
1 x SISTERS OF BATTLE
HEAVY BOLTER
1 x SISTERS OF BATTLE BACK PACK

BATTLE SISTER WITH MULTI-MELTA



BATTLE SISTER WITH
MULTI-MELTA BODY
010801601

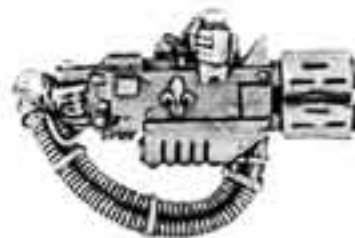

SISTERS OF BATTLE
MULTI-MELTA
010801602



SISTERS OF BATTLE
MULTI-MELTA BACK PACK
010801603



BATTLE SISTER WITH
MULTI-MELTA

A COMPLETE BATTLE SISTER WITH
MULTI-MELTA CONSISTS OF:
1 x BATTLE SISTER WITH
MULTI-MELTA BODY
1 x SISTERS OF BATTLE
MULTI-MELTA
1 x SISTERS OF BATTLE
MULTI-MELTA BACK PACK



SISTERS OF BATTLE™

SISTER SUPERIORS



SISTER SUPERIOR WITH
POWER SWORD AND BOLTER
010800402



SISTER SUPERIOR
WITH BOLTER
010801703



SISTER SUPERIOR WITH
POWER MAUL AND BOLTER
010801704

A COMPLETE SISTER SUPERIOR
CONSISTS OF:
1 x SISTER SUPERIOR
1 x SISTER OF BATTLE BACKPACK



SISTERS OF BATTLE
BACKPACK
010800401

SISTERS OF BATTLE



SISTER OF BATTLE 1
010800403



SISTER OF BATTLE 2
010800404



SISTER OF BATTLE 3
010800405



SISTER OF BATTLE 4
010800407



SISTER OF BATTLE 5
010801308



SISTER OF BATTLE 6
010801309



SISTER OF BATTLE 7
010801310



SISTER OF BATTLE
WITH FLAMER
010800406



SISTER OF BATTLE
WITH MELTA GUN
010800802



A COMPLETE SISTER OF BATTLE
CONSISTS OF:
1 x SISTER OF BATTLE
1 x SISTER OF BATTLE BACKPACK



SISTERS OF BATTLE
BACKPACK
010800401



SISTER OF BATTLE BANNER BEARER
010801501



Designed by Jes Goodwin

Not suitable for children under 36 months due to small parts and essential pointed components. All models supplied unpainted.
© Copyright Games Workshop Ltd., 1997. All rights reserved.

SISTERS OF BATTLE™

SISTERS OF BATTLE SERAPHIM



SERAPHIM SISTER SUPERIOR WITH
PLASMA PISTOL AND POWER SWORD
010801003



SERAPHIM WITH
HAND FLAMERS
010801005



SERAPHIM 1
010801002



SERAPHIM 2
010801004



SERAPHIM JUMP PACK
010801001

A COMPLETE SISTERS OF BATTLE
SERAPHIM CONSISTS OF:
1 x SISTERS OF BATTLE SERAPHIM
1 x SISTERS OF BATTLE SERAPHIM
JUMP PACK



SERAPHIM SQUAD



CITADEL
MINIATURES



CITADEL
MINIATURES

SISTERS OF BATTLE™

IMMOLATOR



IMMOLATOR GUNNER
010800501



IMMOLATOR HEAVY FLAMER
RIGHT SIDE
010800502

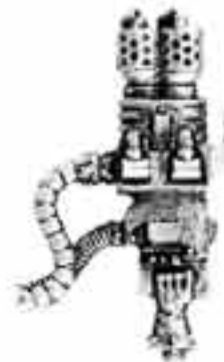

IMMOLATOR HEAVY FLAMER
LEFT SIDE
010800503



IMMOLATOR TURRET BASE
010800504



IMMOLATOR FRONT HATCH 1
010800505



IMMOLATOR FRONT HATCH 2
010800506

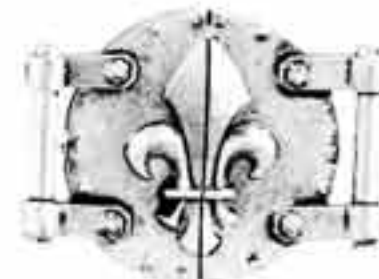

IMMOLATOR SIDE HATCH
010800507



IMMOLATOR UPPER TURRET BASE
010800508



IMMOLATOR BLAST SHIELD
010800509

A COMPLETE IMMOLATOR CONSISTS OF:

- 2 x RHINO CHASSIS SPRUES
- 2 x RHINO TRACK SPRUES
- 1 x IMMOLATOR GUNNER
- 1 x IMMOLATOR HEAVY FLAMER RIGHT SIDE
- 1 x IMMOLATOR HEAVY FLAMER LEFT SIDE
- 1 x IMMOLATOR TURRET BASE
- 1 x IMMOLATOR FRONT HATCH 1
- 1 x IMMOLATOR FRONT HATCH 2
- 2 x IMMOLATOR SIDE HATCHES
- 1 x IMMOLATOR UPPER TURRET BASE
- 1 x IMMOLATOR BLAST SHIELD
- 1 x IMMOLATOR TRANSFER SHEET



CITADEL
MINIATURES



CITADEL
MINIATURES

Designed by Jes Goodwin

Not suitable for children under 36 months due to small parts and essential pointed components. All models supplied unpainted.
© Copyright Games Workshop Ltd., 1997. All rights reserved.

SISTERS OF BATTLE™

REDEMPTOR KYRINOV, ARCH-CONFESSOR



REDEMPTOR KYRINOV BODY
010801101



MACE OF VALAAN
010801102

A COMPLETE REDEMPTOR
KYRINOV, ARCH-CONFESSOR
CONSISTS OF:
1 x REDEMPTOR KYRINOV BODY
1 x MACE OF VALAAN



REDEMPTOR KYRINOV,
ARCH-CONFESSOR

IMPERIAL MISSIONARIES



IMPERIAL MISSIONARY 1 BODY
010801201



IMPERIAL MISSIONARY 2 BODY
010801204



IMPERIAL MISSIONARY
CHAIN SWORD
010801202



IMPERIAL MISSIONARY
BACK PACK 1
010801203



IMPERIAL MISSIONARY
BACK PACK 2
010801205



IMPERIAL MISSIONARY 1



IMPERIAL MISSIONARY 2

A COMPLETE IMPERIAL MISSIONARY 1
CONSISTS OF:
1 x IMPERIAL MISSIONARY 1 BODY
1 x IMPERIAL MISSIONARY BACK PACK 1
1 x IMPERIAL MISSIONARY CHAIN SWORD

A COMPLETE IMPERIAL MISSIONARY 2
CONSISTS OF:
1 x IMPERIAL MISSIONARY 2 BODY
1 x IMPERIAL MISSIONARY BACK PACK 2



HEROES OF THE IMPERIUM™

URIAH JACOBUS, PROTECTOR OF THE FAITH



URIAH JACOBUS BODY
010802101

A COMPLETE URIAH JACOBUS, PROTECTOR OF THE FAITH CONSISTS OF:
1 x URIAH JACOBUS BODY
1 x URIAH JACOBUS RIGHT ARM
1 x URIAH JACOBUS BACKPACK



URIAH JACOBUS RIGHT ARM
010802102



URIAH JACOBUS BACKPACK
010802103



URIAH JACOBUS,
PROTECTOR OF THE FAITH

IMPERIAL PREACHERS



IMPERIAL PREACHER 1
010802201



IMPERIAL PREACHER 2
010802202



IMPERIAL PREACHER 3
010802203



HEROES OF THE IMPERIUM

IMPERIAL ASSASSIN – EVERSOR



EVERSOR 1 BODY
010800301



EVERSOR 2 BODY
010800304



EVERSOR 1 EXECUTOR PISTOL
010800302



EVERSOR 2 POWER SWORD
010800305



EVERSOR 1 SENTINEL ARRAY
010800303



EVERSOR 2 SENTINEL ARRAY
010800306



IMPERIAL ASSASSINS – EVERSOR

A COMPLETE IMPERIAL ASSASSIN –
EVERSOR 1 CONSISTS OF:
1 x EVERSOR 1 BODY
1 x EVERSOR 1 EXECUTOR PISTOL
1 x EVERSOR 1 SENTINEL ARRAY

A COMPLETE IMPERIAL ASSASSIN –
EVERSOR 2 CONSISTS OF:
1 x EVERSOR 2 BODY
1 x EVERSOR 2 POWER SWORD
1 x EVERSOR 2 SENTINEL ARRAY

IMPERIAL ASSASSIN – CALLIDUS



CALLIDUS 1 BODY
010800201



CALLIDUS 1 LEGS
010800202



IMPERIAL ASSASSIN
CALLIDUS 1



CALLIDUS 2
010800203



THE COMPLETE CALLIDUS 1 CONSISTS OF:
1 x CALLIDUS 1 BODY
1 x CALLIDUS 1 LEGS



Designed by Jes Goodwin

HEROES OF THE IMPERIUM

IMPERIAL ASSASSIN – VINDICARE



VINDICARE 1 BODY
010800101



VINDICARE 2 BODY
010800103



VINDICARE 1 EXITUS LONG RIFLE
010800102



VINDICARE 2 EXITUS LONG RIFLE
010800104

THE COMPLETE IMPERIAL ASSASSIN – VINDICARE 1 CONSISTS OF:
1 x VINDICARE 1 BODY
1 x VINDICARE 1 EXITUS LONG RIFLE

THE COMPLETE IMPERIAL ASSASSIN – VINDICARE 2 CONSISTS OF:
1 x VINDICARE 2 BODY
1 x VINDICARE 2 EXITUS LONG RIFLE



IMPERIAL ASSASSINS – VINDICARE

IMPERIAL ASSASSIN – CULEXUS



CULEXUS BODY
010802601



CULEXUS HEAD 1
010802603



CULEXUS HEAD 2
010802604



CULEXUS EYE
010802602

THE COMPLETE IMPERIAL ASSASSIN – CULEXUS CONSISTS OF:
1 x CULEXUS BODY
1 x CULEXUS HEAD
1 x CULEXUS EYE



IMPERIAL ASSASSIN – CULEXUS



Designed by Jes Goodwin

Not suitable for children under 8 years due to small parts and essential pointed components. All models supplied unpainted.
© Copyright Games Workshop Ltd. 1998. All rights reserved.

WARHAMMER 40,000®

WARHAMMER 40,000 RUINED BUILDINGS

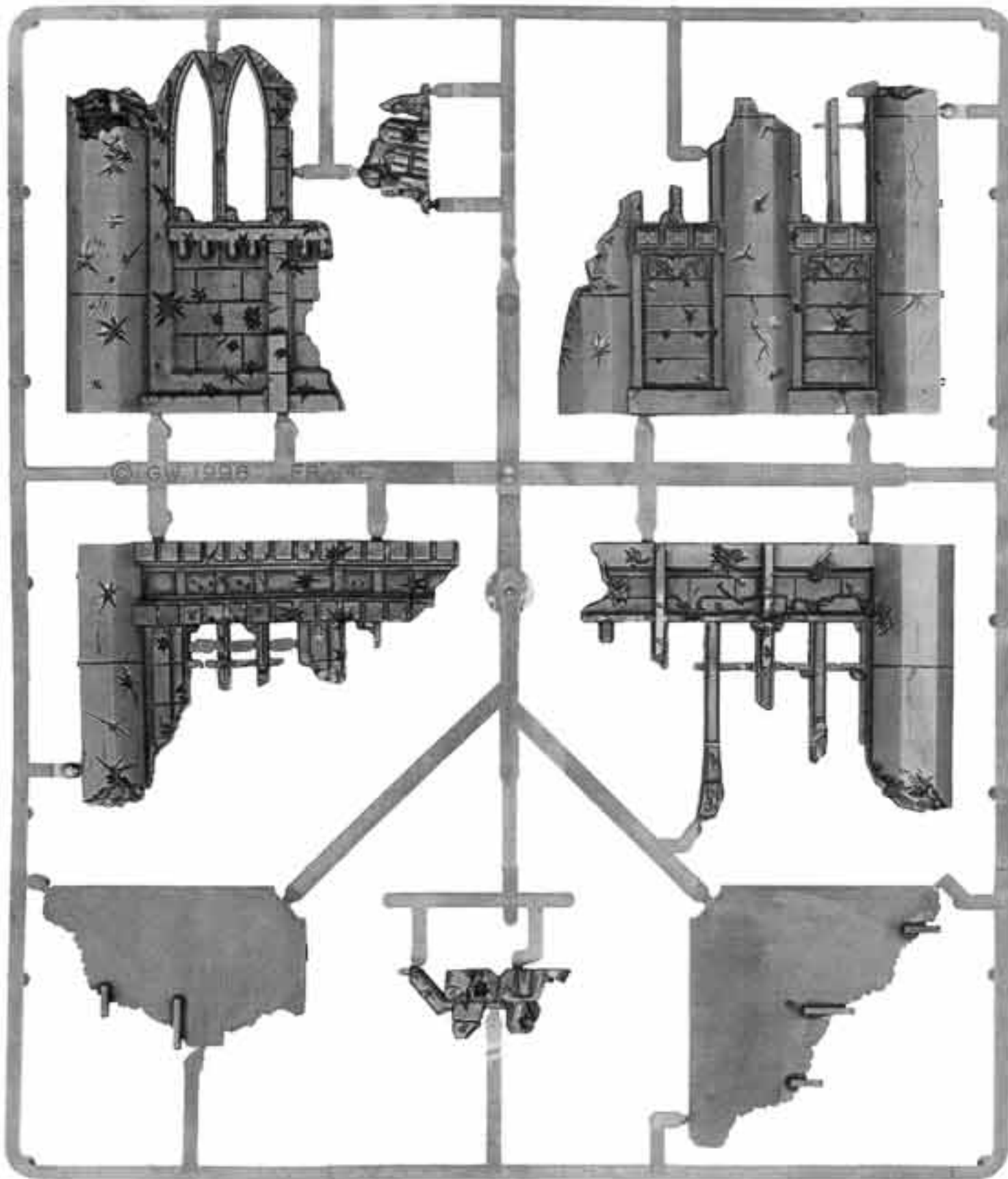
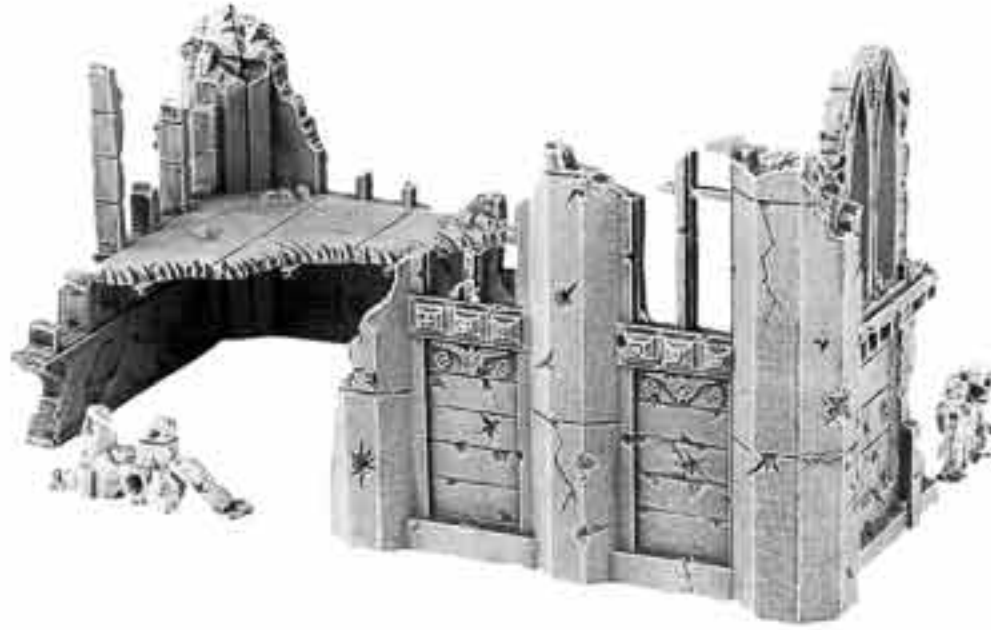

WARHAMMER 40,000 RUINS SPRUE 1 (SHOWN AT 50% OF ACTUAL SIZE)
99390199003



CITADEL
MINIATURES



CITADEL
MINIATURES

WARHAMMER 40,000[®]

WARHAMMER 40,000 RUINED BUILDINGS

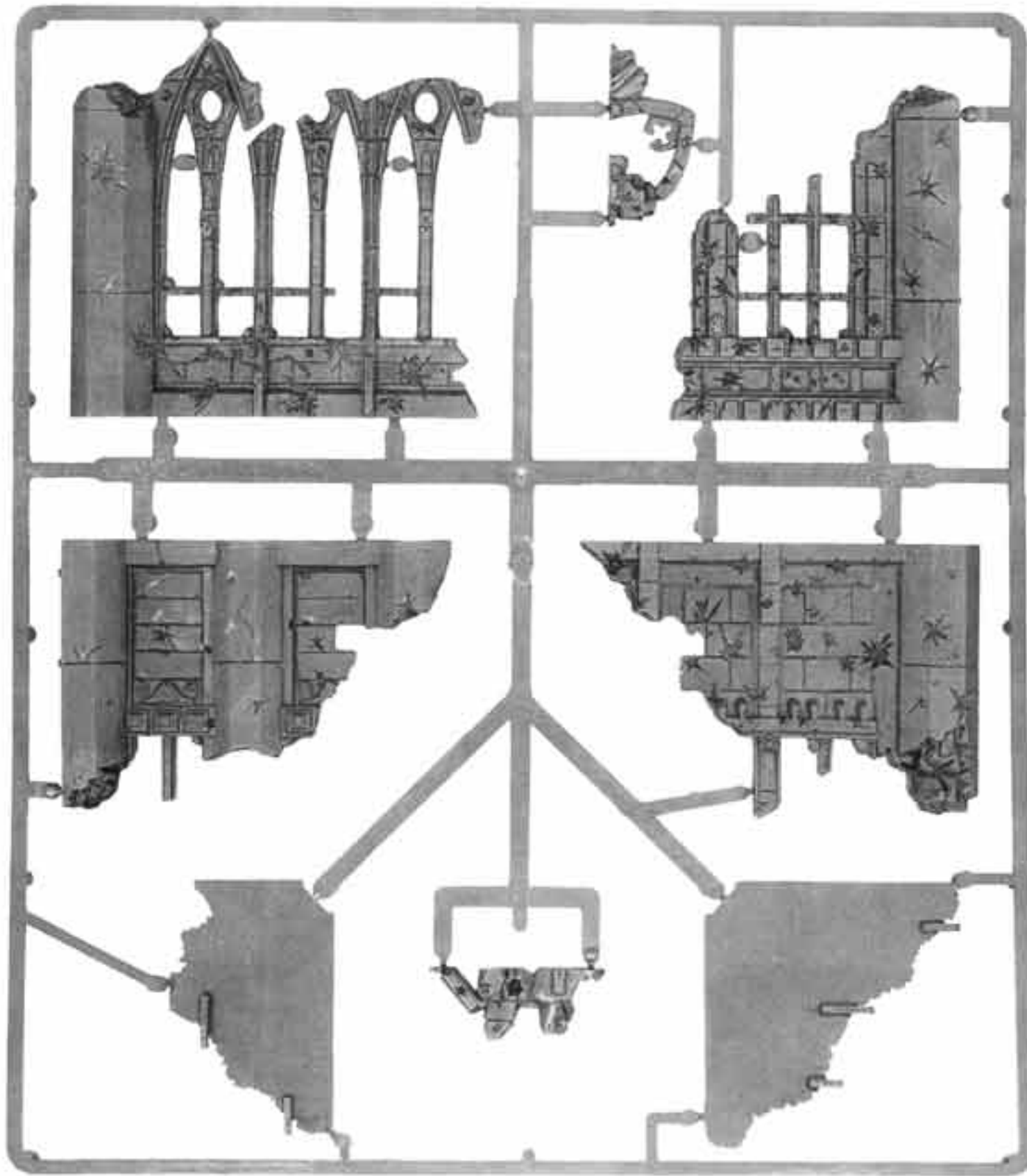

WARHAMMER 40,000 RUINS SPRUE 2 (SHOWN AT 50% OF ACTUAL SIZE)
99390199002



CITADEL[®]
MINIATURES



CITADEL[®]
MINIATURES

Designed by the Citadel Modelling Team

Not suitable for children under 8 years due to small parts and essential pointed components. All models supplied unpainted.
© Copyright Games Workshop Ltd. 1998. All rights reserved.

WARHAMMER 40,000®

WARHAMMER 40,000 PLASTIC TREES

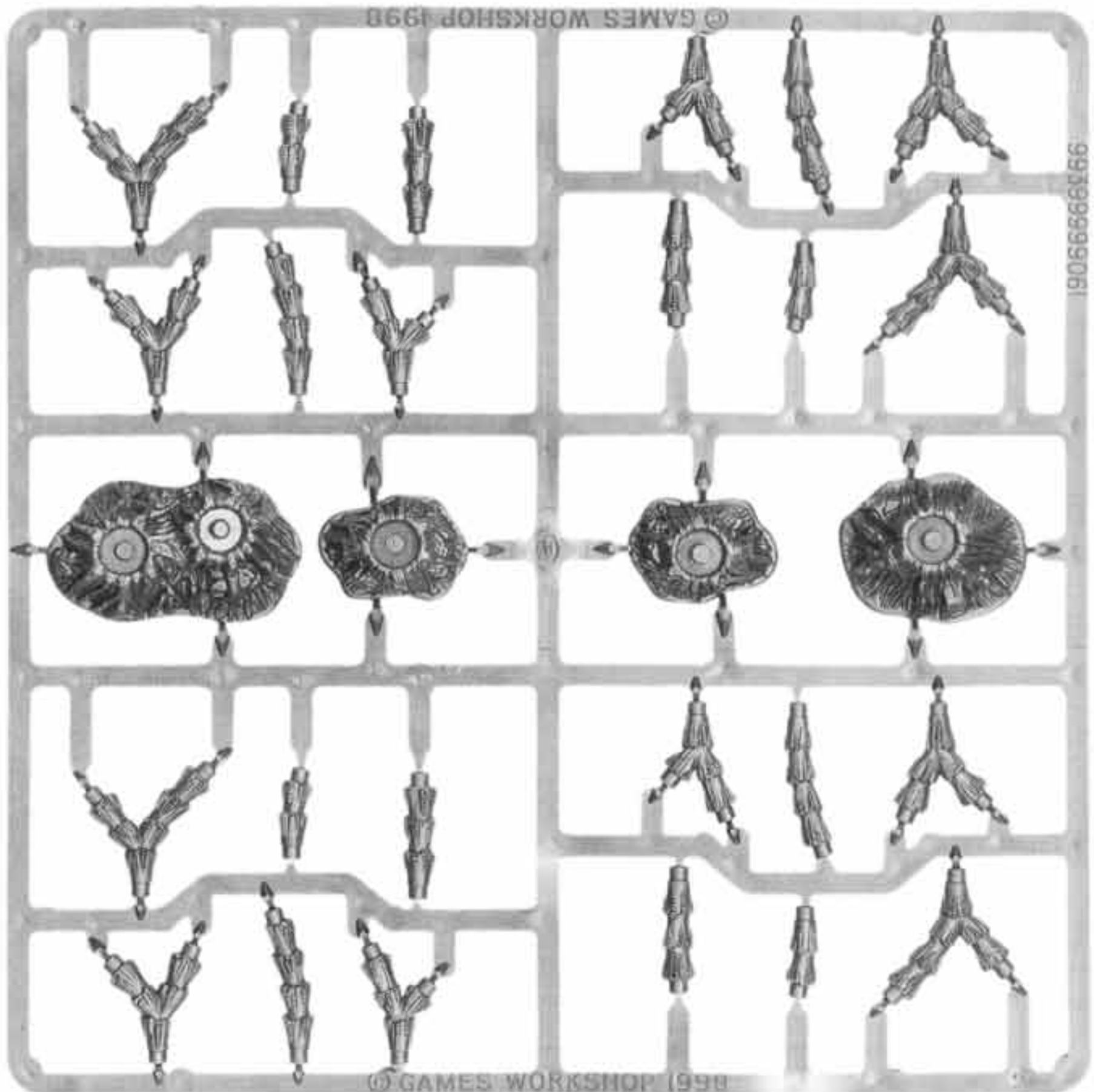

WARHAMMER 40,000 TREE SPRUE 1 (SHOWN AT 95% OF ACTUAL SIZE)
99399999061

Designed by the Citadel Modelling Team

Not suitable for children under 8 years due to small parts and essential pointed components. All models supplied unpainted.
© Copyright Games Workshop Ltd. 1998. All rights reserved.



WARHAMMER 40,000[®]

WARHAMMER 40,000 PLASTIC TREES

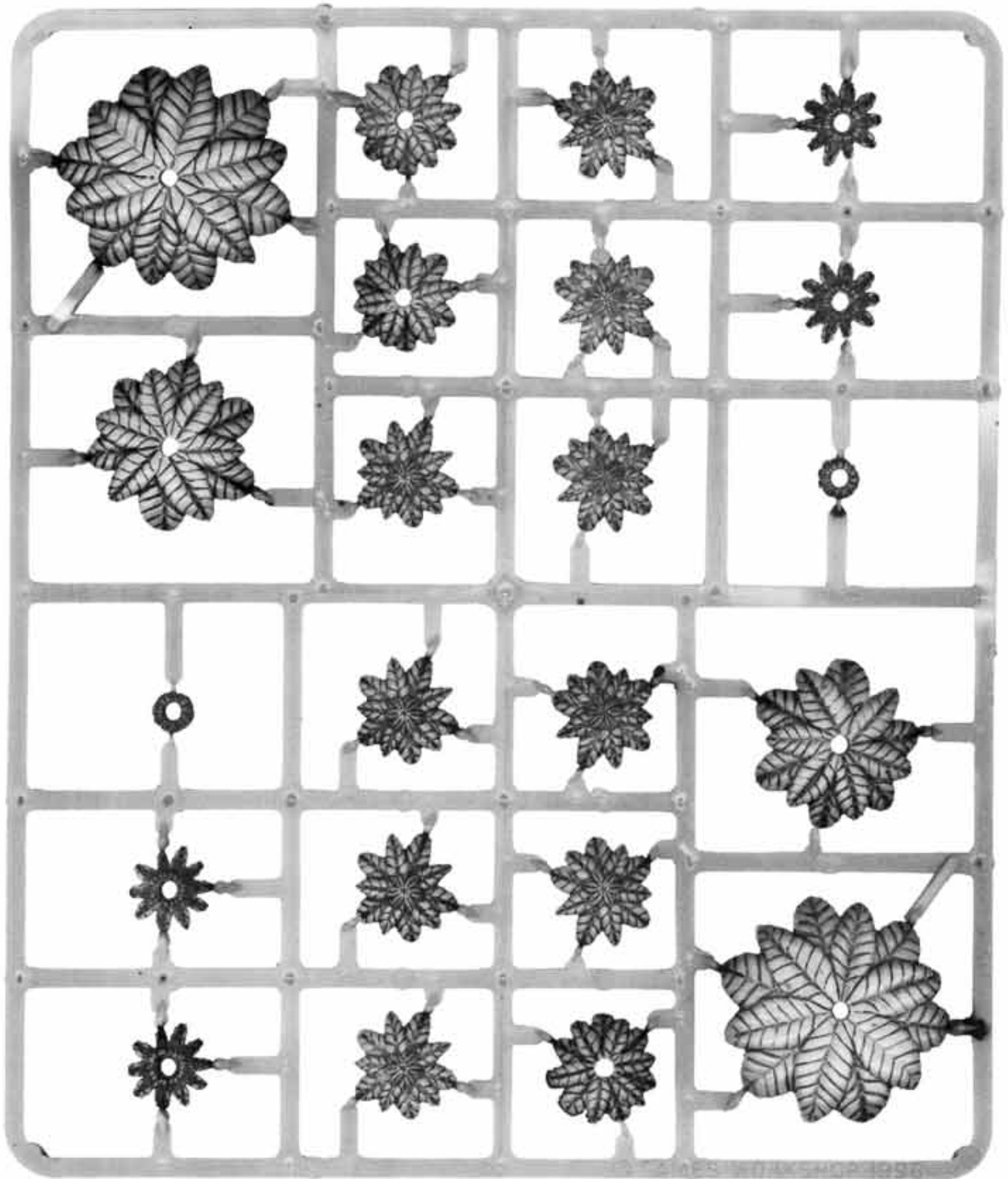

WARHAMMER 40,000 TREE SPRUE 2 (SHOWN AT 95% OF ACTUAL SIZE)
99399999060

Designed by the Citadel Modelling Team

Not suitable for children under 8 years due to small parts and essential pointed components. All models supplied unpainted.
© Copyright Games Workshop Ltd. 1998. All rights reserved.



WARHAMMER 40,000[®]

WARHAMMER 40,000 VEHICLE ACCESSORY SPRUE

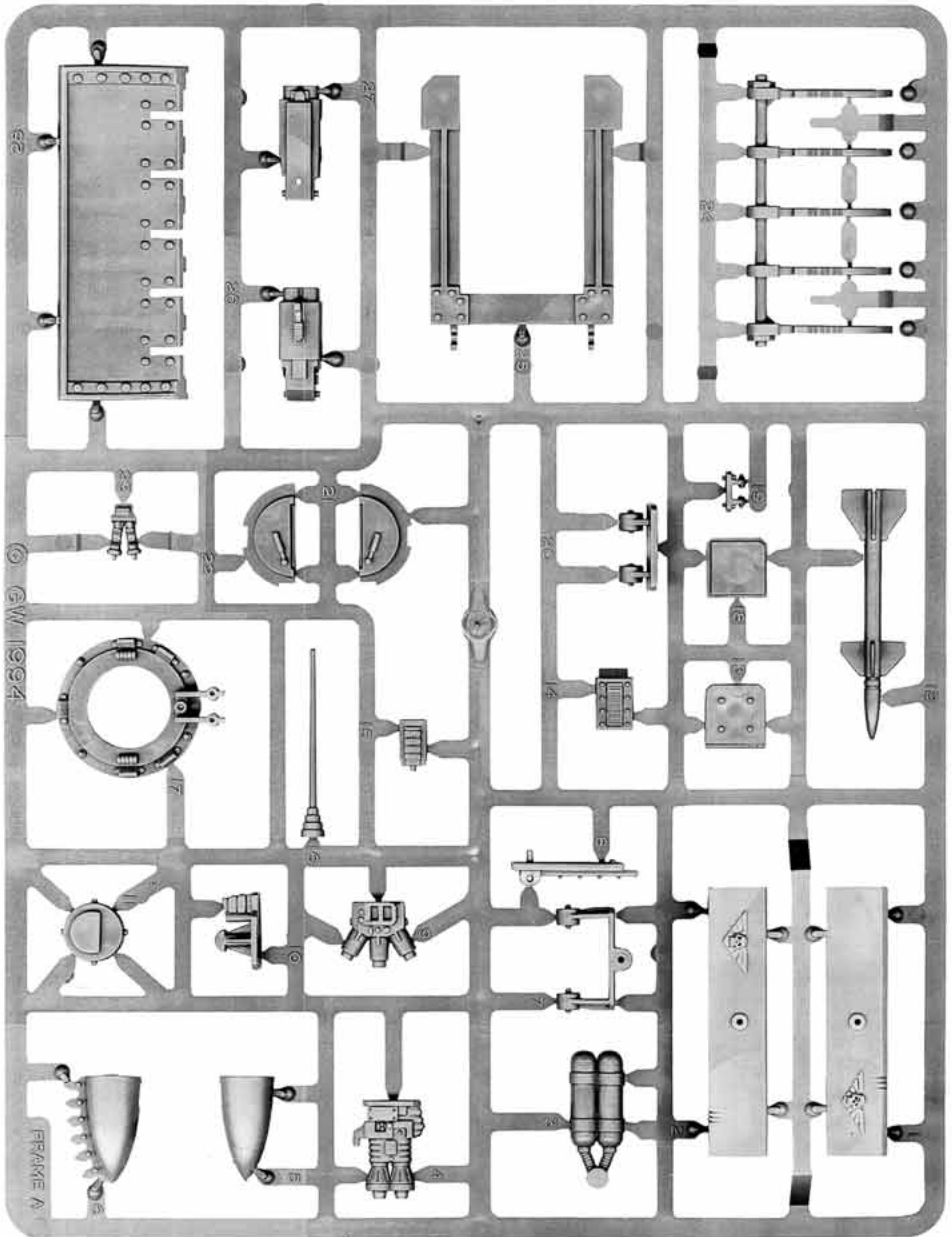

WARHAMMER 40,000 VEHICLE ACCESSORY SPRUE
99399999035

Designed by the Citadel Design Team

Not suitable for children under 8 years due to small parts and essential pointed components. All models supplied unpainted.
© Copyright Games Workshop Ltd. 1998. All rights reserved.

WARHAMMER 40,000[®]

WARHAMMER 40,000 AMMO CRATES ACCESSORY SPRUE

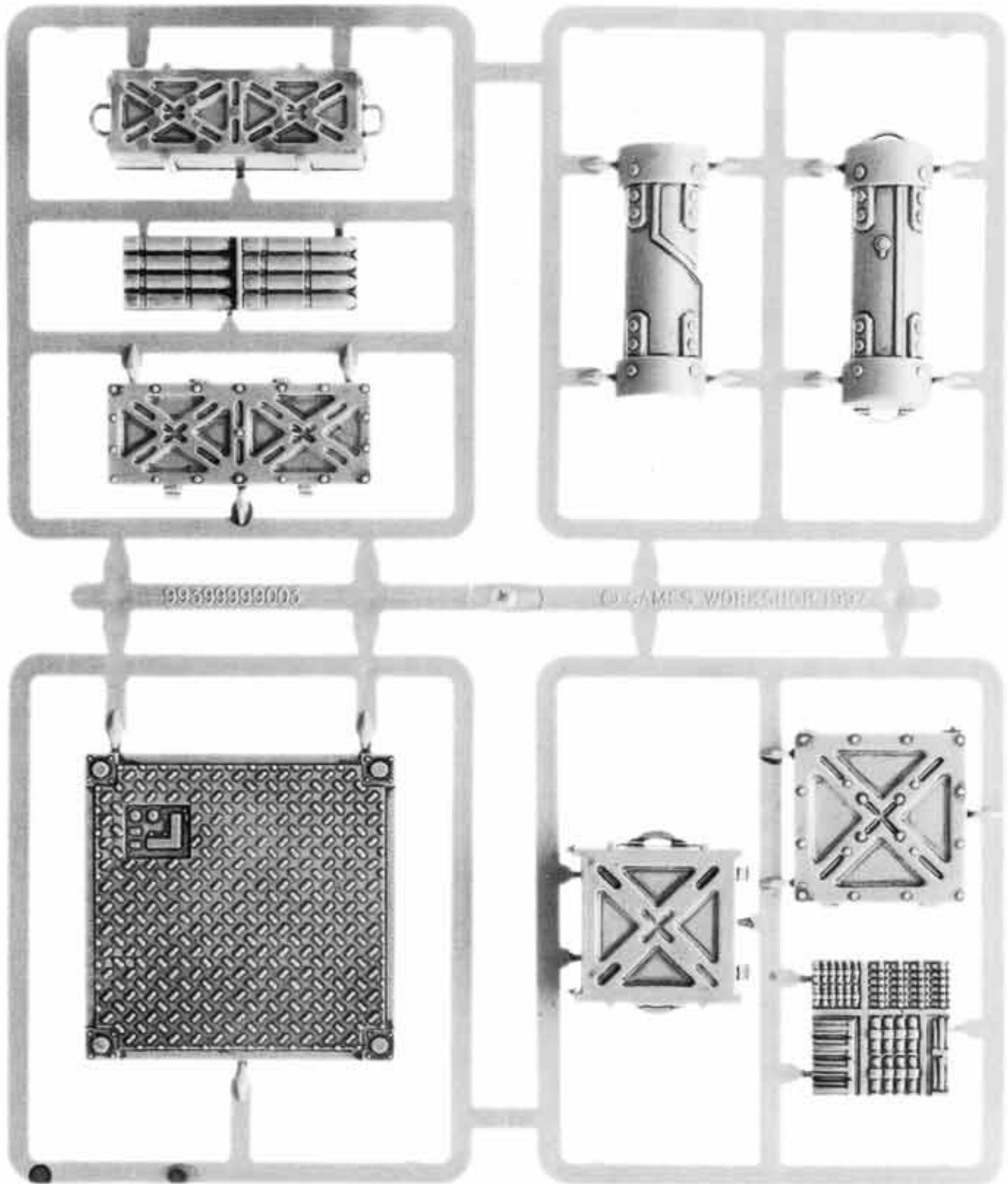

WARHAMMER 40,000 AMMO CRATES ACCESSORY SPRUE
99399999003
(SHOWN AT ACTUAL SIZE)



CITADEL
MINIATURES



CITADEL
MINIATURES

Designed by the Citadel Design Team

Not suitable for children under 8 years due to small parts and essential pointed components. All models supplied unpainted.
© Copyright Games Workshop Ltd. 1998. All rights reserved.

WARHAMMER 40,000

WARHAMMER 40,000 BARRICADES SPRUE

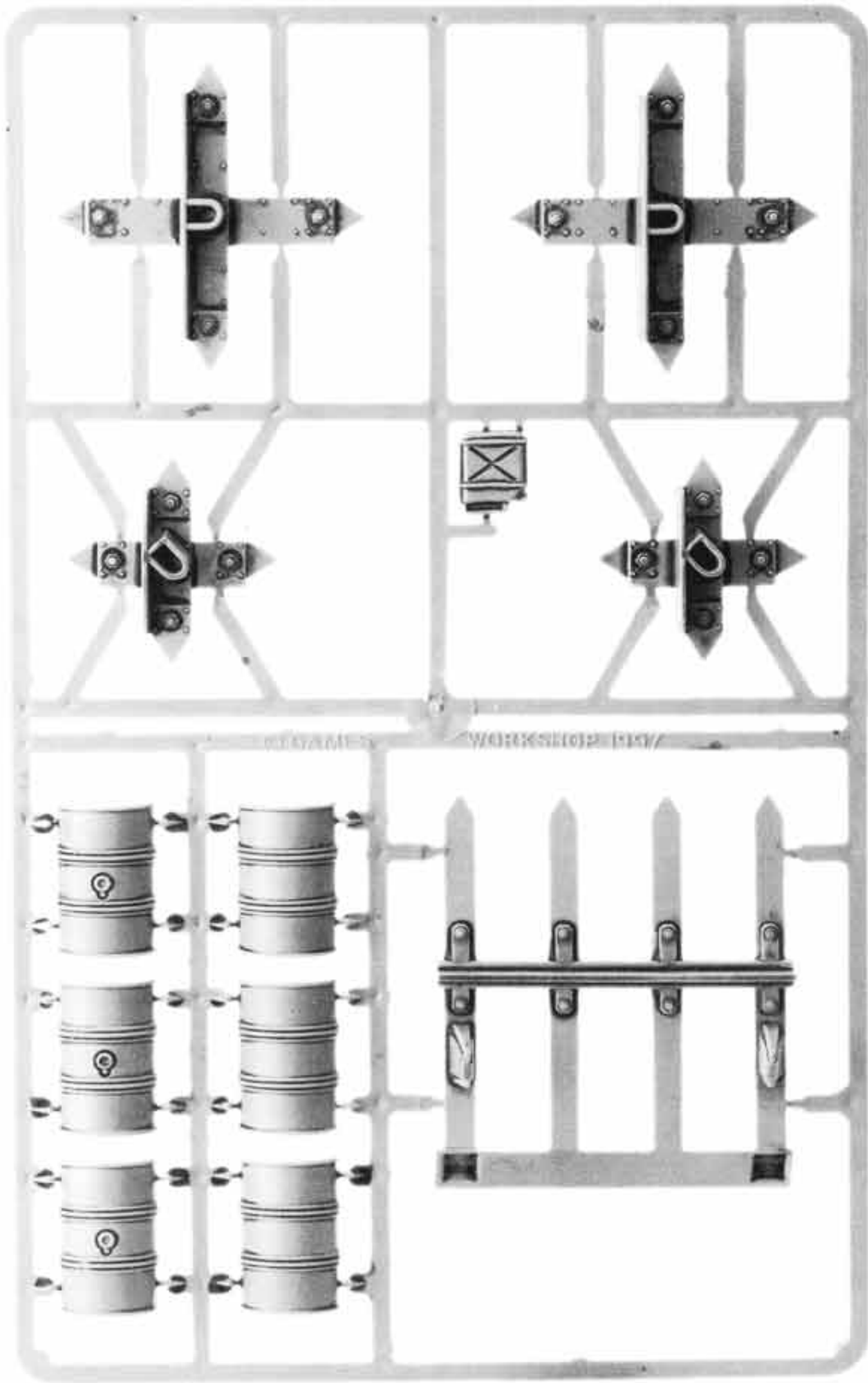

WARHAMMER 40,000 BARRICADES ACCESSORY SPRUE

99390499001

(SHOWN AT 90% ACTUAL SIZE)

Designed by the Citadel Design Team



GORKAMORKA



GORKAMORKA™

BOYZ WITH HAND-TO-HAND WEAPONS



ORK BOY WITH
HAND-TO-HAND WEAPON 1
040301001



ORK BOY WITH
HAND-TO-HAND WEAPON 2
040301002



ORK BOY WITH
HAND-TO-HAND WEAPON 3
040301003



ORK BOY WITH
HAND-TO-HAND WEAPON 4
040301004

YOOFs



YOOF BODY 1
040300701



YOOF BODY 2
040300702



YOOF BODY 3
040300703



YOOF ARM 1
040300704



YOOF ARM 2
040300705



YOOF ARM 3
040300706



YOOF ARM 4
040300707



YOOF ARM 5
040300709



YOOF ARM 6
040300708

A COMPLETE YOOF
CONSISTS OF:
1 x YOOF BODY
1 x YOOF ARM



COMPLETE YOOF



GORKAMORKA™

ORK BOYZ WITH BLUNDERBUSS



ORK BOY
WITH BLUNDERBUSS 1
040301701



ORK BOY
WITH BLUNDERBUSS 2
040301702

ORK BOYZ WITH KANNONS



ORK BOY
WITH KANNON 2
040300902



ORK BOY
WITH KANNON 1
040300901



ORK BOY
WITH KANNON 3
040300909



ORK BOY 1
040300903



ORK BOY 2
040300904



KANNON ARM
040300905



BLUNDERBUSS ARM
040301704



COMPLETE ORK BOY
WITH BLUNDERBUSS



COMPLETE ORK BOY
WITH KANNON

A COMPLETE ORK BOY 1 OR 2
CONSISTS OF:
1x ORK BOY 1 OR 2
1x KANNON OR BLUNDERBUSS ARM



GORRKAMORKA™

ORK BOYZ WITH SHOOTAS



ORK BOY WITH
PICK AND SHOOTA
040300601



ORK BOY WITH
AXE AND SHOOTA
040300602



ORK BOY WITH
KNUCKLES AND SHOOTA
040300603



ORK BOY WITH
STIKKBOMB AND SHOOTA
040300605



ORK BOY WITH SHOOTA 1
040300606



ORK BOY WITH SHOOTA 2
040300607



ORK BOY WITH SHOOTA 3
040300608



ORK BOY WITH SHOOTA 4
040300609



GORKAMORKA™

ORK BIONICS



HEAD WITH STEEL HORNS
040301801



HEAD WITH STEEL SKULL
040301802



HEAD WITH BIONIC EYE
040301803



KUSTOM THRUSTER BOOSTA
040301804



IRON LUNG
040301805



GYRO MONOWHEEL
040301806



GYRO STABILISER
040301807



PEG LEG
040301808



DELUXE KICKING LEGS
040301809



SHOOTA ARM
040301810



SPEAR ARM
040301811



HOOK ARM
040301812



KUTTA ARM
040301813

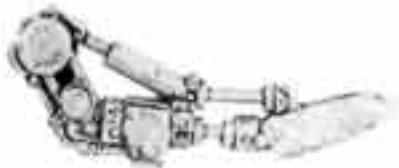

KUTTA ARM 2
040301814



CLAW ARM
040301815

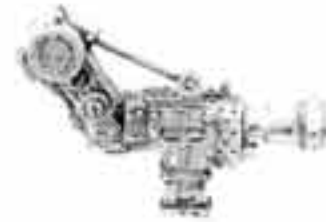

SHOOTA ARM 2
040301816



ORK WITH GYRO-STABILISED
MONOWHEEL AND KUSTOM
THRUSTER BOOSTA



ORK WITH BIONIC
CLAW ARM



ORK WITH BIONIC
KUTTA ARM 2

EXAMPLES OF PLASTIC ORKS WITH BIONIC COMPONENTS



CITADEL
MINIATURES



CITADEL
MINIATURES

Designed by Colin Dixon

Not recommended for children under 8 years due to small parts and essential pointed components. All models supplied unpainted.
© Copyright Games Workshop Ltd. 1998. All rights reserved.

GORKAMORKA™

DREGMEK BLITZKART



DREGMEK'S BODY
040302301



DREGMEK'S RIGHT ARM WITH SIX SHOOTA
040302303



DREGMEK'S LEGS
040302302



DREGMEK'S LEFT ARM
040302304

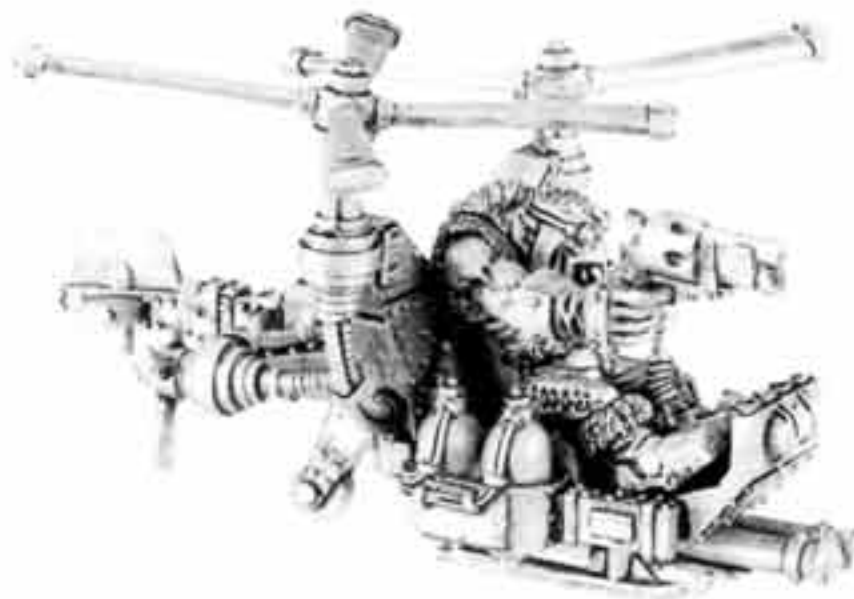

DREGMEK BLITZKART ON DETH KOPTA

A COMPLETE DREGMEK BLITZKART ON DETH KOPTA CONSISTS OF:

- 1 x DREGMEK'S BODY
- 1 x DREGMEK'S LEGS
- 1 x DREGMEK'S RIGHT ARM WITH SIX SHOOTA
- 1 x DREGMEK'S LEFT ARM
- 1 x DETH KOPTA ROTARY BLADE SUPPORT
- 1 x DETH KOPTA ENGINE
- 1 x DETH KOPTA LINKED KANNONS
- 1 x DETH KOPTA ROTARY BLADES A
- 1 x DETH KOPTA ROTARY BLADES B
- 1 x DETH KOPTA TAIL
- 2 x DETH KOPTA LANDING RUNNERS
- 2 x DETH KOPTA SMALL ROTARY BLADES
- 1 x DETH KOPTA REAR WHEEL
- 1 x DETH KOPTA CHASSIS
- 1 x DETH KOPTA CONTROL STICK

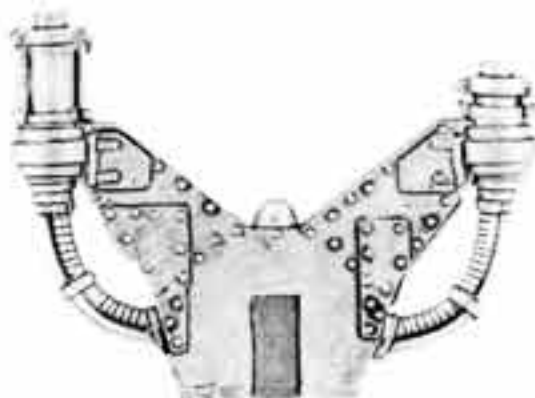

DETH KOPTA ROTARY BLADE SUPPORT
040302305



DETH KOPTA ROTARY BLADES A
040302308

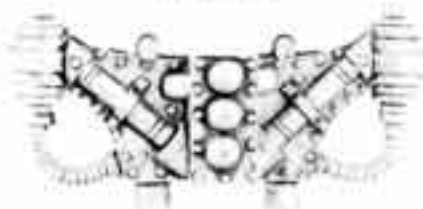

DETH KOPTA ENGINE
040302306



DETH KOPTA ROTARY BLADES B
040302309

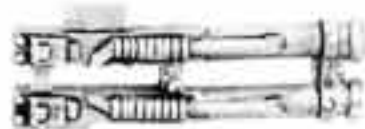

DETH KOPTA LINKED KANNONS
040302307



DETH KOPTA TAIL
040302310



DETH KOPTA LANDING RUNNERS
040302311

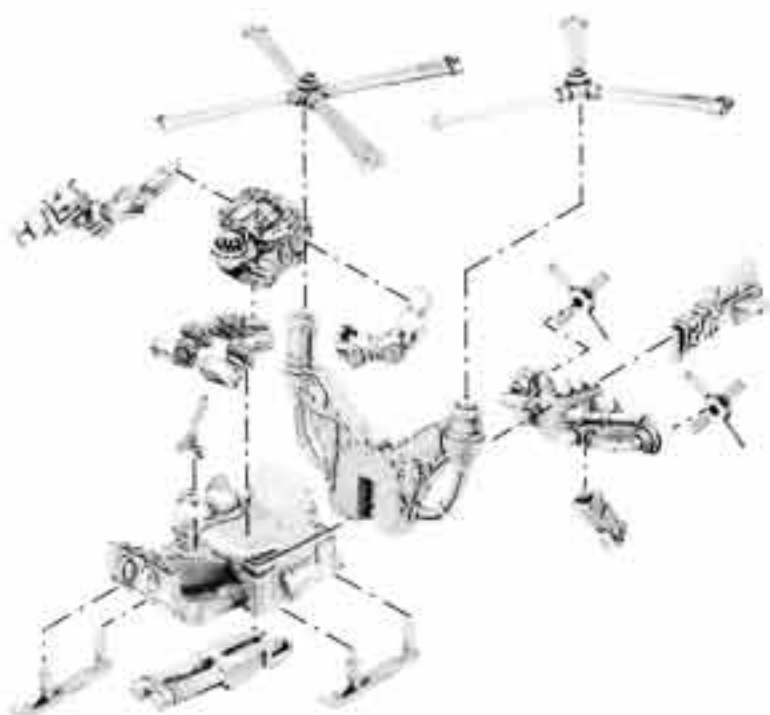

DETH KOPTA SMALL ROTARY BLADES
040302312

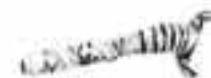

DETH KOPTA CONTROL STICK
040302315



DETH KOPTA REAR WHEEL
040302313

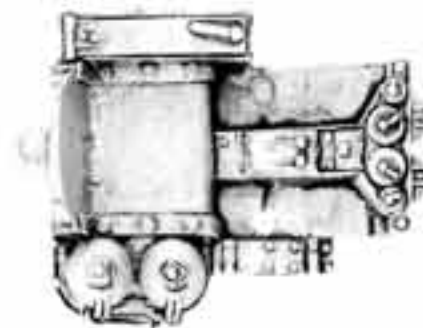

DETH KOPTA CHASSIS
040302314



GORKAMORKA™

ORK BIKER



ORK BIKER

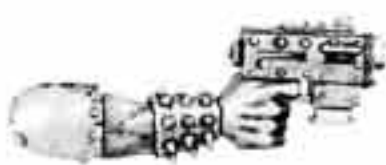
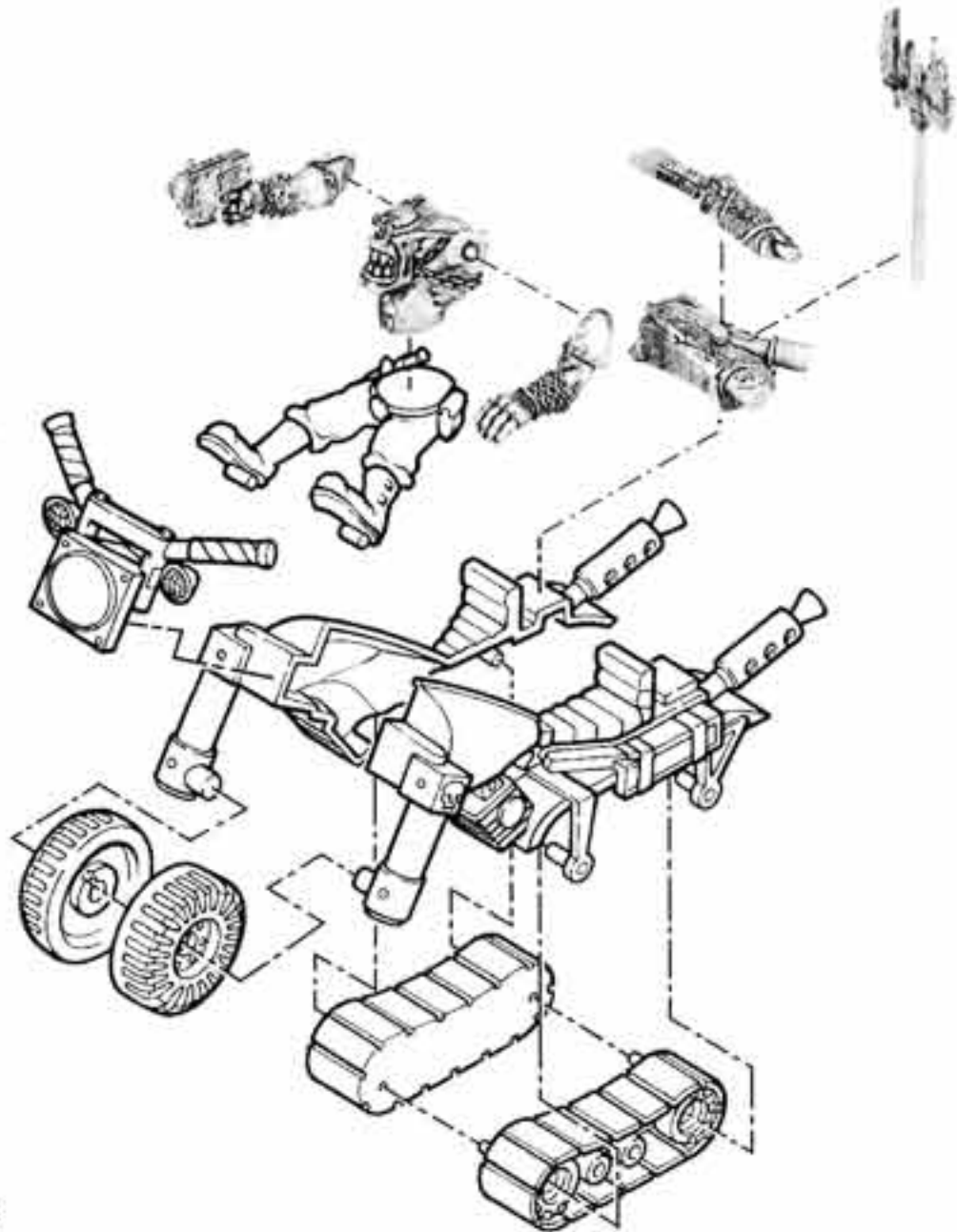

ORK BIKER RIGHT ARM
040302002



ORK BIKER LEFT ARM
040302003



ORK BIKER UPPER BODY
040302001

A COMPLETE ORK BIKER CONSISTS OF:

- 1 x ORK BIKER UPPER BODY
- 1 x ORK BIKER BACK PACK
- 1 x ORK BIKER KANNON
- 1 x ORK BIKER RIGHT ARM
- 1 x ORK BIKER LEFT ARM
- 1 x ORK BIKER ICON
- 1 x WAR BIKE PLASTIC SPRUE
- 1 x SMALL PLASTIC WHEEL



ORK BIKER ICON
040302005



ORK BIKER KANNON
040302006



ORK BIKER BACKPACK
040302004



CITADEL
MINIATURES



CITADEL
MINIATURES

Designed by Brian Nelson

169

Not suitable for children under 36 months due to small parts and essential pointed components. All models supplied unpainted.
© Copyright Games Workshop Ltd., 1997. All rights reserved.

GORKAMORKA™

BIG GRABBER



BIG GRABBER JAWS
040301902



BIG GRABBER CRANE
040301901

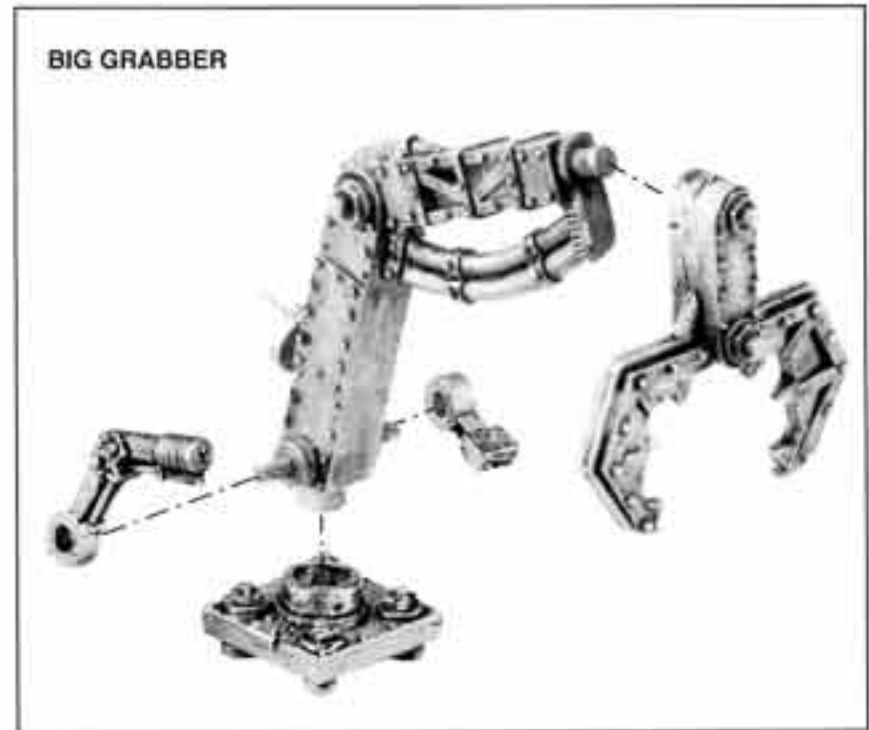

BIG GRABBER



**WRECKER TRUKK
WRECKER HANDLE**
040301606



**BIG GRABBER
SHOOTA**
040301904



**BIG GRABBER
SLUGGA**
040301906



**WRECKER TRUKK
WRECKER BASE**
040301513



**WRECKER TRUKK
WRECKER PEDAL**
040301608



**BIG GRABBER
HAMMER**
040301905



**BIG GRABBER
BLOWTORCH**
040301907



**BIG GRABBER
SPIKE**
040301903

A COMPLETE BIG GRABBER TRUKK CONSISTS OF:

- 1 x BIG GRABBER JAWS
- 1 x BIG GRABBER CRANE
- 1 x WRECKER TRUKK WRECKER BASE
- 1 x WRECKER TRUKK WRECKER HANDLE
- 1 x WRECKER TRUKK WRECKER PEDAL
- 1 x BIG GRABBER HAMMER
- 1 x BIG GRABBER SHOOTA
- 1 x BIG GRABBER SLUGGA
- 1 x BIG GRABBER BLOWTORCH
- 2 x BIG GRABBER SPIKE
- 1 x WARTRUKK SPRUE
- 2 x PLASTIC LARGE TYRED WHEEL
- 2 x PLASTIC ORK WHEEL



BIG GRABBER ON TRUKK



CITADEL
MINIATURES



CITADEL
MINIATURES

GORKAMORKA™

WRECKER TRUKK

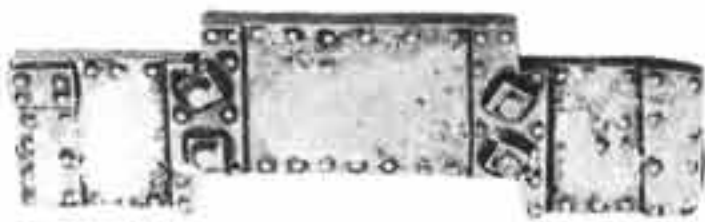

WRECKER TRUKK
FRONT PLATE
040301601

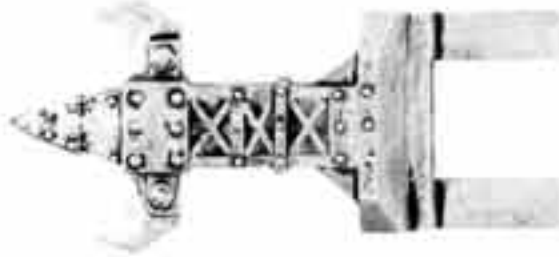

WRECKER TRUKK
BATTERING RAM
040301602



WRECKER TRUKK
WRECKER BASE
040301513



WRECKER TRUKK
WRECKER MAIN SUPPORT
040301603



WRECKER TRUKK
WRECKER BALL AND CHAIN
040301604



WRECKER TRUKK
AMMO BOX
040301614



WRECKER TRUKK
WRECKER BALL
040301605

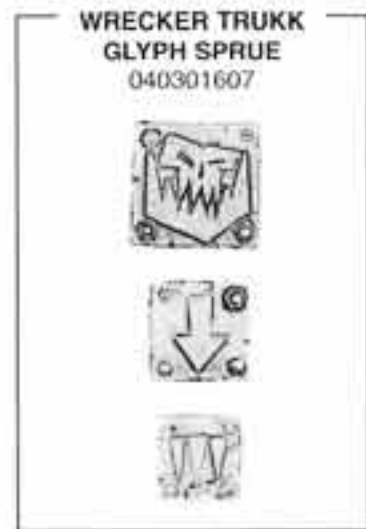

WRECKER TRUKK
GLYPH SPRUE
040301607



WRECKER TRUKK
DRIVER
040301610



WRECKER TRUKK
GUNNER
040301611



WRECKER TRUKK
WRECKER HANDLE
040301606



WRECKER TRUKK
WRECKER PEDAL
040301608



WRECKER TRUKK
SKULL SPIKE
040301612



WRECKER TRUKK
KANNON
040301609

WRECKER



A COMPLETE WRECKER TRUKK CONSISTS OF:

- 1 x WRECKER TRUKK FRONT PLATE
- 1 x WRECKER TRUKK BATTERING RAM
- 1 x WRECKER TRUKK AMMO BOX
- 1 x WRECKER TRUKK SKULL SPIKE
- 1 x WRECKER TRUKK KANNON
- 1 x WRECKER TRUKK GLYPH SPRUE
- 1 x WRECKER TRUKK DRIVER
- 1 x WRECKER TRUKK GUNNER
- 2 x LARGE PLASTIC WHEELS
- 1 x WRECKER TRUKK WRECKER BASE

- 1 x WRECKER TRUKK
WRECKER MAIN SUPPORT
- 1 x WRECKER TRUKK
WRECKER BALL AND CHAIN
- 1 x WRECKER TRUKK
WRECKER HANDLE
- 1 x WRECKER TRUKK
WRECKER BALL
- 1 x WRECKER TRUKK
WRECKER PEDAL
- 1 x PLASTIC WAR TRUKK SPRUE
- 2 x SMALL PLASTIC WHEELS



WRECKER TRUKK

Designed by Norman Swales and Brian Nelson

Not suitable for children under 8 years due to small parts and essential pointed components. All models supplied unpainted.
© Copyright Games Workshop Ltd. 1998. All rights reserved.

GORKAMORKA™

SPEARGUN WAR TRUKK



SPEARGUN WAR TRUKK

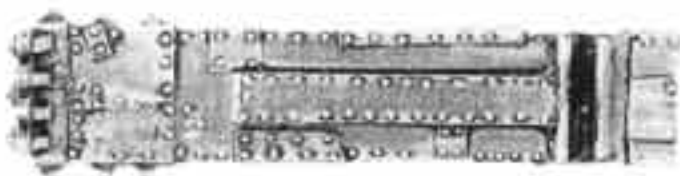

SPEARGUN GANG PLANK
040301504

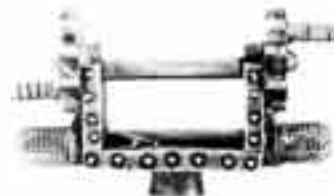

SPEARGUN GANG PLANK WINCH
040301509

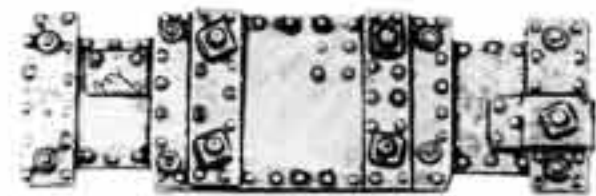

SPEARGUN FRONT PLATE
040301501

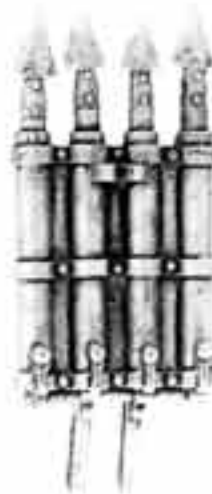

SPEARGUN GUN
040301503



SPEARGUN GUN SUPPORT BASE
040301507



SPEARGUN GUN MOUNT
040301508



SPEARGUN SPEARS
040301505



SPEARGUN GANG PLANK BASE
040301513



SPEARGUN DRIVER
040301511



SPEARGUN HANDLE
040301510



SPEARGUN SPANNER
040301512

A COMPLETE SPEARGUN WAR TRUKK CONSISTS OF:

- 1 x SPEARGUN GANG PLANK
- 1 x SPEARGUN GANG PLANK WINCH
- 1 x SPEARGUN FRONT PLATE
- 1 x SPEARGUN GLYPHS
- 3 x SPEARGUN SPEARS
- 1 x SPEARGUN GUN
- 1 x SPEARGUN GUN MOUNT
- 1 x SPEARGUN GUN SUPPORT BASE
- 1 x SPEARGUN GANG PLANK BASE
- 1 x SPEARGUN DRIVER
- 1 x SPEARGUN HANDLE
- 1 x SPEARGUN SPANNER
- 1 x PLASTIC WAR TRUKK SPRUE
- 2 x SMALL PLASTIC WHEELS
- 2 x LARGE PLASTIC WHEELS



CITADEL
MINIATURES



CITADEL
MINIATURES

GORKAMORKA™

ROKKIT BUGGY

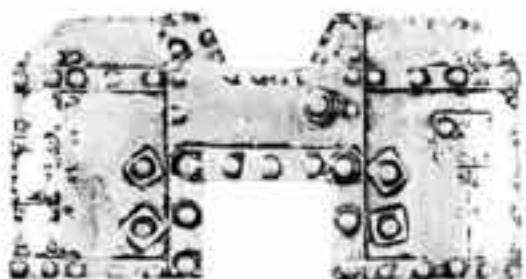

ROKKIT BUGGY
FRONT PLATE
040301401

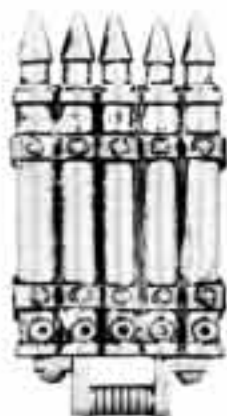

ROKKIT BUGGY
ROKKIT LAUNCHER
040301403



ROKKIT BUGGY
BATTERING RAM
040301402



ROKKIT BUGGY
PINTLE
040301411



ROKKIT BUGGY
GUNNER
040301405



ROKKIT BUGGY



ROKKIT BUGGY
LEFT SUPPORT
040301407



ROKKIT BUGGY
RIGHT SUPPORT
040301406



ROKKIT BUGGY
SPARE ROKKITS
040301409

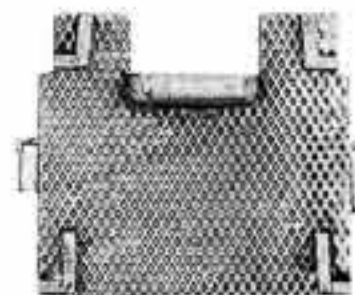

ROKKIT BUGGY
GUNNERS PLATFORM
040301404



ROKKIT BUGGY
MAIN SUPPORT
040301410



ROKKIT BUGGY
BANNER TOP
040301408

A COMPLETE ROKKIT BUGGY CONSISTS OF:

- 1 x ROKKIT BUGGY FRONT PLATE
- 1 x ROKKIT BUGGY ROKKIT LAUNCHER
- 1 x ROKKIT BUGGY BATTERING RAM
- 1 x ROKKIT BUGGY PINTLE
- 1 x ROKKIT BUGGY GUNNER
- 1 x ROKKIT BUGGY SPARE ROKKITS
- 1 x ROKKIT BUGGY RIGHT SUPPORT
- 1 x ROKKIT BUGGY LEFT SUPPORT
- 1 x ROKKIT BUGGY MAIN SUPPORT
- 1 x ROKKIT BUGGY GUNNERS PLATFORM
- 1 x ROKKIT BUGGY BANNER TOP
- 1 x WAR BUGGY SPRUE
- 2 x SMALL ORK WAR BUGGY WHEEL SPRUES
- 2 x LARGE ORK WAR BUGGY WHEEL SPRUES



Designed by Norman Swales and Brian Nelson

GORKAMORKA™

HARPOON TRAK



HARPOON TRAK

A COMPLETE HARPOON TRAK CONSISTS OF:

- 1 x HARPOON TRAK GUN
- 1 x HARPOON TRAK GUNNER BODY
- 1 x HARPOON TRAK GUNNER HAND
- 1 x HARPOON TRAK SPARE HARPOONS
- 1 x HARPOON TRAK GLYPHS
- 1 x HARPOON TRAK SPIKE
- 1 x HARPOON TRAK HARPOON GUN MOUNT
- 1 x PLASTIC WAR TRAK SPRUE
- 1 x SMALL PLASTIC WHEEL SPRUE



HARPOON TRAK GUN
040301301



HARPOON TRAK GUNNER BODY
040301304



HARPOON TRAK SPARE HARPOONS
040301302

**HARPOON TRAK
GLYPHS**
040301305



HARPOON TRAK SPIKE 1
040301306



HARPOON TRAK SPIKE 2
040301307



HARPOON TRAK
GUNNER HAND
040301308



HARPOON TRAK
HARPOON GUN MOUNT
040301303

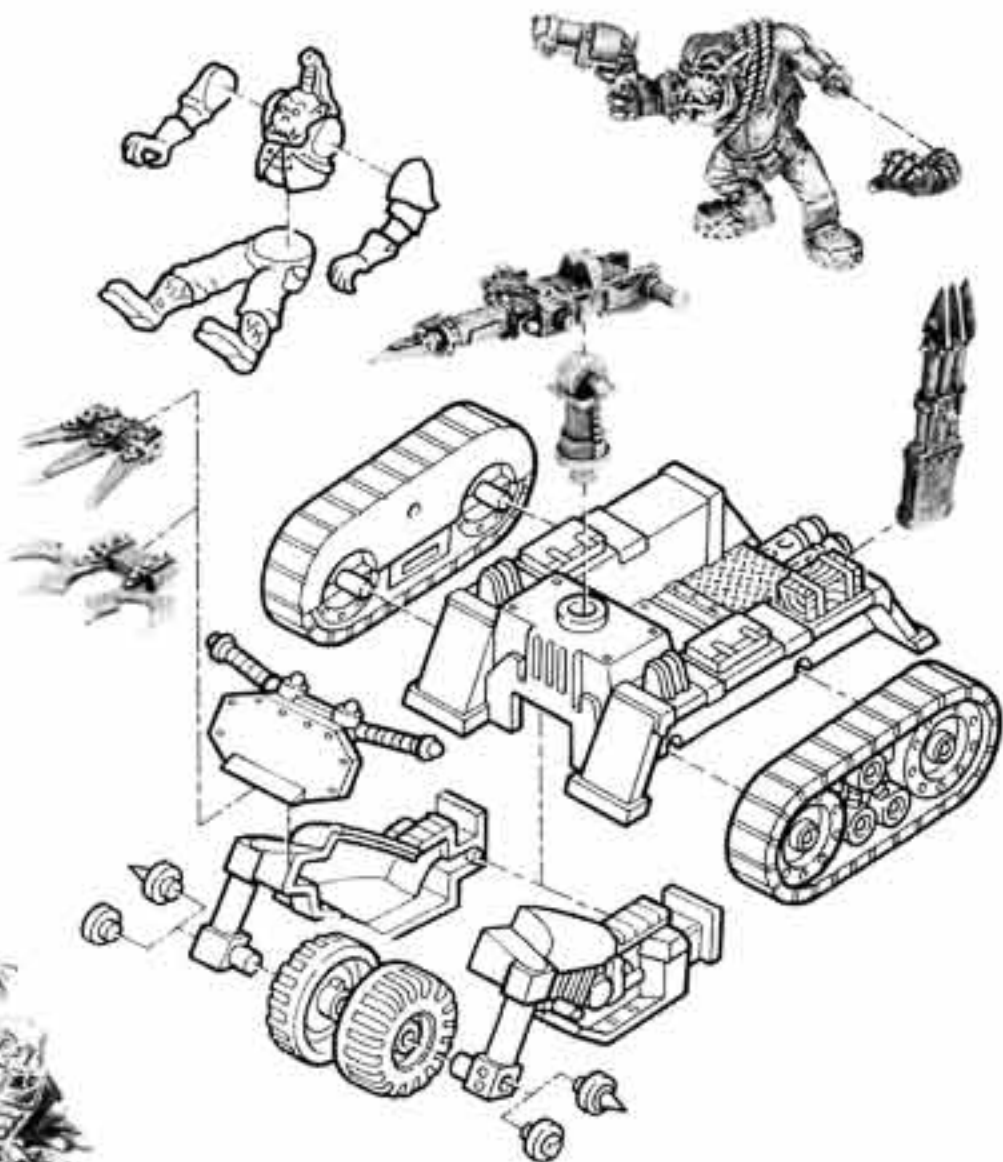

Designed by Norman Swales

GORKAMORKA™

RED GOBBO



RED GOBBO
040302601

HEAD HONCHO



HEAD HONCHO
040302701

THE COMPLETE HEAD HONCHO
CONSISTS OF:
1 x HEAD HONCHO
1 x HEAD HONCHO'S BANNER



HEAD HONCHO'S BANNER
040302702



COMPLETE
HEAD HONCHO

SNOTZ



SNOTZ WITH
BOW 1
040302901



SNOTZ WITH
KNUCKLES AND CLUB
040302902



SNOTZ WITH
CATAPULT
040302903



SNOTZ WITH
BOW 2
040302904



Designed by Brian Nelson

175

Not recommended for children under 8 years due to small parts and essential pointed components. All models supplied unpainted.
© Copyright Games Workshop Ltd. 1998. All rights reserved.

GORKAMORKA™

REBEL GROT BIG LUGGA

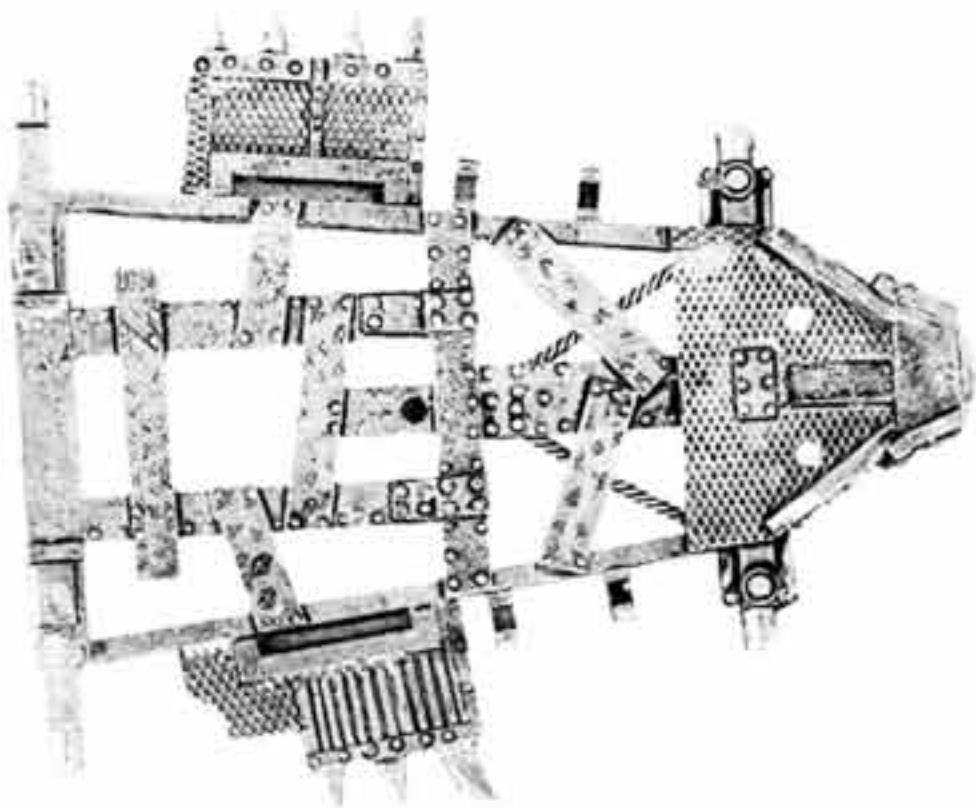

**BIG LUGGA
TOWER LEFT SIDE**
040302403



**BIG LUGGA
TOWER RIGHT SIDE**
040302404



**BIG LUGGA
ROOF**
040302402

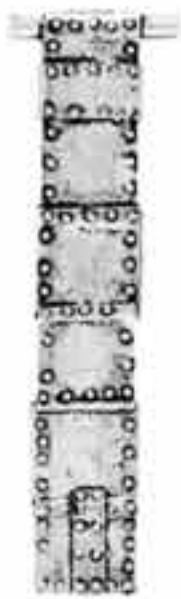

**BIG LUGGA
CHASSIS**
040302401

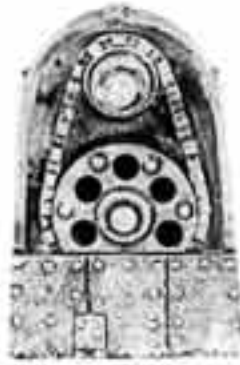

**BIG LUGGA
WORKY BITS**
040302406



**BIG LUGGA
SPLATTAPULT SUPPORT**
040302407

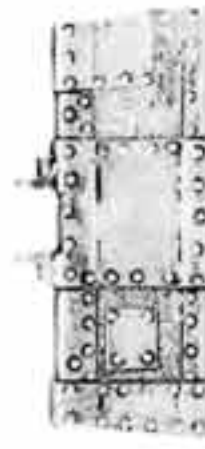

**BIG LUGGA
TOWER PLATFORM**
040302408



**BIG LUGGA
STEERING COLUMN**
040302409



**BIG LUGGA
RAM**
040302410

**BIG LUGGA
BOARDING PLANK**
040302405



**BIG LUGGA
STRUT 1**
040302411



**BIG LUGGA
STRUT 2**
040302412



**BIG LUGGA
SPLATTAPULT**
040302413



**BIG LUGGA
PROPELLER**
040302414



**BIG LUGGA
STEERING COG**
040302415



**BIG LUGGA
CRANK**
040302416



**BIG LUGGA
GROT CAPTAIN**
040302417



**BIG LUGGA
GROT CRANK CREW 1**
040302418



**BIG LUGGA
GROT SPLATTAPULT LOADER**
040302419



**BIG LUGGA
GROT CRANK CREW 2**
040302420



Big Lugga designed by Norman Swales, Grot Crew designed by Brian Nelson

GORKAMORKA™

REBEL GROT BIG LUGGA

- THE REBEL GROT BIG LUGGA
CONSISTS OF:
- 1 x BIG LUGGA CHASSIS
 - 1 x BIG LUGGA ROOF
 - 1 x BIG LUGGA TOWER LEFT SIDE
 - 1 x BIG LUGGA TOWER RIGHT SIDE
 - 2 x BIG LUGGA BOARDING PLANK
 - 1 x BIG LUGGA WORKY BITS
 - 1 x BIG LUGGA SPLATTAPULT SUPPORT
 - 1 x BIG LUGGA TOWER PLATFORM
 - 1 x BIG LUGGA STEERING COLUMN
 - 1 x BIG LUGGA RAM
 - 1 x BIG LUGGA STRUT 1
 - 1 x BIG LUGGA STRUT 2
 - 1 x BIG LUGGA SPLATTAPULT
 - 1 x BIG LUGGA PROPELLER
 - 1 x BIG LUGGA STEERING COG
 - 1 x BIG LUGGA CRANK
 - 1 x BIG LUGGA GROT CAPTAIN
 - 1 x BIG LUGGA GROT CRANK CREW 1
 - 1 x BIG LUGGA GROT SPLATTAPULT LOADER
 - 1 x BIG LUGGA GROT CRANK CREW 2
 - 2 x PLASTIC LARGE TYRED WHEEL
 - 2 x PLASTIC ORK WHEEL

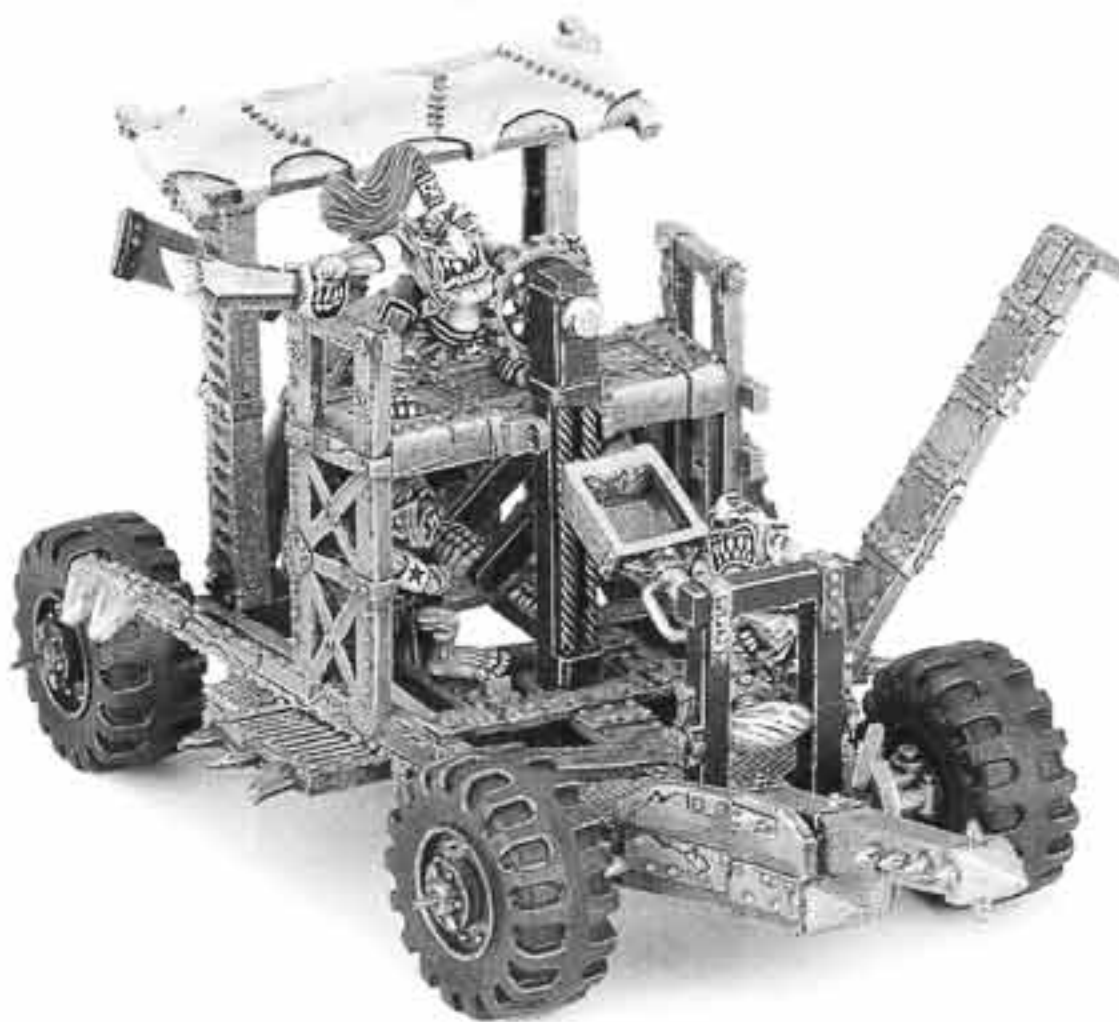

REBEL GROT BIG LUGGA

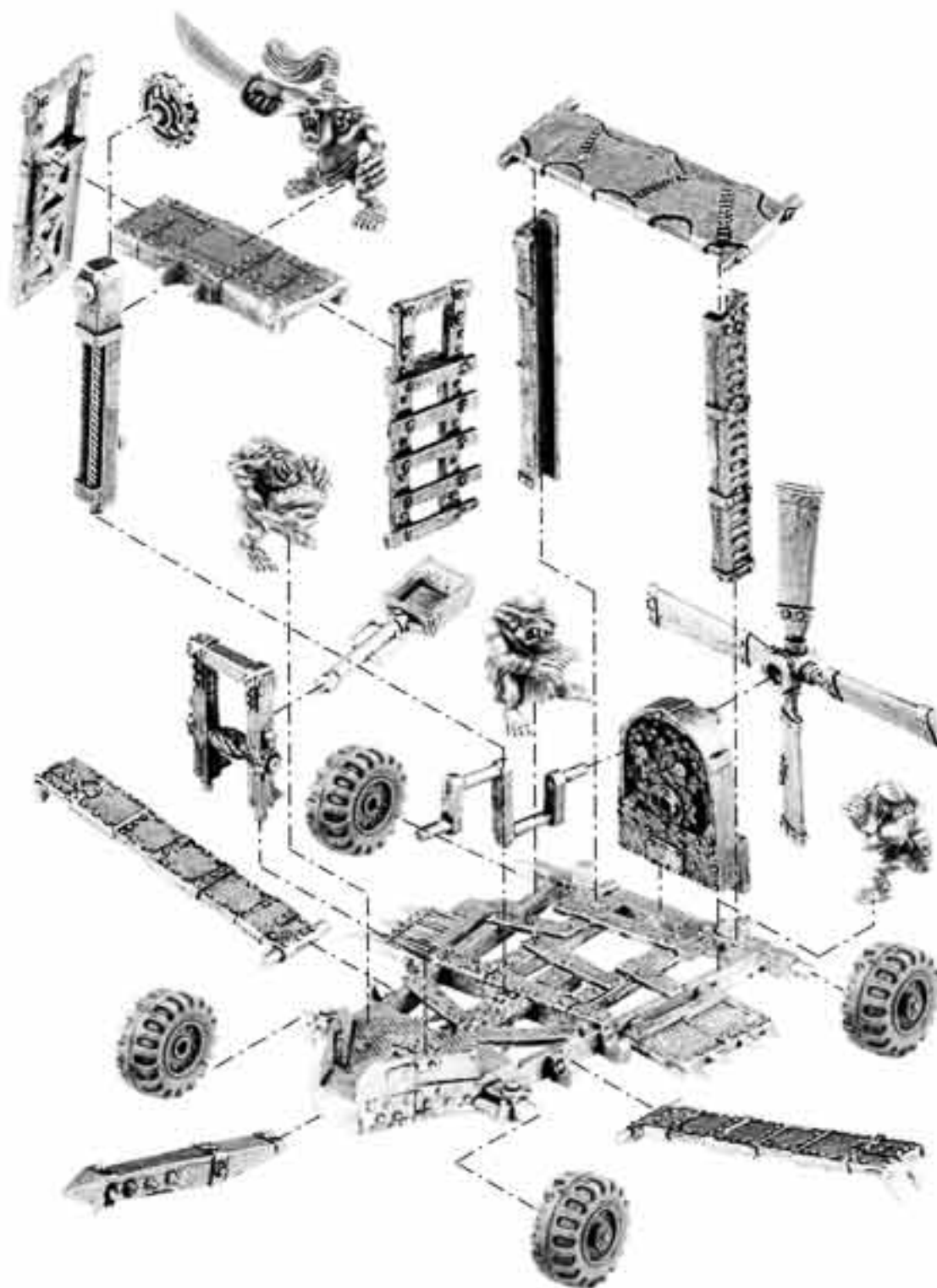

Big Lugga designed by Norman Swales, Grot Crew designed by Brian Nelson

Not recommended for children under 8 years due to small parts and essential pointed components. All models supplied unpainted.
© Copyright Games Workshop Ltd. 1998. All rights reserved.

GORKAMORKA™

REBEL GROT CUTTA



REBEL GROT CUTTA
SAIL SUPPORT
040302501



REBEL GROT CUTTA
MAST
040302502



REBEL GROT CUTTA
STEERING HANDLE
040302504



REBEL GROT CUTTA
COG
040302505



REBEL GROT CUTTA



REBEL GROT CUTTA
CHASSIS
040302503

- THE COMPLETE
REBEL GROT CUTTA
CONSISTS OF:
- 1 x REBEL GROT CUTTA SAIL SUPPORT
 - 1 x REBEL GROT CUTTA MAST
 - 1 x REBEL GROT CUTTA CHASSIS
 - 1 x REBEL GROT CUTTA STEERING HANDLE
 - 1 x REBEL GROT CUTTA COG
 - 1 x REBEL GROT CUTTA CROWS NEST
 - 1 x REBEL GROT CUTTA PILOT
 - 1 x REBEL GROT CUTTA LOOKOUT
 - 1 x REBEL GROT CUTTA WHEEL AXLE
 - 2 x PLASTIC LARGE TYRED WHEEL SPRUES
 - 1 x PLASTIC IRON WHEEL



REBEL GROT CUTTA
PILOT
040302507



REBEL GROT CUTTA
WHEEL AXLE
040302509



REBEL GROT CUTTA
LOOKOUT
040302508



REBEL GROT CUTTA
CROWS NEST
040302506

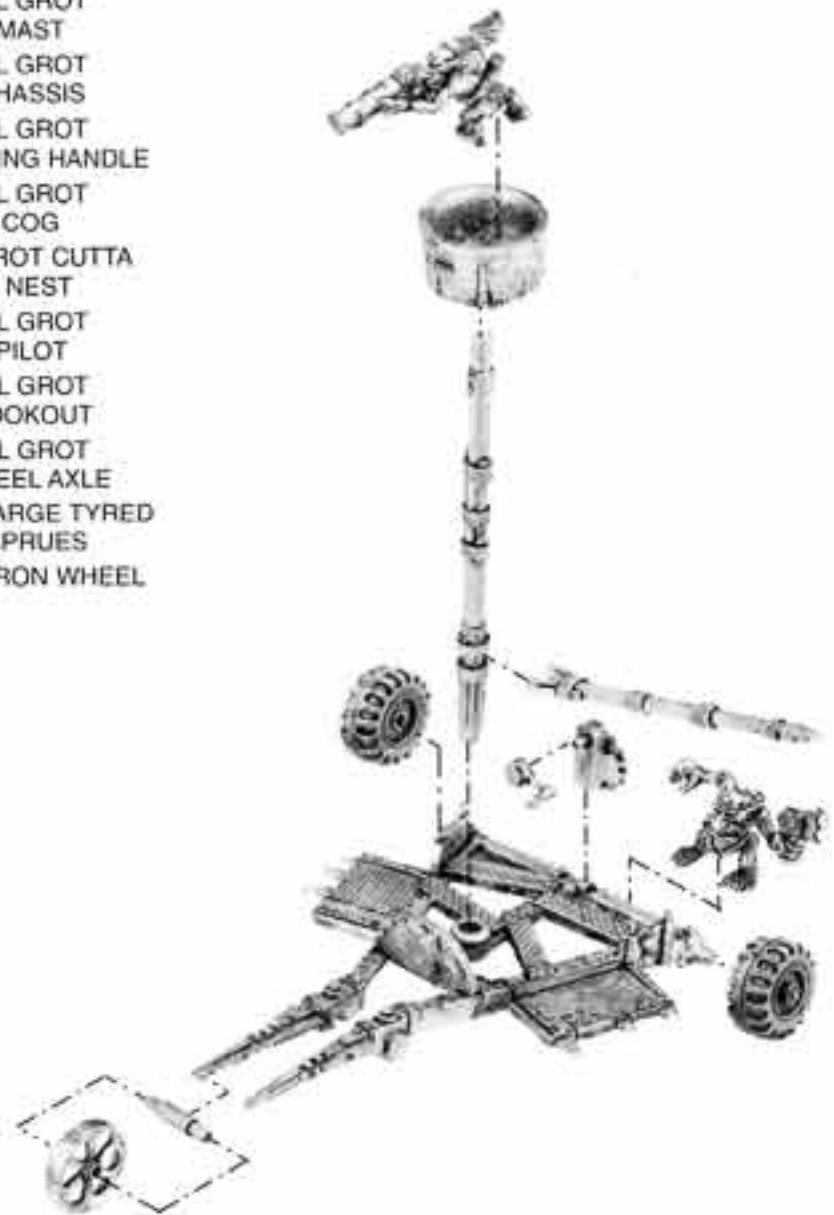

Rebel Cutta designed by Norman Swales, Grot Crew designed by Brian Nelson

GORKAMORKA™

MUTIE RAIDERS



MUTIE RIDING BEAST 1
RIGHT SIDE
040900701



MUTIE RIDING BEAST 1
LEFT SIDE
040900702



BEAST HEAD 1
040900709



BEAST HEAD 2
040900711



MUTIE RIDING BEAST 2
RIGHT SIDE
040900703



MUTIE RIDING BEAST 2
LEFT SIDE
040900704



BEAST TAIL 2
040900712



BEAST TAIL 1
040900710



MUTIE RIDING BEAST 3
RIGHT SIDE
040900705



MUTIE RIDING BEAST 3
LEFT SIDE
040900706



MUTIE RAIDER
EQUIPMENT SPRUE 2
040900714



MUTIE RAIDER
EQUIPMENT SPRUE 1
040900713



MUTIE RIDING BEAST 4
RIGHT SIDE
040900707



MUTIE RIDING BEAST 4
LEFT SIDE
040900708

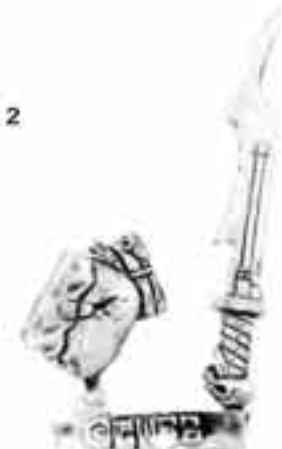

MUTIE RAIDER
EQUIPMENT SPRUE 3
040900715



Designed by Paul Muller and Trish Morrison

Not recommended for children under 8 years due to small parts and essential pointed components. All models supplied unpainted.
© Copyright Games Workshop Ltd. 1998. All rights reserved.

GORKAMORKA™

MUTIE RAIDERS



SNAGA MUTIE
TORSO WITH ARBALAST
040900722



SNAGA MUTIE
TORSO WITH CAVALIER
040900721



UNK MUTIE
TORSO WITH GLAIVE
040900724



KEEPER MUTIE
TORSO
040900717



UNK MUTIE
TORSO WITH DEMILUME
040900725



EXAMPLE OF COMPLETED
SEEKER MUTIE



SNAGA/KEEPER MUTIE
LEGS
040900716

A COMPLETE MUTIE RAIDER
CONSISTS OF:
1 x MUTIE RIDING BEAST RIGHT SIDE
1 x MUTIE RIDING BEAST LEFT SIDE
1 x ACCESSORY SPRUE
1 x TORSO
1 x LEGS
1 x BEAST'S HEAD
1 x TAIL



UNK MUTIE
LEGS
040901023



SEEKER MUTIE
TORSO WITH JEZZAIL
040900719



EXAMPLE OF COMPLETED
UNK MUTIE



SEEKER MUTIE
LEGS
040900718



EXAMPLE OF COMPLETED
KEEPER MUTIE



EXAMPLE OF COMPLETED
SNAGA MUTIE



Designed by Paul Muller and Trish Morrison

GORKAMORKA™

DIGGANOB



DIGGANOB BODY
040900201

THE COMPLETE DIGGANOB
CONSISTS OF:
1 x DIGGANOB BODY
1 x DIGGANOB KANNON ARM
1 x DIGGANOB BANNERPOLE



DIGGANOB



DIGGANOB KANNON ARM
040900202



DIGGANOB BANNERPOLE
040900203

DIGGA SHAMAN



DIGGA SHAMAN
040900501



NAZGRUB WURRZAG – SCRAP PROSPECTOR



NAZGRUB WURRZAG'S
BODY
040302201



NAZGRUB WURRZAG'S
BACKPACK
040302204



NAZGRUB WURRZAG'S
HEAD
040302202



NAZGRUB WURRZAG'S
KANNON ARM
040302203

A COMPLETE NAZGRUB
WURRZAG CONSISTS OF:
1 x NAZGRUB WURRZAG'S
BODY
1 x NAZGRUB WURRZAG'S
BACKPACK
1 x NAZGRUB WURRZAG'S
HEAD
1 x NAZGRUB WURRZAG'S
KANNON ARM



NAZGRUB WURRZAG



CITADEL
MINIATURES



CITADEL
MINIATURES

Diggas designed by Paul Muller. Nazgrub designed by Brian Nelson

Not suitable for children under 8 years due to small parts and essential pointed components. All models supplied unpainted.
© Copyright Games Workshop Ltd. 1998. All rights reserved.

GORKAMORKA™

DIGGA BOYZ



DIGGA BOY WITH
SIX-SHOOTA
040900301



DIGGA BOY WITH
SHOOTER
040900305



DIGGA BOY WITH
KANNON
040900304



DIGGA BOY WITH
SLUGGA
040900303



DIGGA BOY WITH
BLUNDERBUSS
040900302

DIGGA YOOFs



DIGGA YOOF WITH
SLUGGA 1
040900401



DIGGA YOOF WITH
BLUNDERBUSS
040900402



DIGGA YOOF WITH
SIX-SHOOTA
040900403



DIGGA YOOF WITH
SLUGGA 2
040900404

Designed by Paul Muller



GORKAMORKA™

DIGGA TRUKK

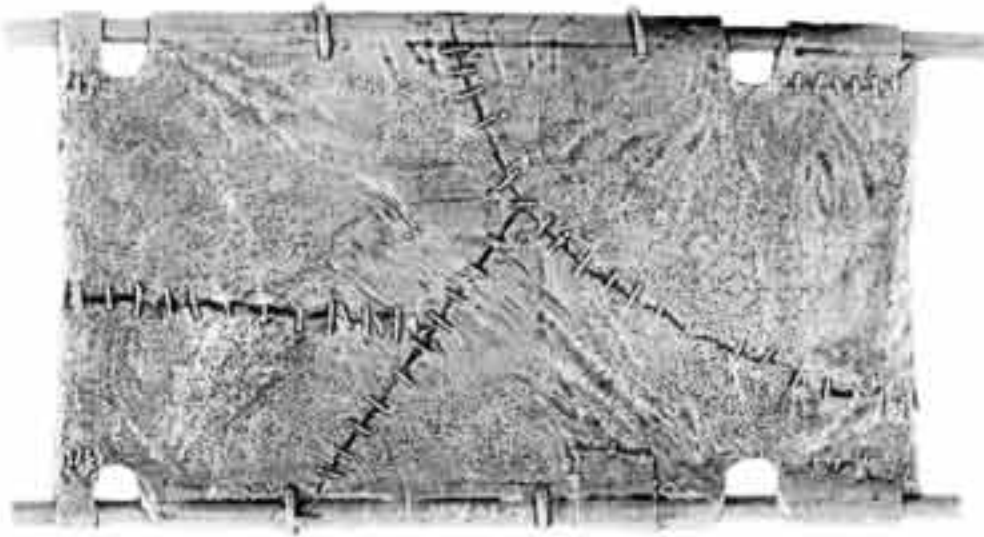

DIGGA TRUKK ROOF
040900101

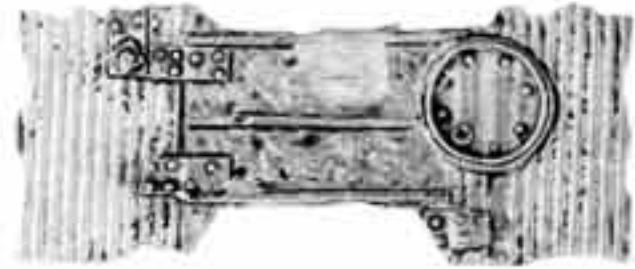

DIGGA TRUKK FRONT PLATE 1
040900102



DIGGA TRUKK FRONT PLATE 2
040900103



DIGGA TRUKK RAM
040900104

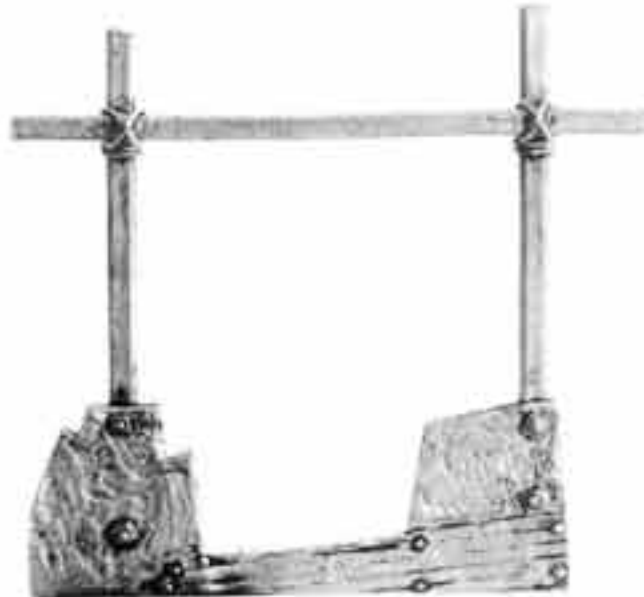

DIGGA TRUKK FRONT ROOF SUPPORT
040900105



DIGGA TRUKK BACK ROOF SUPPORT
040900106



DIGGA TRUKK CREW LEGS
040900107



DIGGA TRUKK GUNNER TORSO
040900108



DIGGA TRUKK GUNNER ARMS
040900109



DIGGA TRUKK DRIVER TORSO
040900110



DIGGA TRUKK DRIVER ARMS
040900111

THE COMPLETE DIGGA TRUKK CONSISTS OF:

- 1 x DIGGA TRUKK ROOF
- 1 x DIGGA TRUKK FRONT PLATE 1 OR 2
- 1 x DIGGA TRUKK FRONT ROOF SUPPORT
- 1 x DIGGA TRUKK BACK ROOF SUPPORT
- 1 x DIGGA TRUKK RAM
- 2 x DIGGA TRUKK CREW LEGS
- 1 x DIGGA TRUKK GUNNER TORSO
- 1 x DIGGA TRUKK GUNNER ARMS
- 1 x DIGGA TRUKK DRIVER TORSO
- 1 x DIGGA TRUKK DRIVER ARMS
- 1 x PLASTIC WAR TRUKK SPRUE
- 2 x SMALL PLASTIC WHEELS
- 2 x LARGE PLASTIC WHEELS



DIGGA TRUKK



Designed by Norman Swales and Paul Muller

Not suitable for children under 8 years due to small parts and essential pointed components. All models supplied unpainted.
© Copyright Games Workshop Ltd. 1998. All rights reserved.

NECROMUNDA™



NECROMUNDA™

HOUSE ORLOCK LEADERS



ORLOCK LEADER WITH
MELTA-GUN AND LASPISTOL
059905723



ORLOCK LEADER WITH
BOLTGUN AND AXE
059900207

HOUSE ORLOCK HEAVIES

A COMPLETE ORLOCK
HEAVY CONSISTS OF:
1x ORLOCK HEAVY BODY
1x HEAVY WEAPON
1x HEAVY BACKPACK



ORLOCK
HEAVY BOLTER BODY
059905513



ORLOCK
HEAVY BOLTER
059905514



ORLOCK HEAVY
WITH HEAVY BOLTER



ORLOCK HEAVY STUBBER
059900209



ORLOCK HEAVY
STUBBER BACKPACK
059900210



ORLOCK HEAVY
BOLTER BACKPACK
059905515



ORLOCK FLAMER
BACKPACK
059905518



ORLOCK FLAMER
059905517



ORLOCK HEAVY
STUBBER BODY
059900208



ORLOCK HEAVY
WITH HEAVY STUBBER



ORLOCK FLAMER BODY
059905516



ORLOCK HEAVY WITH FLAMER

HOUSE ORLOCK GANGERS



ORLOCK WITH LASGUN 1
059905622



ORLOCK WITH AUTOGUN 1
059900202



ORLOCK WITH AUTOGUN AND STUB GUN
059905621



ORLOCK WITH LASGUN 2
059900201



ORLOCK WITH SHOTGUN
059900204



ORLOCK WITH AUTOGUN 2
059905619



ORLOCK WITH STUB GUN AND PICK
059905620



ORLOCK WITH AUTOPISTOL
059900203



Designed by Michael Perry

Not suitable for children under 36 months due to small parts and essential pointed components. All models supplied unpainted.
© Copyright Games Workshop Ltd., 1997. All rights reserved.

NECROMUNDA™

HOUSE ORLOCK JUVES



ORLOCK JUVE
WITH STUB GUN AND CLUB
059905412



ORLOCK JUVE WITH
AUTOPISTOL
059900205



ORLOCK JUVE WITH
STUB GUN
059900206



ORLOCK JUVE WITH
LASPISTOL
059905411

HOUSE DELAQUE LEADER



DELAQUE LEADER
WITH BOLTGUN
059900610



DELAQUE HEAVY
STUBBER BODY
059900607



DELAQUE HEAVY
STUBBER PACK
059900609



DELAQUE HEAVY STUBBER
059900608

A COMPLETE DELAQUE HEAVY WITH HEAVY STUBBER

CONSISTS OF:
1 x DELAQUE HEAVY STUBBER BODY
1 x DELAQUE HEAVY STUBBER
1 x HEAVY DELAQUE STUBBER BACKPACK



DELAQUE HEAVY
WITH HEAVY STUBBER

HOUSE DELAQUE GANGERS



DELAQUE WITH LASGUN 1
059900604



DELAQUE WITH SHOTGUN 1
059900605



DELAQUE WITH AUTOGUN 1
059900606



DELAQUE WITH LASGUN 2
059900603

HOUSE DELAQUE JUVES



DELAQUE JUVE WITH STUB GUN 1
059900601



DELAQUE JUVE WITH AUTOPISTOL 1
059900602



DELAQUE JUVE WITH STUB GUNS
059902112



DELAQUE JUVE WITH STUB GUN 2
059902111

Delaque designed by Alan Perry, Orlock Juves designed by Michael Perry

NECROMUNDA™

HOUSE DELAQUE LEADER



DELAQUE LEADER WITH
BOLTGUN AND POWER AXE
059902417

HOUSE DELAQUE HEAVIES

A COMPLETE DELAQUE HEAVY
WITH FLAMER
CONSISTS OF:
1 x DELAQUE FLAMER BODY
1 x DELAQUE FLAMER PACK



DELAQUE
FLAMER BODY
059902213



DELAQUE
FLAMER PACK
059902214



DELAQUE HEAVY
WITH FLAMER



DELAQUE
LASCANNON BODY
059902220



DELAQUE
LASCANNON PACK
059902222



DELAQUE LASCANNON
059902221



DELAQUE HEAVY
WITH LASCANNON

A COMPLETE DELAQUE HEAVY
WITH LASCANNON
CONSISTS OF:
1 x DELAQUE LASCANNON BODY
1 x DELAQUE LASCANNON PACK
1x DELAQUE LASCANNON

HOUSE DELAQUE GANGERS



DELAQUE WITH AUTOGUN 2
059902319



DELAQUE WITH LASGUN 3
059902315



DELAQUE WITH LASGUN 4
059902316



DELAQUE WITH SHOTGUN 2
059902318



NECROMUNDA™

HOUSE CAWDOR LEADERS



CAWDOR LEADER WITH
AUTOPISTOL AND CHAINSWORD
059900111



CAWDOR LEADER WITH
BOLTGUN AND POWER SWORD
059906121

HOUSE CAWDOR GANGERS



CAWDOR
WITH SHOTGUN 1
059900104



CAWDOR
WITH SHOTGUN 2
059906020



CAWDOR
WITH AUTOGUN 1
059900101



CAWDOR
WITH LASGUN 1
059906018



CAWDOR
WITH LASGUN 2
059906019



CAWDOR
WITH LASGUN 3
059900103



CAWDOR
WITH AUTOGUN 2
059906017



CAWDOR
WITH LASGUN 4
059900102

HOUSE CAWDOR HEAVIES



CAWDOR
HEAVY STUBBER BODY
059900107



CAWDOR HEAVY
STUBBER BACKPACK
059900109



CAWDOR HEAVY STUBBER
059900108

A COMPLETE CAWDOR
HEAVY CONSISTS OF:
1x CAWDOR HEAVY BODY
1x HEAVY WEAPON
1x HEAVY BACKPACK



CAWDOR HEAVY BOLTER
059905923



CAWDOR HEAVY
BACKPACK
059905916



CAWDOR GRENADE LAUNCHER
059905915



CAWDOR HEAVY
WITH HEAVY STUBBER



CAWDOR HEAVY
BOLTER BODY
059905922



CAWDOR HEAVY
WITH HEAVY BOLTER



CAWDOR GRENADE
LAUNCHER BODY
059905914



CAWDOR HEAVY
WITH GRENADE LAUNCHER

HOUSE CAWDOR JUVES



CAWDOR JUVE
WITH STUB GUN 1
059900106



CAWDOR JUVE WITH
STUB GUN 2
059905812



CAWDOR JUVE WITH
LASPISTOL
059905813



CAWDOR JUVE WITH
STUB GUN 3
059900105



NECROMUNDA™

HOUSE GOLIATH LEADER



GOLIATH LEADER WITH CHAINWORD
AND GRENADE LAUNCHER
059900310

HOUSE GOLIATH JUVES



GOLIATH JUVE WITH LASPISTOL 1
059900302



GOLIATH JUVE WITH STUB GUN
059900301

HOUSE GOLIATH GANGERS



GOLIATH WITH
HAND FLAMER
059900306



GOLIATH WITH LASGUN
AND AUTOPISTOL
059901116



GOLIATH WITH
AUTOGUN AND AXE
059901117



GOLIATH WITH AUTOGUN
059900303



GOLIATH WITH LASGUN
AND STUB GUN
059900305



GOLIATH WITH SHOTGUN
059900304

HOUSE GOLIATH HEAVY



GOLIATH HEAVY
STUBBER BODY
059900307

A COMPLETE GOLIATH HEAVY
CONSISTS OF:
1 x GOLIATH HEAVY BODY
1 x GOLIATH HEAVY BACKPACK
1 x GOLIATH HEAVY STUBBER



GOLIATH HEAVY STUBBER
059900308



GOLIATH HEAVY
STUBBER BACKPACK
059900309



GOLIATH HEAVY
WITH HEAVY STUBBER



Designed by Gary Morley

NECROMUNDA™

HOUSE GOLIATH LEADER



GOLIATH LEADER WITH
MELTAGUN AND STUB GUN
059901218

HOUSE GOLIATH JUVES



GOLIATH JUVE
WITH LASPISTOL 2
059906211



GOLIATH JUVE
WITH AUTOPISTOL
059906212

HOUSE GOLIATH HEAVY



GOLIATH HEAVY
BOLTER BODY
059901013

A COMPLETE GOLIATH HEAVY
CONSISTS OF:

- 1 x GOLIATH HEAVY BODY
- 1 x GOLIATH HEAVY BACKPACK
- 1 x GOLIATH HEAVY BOLTER



GOLIATH HEAVY BOLTER
059901014



GOLIATH HEAVY
BOLTER BACK PACK
059901015



GOLIATH HEAVY
WITH HEAVY BOLTER

Designed by Gary Morley



CITADEL
MINIATURES



CITADEL
MINIATURES

NECROMUNDA™

HOUSE ESCHER LEADERS



ESCHER LEADER WITH BOLT GUN
AND LASPISTOL
059900410



ESCHER LEADER WITH AUTOPISTOL
AND POWER SWORD
059901627



HOUSE ESCHER JUVES



ESCHER JUVE WITH
STUB GUN AND PICK
059900405



ESCHER JUVE WITH
AUTOPISTOL
059900406



ESCHER JUVE WITH
STUB GUN
059901311



ESCHER JUVE WITH
AUTOPISTOL AND CLUB
059901312

HOUSE ESCHER GANGERS



ESCHER WITH AUTOGUN
AND STUB GUN
059900403



ESCHER WITH LASGUN 1
059900401



ESCHER WITH AUTOPISTOL
AND SWORD
059900402



ESCHER WITH SHOTGUN
059900404

HOUSE ESCHER HEAVY



ESCHER HEAVY
STUBBER BODY
059900407

A COMPLETE ESCHER HEAVY
CONSISTS OF:
1 x ESCHER HEAVY STUBBER BODY
1 x HEAVY STUBBER BACKPACK
1 x ESCHER HEAVY STUBBER

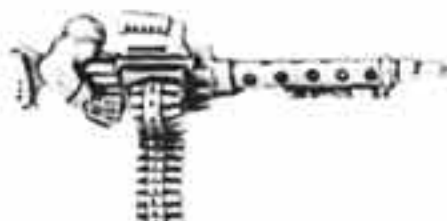

ESCHER HEAVY STUBBER
059900408



ESCHER HEAVY
STUBBER BACKPACK
059900409



HOUSE ESCHER HEAVY
WITH HEAVY STUBBER



Designed by Jes Goodwin

191

Not suitable for children under 36 months due to small parts and essential pointed components. All models supplied unpainted.
© Copyright Games Workshop Ltd., 1997. All rights reserved.

NECROMUNDA™

HOUSE ESCHER GANGERS



ESCHER WITH
LASGUN 2
059901520



ESCHER WITH
TWO SWORDS
059901524



ESCHER WITH SHOTGUN
AND AUTO PISTOL
059901522



ESCHER WITH PLASMA
PISTOL AND CLUB
059901519



ESCHER WITH
LASPISTOL AND FLAIL
059901525



ESCHER WITH
AUTOGUN
059901521



ESCHER WITH
AUTO PISTOL AND CHAINWORD
059901526



ESCHER WITH
BOLT PISTOL AND GRENADE
059901523

HOUSE ESCHER HEAVY



ESCHER HEAVY PLASMA
GUN BACKPACK
059901415



ESCHER HEAVY PLASMA GUN
059901414



ESCHER HEAVY
PLASMA GUN BODY
059901413



HOUSE ESCHER HEAVY
WITH HEAVY PLASMA GUN

A COMPLETE ESCHER HEAVY
CONSISTS OF:
1 x ESCHER HEAVY
PLASMA GUN BODY
1 x ESCHER HEAVY
PLASMA GUN BACKPACK
1 x ESCHER HEAVY
PLASMA GUN



NECROMUNDA™

HOUSE VAN SAAR LEADER



VAN SAAR LEADER WITH
PLASMA PISTOL AND CHAINSWORD
059905010

HOUSE VAN SAAR JUVES



VAN SAAR JUVE
WITH LASPSITOL
059900505



VAN SAAR JUVE
WITH AUTOPISTOL AND STUBGUN
059900506

HOUSE VAN SAAR GANGERS



VAN SAAR
WITH LASGUN
059900502



VAN SAAR
WITH SHOTGUN
059900501



VAN SAAR WITH
AUTOGUN AND LASPISTOL
059900503



VAN SAAR
WITH AUTOGUN
059900504

HOUSE VAN SAAR HEAVIES



VAN SAAR HEAVY
STUBBER BODY
059900507



VAN SAAR HEAVY
STUBBER PACK
059900509



VAN SAAR HEAVY STUBBER
059900508



VAN SAAR HEAVY
WITH HEAVY STUBBER

A COMPLETE VAN SAAR HEAVY WITH
HEAVY STUBBER CONSISTS OF:
1 x VAN SAAR HEAVY STUBBER BODY
1 x VAN SAAR HEAVY STUBBER
1 x VAN SAAR HEAVY STUBBER PACK



VAN SAAR HEAVY
PLASMA GUN BODY
059901813



VAN SAAR HEAVY
PLASMA GUN BACK PACK
059901815



VAN SAAR HEAVY PLASMA GUN
059901814



VAN SAAR HEAVY
WITH HEAVY PLASMA GUN

A COMPLETE VAN SAAR HEAVY WITH
HEAVY PLASMA GUN CONSISTS OF:
1 x VAN SAAR HEAVY PLASMA GUN BODY
1 x VAN SAAR HEAVY PLASMA GUN
1 x VAN SAAR HEAVY PLASMA GUN PACK



Designed by Gary Morley

NECROMUNDA™

HOUSE VAN SAAR LEADER



VAN SAAR LEADER WITH
MELTA-GUN AND CHAINWORD
059902023

HOUSE VAN SAAR JUVES



VAN SAAR JUVE
WITH AUTOPISTOL
059901711



VAN SAAR JUVE
WITH STUB GUN AND CLUB
059901712

HOUSE VAN SAAR GANGERS



VAN SAAR
WITH LASGUN AND AUTOPISTOL
059901919



VAN SAAR
WITH BOLTGUN
059901920

Designed by Gary Morley



CITADEL
MINIATURES



CITADEL
MINIATURES

NECROMUNDA™

NECROMUNDA BULKHEADS

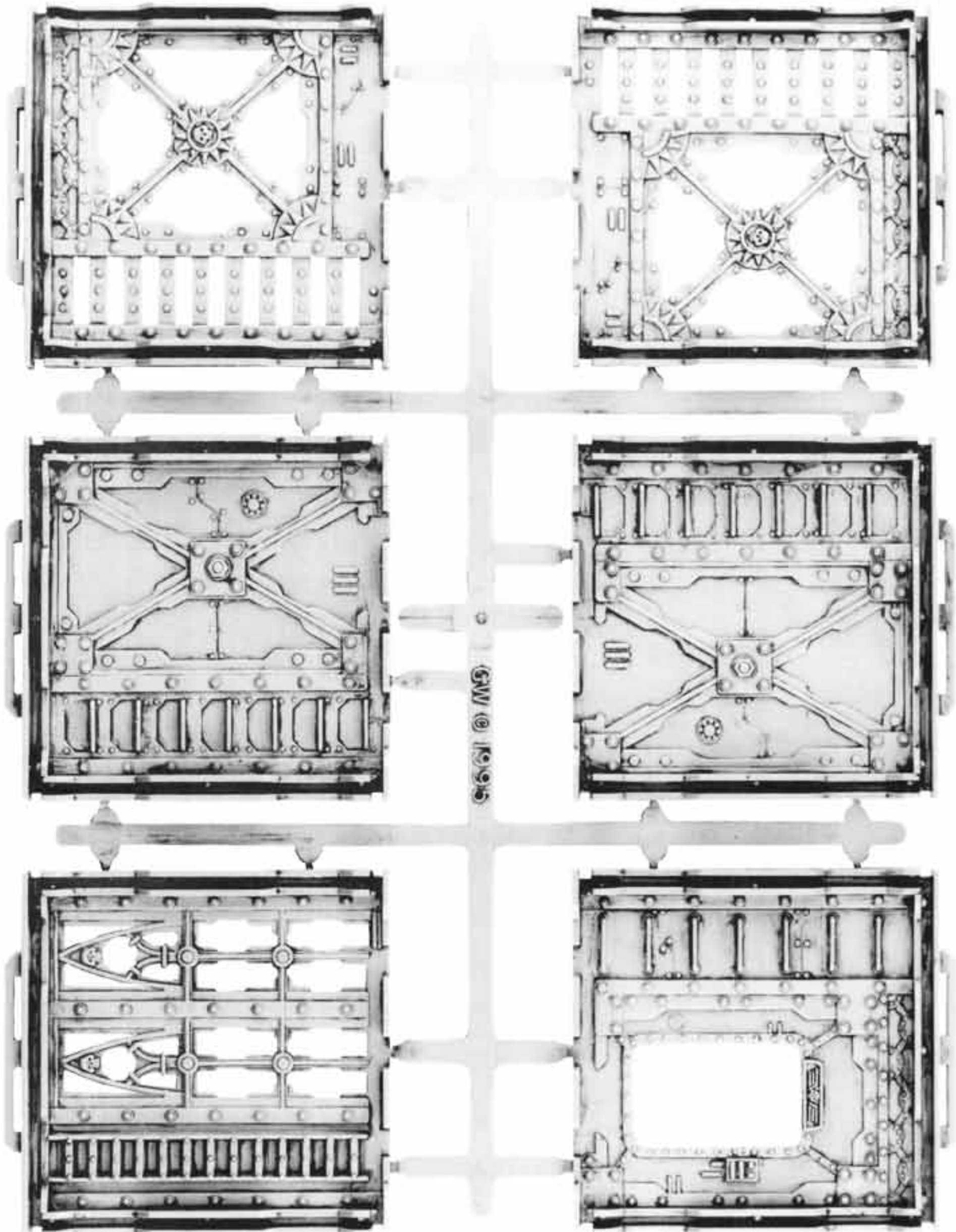

NECROMUNDA BULKHEAD SPRUE
(SHOWN AT 85% OF ACTUAL SIZE)
102741



NECROMUNDA™

HOUSE ORLOCK PLASTICS

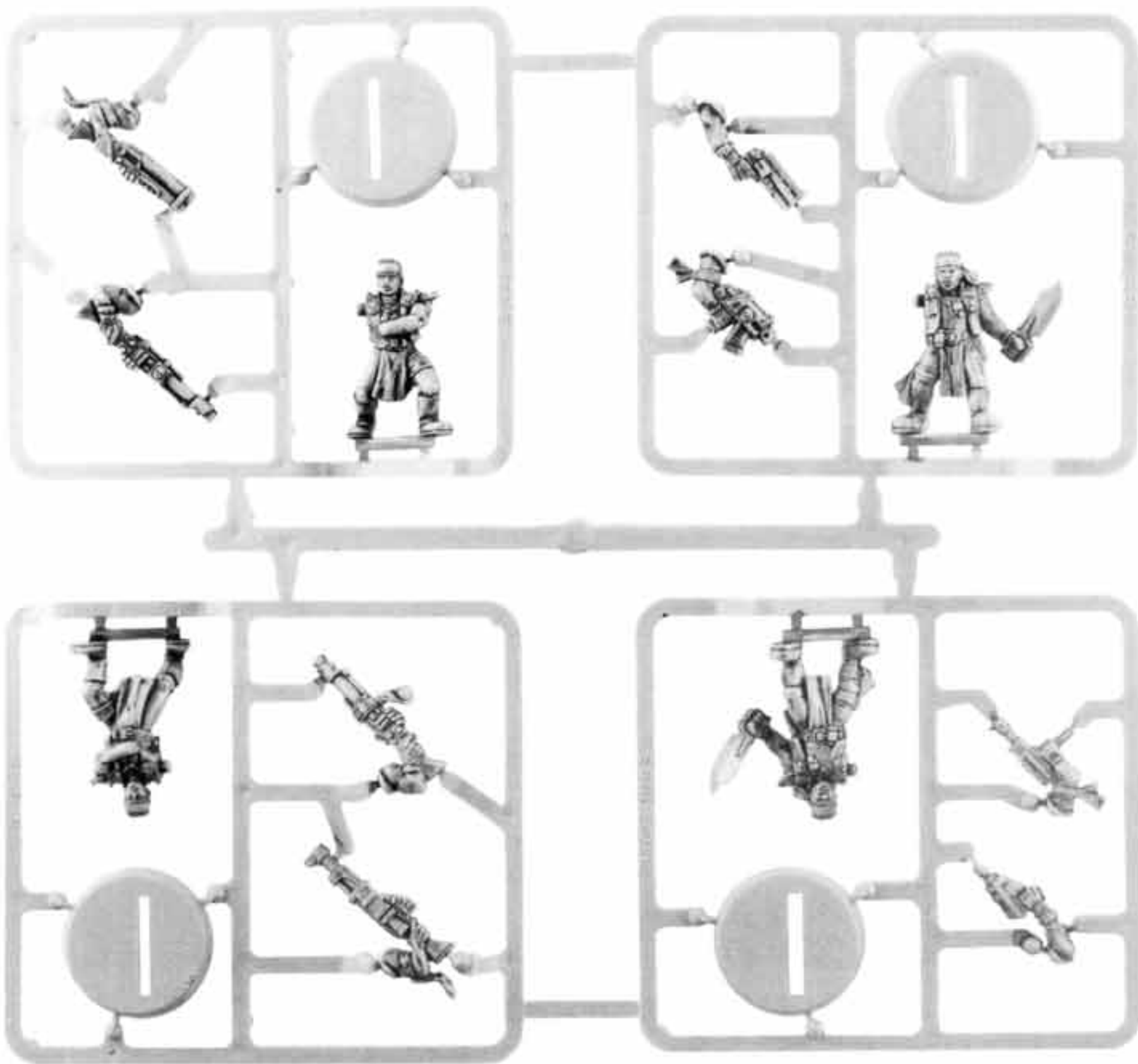

PLASTIC HOUSE ORLOCK SPRUE (SHOWN AT 85% OF ACTUAL SIZE)
102739



PLASTIC ORLOCK GANGER
ARMED WITH A STUBGUN
AND KNIFE



PLASTIC ORLOCK GANGER
ARMED WITH A LASGUN



Designed by Michael and Alan Perry

NECROMUNDA™

PISTOL WEAPON SPRUE



CLOSE COMBAT AND PISTOL SPRUE
059903501



BASIC WEAPON SPRUE



BASIC WEAPON SPRUE
059903502

SPACE MARINE CLOSE COMBAT WEAPON SPRUE



PLASTIC CLOSE COMBAT SPRUE
103437



THE NECROMUNDA WEAPONS BLISTER PACK CONTAINS:
1 x PISTOL WEAPON SPRUE
1 x BASIC WEAPON SPRUE
1 x SPACE MARINE CLOSE COMBAT
WEAPON SPRUE



NECROMUNDA™

HOUSE GOLIATH PLASTICS

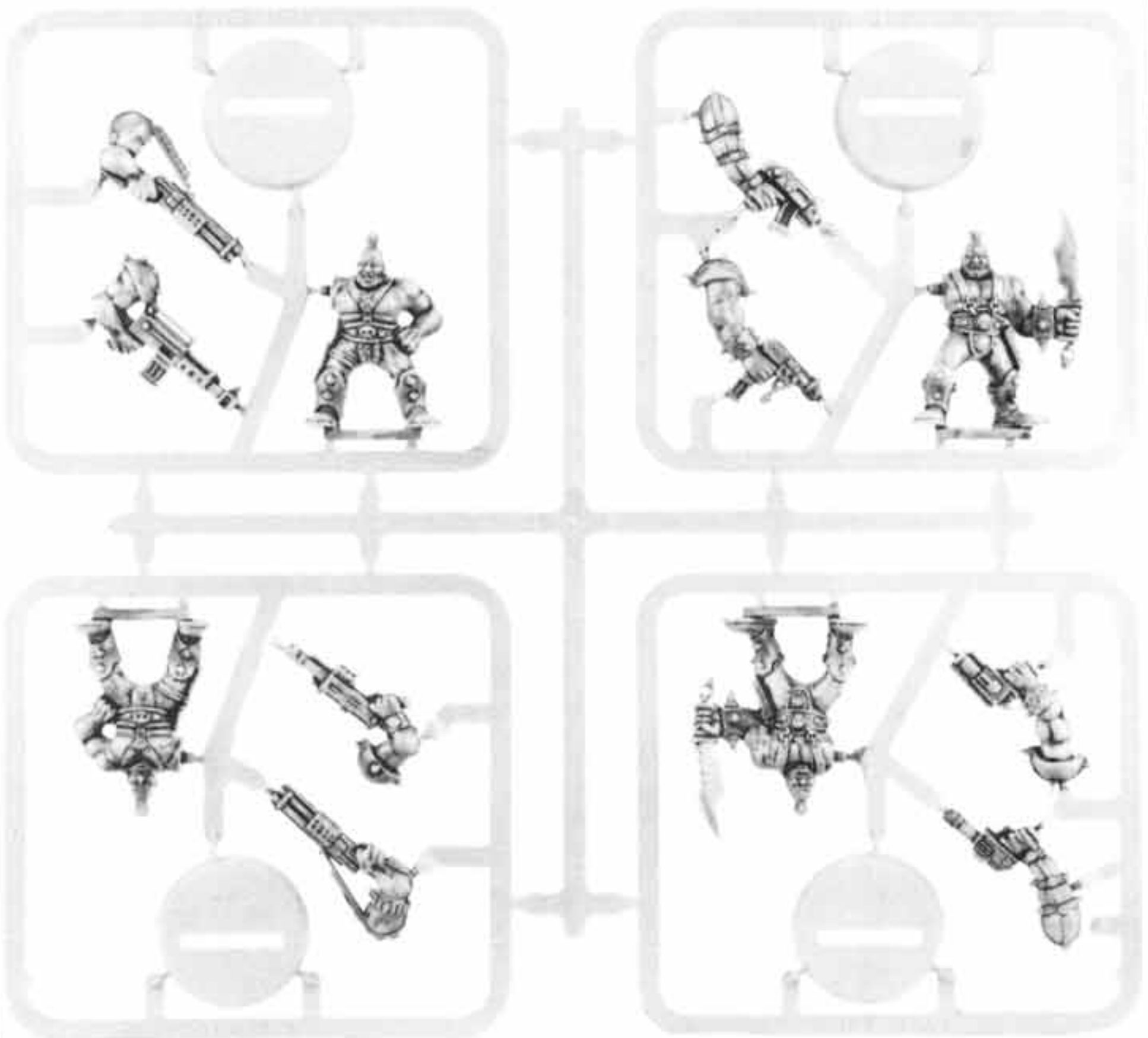

PLASTIC HOUSE GOLIATH SPRUE (SHOWN AT 90% OF ACTUAL SIZE)
102740



PLASTIC GOLIATH GANGER
ARMED WITH AN AUTOPISTOL
AND SWORD



PLASTIC GOLIATH GANGER
ARMED WITH AN AUTOGUN



Designed by Gary Morley

NECROMUNDA™

BOUNTY HUNTERS



BOUNTY HUNTER 1
059902701



BOUNTY HUNTER BODY 2
059906401

A COMPLETE
BOUNTY HUNTER 2
CONSISTS OF:
1 x BOUNTY HUNTER BODY 2
1 x BIONIC ARM



BIONIC ARM
059906402



BOUNTY HUNTER 2



BOUNTY HUNTER BODY 3
059902601

A COMPLETE
BOUNTY HUNTER 3
CONSISTS OF:
1 x BOUNTY HUNTER BODY 3
1 x BOUNTY HUNTER
BACKPACK



**BOUNTY HUNTER
BACKPACK**
059902602



BOUNTY HUNTER 3

MAD DONNA ULANTI



MAD DONNA ULANTI BODY
059903201

A COMPLETE
MAD DONNA ULANTI
CONSISTS OF:
1 x MAD DONNA ULANTI BODY
1 x MAD DONNA ULANTI ARM



MAD DONNA ULANTI ARM
059903202



MAD DONNA ULANTI



Bounty Hunters designed by Gary Morley, Mad Donna designed by Michael Perry

Not suitable for children under 36 months due to small parts and essential pointed components. All models supplied unpainted.

© Copyright Games Workshop Ltd., 1997. All rights reserved.

NECROMUNDA™

RATSKINS



RATSKIN WITH SHOTGUN 1
059902503



RATSKIN WITH LASGUN 1
059902501



RATSKIN WITH AUTOGUN AND PICK
059902502



RATSKIN WITH SHOTGUN 2
059902504



RATSKIN WITH AUTOGUN
059902505



RATSKIN WITH LASGUN 2
059902506



RATSKIN WITH AUTOGUN 2
059900803



RATSKIN WITH LASGUN 3
059900804



RATSKIN WITH MUSKET
059900805

UNDERHIVE SCUM



SCUM WITH AUTOPISTOL
AND PLASMA PISTOL
059906301



SCUM WITH PLASMA PISTOL
059906302



SCUM WITH HAND FLAMER
059906303



SCUM WITH BOLT PISTOLS
059906304



Designed by Michael Perry

NECROMUNDA™

RATSKIN CHIEFS



RATSKIN CHIEF 2
059904212



RATSKIN CHIEF 1
059900801

RATSKIN SHAMEN



RATSKIN SHAMAN 2
059904313



RATSKIN SHAMAN 1
059900802

BRAKAR – THE AVENGER, HE THAT RAINS DEATH



BRAKAR BODY
059904001

A COMPLETED BRAKAR CONSISTS OF:
1 x BRAKAR BODY
1 x BRAKAR'S HEAVY STUBBER



BRAKAR'S HEAVY STUBBER
059904002



BRAKAR – THE AVENGER

RATSKIN BRAVES



BRAVE WITH HANDBOW
059900806



BRAVE WITH MUSKET
059900807



BRAVE WITH STUB GUN
059900808



BRAVE WITH BLUNDERBUSS
059904111



BRAVE WITH AUTO PISTOL
059904110



BRAVE WITH MUSKET
059904109



Brakar designed by Gary Morley, Ratskins designed by Michael Perry

Not suitable for children under 36 months due to small parts and essential pointed components. All models supplied unpainted.
© Copyright Games Workshop Ltd., 1997. All rights reserved.

NECROMUNDA™

PIT SLAVES



PIT SLAVE BODY 1
059904401



PIT SLAVE BODY 2
059904402



PIT SLAVE BODY 3
059904403



PIT SLAVE BODY 4
059906811



PIT SLAVE BODY 5
059906812



PIT SLAVE TECHNO
059906901



ROCK DRILL
059904404



HAMMER
059904405

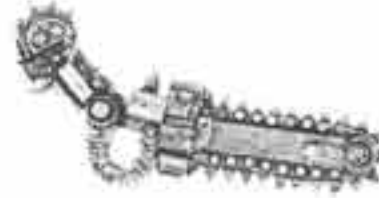

CHAINSAW
059904406



SHEARS
059904407



CLAW
059904408



BUZZ SAW
059904409



PIT SLAVE CHIEF
BUZZ SAW
059906702



PIT SLAVE CHIEF
SHOTGUN
059906703



PIT SLAVE CHIEF
MACE
059906704

**A COMPLETED PIT SLAVE
CONSISTS OF:**

- 1 x PIT SLAVE BODY
- 1 x PIT SLAVE ARM

**A COMPLETED PIT SLAVE
CHIEF CONSISTS OF:**

- 1 x PIT SLAVE CHIEF BODY
- 1 x PIT SLAVE CHIEF
BUZZ SAW
- 1 x PIT SLAVE CHIEF
MACE
- 1 x PIT SLAVE CHIEF
SHOTGUN



PIT SLAVE CHIEF
BODY
059906701



PIT SLAVE CHIEF



PIT SLAVE



Designed by Aly Morrison, Mike McVey and Mark Bedford

NECROMUNDA™

REDEMPTOR PRIEST



REDEMPTOR PRIEST
059900709

ARCH ZEALOT OF THE REDEMPTION

A COMPLETED ARCH ZEALOT
CONSISTS OF:
1 x ARCH ZEALOT BODY
1 x ARCH ZEALOT BACK BANNER



ARCH ZEALOT BODY
059903401



ARCH ZEALOT
BACK BANNER
059903402



ARCH ZEALOT

REDEMPTIONIST DEACON



DEACON BODY
059900707

A COMPLETED DEACON
CONSISTS OF:
1 x DEACON BODY
1 x DEACON FLAMER ARM



DEACON FLAMER ARM
059900708



DEACON WITH FLAMER

REDEMPTIONIST ZEALOT



ZEALOT WITH EVISCERATOR
059900706

REDEMPTIONIST BRETHERN



BRETHREN WITH
SHOTGUN 1
059900702



BRETHREN WITH
STUB GUN AND AUTOPISTOL
059900704



BRETHREN WITH
AUTOGUN 1
059900703



BRETHREN WITH
SHOTGUN 2
059900701



BRETHREN WITH
AUTOGUN 2
059900705



Designed by Gary Morley

Not suitable for children under 36 months due to small parts and essential pointed components. All models supplied unpainted.
© Copyright Games Workshop Ltd., 1997. All rights reserved.

NECROMUNDA™

REDEMPTOR PRIEST

A COMPLETED REDEMPTOR
PRIEST CONSISTS OF:
1 x REDEMPTOR PRIEST BODY
1 x REDEMPTOR PRIEST
SWORD ARM



REDEMPTOR PRIEST BODY
059903812



REDEMPTOR PRIEST
SWORD ARM
059903813



REDEMPTOR PRIEST

REDEMPTIONIST ZEALOT



ZEALOT WITH MASSIVE AXE
059903914

REDEMPTIONIST BRETHREN



BRETHREN WITH
TWO AUTO PISTOLS
059903711

REDEMPTIONIST DEACON



DEACON WITH
GRENADE LAUNCHER
059903610



CITADEL
MINIATURES



CITADEL
MINIATURES

NECROMUNDA™

SCAVVY BOSS



SCAVVY BOSS 1
059900901



SCAVVY BOSS 2
059904802

SCAVVY MUTANTS



SCAVVY WITH SPIKES
059905101



SCAVVY WITH CLAW
059905102



SCAVVY WITH EXTRA ARM
059905103

SCAVVIES



SCAVVY WITH STUB GUN AND KNIFE
059900905



SCAVVY WITH SHOTGUN 1
059900906



SCAVVY WITH STUB GUN AND PICK
059900907



SCAVVY WITH AUTOGUN
059900908



SCAVVY WITH SHOTGUN 2
059905002



SCAVVY WITH BLUNDERBUSS
059905004



SCAVVY WITH SHOTGUN 3
059905003



SCAVVY WITH AUTOPISTOL AND KNIFE
059905001

SCALY

A COMPLETE SCALY CONSISTS OF :
1 x SCALY BODY WITH HARPOON GUN
1 x HARPOON
1 x HARPOON PACK



SCALY BODY WITH HARPOON GUN
059900902



HARPOON PACK
059900904



HARPOON
059900903



SCALY WITH HARPOON GUN



SCALY WITH SCATTER CANNON
059904901



CITADEL
MINIATURES



CITADEL
MINIATURES

Designed by Colin Dixon

Not suitable for children under 36 months due to small parts and essential pointed components. All models supplied unpainted.
© Copyright Games Workshop Ltd., 1997. All rights reserved.

NECROMUNDA™

PLAGUE ZOMBIES



PLAGUE ZOMBIE 1
059900909



PLAGUE ZOMBIE 2
059900910

KARLOTH VALOIS



KARLOTH VALOIS
059904601



PLAGUE ZOMBIE 3
059904703



PLAGUE ZOMBIE 4
059904702



PLAGUE ZOMBIE 5
059904704



PLAGUE ZOMBIE 6
059904701

Karloth Valois designed by Gary Morley, Plague Zombies designed by Colin Dixon



CITADEL
MINIATURES

CITADEL
MINIATURES

NECROMUNDA™

SPYRE HUNTER – ORRUS



ORRUS 1
059902801



ORRUS BODY 2
059902802



ORRUS ARM
059902808



SPYRE HUNTER ORRUS 2

A COMPLETE SPYRE HUNTER
ORRUS 2 CONSISTS OF:
1 x ORRUS BODY 2
1 x ORRUS ARM

SPYRE HUNTER – JAKARA



JAKARA 1
059903109



JAKARA 2
059903110

SPYRE HUNTER – MALCADON



MALCADON 1
059902903



MALCADON 2
059902904

SPYRE HUNTER – YELD



YELD BODY 1
059903005



YELD BODY 2
059903007

A COMPLETED SPYRE HUNTER
YELD CONSISTS OF:
1 x YELD BODY
1 x YELD WINGS



YELD WINGS
059903006



SPYRE HUNTER YELD



Designed by Aly Morrison

NECROMUNDA™

WYRDS



WYRD BEASTMASTER 1
059903301



WYRD BEASTMASTER 2
059903302



WYRD BEASTMASTER 3
059903303



WYRD PYROMANIAC
059904501



WYRD TELEKINETIC
059905301



WYRD TELEPATH
059905201

MILLIASAURS



MILLIASAUR 1
059903311



MILLIASAUR 2
059903312



MILLIASAUR 3
059903310

RIPPER JACKS



RIPPER JACK 1
059903309



RIPPER JACK 2
059903308

NECROMUNDAN GIANT RATS



GIANT RAT 1
059903304



GIANT RAT 2
059903305



GIANT RAT 3
059903306



RIPPER JACK 3
059903307



CITADEL
MINIATURES



CITADEL
MINIATURES

Beastmasters designed by Aly Morrison, Pyromaniac, Telekinetic and Telepath by Brian Nelson, Creatures by Trish Morrison

WARHAMMER

EPIIC 40,000



EPIC® 40,000

SPACE MARINE COMMAND LAND RAIDER

LAND RAIDER TRACK
030100801

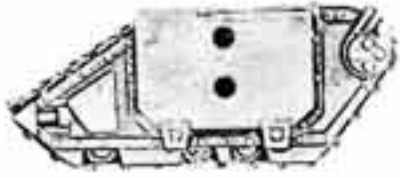

LEFT SIDE



RIGHT SIDE

LAND RAIDER SPONSON
030100804



LEFT SIDE



RIGHT SIDE



LAND RAIDER HATCH
030100805



LAND RAIDER TOP PLATE
030100803



LAND RAIDER HULL
030100802



A COMPLETED SPACE MARINE
COMMAND LAND RAIDER CONSISTS OF:
1 x LAND RAIDER HULL
1 x SET OF LAND RAIDER TRACKS
1 x LAND RAIDER TOP PLATE
1 x LAND RAIDER HATCH
1 x SET OF LAND RAIDER SPONSONS



SPACE MARINE COMMAND LAND RAIDER
WITH MODELLED AERIALS

SPACE MARINE LAND SPEEDER



LAND SPEEDER 1
030100602



LAND SPEEDER 2
030100604



LAND SPEEDER 3
030100605

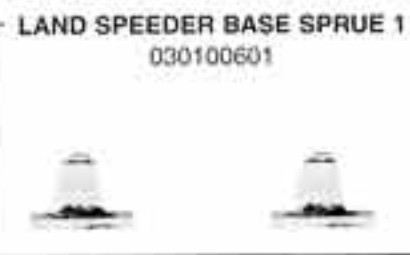

LAND SPEEDER BASE SPRUE 1
030100601

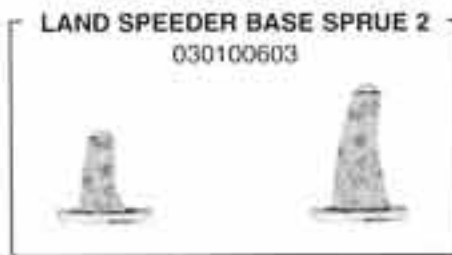

LAND SPEEDER BASE SPRUE 2
030100603



SPACE MARINE LAND SPEEDERS

A COMPLETED SPACE MARINE
LAND SPEEDER CONSISTS OF:
1 x LAND SPEEDER
1 x LAND SPEEDER BASE

SPACE MARINE ATTACK BIKE



ATTACK BIKE 1
030100702



ATTACK BIKE 2
030100705

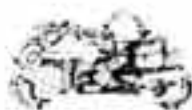

ATTACK BIKE 3
030100706



ATTACK BIKE SIDECAR 1
030100701



ATTACK BIKE SIDECAR 2
030100703



ATTACK BIKE SIDECAR 3
030100704



SPACE MARINE ATTACK BIKES

A COMPLETED SPACE MARINE
ATTACK BIKE CONSISTS OF:
1 x ATTACK BIKE
1 x SIDECAR



EPIC[®] 40,000

SPACE MARINE PREDATOR

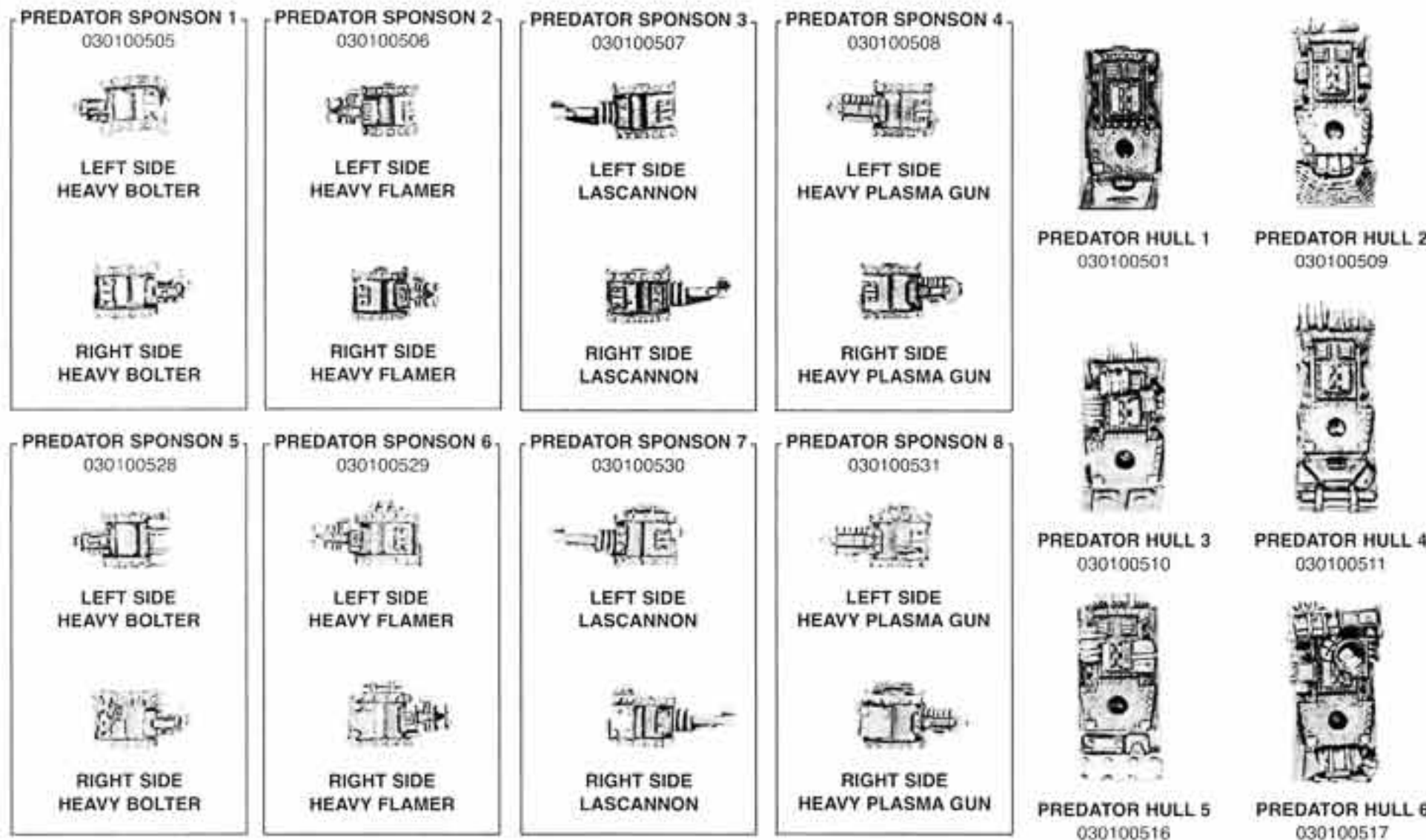
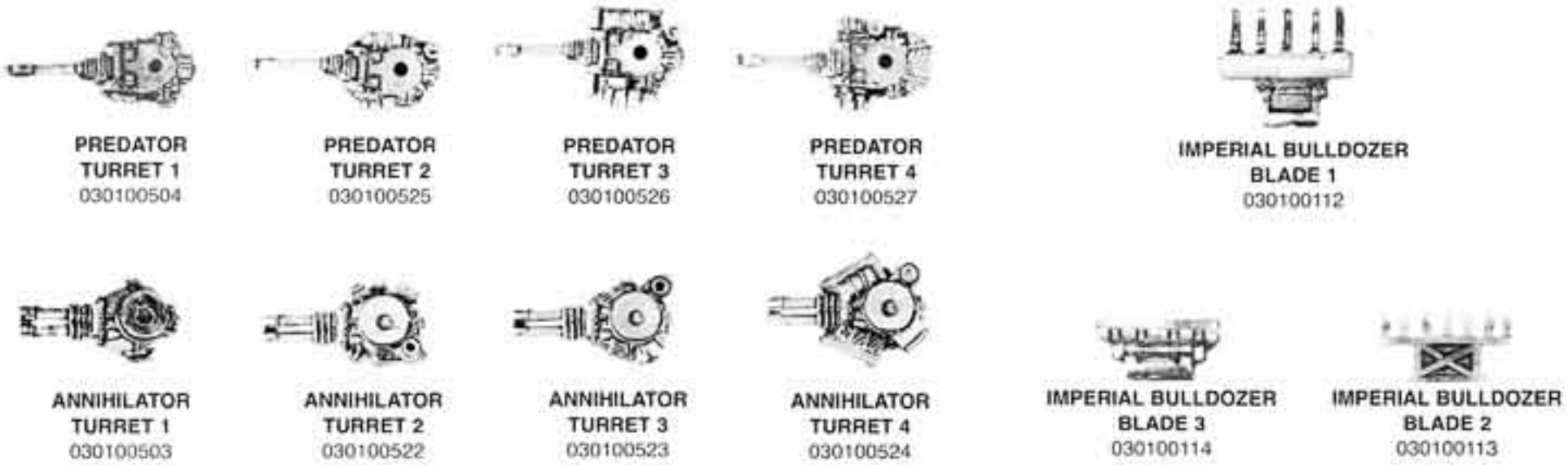
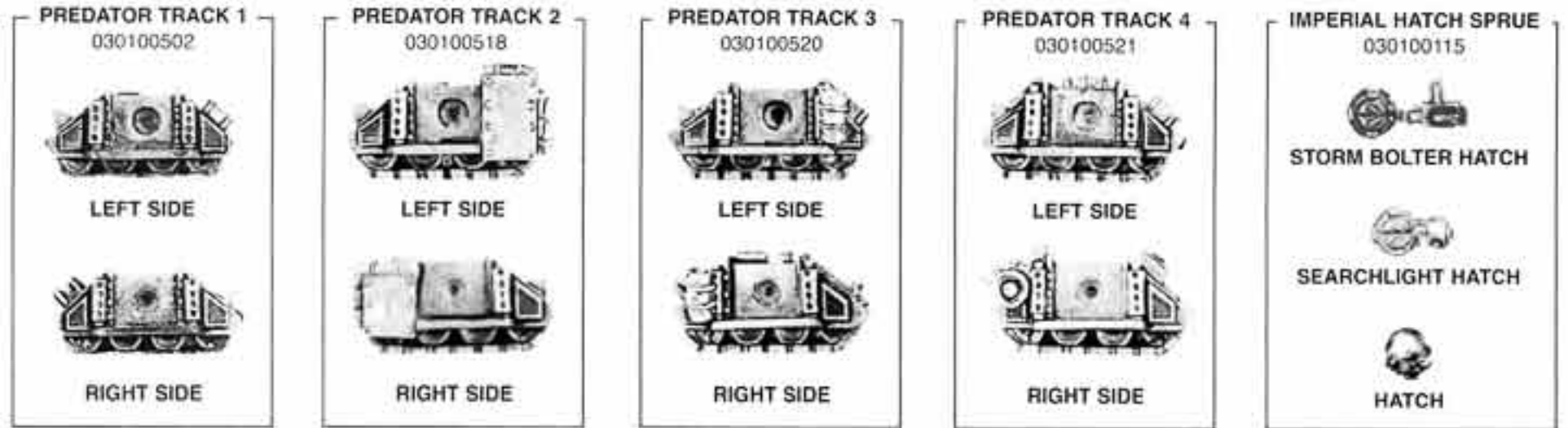

A COMPLETED SPACE MARINE PREDATOR CONSISTS OF:

- 1 x PREDATOR HULL
- 1 x SET OF PREDATOR TRACKS
- 1 x IMPERIAL HATCH
- 1 x PREDATOR OR ANNIHILATOR TURRET
- 1 x SET OF PREDATOR SPONSONS
- 1 x IMPERIAL BULLDOZER BLADE



Designed by Tim Adcock

EPIC® 40,000

SPACE MARINE RAZORBACK

RAZORBACK TRACK 1
030100301



LEFT SIDE



RIGHT SIDE

RAZORBACK TRACK 2
030100304



LEFT SIDE



RIGHT SIDE

RAZORBACK TRACK 3
030100305

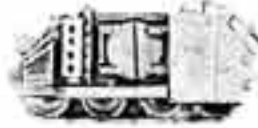

LEFT SIDE



RIGHT SIDE

RAZORBACK TRACK 4
030100306



LEFT SIDE



RIGHT SIDE

RAZORBACK TRACK 5
030100307



LEFT SIDE



RIGHT SIDE



RAZORBACK HULL 1
030100302



RAZORBACK HULL 2
030100308



RAZORBACK HULL 3
030100309



RAZORBACK HULL 4
030100310

IMPERIAL HATCH SPRUE
030100115



STORM BOLTER HATCH

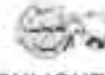

SEARCHLIGHT HATCH



HATCH

A COMPLETED SPACE MARINE RAZORBACK CONSISTS OF:
1 x RAZORBACK HULL
1 x SET OF RAZORBACK TRACKS
1 x RAZORBACK TURRET
1 x IMPERIAL BULLDOZER BLADE

A COMPLETED SPACE MARINE RAZORBACK 4 CONSISTS OF:
1 x RAZORBACK HULL
1 x SET OF RAZORBACK TRACKS
1 x RAZORBACK TURRET
1 x IMPERIAL BULLDOZER BLADE
1 x IMPERIAL HATCH



RAZORBACK TURRET 1
030100303



RAZORBACK TURRET 2
030100311



RAZORBACK TURRET 3
030100312



RAZORBACK TURRET 4
030100313

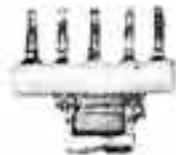

IMPERIAL BULLDOZER BLADE 1
030100112



IMPERIAL BULLDOZER BLADE 2
030100113



IMPERIAL BULLDOZER BLADE 3
030100114



RAZORBACK

SPACE MARINE DREADNOUGHT



DREADNOUGHT 1
030100401

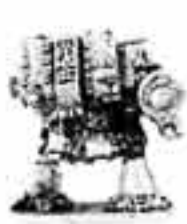

DREADNOUGHT 2
030100405



DREADNOUGHT 3
030100406



DREADNOUGHT 4
030100407



DREADNOUGHT LEFT ARM POWERFIST
030100408



DREADNOUGHT LEFT ARM MISSILE LAUNCHER
030100409

THE LEFT ARMS CAN ONLY BE USED WITH DREADNOUGHT 4

A COMPLETED SPACE MARINE DREADNOUGHT CONSISTS OF:
1 x DREADNOUGHT
1 x DREADNOUGHT ARM SPRUE

A COMPLETED SPACE MARINE DREADNOUGHT 4 CONSISTS OF:
1 x DREADNOUGHT 4
1 x DREADNOUGHT ARM SPRUE
1 x DREADNOUGHT LEFT ARM

DREADNOUGHT ARM SPRUE 1
030100402



TWIN LASCANNON



POWERFIST

DREADNOUGHT ARM SPRUE 2
030100403



ASSAULT CANNON



POWERFIST

DREADNOUGHT ARM SPRUE 3
030100404



MULTI-MELTA



LIGHTNING CLAW



SPACE MARINE DREADNOUGHTS



CITADEL MINIATURES

EPIC® 40,000

SPACE MARINE BATTLE GROUP SPRUE

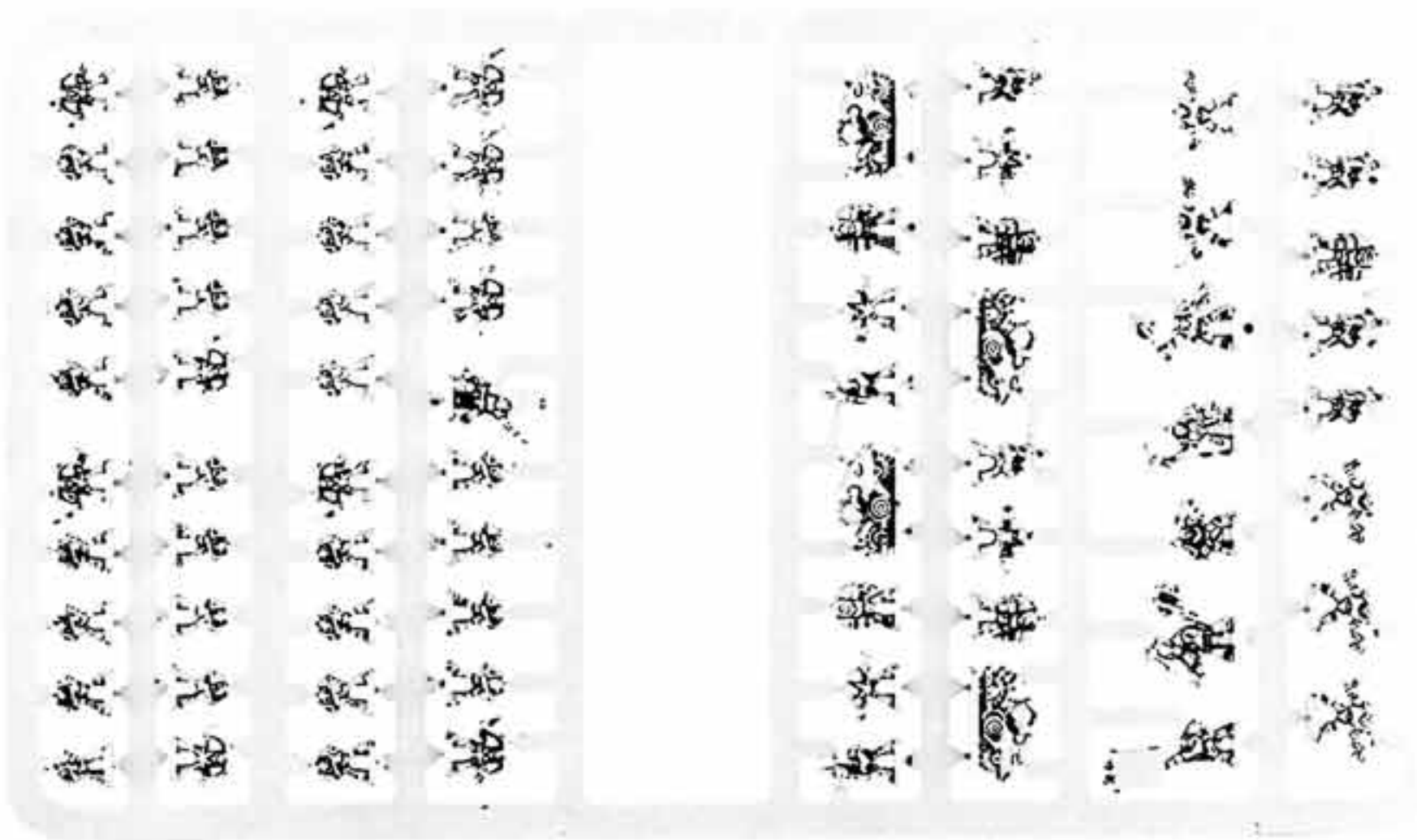

SPACE MARINE BATTLE GROUP (SHOWN AT 85% OF ACTUAL SIZE)
99389999037

SPACE MARINE BATTLE GROUP SPRUE CONTENTS:

29 x SPACE MARINES WITH BOLT GUNS, 8 x DEVASTATOR MARINES, 10 x ASSAULT MARINES, 5 x TERMINATORS, 5 x SCOUTS, 4 x BIKES
1 x SPACE MARINE CAPTAIN, 1 x COMPANY STANDARD, 1 x CHAPLAIN, 1 x LIBRARIAN, 1 x APOTHECARY, 1 x TECHMARINE

SPACE MARINE TANK SPRUE

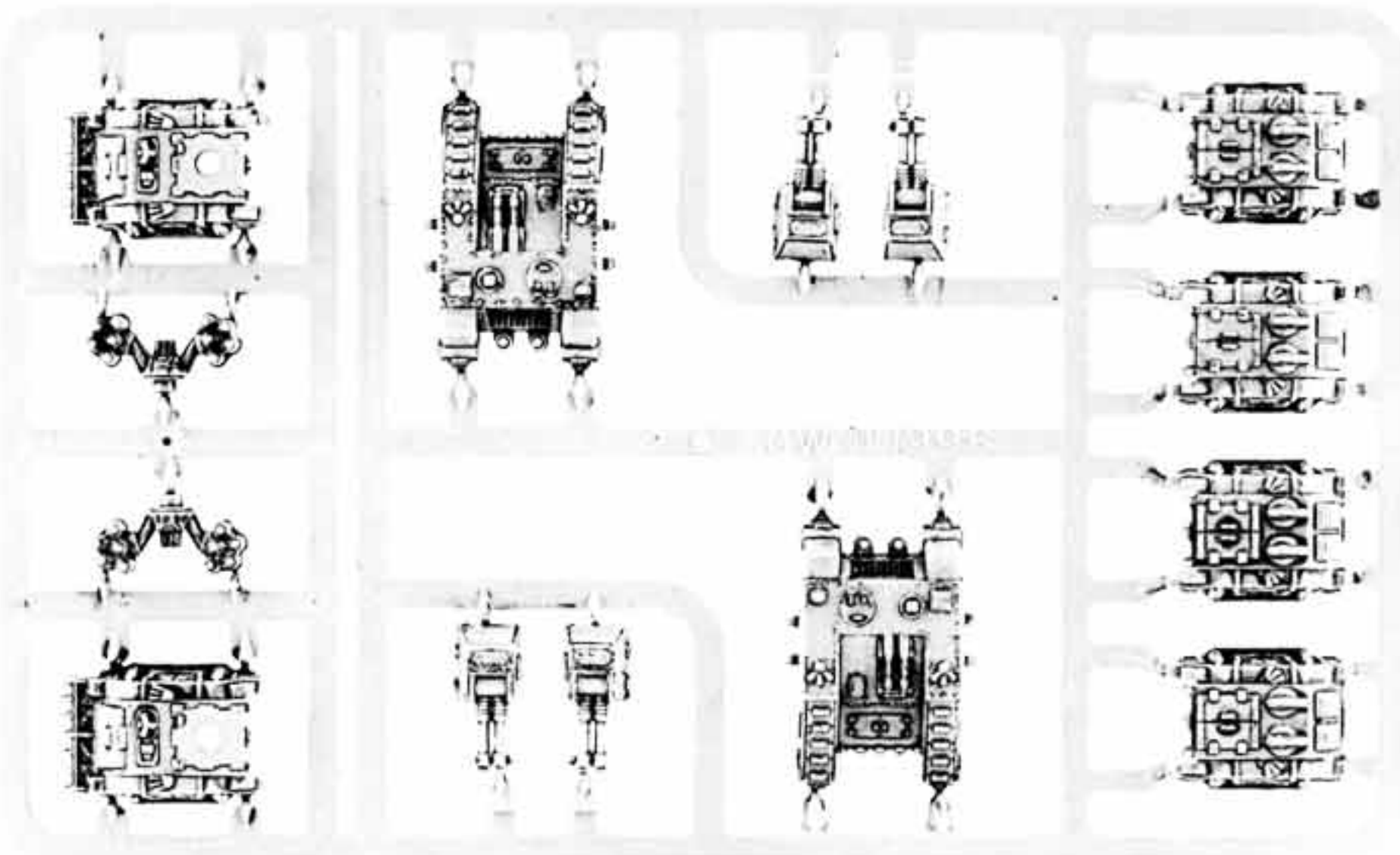

SPACE MARINE TANK SPRUE (SHOWN AT 90% OF ACTUAL SIZE)
99389999036

SPACE MARINE TANK SPRUE CONTENTS:

2 x WHIRLWIND, 4 x RHINO, 2 x LAND RAIDER



EPIC® 40,000

SPACE MARINE THUNDERHAWK GUNSHIP

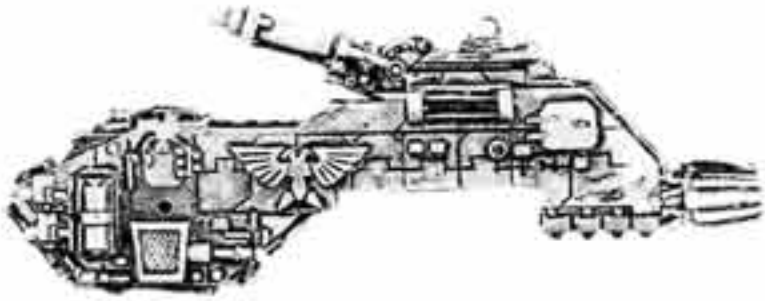

HULL
030100201



WING SUPPORTS
030100204



SPACE MARINE THUNDERHAWK GUNSHIP

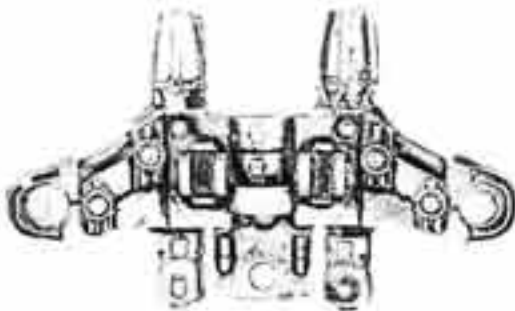

ENGINES
030100202

TWIN LINKED HEAVY BOLTERS
030100207



TAIL FIN
030100208

A COMPLETED SPACE MARINE THUNDERHAWK GUNSHIP CONSISTS OF:
1 x HULL
1 x ENGINES
1 x SET OF CANARDS
2 x TWIN LINKED HEAVY BOLTERS
2 x WING SUPPORTS
1 x SET OF LANDING LEGS
1 x TAIL FIN

CANARDS
030100203

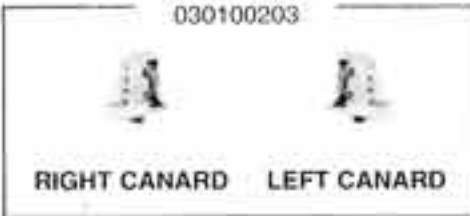

RIGHT CANARD LEFT CANARD

LANDING LEGS
030100209



AFT LANDING LEGS FRONT LANDING LEG



Designed by Tim Adcock



EPIC® 40,000

SPACE MARINE VINDICATOR ASSAULT TANK

TRACKS 1
030100105



LEFT SIDE



RIGHT SIDE

TRACKS 2
030100106



LEFT SIDE



RIGHT SIDE



HULL 1
030100101



BULLDOZER BLADE 1
030100112



BULLDOZER BLADE 2
030100113

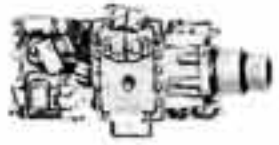

HULL 2
030100102



BULLDOZER BLADE 3
030100114

TRACKS 3
030100107



LEFT SIDE



RIGHT SIDE

TRACKS 4
030100108



LEFT SIDE



RIGHT SIDE



HULL 3
030100103

A COMPLETED SPACE
MARINE VINDICATOR
CONSISTS OF:
1 x HULL
1 x SET OF TRACKS
1 x HATCH
1 x BULLDOZER BLADE



HULL 4
030100104

Parts from the Space Marine Vindicator assault tank are interchangeable. For example, you could choose tracks 3 to go with hull 1, hatch 2, etc, creating your own Vindicator combinations as we have done with these examples below.

IMPERIAL HATCHES
030100115



SPACE MARINE VINDICATOR ASSAULT TANKS

Designed by Tim Adcock



EPIC® 40,000

IMPERIAL WARLORD TITAN



TOP CARAPACE
030700101



HEAD ARMOUR PLATING
030700108



IMPERIAL WARLORD TITAN



BACK CARAPACE
030700102



LEG JOINT
030700109

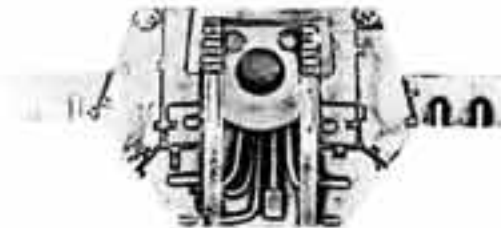

FRONT CARAPACE
030700103



JOINT PLATE
030700110



BODY ARMOUR PLATING
030700111



HEAD
030700104

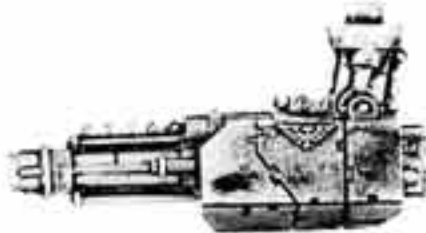

DEATH RAY/MEGA-CANNON
030700106

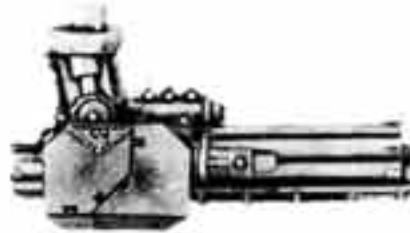

HEAVY WEAPON BATTERY
030700105



RIGHT LEG ARMOUR PLATING
030700115



LEFT LEG ARMOUR PLATING
030700114

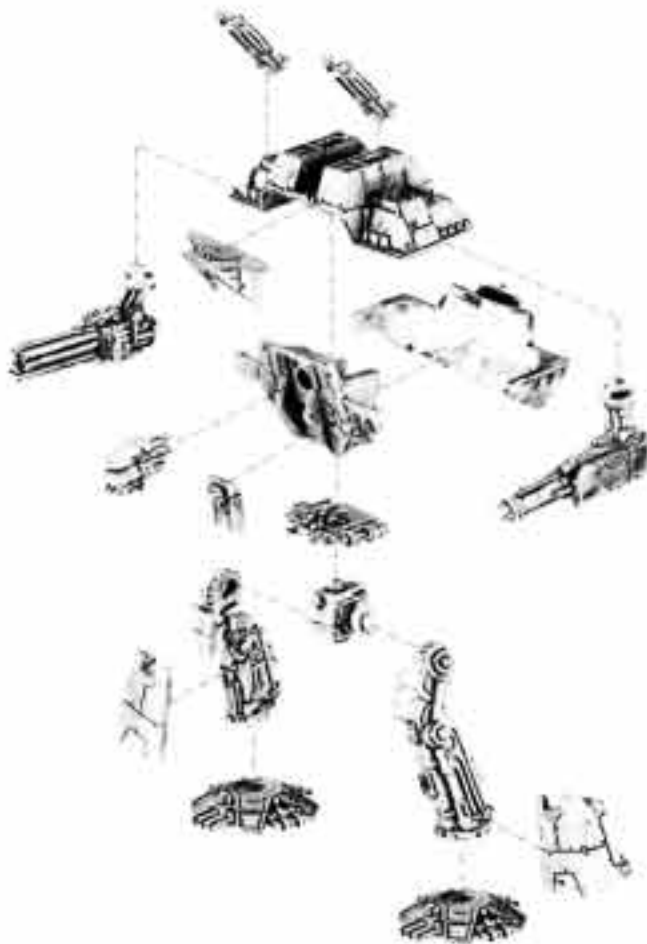

A COMPLETED IMPERIAL WARLORD TITAN CONSISTS OF:

- 1 x TOP CARAPACE
- 1 x FRONT CARAPACE
- 1 x BACK CARAPACE
- 1 x HEAD
- 1 x HEAD ARMOUR PLATING
- 1 x JOINT PLATE
- 1 x LEG JOINT
- 1 x BODY ARMOUR PLATING
- 1 x HEAVY WEAPON BATTERY
- 1 x DEATH RAY/MEGA-CANNON
- 2 x CARAPACE HEAVY WEAPON BATTERY
- 1 x LEFT LEG
- 1 x RIGHT LEG
- 1 x LEFT LEG ARMOUR PLATING
- 1 x RIGHT LEG ARMOUR PLATING
- 2 x FEET
- 1 x TITAN BASE



RIGHT LEG
030700112



LEFT LEG
030700113



FOOT
030700116



CARPACE HEAVY WEAPON BATTERY
030700107



Designed by Dave Andrews

EPIC® 40,000

TYRANID DOMINATRIX



BODY LEFT SIDE
030600101



BODY RIGHT SIDE
030600102



THRONE BACK
030600105



TYRANID DOMINATRIX



THRONE
030600104



HEAD
030600103

A COMPLETED TYRANID
DOMINATRIX CONSISTS
OF :

- 1 x RIGHT BODY
- 1 x LEFT BODY
- 1 x HEAD
- 1 x THRONE
- 1 x THRONE BACK



TYRANID HIVE TYRANT



HIVE TYRANT 1
030600201



HIVE TYRANT 2
030600202



HIVE TYRANT 3
030600203

TYRANID SWARM SPRUE

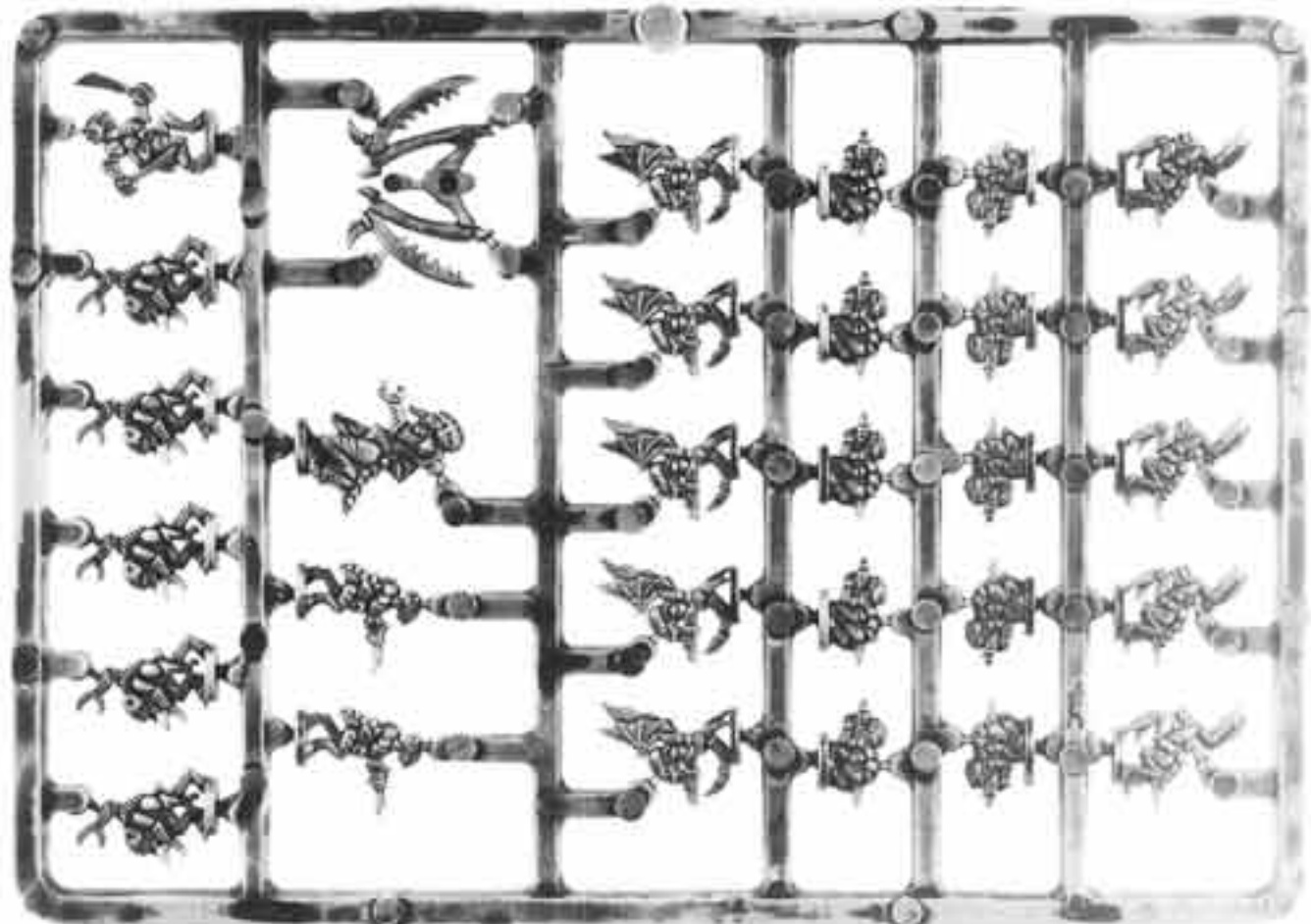

TYRANID SWARM SPRUE (SHOWN AT 85% OF ACTUAL SIZE)
99380306001

TYRANID SWARM SPRUE CONTENTS:

- 3 x TYRANID WARRIORS, 1 x LICTOR, 5 x GENESTEALERS, 10 x TERMAGANTS
- 5 x HORMAGANTS, 5 x GARGOYLES



Designed by Alan Perry, Aly Morrison and Dave Andrews

Not suitable for children under 8 years due to small parts and essential pointed components. All models supplied unpainted.
© Copyright Games Workshop Ltd. 1998. All rights reserved.

EPIC® 40,000

TYRANID ASSAULT SPAWN, HARUSPEX



HARUSPEX BODY 1
030601301



HARUSPEX JAW 1
030601304



HARUSPEX LEFT ARM 1
030601302



HARUSPEX RIGHT ARM 1
030601303



HARUSPEX BODY 2
030601305



HARUSPEX JAW 2
030601307



HARUSPEX LEFT ARM 2
030601309



HARUSPEX RIGHT ARM 2
030601311



HARUSPEX BODY 3
030601306



HARUSPEX JAW 3
030601308



HARUSPEX LEFT ARM 3
030601310



HARUSPEX RIGHT ARM 3
030601312



HARUSPEXES

A COMPLETED TYRANID HARUSPEX CONSISTS OF:
1 x HARUSPEX BODY
1 x HARUSPEX JAW
1 x HARUSPEX RIGHT ARM
1 x HARUSPEX LEFT ARM



TYRANID ASSAULT SPAWN, MALEFACTOR



MALEFACTOR BODY 1
030601201



MALEFACTOR BODY 2
030601204



MALEFACTOR BODY 3
030601207



MALEFACTOR LEFT ARM 1
030601202



MALEFACTOR LEFT ARM 2
030601205



MALEFACTOR LEFT ARM 3
030601208

A COMPLETED TYRANID MALEFACTOR CONSISTS OF:
1 x MALEFACTOR BODY
1 x MALEFACTOR RIGHT ARM
1 x MALEFACTOR LEFT ARM



MALEFACTOR RIGHT ARM 1
030601203



MALEFACTOR RIGHT ARM 2
030601206



MALEFACTOR RIGHT ARM 3
030601209



MALEFACTORS



EPIC® 40,000

TYRANID HARRIDAN



HARRIDAN BODY
030600501



HARRIDAN LEFT WING
030600502



HARRIDAN RIGHT WING
030600503

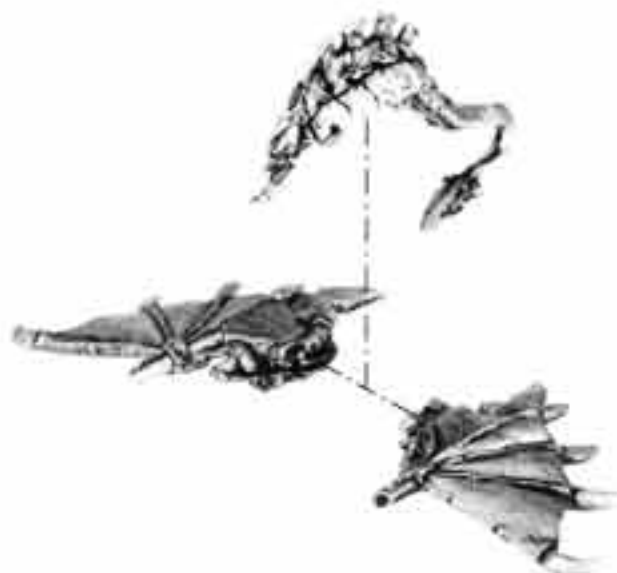

A COMPLETED TYRANID
HARRIDAN CONSISTS OF:
1 x HARRIDAN BODY
1 x HARRIDAN LEFT WING
1 x HARRIDAN RIGHT WING



HARRIDAN

TYRANID DACTYLIS



DACTYLIS BODY 1
030601001



DACTYLIS BODY 2
030601004



DACTYLIS BODY 3
030601005



DACTYLIS RIGHT ARM 1
030601002



DACTYLIS LEFT ARM 1
030601003

A COMPLETED TYRANID
DACTYLIS CONSISTS OF:
1 x DACTYLIS BODY
1 x DACTYLIS RIGHT ARM
1 x DACTYLIS LEFT ARM



DACTYLIS RIGHT ARM 2
030601006



DACTYLIS LEFT ARM 2
030601007



DACTYLIS



DACTYLIS RIGHT ARM 3
030601009



DACTYLIS LEFT ARM 3
030601008



Designed Dave Andrews and Alan Perry

Not suitable for children under 8 years due to small parts and essential pointed components. All models supplied unpainted.
© Copyright Games Workshop Ltd. 1998. All rights reserved.

EPIC® 40,000

TYRANID ASSAULT SPAWN, TRYGON



TRYGON BODY
030601102



TRYGON CLAWS
030601103



TRYGON HEAD
030601101

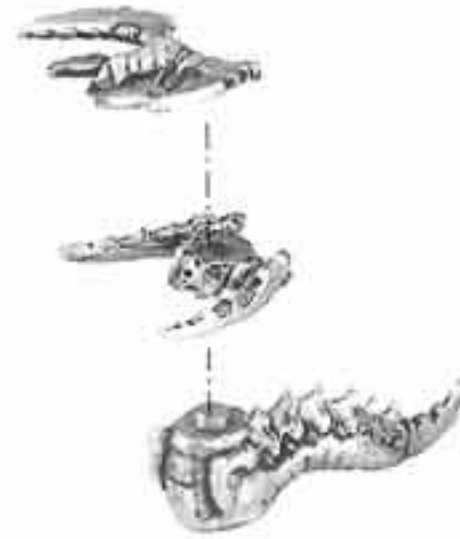

TRYGONS

A COMPLETED TYRANID
ASSAULT SPAWN, TRYGON CONSISTS OF:
1 x TRYGON BODY
1 x TRYGON CLAWS
1 x TRYGON HEAD

TYRANID BIOVORES



BIOVORE 1
030600602



BIOVORE 2
030600603



BIOVORE 3
030600604



BIOVORES

TYRANID EXOCRINES



EXOCRINE 1
030600901



EXOCRINE 2
030600902



EXOCRINE 3
030600903



EXOCRINES



EPIC® 40,000

TYRANID CARNIFEX



CARNIFEX HEAD 1
030600801



CARNIFEX HEAD 2
030600802



CARNIFEX HEAD 3
030600805



CARNIFEX HEAD 4
030600806



CARNIFEX LEGS 1
030600803



CARNIFEX LEGS 2
030600804

A COMPLETED TYRANID
CARNIFEX CONSISTS OF:
1 x CARNIFEX HEAD
1 x CARNIFEX LEGS



CARNIFEXES



TYRANID ZOANTHROPE



ZOANTHROPE HEAD 1
030600702



ZOANTHROPE BODY 1
030600701



ZOANTHROPES



ZOANTHROPE HEAD 2
030600704



ZOANTHROPE BODY 2
030600703



ZOANTHROPE HEAD 3
030600705



ZOANTHROPE BODY 3
030600707



ZOANTHROPE HEAD 4
030600706

A COMPLETED TYRANID
ZOANTHROPE CONSISTS OF:
1 x ZOANTHROPE HEAD
1 x ZOANTHROPE BODY



Designed by Paul Muller

EPIC® 40,000

TYRANID BIO-TITAN, HIEROPHANT

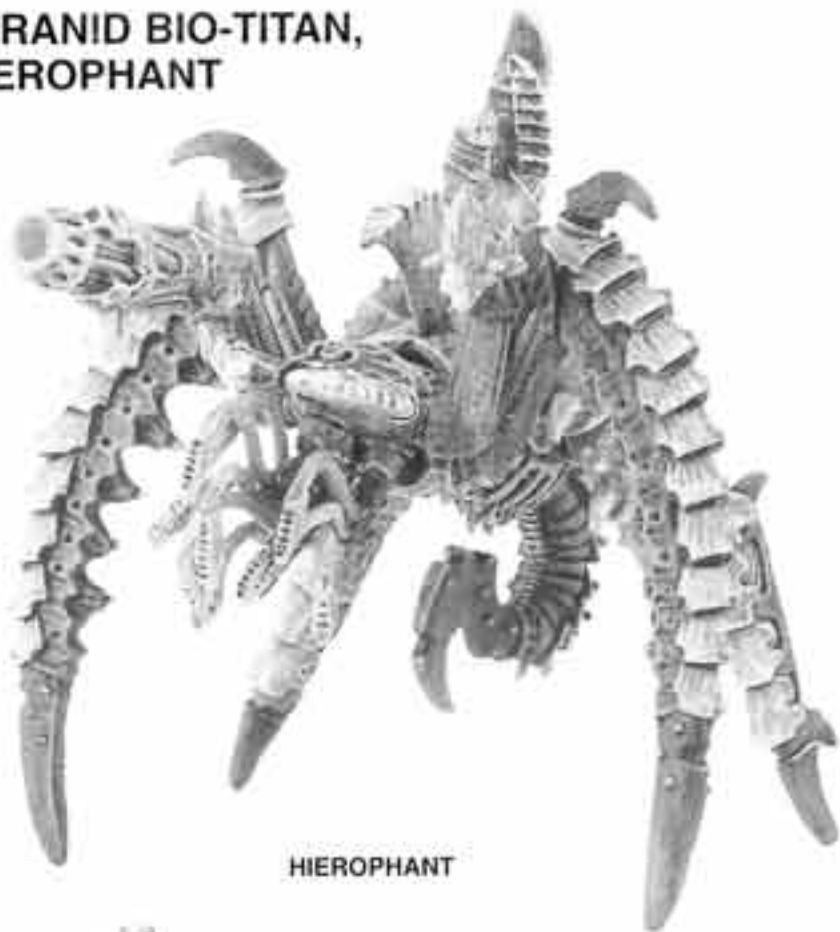

HIEROPHANT



HIEROPHANT FRONT LEGS
030600303



HIEROPHANT HEAD 1
030600310



HIEROPHANT HEAD 2
030600301



HIEROPHANT RIPPER TENTACLES
030600302



HIEROPHANT BODY
030600304



HIEROPHANT LEFT LEG
030600305



HIEROPHANT RIGHT LEG
030600306



HIEROPHANT LEFT BIO-CANNON 1
030600307



HIEROPHANT LEFT BIO-CANNON 2
030600308

**A COMPLETED TYRANID BIO-TITAN
HIEROPHANT CONSISTS OF:**
 1 x HIEROPHANT BODY
 1 x HIEROPHANT HEAD
 1 x HIEROPHANT FRONT LEGS
 1 x HIEROPHANT RIGHT LEG
 1 x HIEROPHANT LEFT LEG
 1 x HIEROPHANT RIGHT WEAPON
 1 x HIEROPHANT LEFT WEAPON
 3 x HIEROPHANT RIPPER TENTACLES



HIEROPHANT RIGHT BIO-CANNON
030600312



HIEROPHANT RIGHT RAZOR CLAW
030600309



HIEROPHANT LEFT RAZOR CLAW
030600311



CITADEL
MINIATURES



CITADEL
MINIATURES

EPIC® 40,000

TYRANID BIO-TITAN, HIERODULE



HIERODULE



HIERODULE FRONT LEGS
030600402



HIERODULE HEAD 1
030600401



HIERODULE HEAD 2
030600413



HIERODULE RIGHT LEG
030600404



HIERODULE LEFT LEG
030600405



HIERODULE BODY
030600403



HIERODULE LEFT BIO-CANNON 1
030600407



HIERODULE RIGHT BIO-CANNON
030600412



HIERODULE LEFT BIO-CANNON 2
030600408



HIERODULE RIGHT CLUSTER SPINE
030600406



HIERODULE LEFT RAZOR CLAW
030600411

A COMPLETED TYRANID BIO-TITAN HIERODULE CONSISTS OF:

- 1 x HIERODULE BODY
- 1 x HIERODULE HEAD
- 1 x HIERODULE FRONT LEGS
- 1 x HIERODULE RIGHT LEG
- 1 x HIERODULE LEFT LEG
- 1 x HIERODULE RIGHT WEAPON
- 1 x HIERODULE LEFT WEAPON

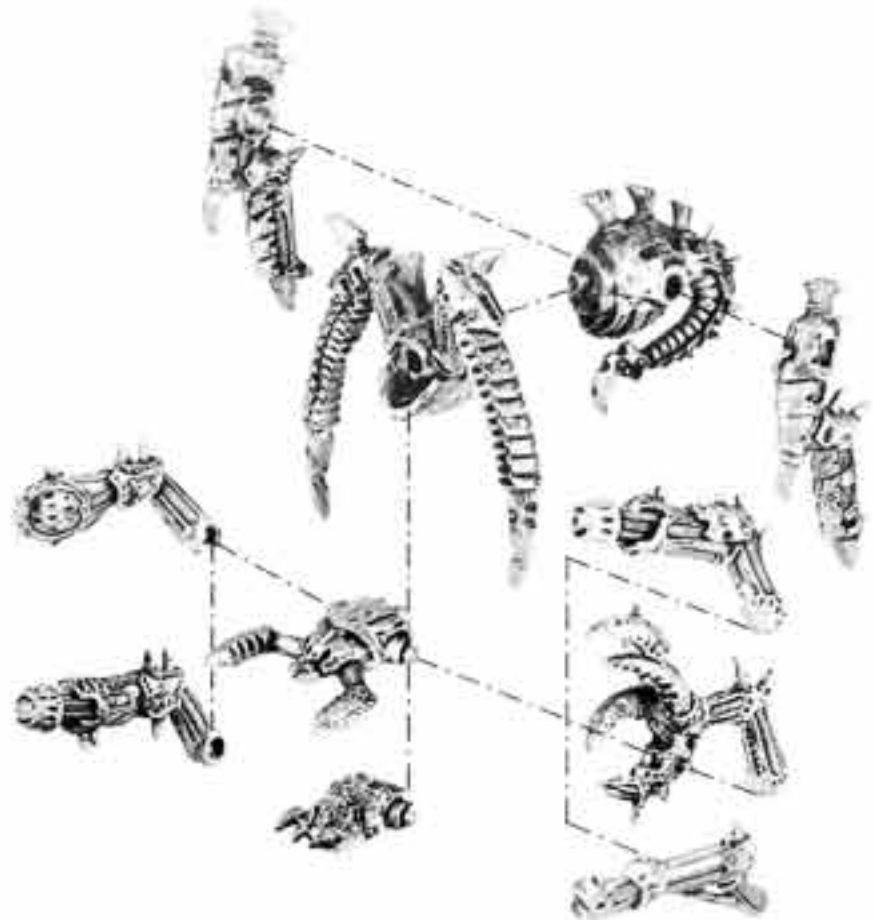

CITADEL
MINIATURES



CITADEL
MINIATURES

Designed by Dave Andrews

EPIC® 40,000

ELDAR FALCON GRAV-TANK

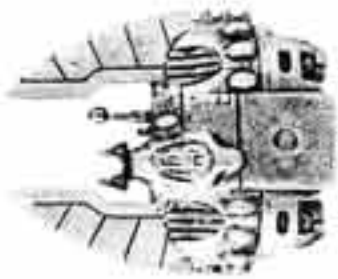

HULL 1
030400102

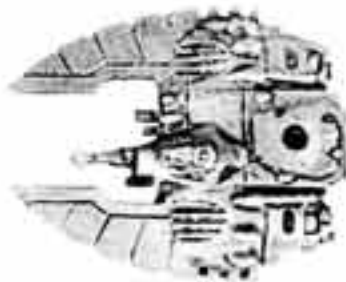

HULL 2
030400103



HULL 3
030400104

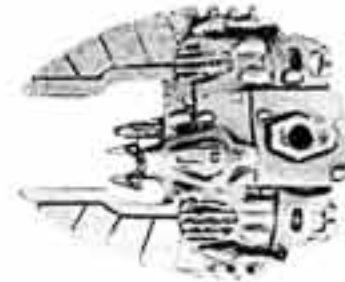

HULL 4
030400105



TURRET 1
030400101



TURRET 2
030400106



TURRET 3
030400107



TURRET 4
030400108

Parts from the Eldar Falcon Grav-Tank are interchangeable. For example, you could choose hull 3 to go with turret 1, etc, creating your own Falcon Grav-Tank combinations as we have done with this example.



ELDAR FALCON GRAV-TANK

THE COMPLETE FALCON GRAV-TANK CONSISTS OF:
1 x HULL
1 x TURRET

ELDAR WAVE SERPENT



HULL 1
030400201



HULL 2
030400203



TURRET 1
030400202



TURRET 2
030400204

THE COMPLETE WAVE SERPENT CONSISTS OF:
1 x HULL
1 x TURRET



ELDAR WAVE SERPENT

Parts from the Eldar Wave Serpent are interchangeable. For example, you could choose hull 2 to go with turret 1, etc, creating your own Eldar Wave Serpent combinations as we have done with this example.

Designed by Tim Adcock



EPIC® 40,000

ELDAR SUPREME COMMANDERS

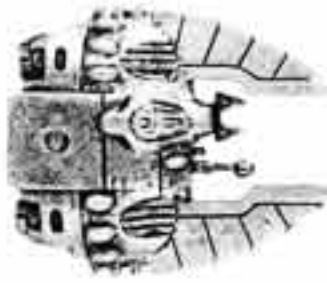

FALCON HULL 1
030400102

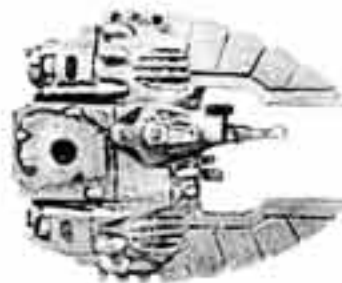

FALCON HULL 2
030400103

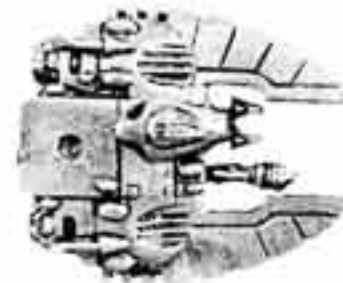

FALCON HULL 3
030400104



FALCON HULL 4
030400105

FARSEER FALCON
TURRET WING SPRUE
030400507



FARSEER
FALCON LEFT
TURRET WING



FARSEER
FALCON RIGHT
TURRET WING



FARSEER FALCON TURRET
030400506

A COMPLETE ELDAR FARSEER
FALCON CONSISTS OF:
1 x FALCON HULL
1 x FARSEER FALCON TURRET
1 x FARSEER FALCON
TURRET WING SPRUE



ELDAR FARSEER FALCON



VYPER JET BIKE HULL
030400809



FARSEER VYPER PLATFORM
030400510

FARSEER VYPER BASE SPRUE 1
030100601



ELDAR AVATAR
030400508

A COMPLETE ELDAR
FARSEER VYPER
CONSISTS OF:
1 x VYPER JETBIKE
HULL
1 x FARSEER VYPER
PLATFORM
1 x FARSEER VYPER
BASE SPRUE



ELDAR FARSEER VYPER

FARSEER VYPER BASE SPRUE 2
030100603



ELDAR AVATAR

ELDAR WAR WALKER



WAR WALKER LEGS 1
030400606



WAR WALKER LEGS 2
030400607



WAR WALKER LEGS 3
030400608



WAR WALKER LEGS 4
030400609



WAR WALKER TURRET 1
030400601



WAR WALKER TURRET 2
030400602



WAR WALKER WING
030400605



WAR WALKER TURRET 3
030400603



WAR WALKER TURRET 4
030400604

A COMPLETE ELDAR WAR
WALKER CONSISTS OF:
1 x WAR WALKER LEGS
1 x WAR WALKER TURRET
1 x WAR WALKER WING



ELDAR WAR WALKERS



CITADEL
MINIATURES



CITADEL
MINIATURES

Designed by Tim Adcock

Not suitable for children under 36 months due to small parts and essential pointed components. All models supplied unpainted.
© Copyright Games Workshop Ltd., 1997. All rights reserved.

EPIC 40,000

ELDAR VYPER JETBIKE



VYPER JETBIKE
HULL
030400809



VYPER JETBIKE
TURRET 1
MISSILE LAUNCHER
030400801



VYPER JETBIKE
TURRET 2
SCATTER LASER
030400802



VYPER JETBIKE
TURRET 3
D-CANNON
030400803



VYPER JETBIKE
TURRET 4
HEAVY PLASMA GUN
030400804



VYPER JETBIKE
TURRET 5
SHURIKEN CANNON
030400805

VYPER JETBIKE BASE SPRUE 1
030100601



VYPER JETBIKE BASE SPRUE 2
030100603



A COMPLETE ELDAR VYPER
JETBIKE CONSISTS OF:
1 x VYPER JETBIKE HULL
1 x VYPER JETBIKE TURRET
1 x VYPER JETBIKE BASE
SPRUE



ELDAR VYPER JETBIKE

ELDAR HEAVY WEAPON SUPPORT PLATFORM



SUPPORT PLATFORM
HULL
030400901



SUPPORT PLATFORM
HEAVY WEAPON 1
SCATTER LASER
030400902

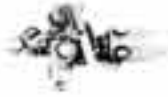

SUPPORT PLATFORM
HEAVY WEAPON 2
HEAVY PLASMA GUN
030400903



SUPPORT PLATFORM
HEAVY WEAPON 3
LAS CANNON
030400904



SUPPORT PLATFORM
HEAVY WEAPON 4
D-CANNON
030400905



SUPPORT PLATFORM
HEAVY WEAPON 5
MISSILE LAUNCHER
030400906

A COMPLETE ELDAR HEAVY WEAPON
SUPPORT PLATFORM CONSISTS OF:
1 x SUPPORT PLATFORM HULL
1 x SUPPORT PLATFORM HEAVY WEAPON



ELDAR HEAVY WEAPON SUPPORT PLATFORM

ELDAR DREADNOUGHT



DREADNOUGHT
BODY
030400701



DREADNOUGHT HEAD
AND WEAPON
030400702

A COMPLETE ELDAR DREADNOUGHT
CONSISTS OF:
1 x DREADNOUGHT BODY
1 x DREADNOUGHT HEAD AND WEAPON



DREADNOUGHTS



Designed by Tim Adcock

EPIC 40,000

ELDAR NIGHT SPINNER



NIGHT SPINNER HULL 1
030401201

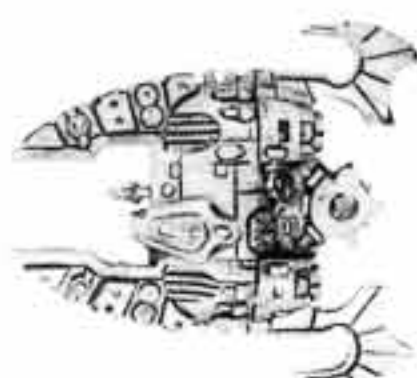

NIGHT SPINNER HULL 2
030401206

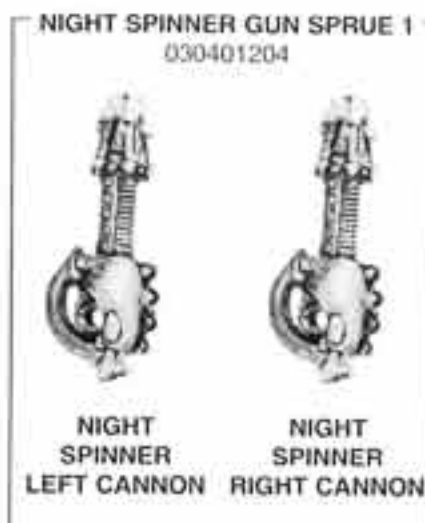

NIGHT SPINNER GUN SPRUE 1
030401204

NIGHT SPINNER LEFT CANNON NIGHT SPINNER RIGHT CANNON



NIGHT SPINNER GUN SPRUE 2
030401205

NIGHT SPINNER LEFT CANNON NIGHT SPINNER RIGHT CANNON



NIGHT SPINNER CANNON MOUNT
030401202



NIGHT SPINNER TURRET 1
030401203



NIGHT SPINNER TURRET 2
030401207

A COMPLETE NIGHT SPINNER CONSISTS OF:
1 x NIGHT SPINNER HULL
1 x NIGHT SPINNER GUN SPRUE
1 x NIGHT SPINNER CANNON MOUNT
1 x NIGHT SPINNER TURRET



ELDAR NIGHT SPINNER



ELDAR FIRE PRISM



FIRE PRISM HULL 1
030401301

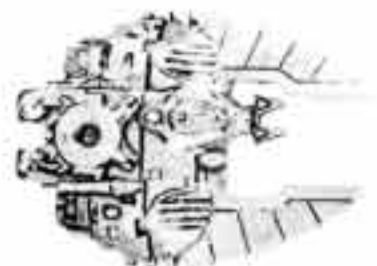

FIRE PRISM HULL 2
030401302



FIRE PRISM TURRET
030401303



ELDAR FIRE PRISM

A COMPLETE FIRE PRISM CONSISTS OF:
1 x FIRE PRISM HULL
1 x FIRE PRISM TURRET



Designed by Tim Adcock

EPIC 40,000

ELDAR SCORPION

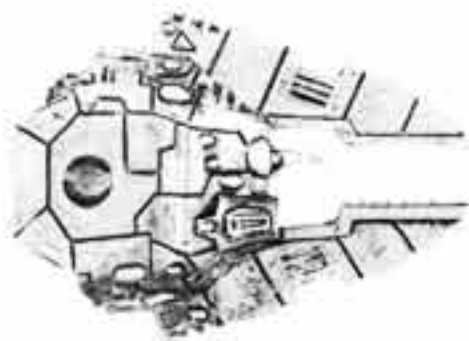

SCORPION HULL 1
030401101

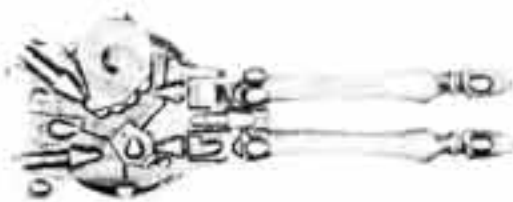

SCORPION PULSAR 1
030401102



SCORPION SHURIKEN CANNON TURRET
030401103



SCORPION HULL 2
030401104



SCORPION PULSAR 2
030401105



SCORPION LASCANNON TURRET
030401106



ELDAR SCORPION

A COMPLETE ELDAR SCORPION CONSISTS OF:
1 x SCORPION HULL
1 x SCORPION PULSAR
1 x SCORPION TURRET

ELDAR COBRA



COBRA HULL 1
030401001

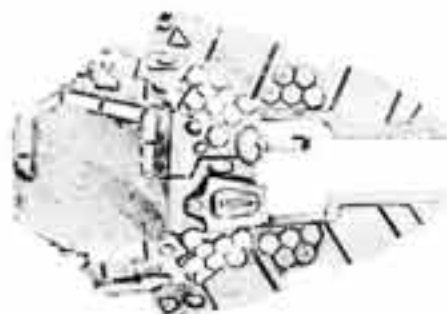

COBRA HULL 2
030401002

A COMPLETE ELDAR COBRA CONSISTS OF:
1 x COBRA HULL
1 x COBRA DISTORT CANNON



COBRA DISTORT CANNON
030401003



ELDAR COBRA



EPIC® 40,000

ELDAR VAMPIRE RAIDER

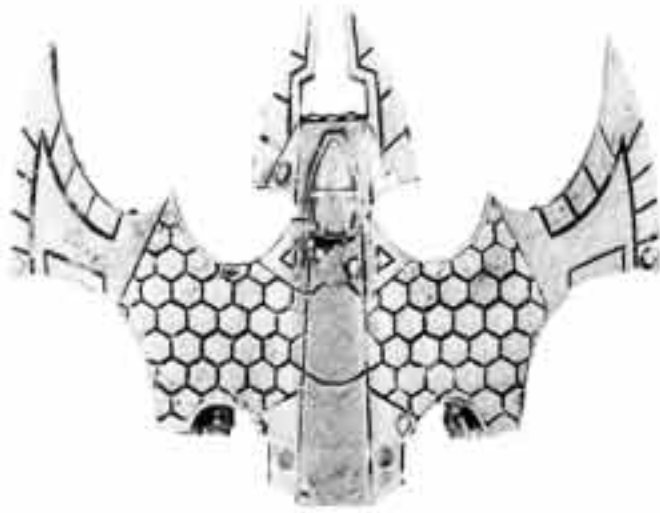

VAMPIRE RAIDER HULL
030401401



VAMPIRE RAIDER FOIL
030401404

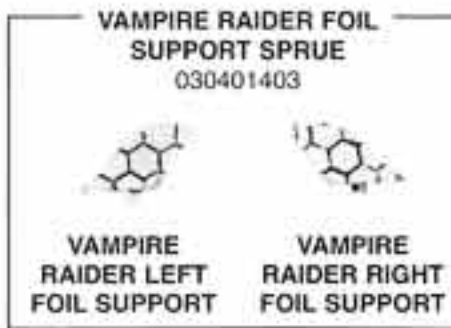

VAMPIRE RAIDER LEFT FOIL SUPPORT
VAMPIRE RAIDER RIGHT FOIL SUPPORT



ELDAR FLYER GUN SPRUE
030401402
ELDAR FLYER LEFT GUN
ELDAR FLYER RIGHT GUN



VAMPIRE RAIDER



A COMPLETE ELDAR VAMPIRE RAIDER CONSISTS OF:
1 x VAMPIRE RAIDER HULL
1 x VAMPIRE RAIDER FOIL
1 x ELDAR FLYER GUN SPRUE
1 x VAMPIRE RAIDER FOIL SUPPORT SPRUE

ELDAR PHOENIX BOMBER



PHOENIX BOMBER HULL
030401501



ELDAR FLYER GUN SPRUE
030401402
ELDAR FLYER LEFT GUN
ELDAR FLYER RIGHT GUN



PHOENIX BOMBER

ELDAR NIGHTWING INTERCEPTOR



ELDAR NIGHTWING INTERCEPTOR
030401601



ELDAR NIGHTWING INTERCEPTOR



A COMPLETE ELDAR PHOENIX BOMBER CONSISTS OF:
1 x PHOENIX BOMBER HULL
1 x ELDAR FLYER GUN SPRUE



Designed by Tim Adcock

EPIC 40,000

ELDAR REVENANT TITAN



REVENANT TITAN BACK FIN
030400401



REVENANT TITAN HEAD
030400402



REVENANT TITAN PULSE LASER
030400403



REVENANT TITAN NOSE GUN
030400406

A COMPLETE ELDAR REVENANT TITAN CONSISTS OF:

- 1 x REVENANT TITAN BACK FIN
- 1 x REVENANT TITAN WING
- 1 x REVENANT TITAN PULSE LASER SET
- 1 x REVENANT TITAN NOSE GUN
- 1 x REVENANT TITAN LEFT LEG
- 1 x REVENANT TITAN RIGHT LEG



REVENANT TITAN RIGHT LEG
030400404



REVENANT TITAN LEFT LEG
030400404

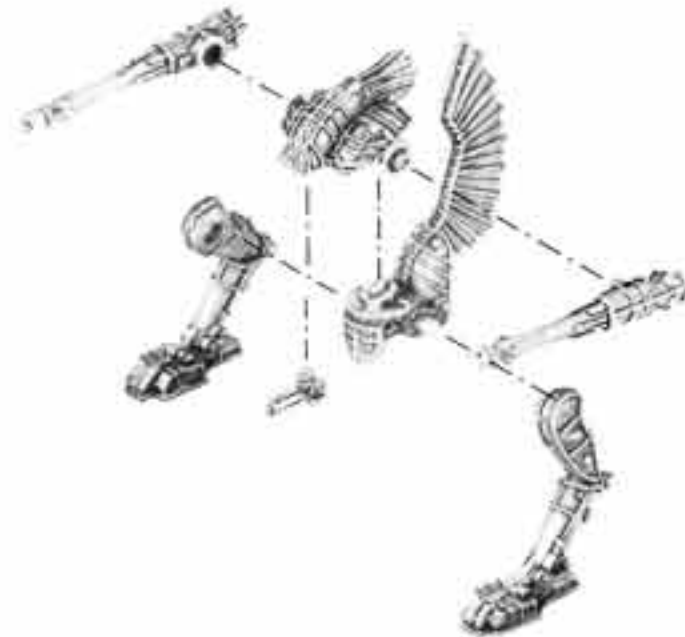

Designed by Dave Andrews



EPIC® 40,000

ELDAR PHANTOM TITAN



PHANTOM TITAN TORSO
030400301



PHANTOM TITAN WING
030400302



PHANTOM TITAN WAIST
030400303



PHANTOM TITAN HEAD
030400304



PHANTOM TITAN SHOULDER
030400305



DISTORTION CANNON
030400306



PULSAR
030400307



PHANTOM TITAN LEFT LEG
030400308



PHANTOM TITAN RIGHT LEG
030400309



PHANTOM TITAN LEFT FOOT
030400310



PHANTOM TITAN RIGHT FOOT
030400311

A COMPLETE ELDAR PHANTOM TITAN CONSISTS OF:

- 1 x PHANTOM TITAN BODY
- 2 x PHANTOM TITAN WING
- 1 x PHANTOM TITAN WAIST
- 1 x PHANTOM TITAN HEAD
- 1 x PHANTOM TITAN SHOULDER SET
- 1 x DISTORTION CANNON
- 1 x PULSAR
- 1 x PHANTOM TITAN LEFT LEG
- 1 x PHANTOM TITAN RIGHT LEG
- 1 x PHANTOM TITAN LEFT FOOT
- 1 x PHANTOM TITAN RIGHT FOOT



A COMPLETED
PHANTOM TITAN



Designed by Dave Andrews

Not suitable for children under 8 years due to small parts and essential pointed components. All models supplied unpainted.
© Copyright Games Workshop Ltd. 1998. All rights reserved.

EPIC® 40,000

EPIC CHAOS SPRUE

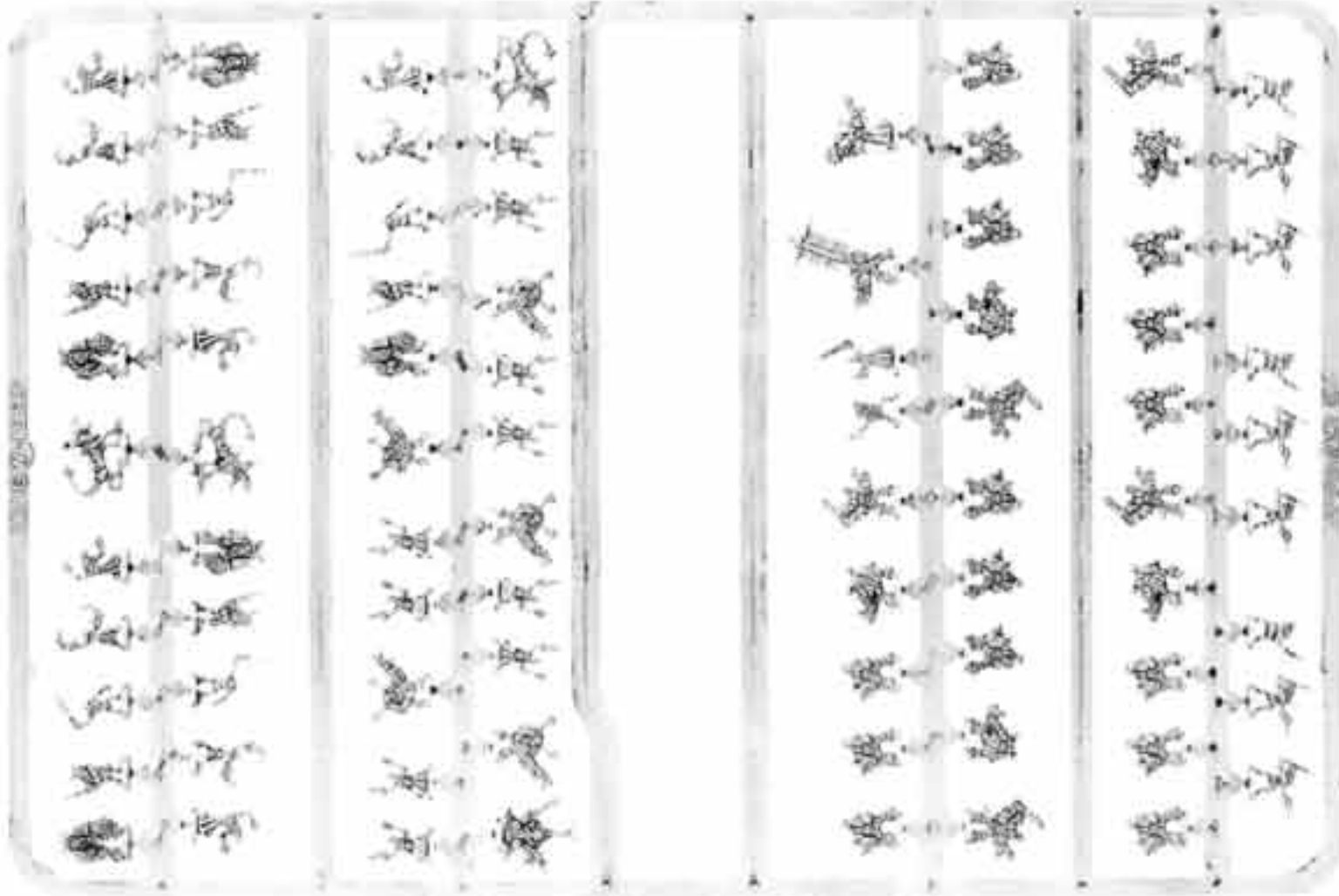

EPIC CHAOS SPRUE (SHOWN AT 60% OF ACTUAL SIZE)
9938999035

EPIC CHAOS SPRUE CONTENTS:

15 x CHAOS SPACE MARINES, 1 x CHAOS SPACE MARINE CHAMPION, 3 x CHAOS SPACE MARINE HEAVY BOLTER, 5 x CHAOS TERMINATORS, 5 x NOISE MARINES, 5 x KHORNE BERZERKERS, 1 x ICON BEARER, 1 x CHAOS SORCERER, 10 x CHAOS BEASTMEN, 10 x CHAOS CULTISTS, 1 x CHAOS CULTIST CHAMPION, 5 x PLAGUEBEARERS, 5 x BLOODLETTERS, 5 x FLAMERS, 5 x DAEMONETTES, 3 x FLESHHOUNDS

CHAOS PREDATORS

CHAOS PREDATOR
TRACKS 1
030200201

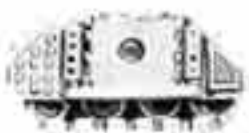

LEFT SIDE

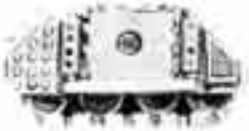

RIGHT SIDE

CHAOS PREDATOR
TRACKS 2
030200202



LEFT SIDE



RIGHT SIDE

CHAOS PREDATOR
TRACKS 3
030200203



LEFT SIDE



RIGHT SIDE

CHAOS PREDATOR SPONSONS



LEFT SIDE
HEAVY BOLTER
SPONSON
030200320



RIGHT SIDE
HEAVY BOLTER
SPONSON
030200315



LEFT SIDE
HEAVY PLASMA
SPONSON
030200318



RIGHT SIDE
HEAVY PLASMA
SPONSON
030200318



LEFT SIDE
HEAVY FLAMER
SPONSON
030200319



RIGHT SIDE
HEAVY FLAMER
SPONSON
030200317



LEFT SIDE
LASCANNON
SPONSON
030200313

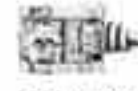

RIGHT SIDE
LASCANNON
SPONSON
030200314



CHAOS PREDATOR
TURRET 1
030200310



CHAOS PREDATOR
TURRET 2
030200311



CHAOS PREDATOR
TURRET 3
030200312



STORM BOLTER
030200107

A COMPLETE CHAOS PREDATOR
CONSISTS OF:
1 x CHAOS PREDATOR HULL
1 x CHAOS PREDATOR TRACKS
1 x SET OF
CHAOS PREDATOR SPONSONS
1 x CHAOS RAM BAR
1 x STORM BOLTER



CHAOS PREDATOR
HULL 1
030200204



CHAOS PREDATOR
HULL 2
030200205



CHAOS PREDATOR
HULL 3
030200206



CHAOS PREDATOR



EPIC® 40,000

CHAOS RHINOS

CHAOS RHINO
TRACKS 1
030200101

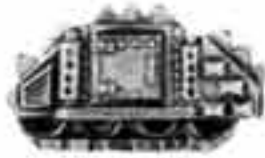

LEFT SIDE



RIGHT SIDE

CHAOS RHINO
TRACKS 2
030200102



LEFT SIDE



RIGHT SIDE

CHAOS RHINO
TRACKS 3
030200103



LEFT SIDE



RIGHT SIDE



CHAOS RAM BAR 1
030200108



CHAOS RAM BAR 2
030200109



STORM BOLTER
030200107

A COMPLETE CHAOS RHINO
CONSISTS OF:
1 x CHAOS RHINO HULL
1 x CHAOS RHINO TRACKS
1 x CHAOS RAM BAR
1 x STORM BOLTER



CHAOS RHINO HULL 1
030200104



CHAOS RHINO HULL 2
030200105



CHAOS RHINO HULL 3
030200106



CHAOS RHINO

CHAOS LAND RAIDERS



CHAOS LAND RAIDER
HULL 1
030200314



CHAOS LAND RAIDER
HULL 2
030200315



CHAOS LAND RAIDER
HULL 3
030200313



STORM BOLTER
030200107



LEFT SIDE
TWIN LASCANNON 1
030200308



RIGHT SIDE
TWIN LASCANNON 1
030200309



LEFT SIDE



RIGHT SIDE

TWIN LASCANNON 2
030200310

CHAOS LAND RAIDER
TRACKS 1
030200301



LEFT SIDE



RIGHT SIDE

CHAOS LAND RAIDER
TRACKS 2
030200302

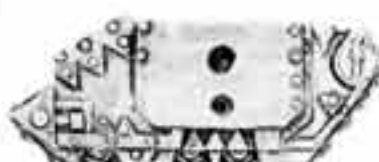

LEFT SIDE



RIGHT SIDE

CHAOS LAND RAIDER
TRACKS 3
030200303

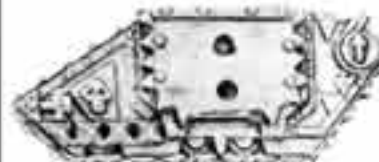

LEFT SIDE



RIGHT SIDE



LEFT SIDE
TWIN LASCANNON 3
030200312

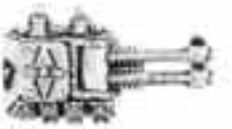

RIGHT SIDE
TWIN LASCANNON 3
030200311

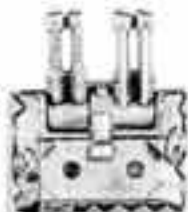

CHAOS LAND RAIDER
TURRET
030200307



CHAOS LAND RAIDER
TOP PLATE 1
030200304

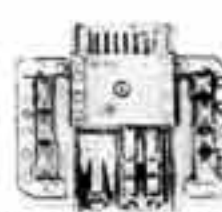

CHAOS LAND RAIDER
TOP PLATE 2
030200305



CHAOS LAND RAIDER
TOP PLATE 3
030200306

A COMPLETE CHAOS LAND RAIDER CONSISTS OF:

1 x CHAOS LAND RAIDER HULL
1 x CHAOS LAND RAIDER TRACKS
1 x CHAOS LAND RAIDER HULL

1 x CHAOS LAND RAIDER TOP PLATE
1 x SET OF TWIN LASCANNONS
1 x STORM BOLTER

PLEASE NOTE THAT THIS
COMPONENT WILL ONLY
FIT CHAOS LAND RAIDER
TOP PLATE 1



CHAOS LAND RAIDER



CITADEL
MINIATURES



CITADEL
MINIATURES

Designed by Tim Adcock

Not suitable for children under 36 months due to small parts and essential pointed components. All models supplied unpainted.

© Copyright Games Workshop Ltd. 1998. All rights reserved.

EPIC® 40,000

IMPERIAL SHADOWSWORD

SHADOWSWORD TRACKS
030500501



RIGHT TRACK



LEFT TRACK



SHADOWSWORD HULL
030500502



SHADOWSWORD CANNON
030500504



RIGHT SPONSON
030500505



LEFT SPONSON
030500506

IMPERIAL HATCHES
030100115



SHADOWSWORD TURRET
030500503

A COMPLETED IMPERIAL SHADOWSWORD
CONSISTS OF:

- 1 x SET OF SHADOWSWORD TRACKS
- 1 x SET OF SHADOWSWORD SPONSONS
- 1 x SHADOWSWORD HULL
- 1 x SHADOWSWORD CANNON
- 1 x SHADOWSWORD TURRET
- 1 x IMPERIAL HATCH

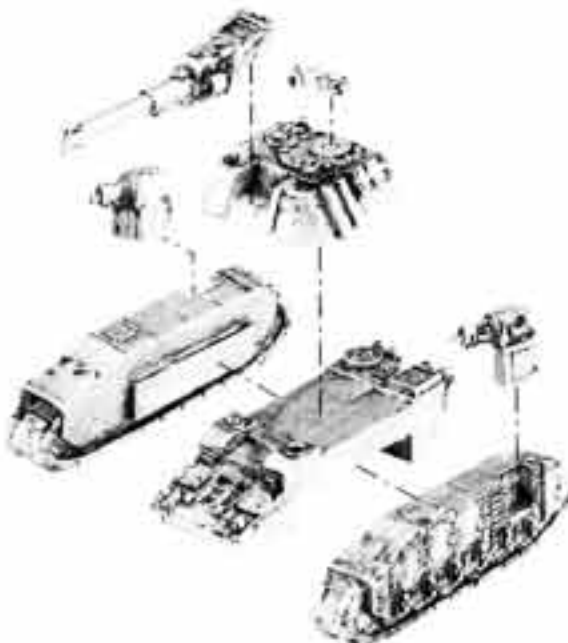

IMPERIAL SHADOWSWORDS

Designed by Tim Adcock



EPIC® 40,000

IMPERIAL BANEBLADE SUPER HEAVY TANK



HULL 1
030500302



HULL 2
030500307



HULL 3
030500308

TRACKS 1
030500301

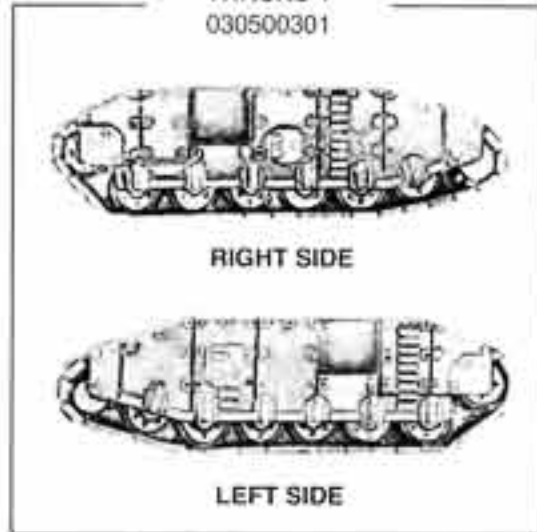

RIGHT SIDE

LEFT SIDE

TRACKS 2
030500312

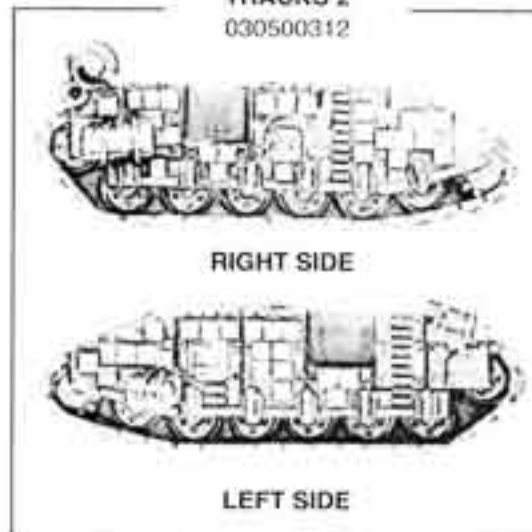

RIGHT SIDE

LEFT SIDE

TRACKS 3
030500313

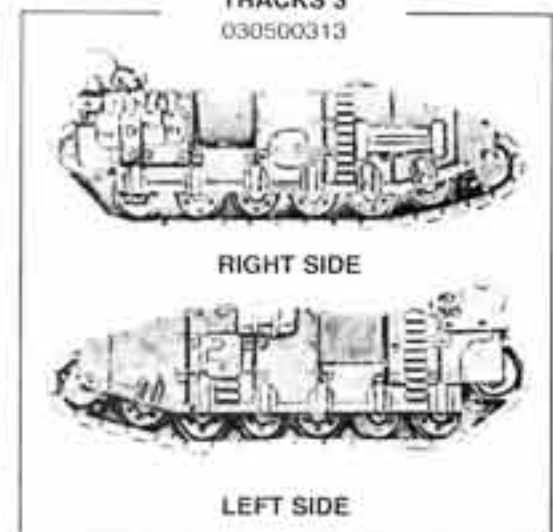

RIGHT SIDE

LEFT SIDE

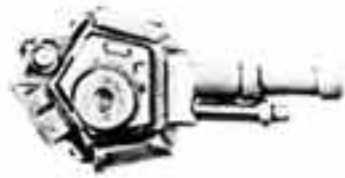

BATTLE CANNON TURRET 1
030500303

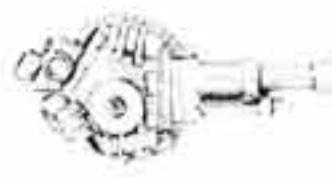

BATTLE CANNON TURRET 2
030500315



BATTLE CANNON TURRET 3
030500314



LEFT SIDE
LASCANNON 1
030500305



RIGHT SIDE
LASCANNON 1
030500306



LEFT SIDE
LASCANNON 2
030500318



RIGHT SIDE
LASCANNON 2
030500316



LEFT SIDE
LASCANNON 3
030500319



RIGHT SIDE
LASCANNON 3
030500317



HEAVY BOLTER
TURRET
030500304

IMPERIAL HATCHES
030100115



IMPERIAL BANEBLADE SUPER HEAVY TANK

Parts from the Imperial Baneblade battle tank are interchangeable. For example, you could choose tracks 3 to go with hull 1, turret 2, etc, creating your own Baneblade combinations as we have done with this example.

A COMPLETE IMPERIAL BANEBLADE CONSISTS OF:
1 x HULL
1 x BATTLE CANNON TURRET
1 x SET OF TRACKS
1 x HEAVY BOLTER TURRET
1 x RIGHT SIDE LASCANNON
1 x LEFT SIDE LASCANNON
1 x HATCH



Designed by Tim Adcock

EPIC® 40,000

IMPERIAL LEMAN RUSS BATTLE TANK



LEMAN RUSS HULL 1
030500105



LEMAN RUSS HULL 2
030500106



LEMAN RUSS HULL 3
030500107



LEMAN RUSS HULL 4
030500108

LEMAN RUSS TRACKS 1
030500101

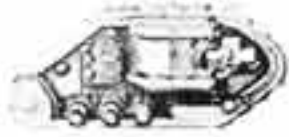

RIGHT SIDE



LEFT SIDE

LEMAN RUSS TRACKS 2
030500102



RIGHT SIDE



LEFT SIDE

LEMAN RUSS TRACKS 3
030500103



RIGHT SIDE

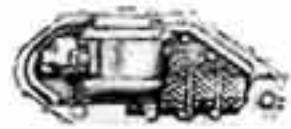

LEFT SIDE

LEMAN RUSS TRACKS 4
030500104



RIGHT SIDE



LEFT SIDE



BULLDOZER BLADE 1
030100112



BULLDOZER BLADE 2
030100113



BULLDOZER BLADE 3
030100114



IMPERIAL HATCHES
030100115



LEMAN RUSS TURRET 1
030500109



LEMAN RUSS TURRET 2
030500110



LEMAN RUSS TURRET 3
030500111



LEMAN RUSS TURRET 4
030500112



LEMAN RUSS TURRET 5
030500113

A COMPLETE IMPERIAL
LEMAN RUSS BATTLE TANK
CONSISTS OF:

- 1 x LEMAN RUSS HULL
- 1 x SET OF LEMAN RUSS TRACKS
- 1 x LEMAN RUSS TURRET
- 1 x BULLDOZER BLADE
- 1 x IMPERIAL HATCH

IMPERIAL LEMAN RUSS DEMOLISHER

LEMAN RUSS
DEMOLISHER TRACKS
030500609



RIGHT SIDE



LEFT SIDE



LEMAN RUSS
DEMOLISHER TURRET
030500610

A COMPLETE IMPERIAL
LEMAN RUSS DEMOLISHER
CONSISTS OF:

- 1 x LEMAN RUSS HULL
- 1 x SET OF LEMAN RUSS DEMOLISHER TRACKS
- 1 x LEMAN RUSS DEMOLISHER TURRET
- 1 x BULLDOZER BLADE
- 1 x IMPERIAL HATCH



IMPERIAL LEMAN RUSS BATTLE TANKS

IMPERIAL SENTINEL



IMPERIAL SENTINEL'S
LEGS
030501201



IMPERIAL SENTINEL'S
COCKPIT
030501202



IMPERIAL SENTINEL



LEMAN RUSS DEMOLISHER



EPIC® 40,000

IMPERIAL CHIMERA

IMPERIAL TRACKS 1
030500401



LEFT SIDE



RIGHT SIDE

IMPERIAL TRACKS 2
030500206



LEFT SIDE



RIGHT SIDE

IMPERIAL TRACKS 3
030500207



LEFT SIDE



RIGHT SIDE

IMPERIAL TRACKS 4
030500208



LEFT SIDE



RIGHT SIDE

IMPERIAL TRACKS 5
030500209



LEFT SIDE



RIGHT SIDE



CHIMERA HULL 1
030500702



CHIMERA HULL 2
030500703



CHIMERA HULL 3
030500704



CHIMERA HULL 4
030500705



CHIMERA TURRET 1
030500710



CHIMERA TURRET 2
030500711



CHIMERA TURRET 3
030500712



CHIMERA TURRET 4
030500713



CHIMERA TURRET 5
030500714



BULLDOZER BLADE 1
030100112



BULLDOZER BLADE 2
030100113



BULLDOZER BLADE 3
030100114

A COMPLETE IMPERIAL CHIMERA CONSISTS OF:

- 1 x SET OF IMPERIAL TRACKS
- 1 x CHIMERA HULL
- 1 x CHIMERA TURRET
- 1 x BULLDOZER BLADE
- 1 x HATCH SPRUE

IMPERIAL HATCH SPRUE
030100115



STORM BOLTER HATCH



SEARCHLIGHT HATCH



HATCH



IMPERIAL CHIMERA

IMPERIAL HEAVY MORTAR GRIFFON

IMPERIAL TRACKS 1
030500401



LEFT SIDE



RIGHT SIDE

IMPERIAL TRACKS 2
030500206



LEFT SIDE



RIGHT SIDE

IMPERIAL TRACKS 3
030500207



LEFT SIDE



RIGHT SIDE

IMPERIAL TRACKS 4
030500208



LEFT SIDE



RIGHT SIDE

IMPERIAL TRACKS 5
030500209



LEFT SIDE



RIGHT SIDE

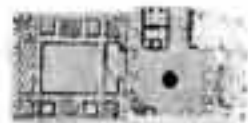

GRIFFON HULL 1
030500902



GRIFFON HULL 2
030500903



GRIFFON HULL 3
030500904



GRIFFON HULL 4
030500905



GRIFFON HEAVY MORTAR
030500910



BULLDOZER BLADE 1
030100112



BULLDOZER BLADE 2
030100113



BULLDOZER BLADE 3
030100114

A COMPLETE IMPERIAL GRIFFON HEAVY MORTAR CONSISTS OF:

- 1 x SET OF IMPERIAL TRACKS
- 1 x GRIFFON HEAVY MORTAR HULL
- 1 x GRIFFON HEAVY MORTAR
- 1 x BULLDOZER BLADE



IMPERIAL HEAVY MORTAR GRIFFON



Designed by Tim Adcock

Not suitable for children under 8 years due to small parts and essential pointed components. All models supplied unpainted.
© Copyright Games Workshop Ltd 1998. All rights reserved.

EPIC® 40,000

IMPERIAL HELLHOUND FLAME TANKS

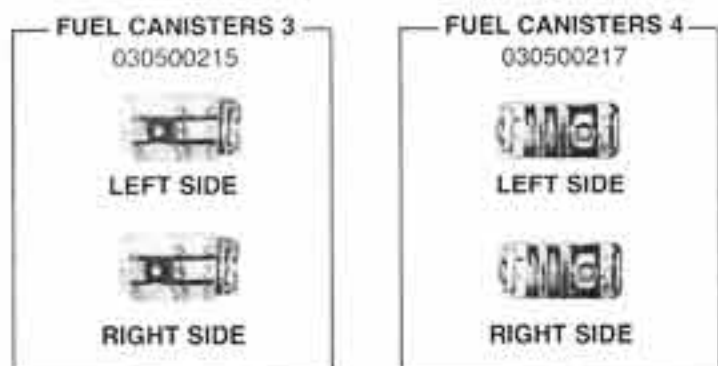
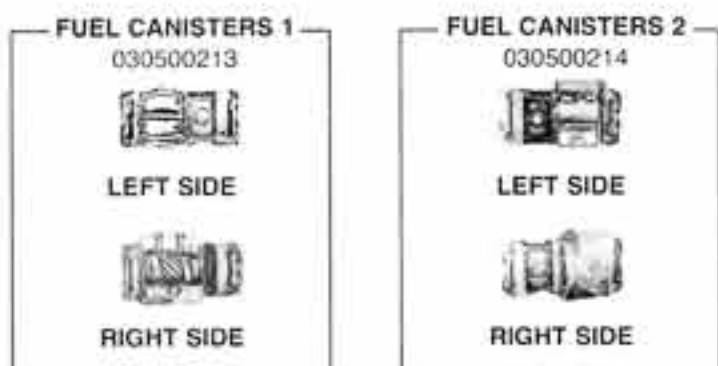
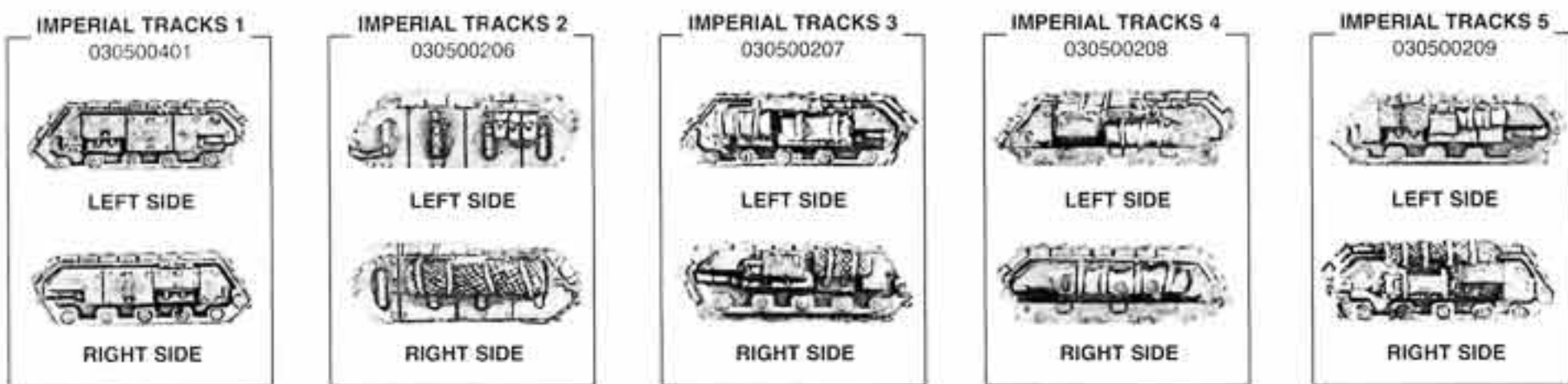

A COMPLETED IMPERIAL HELLHOUND FLAME TANK CONSISTS OF:
 1 x SET OF IMPERIAL TRACKS
 1 x BULLDOZER BLADE
 1 x HELLHOUND TURRET
 1 x SET OF FUEL CANISTERS
 1 x HULL



Parts from the Imperial Hellhound are interchangeable. For example, you could choose Imperial tracks 3 to go with hull 1, fuel canisters 2, etc. creating your own Hellhound combinations as we have done with these examples above.

Designed by Tim Adcock



EPIC® 40,000

IMPERIAL DEATHSTRIKE MISSILE LAUNCHER

IMPERIAL TRACKS 1
030500401



LEFT SIDE



RIGHT SIDE

IMPERIAL TRACKS 2
030500206



LEFT SIDE



RIGHT SIDE

IMPERIAL TRACKS 3
030500207



LEFT SIDE



RIGHT SIDE

IMPERIAL TRACKS 4
030500208



LEFT SIDE



RIGHT SIDE

IMPERIAL TRACKS 5
030500209



LEFT SIDE



RIGHT SIDE



DEATHSTRIKE
MISSILE LAUNCHER MISSILE
030101103

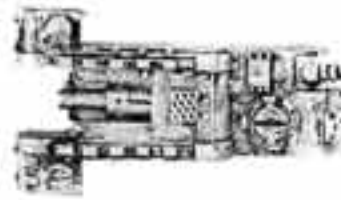

DEATHSTRIKE
MISSILE LAUNCHER HULL
030101102



DEATHSTRIKE
MISSILE LAUNCHER RAMP
030101104



BULLDOZER BLADE 1
030100112



DEATHSTRIKE MISSILE LAUNCHER

A COMPLETE IMPERIAL DEATHSTRIKE MISSILE LAUNCHER CONSISTS OF:

- 1 x SET OF IMPERIAL TRACKS
- 1 x BULLDOZER BLADE
- 1 x DEATHSTRIKE MISSILE LAUNCHER MISSILE
- 1 x DEATHSTRIKE MISSILE LAUNCHER HULL
- 1 x DEATHSTRIKE MISSILE LAUNCHER RAMP

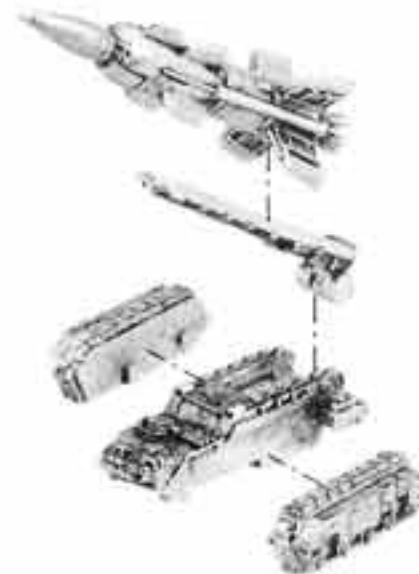

BULLDOZER BLADE 2
030100113



BULLDOZER BLADE 3
030100114

Designed by Tim Adcock



EPIC® 40,000

IMPERIAL HYDRA FLAK TANKS

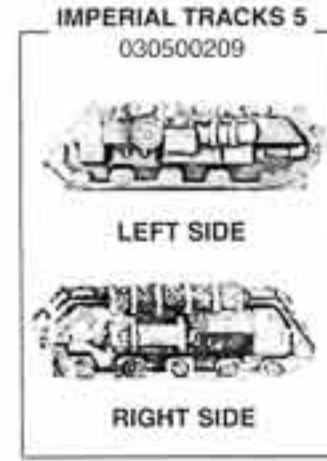
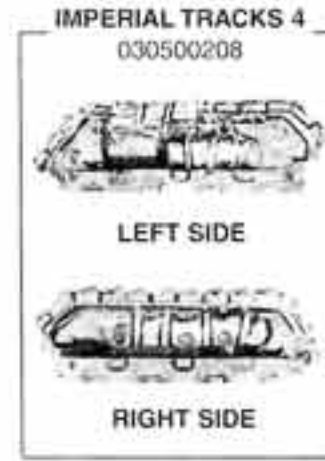
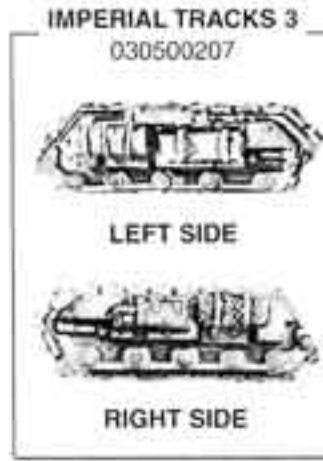
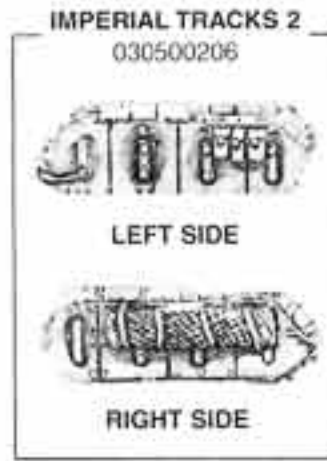
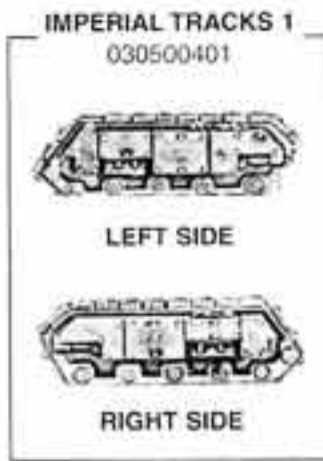

HYDRA HULL
030500801



HYDRA TURRET
030500804



HYDRA RIGHT FLAK GUNS
030500803



HYDRA LEFT FLAK GUNS
030500802



HYDRA RADAR
030500805

A COMPLETE IMPERIAL HYDRA FLAK TANK CONSISTS OF:

- 1 x SET OF IMPERIAL TRACKS
- 1 x HYDRA HULL
- 1 x HYDRA TURRET
- 1 x HYDRA RIGHT FLAK GUNS
- 1 x HYDRA LEFT FLAK GUNS
- 1 x HYDRA RADAR



HYDRA FLAK TANK

IMPERIAL SIEGE ARTILLERY BOMBARD

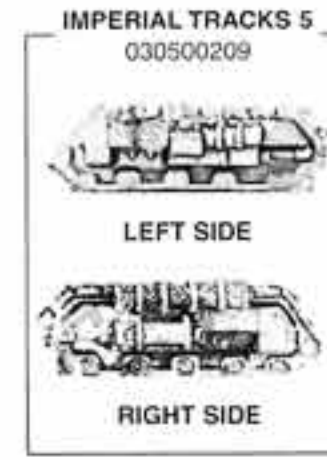
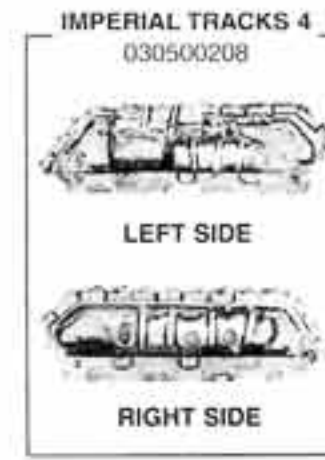
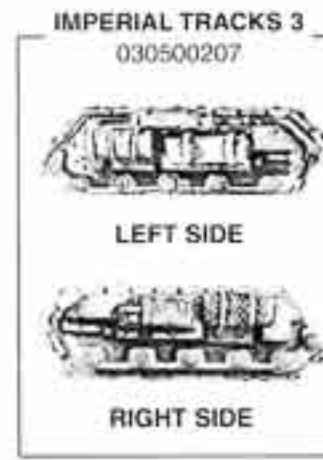
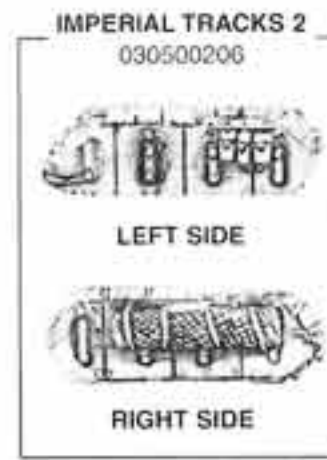
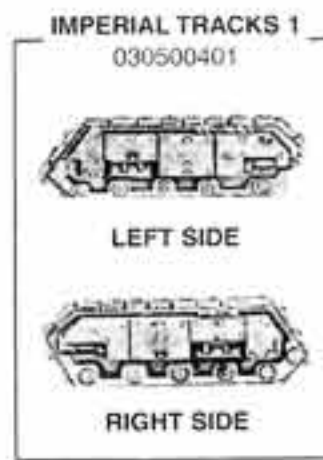

BOMBARD HULL
030501302

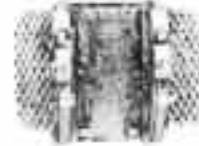

BOMBARD PLATFORM
030501303



BOMBARD CANNON
030501304



BOMBARD SHELL HOIST
030501305



BULLDOZER BLADE 1
030100112



BULLDOZER BLADE 2
030100113



BULLDOZER BLADE 3
030100114

A COMPLETE IMPERIAL BOMBARD CONSISTS OF:

- 1 x SET OF IMPERIAL TRACKS
- 1 x BOMBARD HULL
- 1 x BOMBARD PLATFORM
- 1 x BOMBARD CANNON
- 1 x BOMBARD SHELL HOIST
- 1 x BULLDOZER BLADE



IMPERIAL BOMBARD



EPIC® 40,000

IMPERIAL BASILISK ASSAULT GUN



**EARTHSHAKER
CANNON 1**
030500406



**EARTHSHAKER
CANNON 2**
030500407



**EARTHSHAKER
CANNON 3**
030500408



**EARTHSHAKER
CANNON 4**
030500409



HULL 1
030500402



HULL 2
030500403



HULL 3
030500404



HULL 4
030500405

IMPERIAL TRACKS 1
030500401



LEFT SIDE



RIGHT SIDE

IMPERIAL TRACKS 2
030500205



LEFT SIDE



RIGHT SIDE

IMPERIAL TRACKS 3
030500206



LEFT SIDE



RIGHT SIDE

IMPERIAL TRACKS 4
030500207



LEFT SIDE

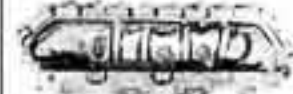

RIGHT SIDE

IMPERIAL TRACKS 5
030500208



LEFT SIDE



RIGHT SIDE



BULLDOZER BLADE 1
030100112



BULLDOZER BLADE 3
030100114

**A COMPLETED IMPERIAL
BASILISK ASSAULT GUN
CONSISTS OF:**
1 x HULL
1 x BULLDOZER BLADE
1 x IMPERIAL TRACKS
1 x EARTHSHAKER CANNON

Parts from the Imperial Basilisk assault gun are interchangeable. For example, you could choose Imperial tracks 1 to go with hull 3, earthshaker cannon 2, etc, creating your own Basilisk combinations as we have done with these examples below.

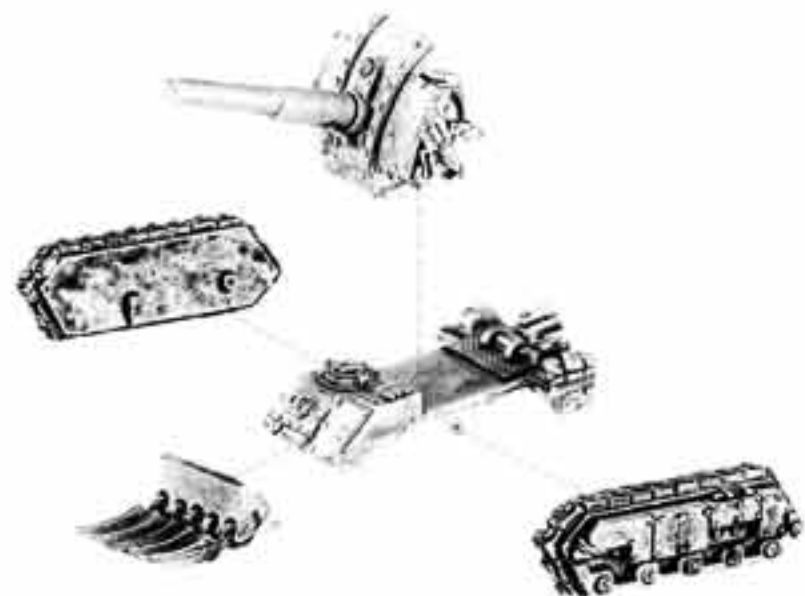

IMPERIAL BASILISK ASSAULT GUNS

Designed by Tim Adcock

EPIC® 40,000

IMPERIAL MANTICORE

IMPERIAL TRACKS 1
030500401



LEFT SIDE

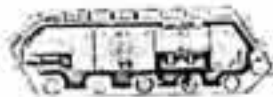

RIGHT SIDE

IMPERIAL TRACKS 2
030500206



LEFT SIDE



RIGHT SIDE

IMPERIAL TRACKS 3
030500207



LEFT SIDE



RIGHT SIDE

IMPERIAL TRACKS 4
030500208



LEFT SIDE



RIGHT SIDE

IMPERIAL TRACKS 5
030500209



LEFT SIDE



RIGHT SIDE



MANTICORE
MISSILE LAUNCHER
030501003

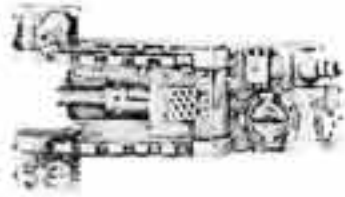

DEATHSTRIKE
MISSILE LAUNCHER HULL
030501102



BULLDOZER BLADE 1
030100112



BULLDOZER BLADE 2
030100113



BULLDOZER BLADE 3
030100114

MANTICORE
MISSILE SPRUE
030501004



A COMPLETE IMPERIAL MANTICORE
CONSISTS OF:
1 x SET OF IMPERIAL TRACKS
1 x DEATHSTRIKE MISSILE LAUNCHER HULL
1 x MANTICORE MISSILE LAUNCHER
2 x MANTICORE MISSILE SPRUES



IMPERIAL MANTICORE

IMPERIAL MARAUDER BOMBER



MARAUDER
BOMBER HULL
030501401

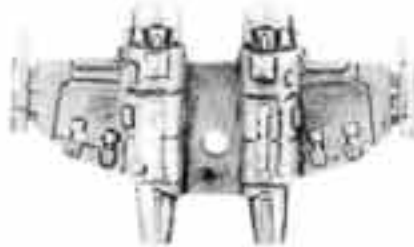

MARAUDER
BOMBER WINGS
030501402

MARAUDER BOMBER
MISSILE SPRUE
030501403



MARAUDER BOMBER
TAIL WING
030501404

A COMPLETE IMPERIAL MARAUDER BOMBER
CONSISTS OF:
1 x MARAUDER BOMBER HULL
1 x MARAUDER BOMBER WINGS
1 x MARAUDER BOMBER TAIL WING
1 x MARAUDER BOMBER MISSILE SPRUE



MARAUDER BOMBER



THUNDERBOLT FIGHTERS

THUNDERBOLT
FIGHTER MISSILE
SPRUE 1
030501503



THUNDERBOLT
FIGHTER MISSILE
SPRUE 2
030501504



THUNDERBOLT
FIGHTER MISSILE
SPRUE 3
030501505



THUNDERBOLT FIGHTER
HULL
030501501

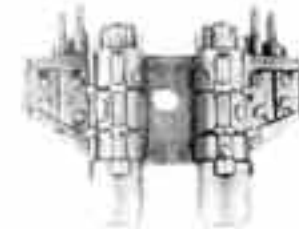

THUNDERBOLT FIGHTER
WINGS
030501502

A COMPLETE IMPERIAL THUNDERBOLT FIGHTER
CONSISTS OF:
1 x THUNDERBOLT FIGHTER HULL
1 x THUNDERBOLT FIGHTER WINGS
1 x THUNDERBOLT FIGHTER MISSILE SPRUE



THUNDERBOLT FIGHTER



EPIC® 40,000

ORK BATTLE FORTRESS

ORK BATTLE FORTRESS
TRACKS 1
030301205

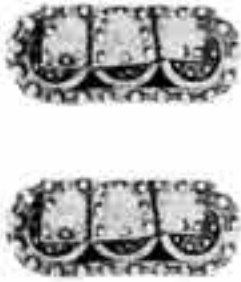

ORK BATTLE FORTRESS
TRACKS 2
030301206



ORK BATTLE FORTRESS
TRACKS 3
030301207

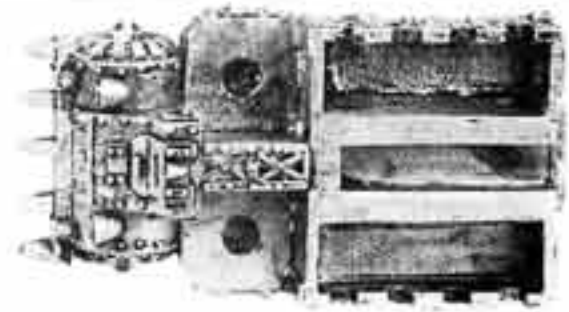
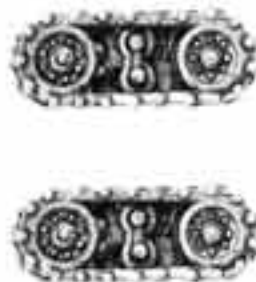

ORK BATTLE FORTRESS CHASSIS 1
030301201

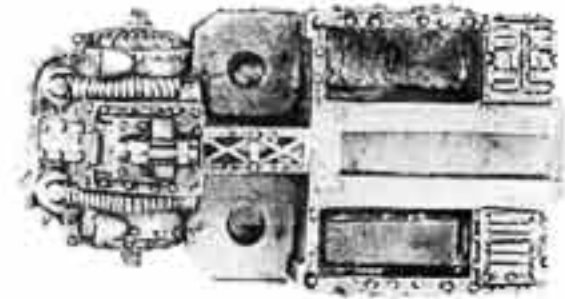

ORK BATTLE FORTRESS CHASSIS 2
030301217

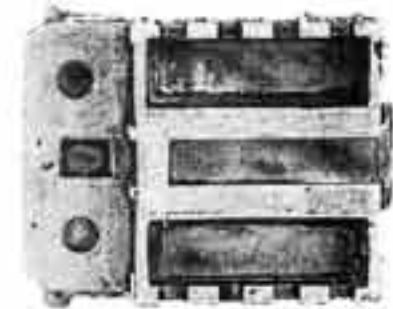

ORK BATTLE FORTRESS CHASSIS 3
030301202

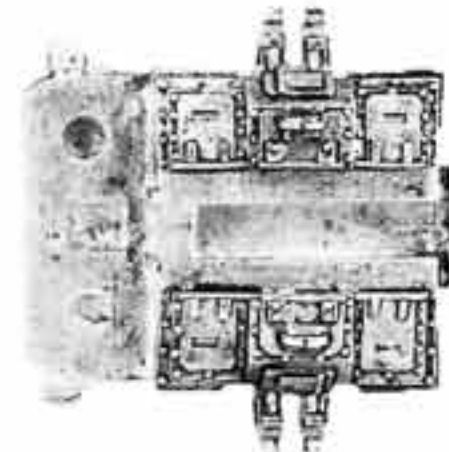

ORK BATTLE FORTRESS CHASSIS 4
030301212



ORK BATTLE FORTRESS
ENGINE 1
030301211

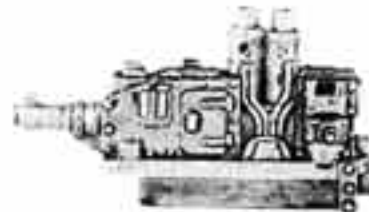

ORK BATTLE FORTRESS
ENGINE 2
030301215

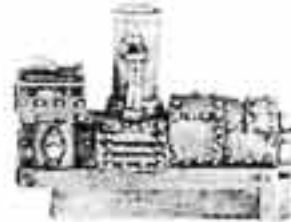

ORK BATTLE FORTRESS
ENGINE 3
030301216



ORK BATTLE FORTRESS
ROLLER 1
030301203

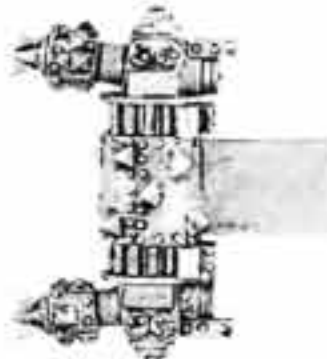

ORK BATTLE FORTRESS
ROLLER 2
030301213

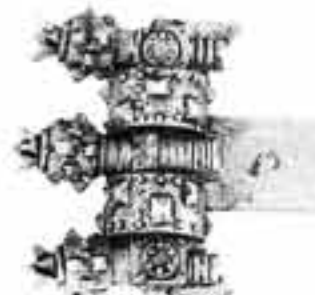

ORK BATTLE FORTRESS
ROLLER 3
030301218



ORK BATTLE FORTRESS
TURRET 1
030301208



ORK BATTLE FORTRESS
TURRET 2
030301209



ORK BATTLE FORTRESS
TURRET 3
030301210



ORK BATTLE FORTRESS
FRONT TURRET 1
030301204



ORK BATTLE FORTRESS
FRONT TURRET 2
030301214

A COMPLETED ORK BATTLE
FORTRESS 1 AND 2 CONSISTS OF:
1 x ORK BATTLE FORTRESS
CHASSIS 1 OR 2
2 x ORK BATTLE FORTRESS TURRETS
1 x SET OF ORK BATTLE FORTRESS
TRACKS
1 x ORK BATTLE FORTRESS ENGINE

A COMPLETED ORK BATTLE
FORTRESS 3 AND 4 CONSISTS OF:
1 x ORK BATTLE FORTRESS
CHASSIS 3 OR 4
1 x ORK BATTLE FORTRESS ROLLER
1 x ORK BATTLE FORTRESS
FRONT TURRET
2 x ORK BATTLE FORTRESS TURRETS
1 x SET OF ORK BATTLE FORTRESS
TRACKS
1 x ORK BATTLE FORTRESS ENGINE



ORK BATTLE FORTRESS

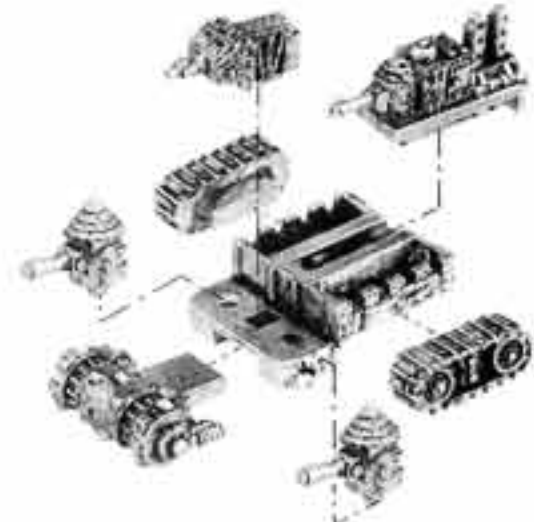
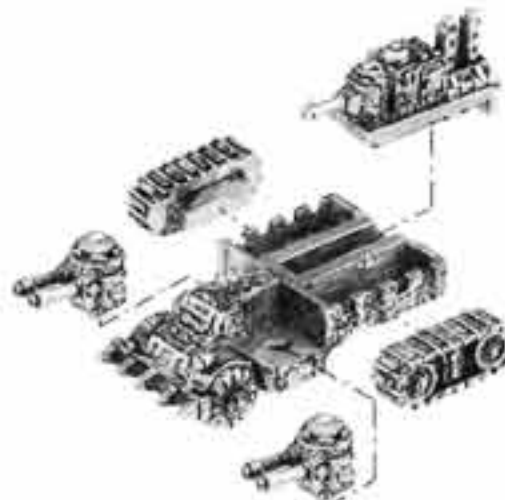

Designed by Norman Swales

Not suitable for children under 8 years due to small parts and essential pointed components. All models supplied unpainted.
© Copyright Games Workshop Ltd. 1998. All rights reserved.

EPIC® 40,000

ORK FLAKWAGON

ORK FLAKWAGON
TRACKS 1
030301302



RIGHT TRACK



LEFT TRACK

ORK FLAKWAGON
TRACKS 2
030301306



RIGHT TRACK



LEFT TRACK

ORK FLAKWAGON
TRACKS 3
030301307

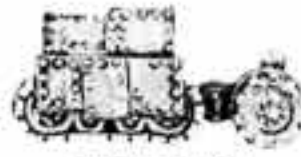

RIGHT TRACK



LEFT TRACK



ORK FLAKWAGON HULL 1
030301301



ORK FLAKWAGON HULL 2
030301304



ORK FLAKWAGON HULL 3
030301305

ORK FLAKWAGON
GUN SPRUE 1
030301303



RIGHT GUN



LEFT GUN

ORK FLAKWAGON
GUN SPRUE 2
030301308



RIGHT GUN



LEFT GUN

ORK FLAKWAGON
GUN SPRUE 3
030301309



UPPER GUN



LOWER GUN

A COMPLETE ORK FLAKWAGON
CONSIST OF:
1 x ORK FLAKWAGON HULL
1 x SET OF ORK FLAKWAGON TRACKS
1 x SET OF ORK FLAKWAGON GUNS

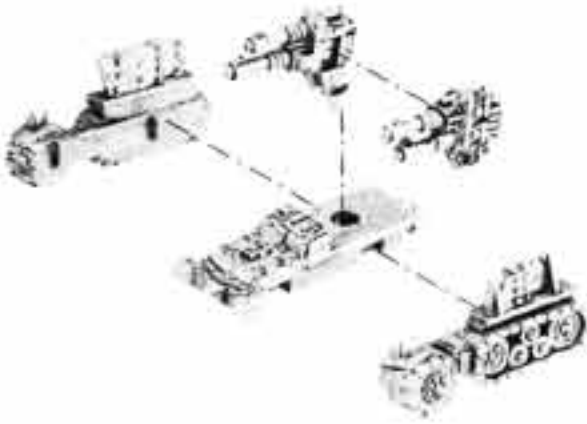

ORK FLAKWAGONS



ORK DREADNOUGHTS



ORK DREADNOUGHT 1
030301001



ORK DREADNOUGHT 2
030301002

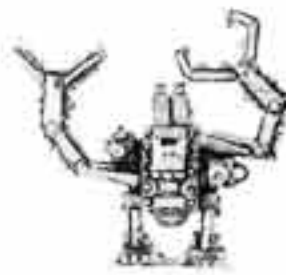

ORK DREADNOUGHT 3
030301003



ORK DREADNOUGHT 4
030301004



ORK DREADNOUGHTS



EPIC® 40,000

ORK SPEEDSTAS



ORK SPEEDSTA CHASSIS 1
030300902

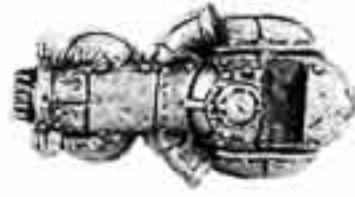

ORK SPEEDSTA CHASSIS 2
030300905



ORK SPEEDSTA CHASSIS 3
030300907



ORK SPEEDSTA LIFTA DROPPA
030300903



ORK SPEEDSTA DEATH RAY
030300908



ORK SPEEDSTA WITH LIFTA DROPPA

A COMPLETE ORK SPEEDSTA
CONSISTS OF:
1 x ORK SPEEDSTA CHASSIS
1 x ORK SPEEDSTA WEAPON



ORK FIGHTA-BOMMERZ



ORK FIGHTA-BOMMER 1
030300701



ORK FIGHTA-BOMMER 2
030300703

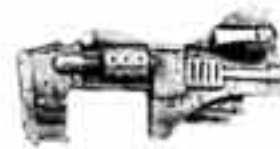

ORK FIGHTA-BOMMER 3
030300705

ORK FIGHTA-BOMMER
MISSILE SPRUE
030300707



MISSILES



ORK FIGHTA-BOMMER
WINGS 1
030300702



ORK FIGHTA-BOMMER
WINGS 2
030300704



ORK FIGHTA-BOMMER
WINGS 3
030300706



A COMPLETE ORK FIGHTA-BOMMER CONSISTS OF:
1 x ORK FIGHTA-BOMMER
1 x ORK FIGHTA-BOMMER WINGS
1 x SET OF ORK FIGHTA-BOMMER MISSILES

ORK FIGHTA-BOMMER



Fighta-Bommerz designed by Dave Andrews

Not suitable for children under 36 months due to small parts and essential pointed components. All models supplied unpainted.
© Copyright Games Workshop Ltd., 1997. All rights reserved.

EPIC® 40,000

ORK SCORCHERS



ORK SCORCHER 1
030300602



ORK SCORCHER 2
030300603



ORK SCORCHER FUEL
TANK 1
030300604



ORK SCORCHER FUEL
TANK 2
030300605



ORK SCORCHER FUEL
TANK 3
030300606

ORK TRACK SPRUE
030300501



RIGHT TRACK



LEFT TRACK



A COMPLETE ORK SCORCHER
CONSISTS OF:
1 x ORK SCORCHER
1 x ORK SCORCHER FUEL TANK
1 x SET OF ORK TRACKS

ORK SCORCHERS

ORK PULSA ROKKITS



ORK PULSA ROKKIT
LAUNCHER 1
030300801



ORK PULSA ROKKIT
LAUNCHER 2
030300802



ORK PULSA ROKKIT
LAUNCHER 3
030300803



ORK PULSA ROKKIT 1
030300804



ORK PULSA ROKKIT 2
030300805



ORK PULSA ROKKIT 3
030300806



ORK PULSA ROKKIT 4
030300807

A COMPLETE ORK
PULSA ROKKIT
CONSISTS OF:
1 x ORK PULSA ROKKIT
LAUNCHER
1 x ORK PULSA ROKKIT

ORK WARTRAKS



ORK WARTRAK WITH
'EAVY FLAMER
030300502

ORK TRACK SPRUE
030300501



RIGHT TRACK



LEFT TRACK



A COMPLETE ORK WARTRAK
CONSISTS OF:
1 x ORK WARTRAK
1 x SET OF ORK TRACKS



ORK WARTRAK WITH
'EAVY BOLTA
030300503



ORK WARTRAK WITH
AUTO KANNON
030300504



Designed by Norman Swales

EPIC® 40,000

ORK MOB SPRUE

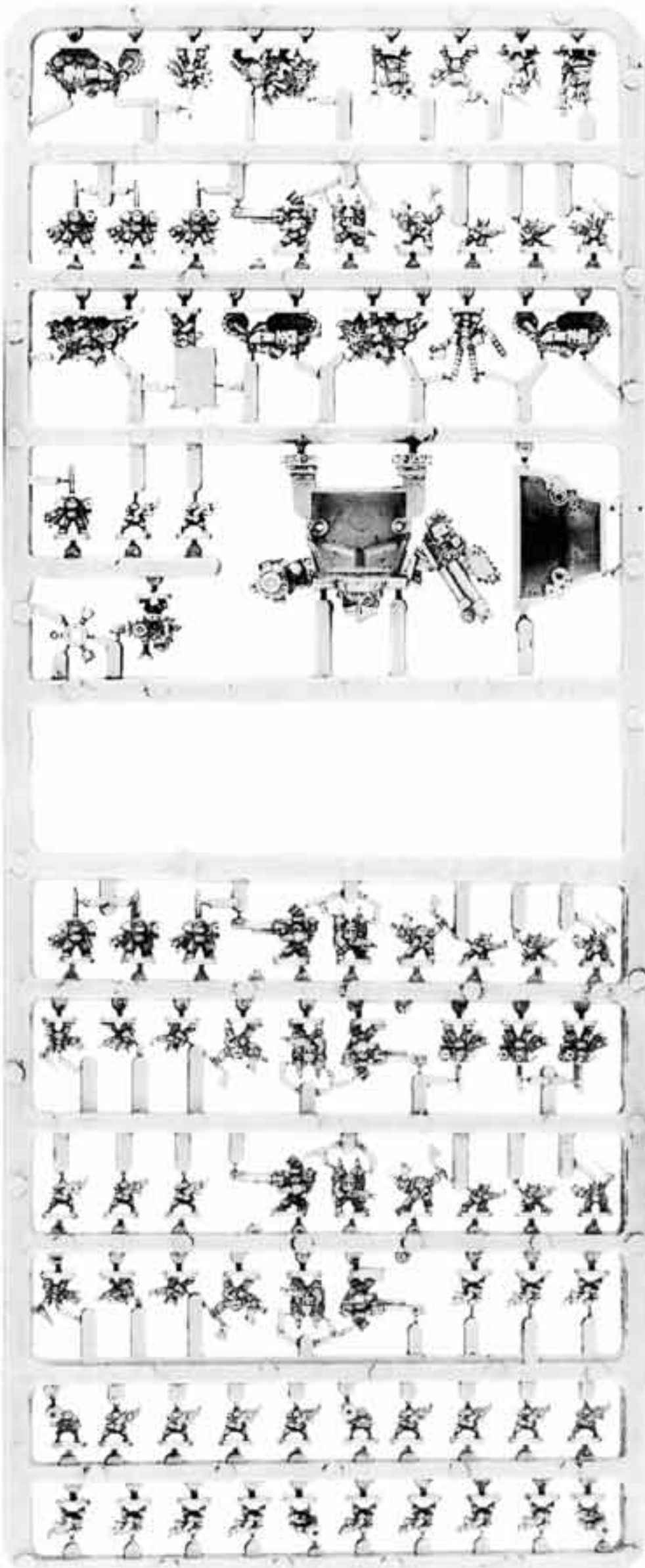

ORK MOB SPRUE (SHOWN AT 80% OF ACTUAL SIZE)
99389999038

ORK MOB SPRUE CONTENTS:

1 x STOMPER, 3 x WARBIKES, 15 x GRETCHIN, 11 x NOBZ, 5 x SHOOTY BOYZ,
5 x STORMBOYZ, 1 x SHOKK ATTACK GUN, 5 x KOMMANDOS, 28 x BOYZ, 1 x WARBOSS,
1 x BATTLE STANDARD, 1 x MEKANIAK, 1 x PAINBOY, 1 x WEIRDBOY, 1 x RUNTHERD

ORK BATTLEWAGONS SPRUE

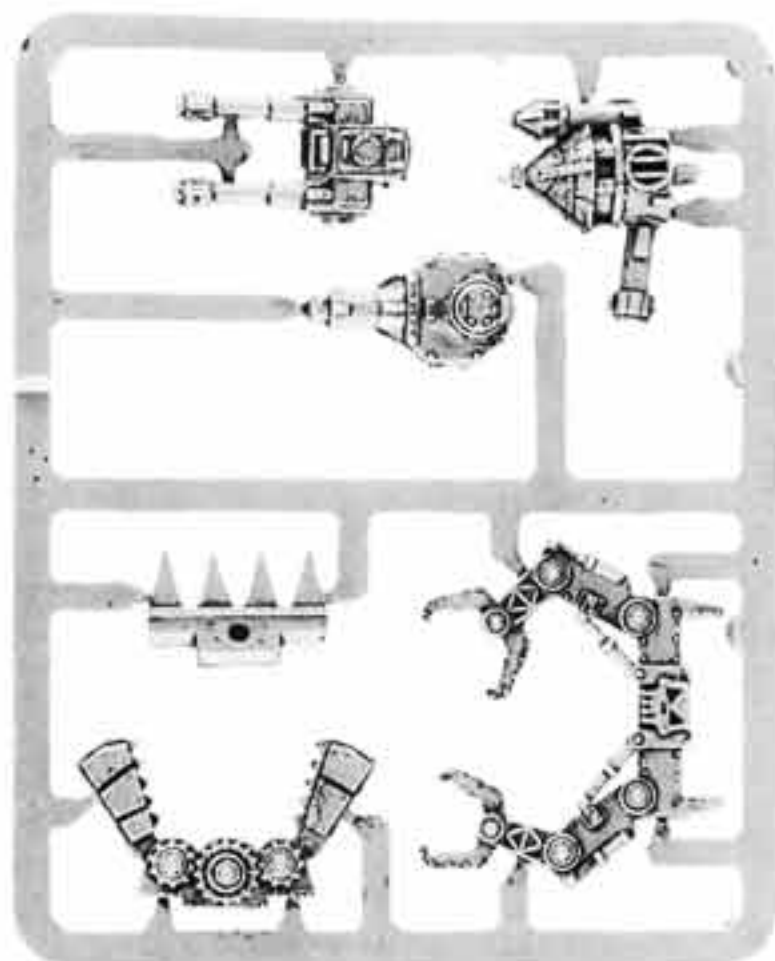

ORK TURRET SPRUE 1
99399999013

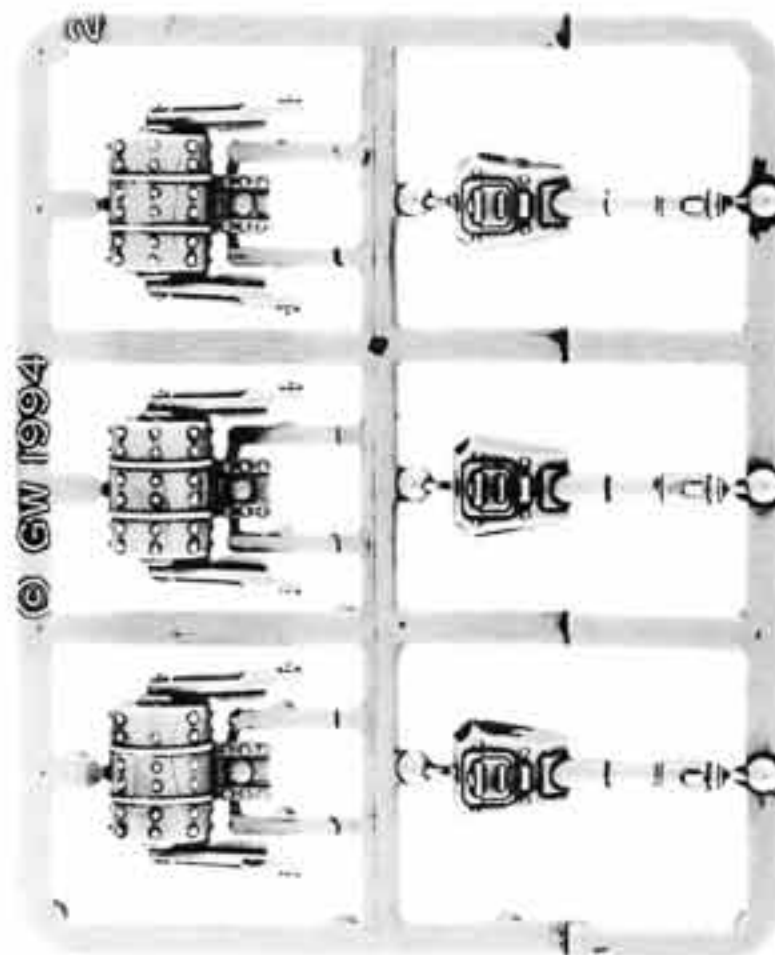

© GW 1994

ORK TURRET SPRUE 2
99399999013

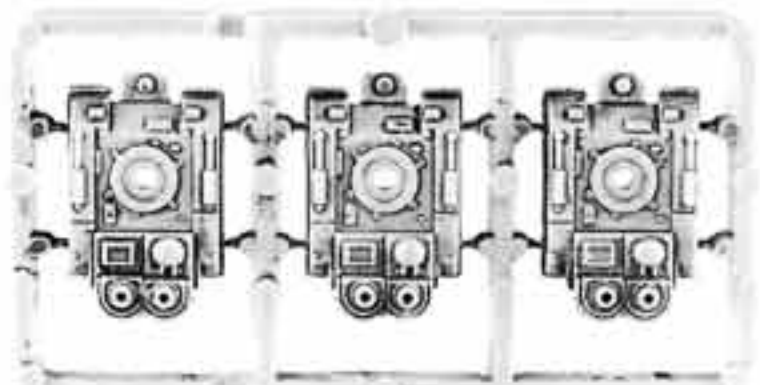

ORK TANK CHASIS SPRUE (SHOWN AT 80% OF ACTUAL SIZE)
99399999012



CITADEL
MINIATURES



CITADEL
MINIATURES

EPIC® 40,000

ORK WEIRDBOY BATTLE TOWER

ORK BATTLE TOWER TRACKS 1
030301402



RIGHT TRACK



LEFT TRACK

ORK BATTLE TOWER TRACKS 2
030301406

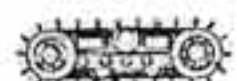

RIGHT TRACK



LEFT TRACK

ORK BATTLE TOWER TRACKS 3
030301407



RIGHT TRACK



LEFT TRACK

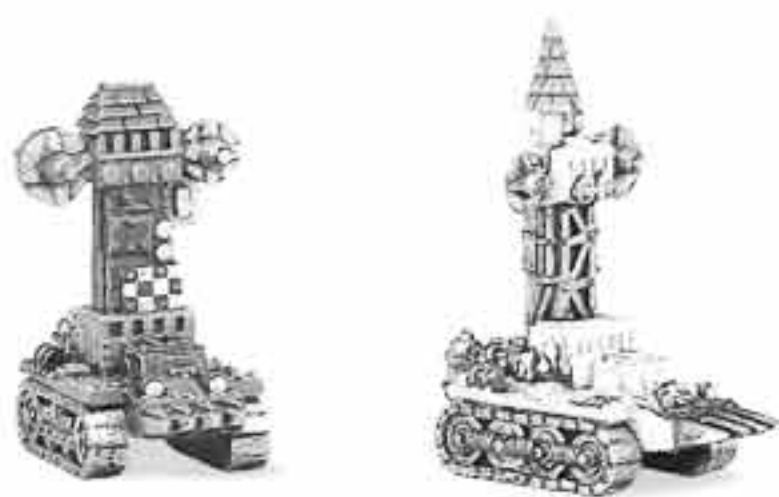

ORK WEIRDBOY BATTLE TOWERS



ORK BATTLE TOWER 1
030301403



ORK BATTLE TOWER 2
030301408



ORK BATTLE TOWER 3
030301409

A COMPLETE ORK WEIRDBOY BATTLE TOWER CONSISTS OF:
1 x ORK BATTLE TOWER HULL
1 x SET OF ORK BATTLE TOWER TRACKS
1 x ORK BATTLE TOWER

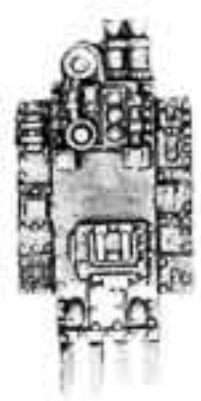

ORK BATTLE TOWER HULL 1
030301401



ORK BATTLE TOWER HULL 2
030301404



ORK BATTLE TOWER HULL 3
030301405

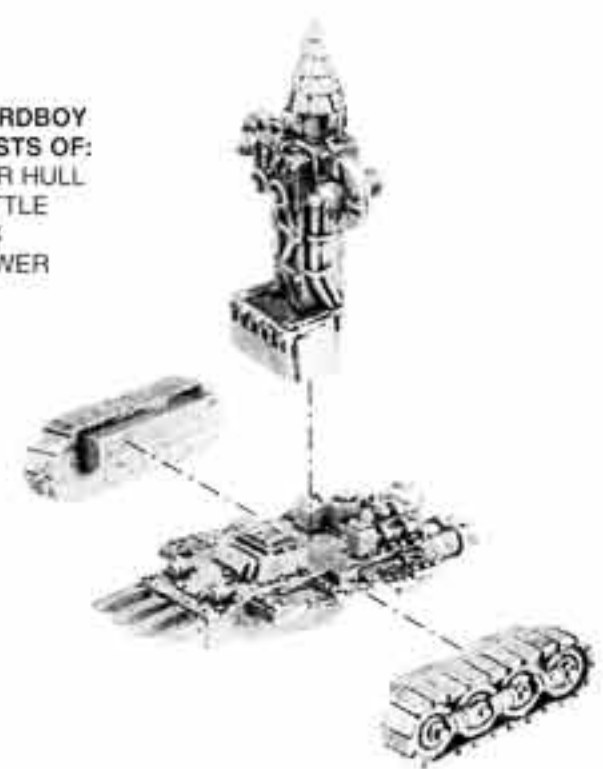

ORK SQUIGGOTH

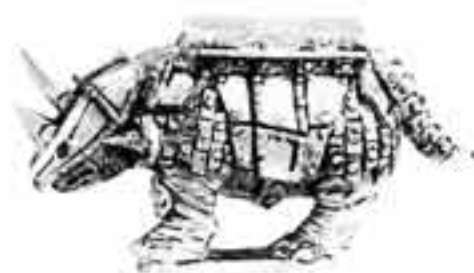

ORK SQUIGGOTH 1 LEFT SIDE
030301101



ORK SQUIGGOTH 1 RIGHT SIDE
030301102



ORK SQUIGGOTH



ORK SQUIGGOTH 2 RIGHT SIDE
030301103



ORK SQUIGGOTH 2 LEFT SIDE
030301104

A COMPLETE ORK SQUIGGOTH CONSISTS OF:
1 x ORK SQUIGGOTH LEFT SIDE
1 x ORK SQUIGGOTH RIGHT SIDE
1 x ORK SQUIGGOTH TURRET



ORK SQUIGGOTH TURRET 1
030301105



ORK SQUIGGOTH TURRET 2
030301106



Weirdboy Battle Towers designed by Norman Swales, Squiggoths designed by Dave Andrews

Not suitable for children under 8 years due to small parts and essential pointed components. All models supplied unpainted.

© Copyright Games Workshop Ltd. 1998. All rights reserved.

EPIC® 40,000

ORK GARGANT

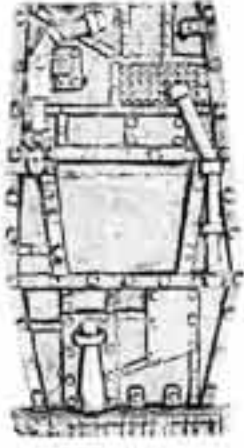

GARGANT FRONT PLATE
030300404

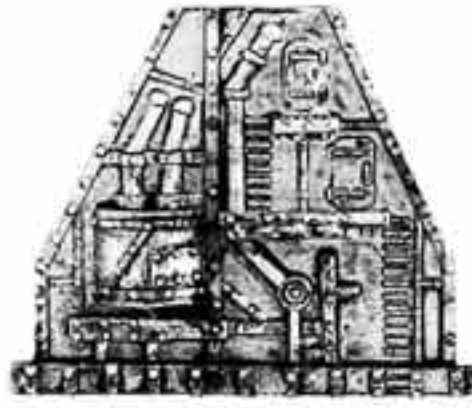

GARGANT BACK PLATE
030300401



GARGANT LEFT PLATE
030300402

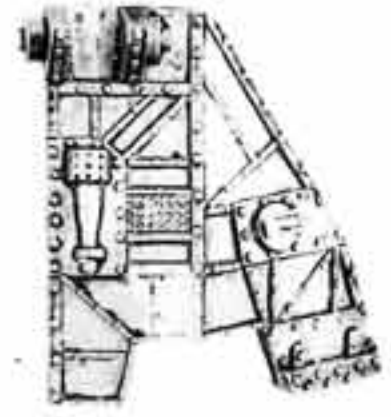

GARGANT RIGHT PLATE
030300403



GARGANT BELLY
MEGA CANNON
030300409

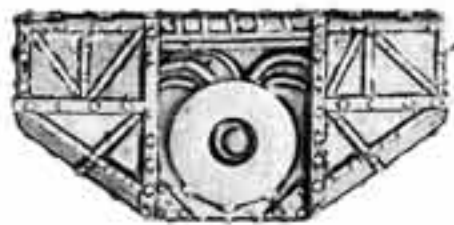

GARGANT SHOULDER
030300405

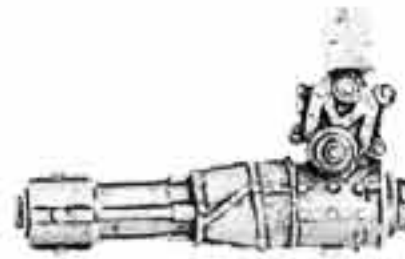

GARGANT LEFT ARM
MEGA CANNON
030300411

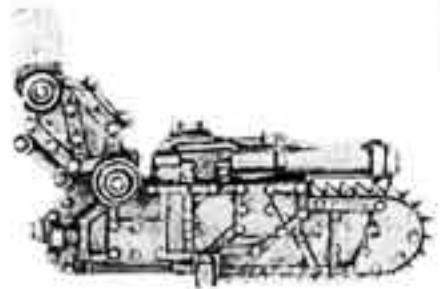

GARGANT RIGHT ARM
CLOSE COMBAT WEAPON
030300412



GARGANT HEAD
030300408



GARGANT ANKLE
030300410

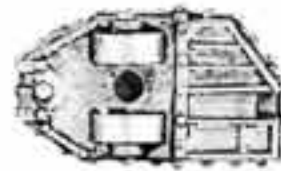

GARGANT LEFT FOOT
030300407

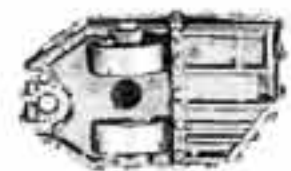

GARGANT RIGHT FOOT
030300406



- A COMPLETED ORK GARGANT CONSISTS OF:**
- 1 x GARGANT FRONT PLATE
 - 1 x GARGANT BACK PLATE
 - 1 x GARGANT LEFT PLATE
 - 1 x GARGANT RIGHT PLATE
 - 1 x GARGANT BELLY MEGA CANNON
 - 1 x GARGANT SHOULDER
 - 1 x GARGANT LEFT ARM MEGA CANNON
 - 1 x GARGANT RIGHT ARM CLOSE COMBAT WEAPON
 - 1 x GARGANT HEAD
 - 2 x GARGANT ANKLES
 - 1 x GARGANT LEFT FOOT
 - 1 x GARGANT RIGHT FOOT



ORK GARGANT



Designed by Dave Andrews

Not suitable for children under 8 years due to small parts and essential pointed components. All models supplied unpainted.
© Copyright Games Workshop Ltd. 1998. All rights reserved.

EPIC® 40,000

ORK GREAT GARGANT

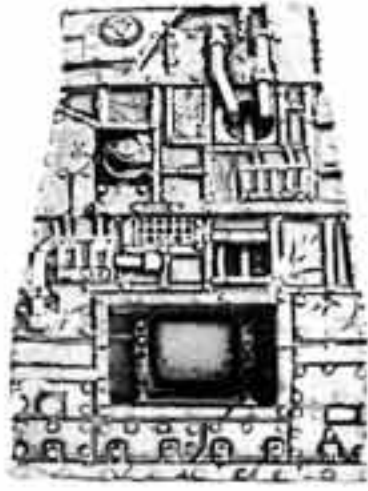

FRONT
030300309

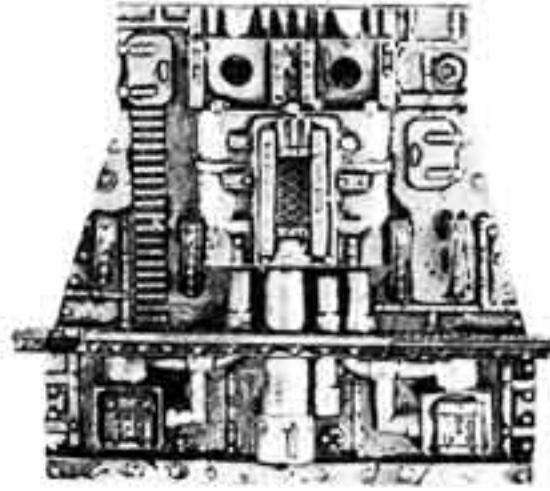

BACK
030300303

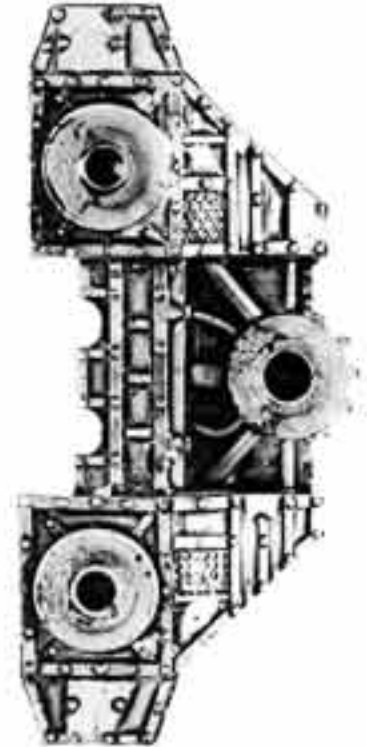

SHOULDERS
030300302

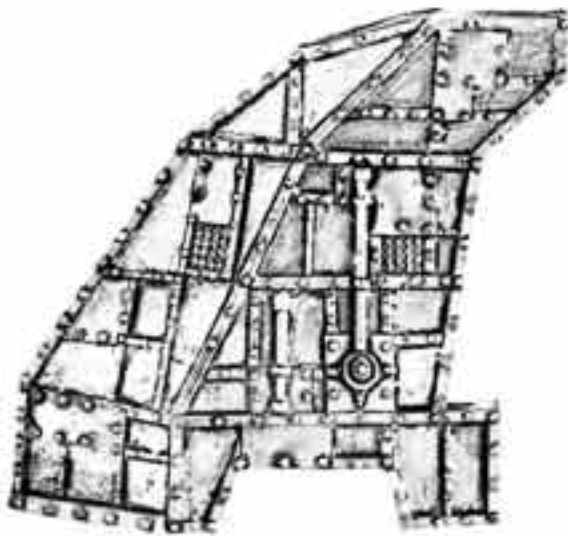

LEFT SIDE
030300307

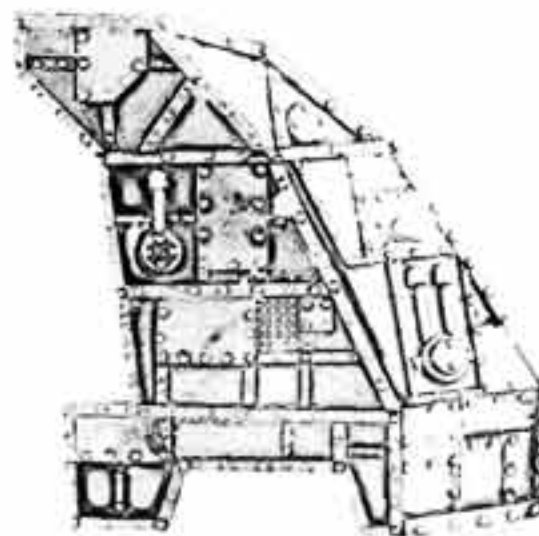

RIGHT SIDE
030300308



HEAD
030300301

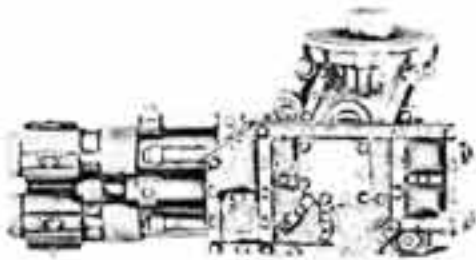

HEAVY WEAPON BATTERY
030300312

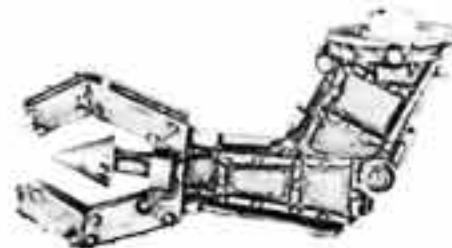

SUPER LIFTA DROPPA
030300313



JAW
030300306



TURRET 2
030300314



TURRET 1
030300315



CANNON
030300318

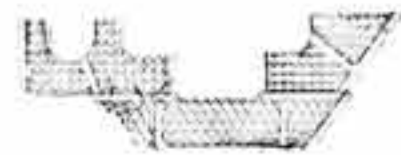

BACK WALKWAY
030300304



RIGHT FOOT
030300310

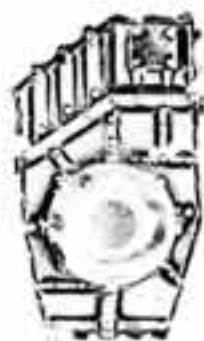

LEFT FOOT
030300311



ANKLE
030300305



EXHAUST 1
030300316



EXHAUST 2
030300317



Designed by Dave Andrews

EPIC® 40,000

ORK GREAT GARGANT

THE COMPLETE GREAT GARGANT CONSISTS OF:

- 1 x FRONT
- 1 x BACK
- 1 x LEFT SIDE
- 1 x RIGHT SIDE
- 1 x SHOULDERS
- 1 x HEAD
- 1 x JAW
- 1 x TURRET 1
- 1 x TURRET 2
- 1 x HEAVY WEAPON BATTERY
- 1 x SUPER LIFTA DROPPA
- 1 x BACK WALKWAY
- 1 x EXHAUST 1
- 1 x EXHAUST 2
- 1 x CANNON
- 2 x ANKLES
- 1 x LEFT FOOT
- 1 x RIGHT FOOT

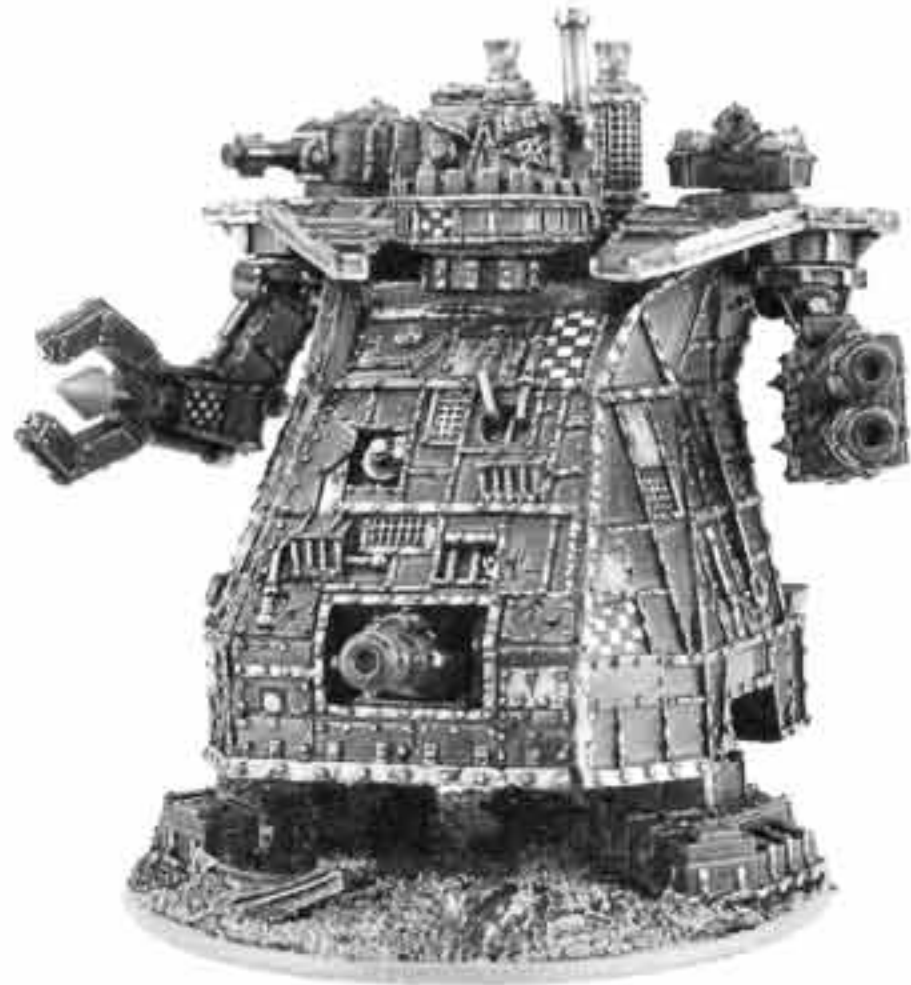

GREAT GARGANT

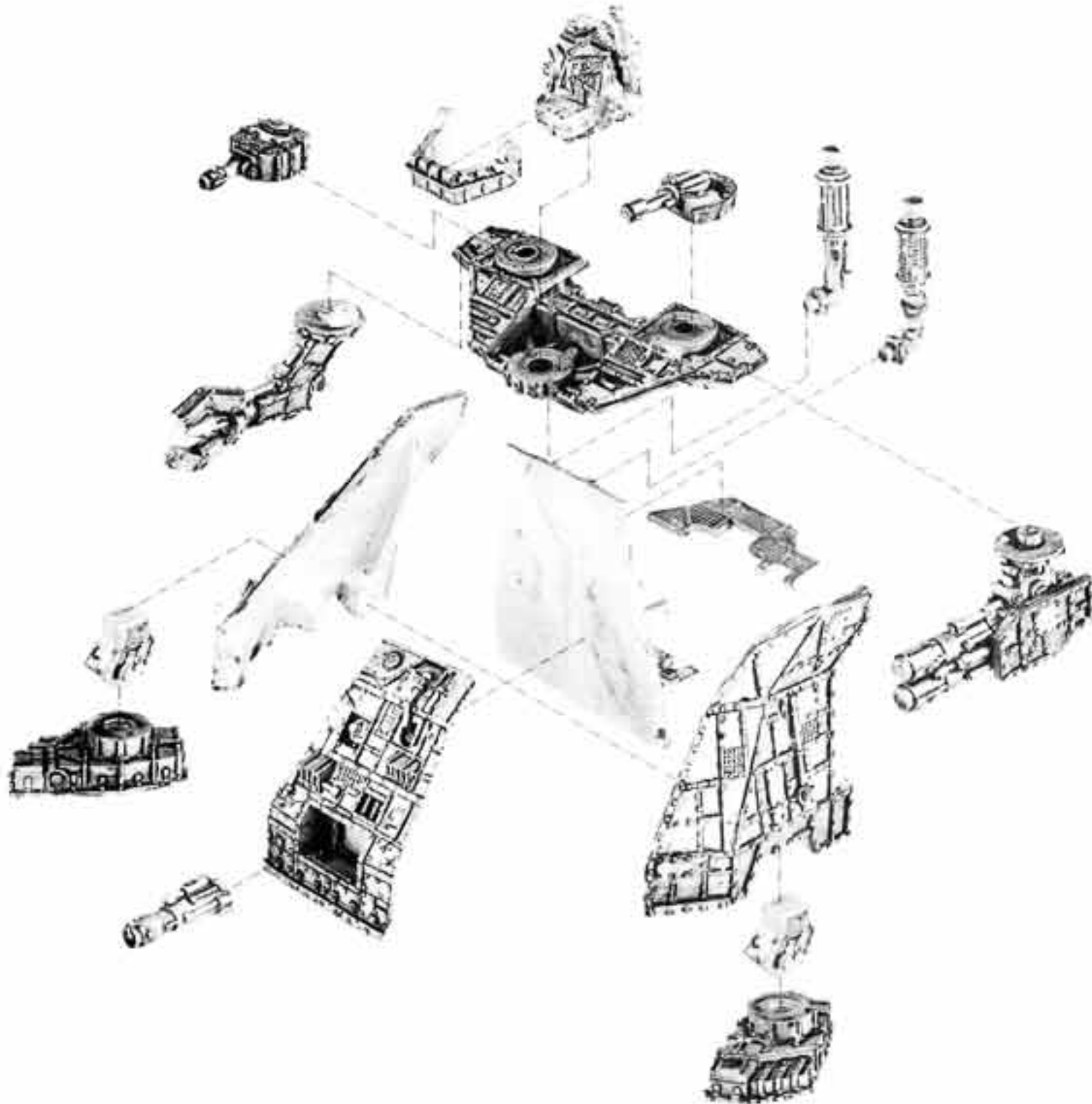

Designed by Dave Andrews

Not suitable for children under 36 months due to small parts and essential pointed components. All models supplied unpainted.
© Copyright Games Workshop Ltd., 1997. All rights reserved.

EPIC® 40,000

ORK WAR BUGGIES



AUTO CANNON
030300104



HEAVY FLAMER
030300106

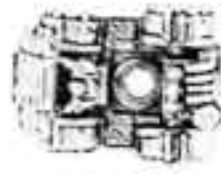

HULL 1
030300101

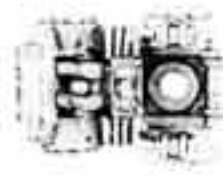

HULL 2
030300102

**A COMPLETED WAR BUGGY
CONSISTS OF:**
1 x HULL
1 x WEAPON



HEAVY BOLTER
030300105



MULTI-MELTA
030300107

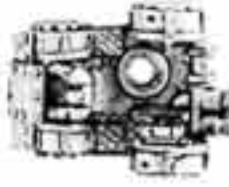

HULL 3
030300103



ORK WAR BUGGIES

ORK BIG GUNZ

SMASHA GUN
030300205



SMASHA GUN TOP



**SMASHA GUN
SUPPORT**



SPLATTA KANNON
030300203

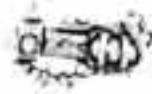

TRAKTOR KANNON
030300204



BIG GUN CHASSIS 1
030300201



BIG GUN CHASSIS 2
030300202

**A COMPLETED TRAKTOR
KANNON CONSISTS OF:**
1 x TRAKTOR KANNON
1 x BIG GUN CHASSIS

**A COMPLETED SPLATTA
KANNON CONSISTS OF:**
1 x SPLATTA KANNON
1 x BIG GUN CHASSIS

**A COMPLETED SMASHA GUN
CONSISTS OF:**
1 x SMASHA GUN TOP
1 x SMASHA GUN SUPPORT
1 x BIG GUN CHASSIS



ORK BIG GUNZ

Designed by Norman Swales



WARHAMMER®



BRETONNIA

BRETONNIAN BOWMEN



PLASTIC BRETONNIAN BOWMEN



BRETONNIAN BOWMEN SPRUE
99389999069

BRETONNIAN HORSES

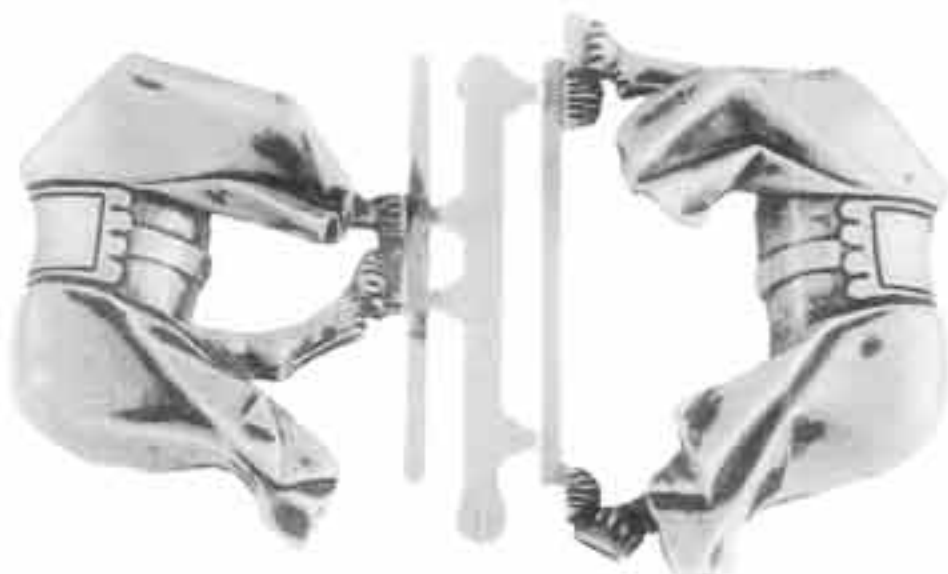

BRETONNIAN HORSE BODY SPRUE 1
99389999004



BRETONNIAN HORSE
HEAD SPRUE 1
99389999014

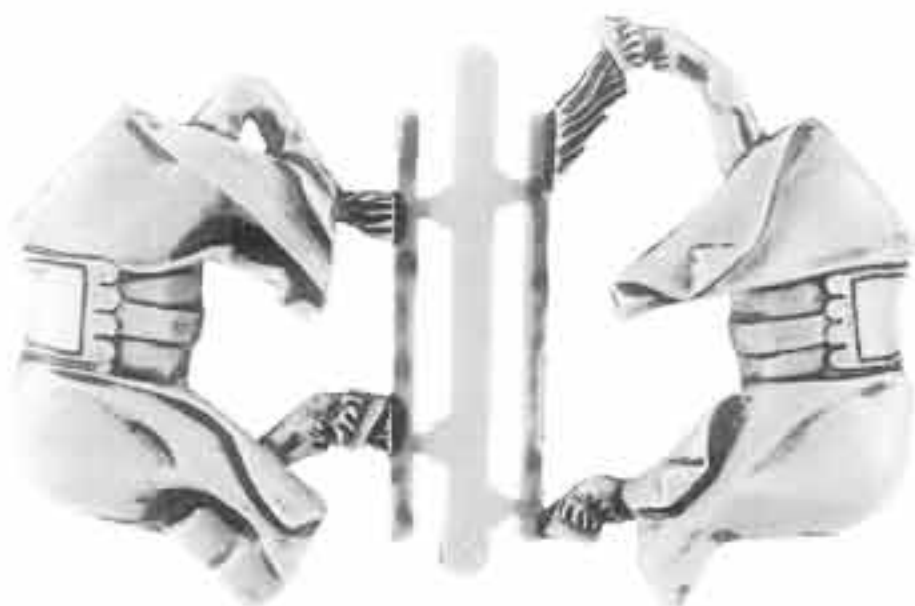

BRETONNIAN HORSE BODY SPRUE 2
99389999004



BRETONNIAN HORSE
HEAD SPRUE 2
99389999014

BRETONNIA

KNIGHTS OF THE REALM

A COMPLETE KNIGHT OF THE REALM CONSISTS OF:
1 x PLASTIC KNIGHT OF THE REALM SPRUE
1 x BRETONNIAN HORSE



PLASTIC KNIGHTS OF THE REALM

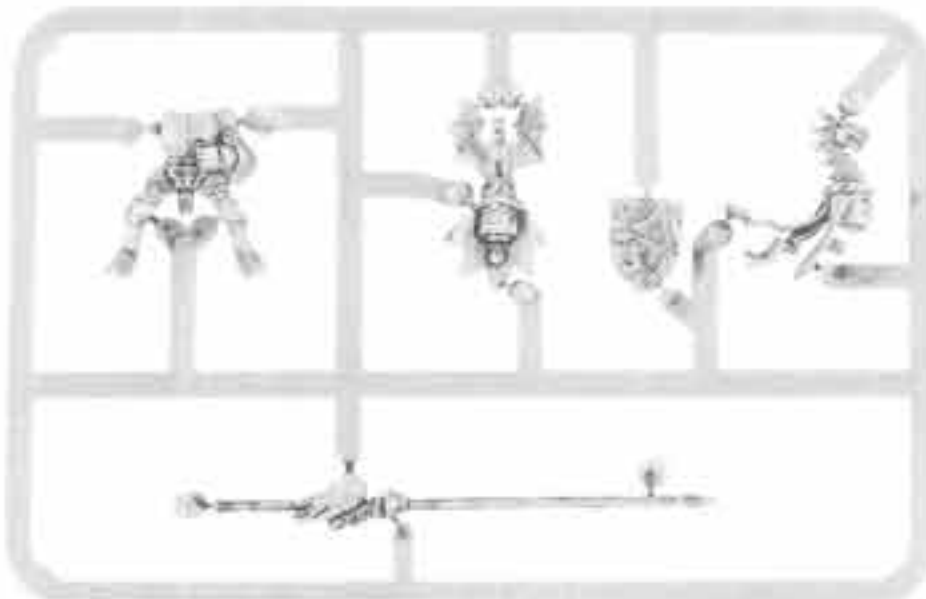

PLASTIC KNIGHT OF THE REALM SPRUE 1
993899070

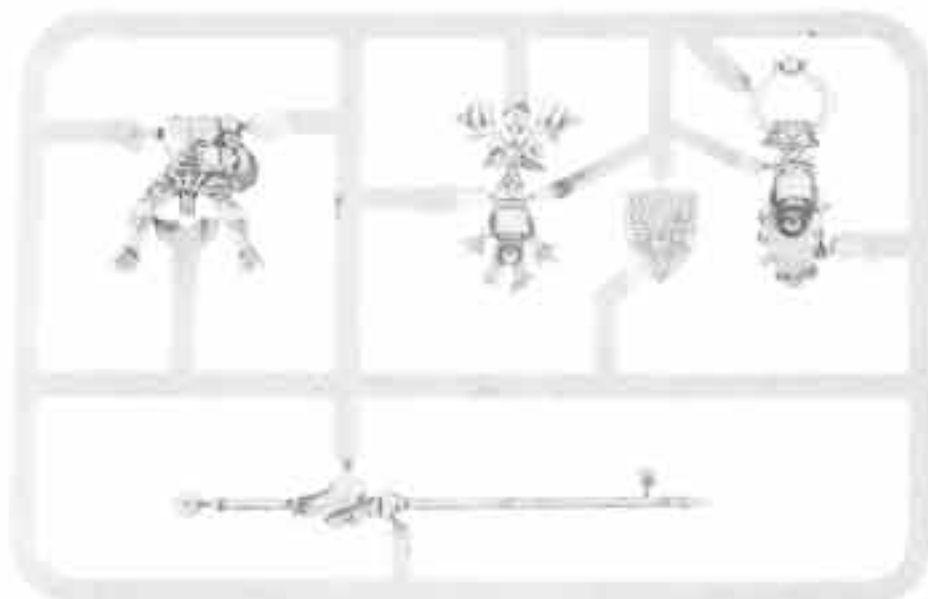

PLASTIC KNIGHT OF THE REALM SPRUE 2
993899070

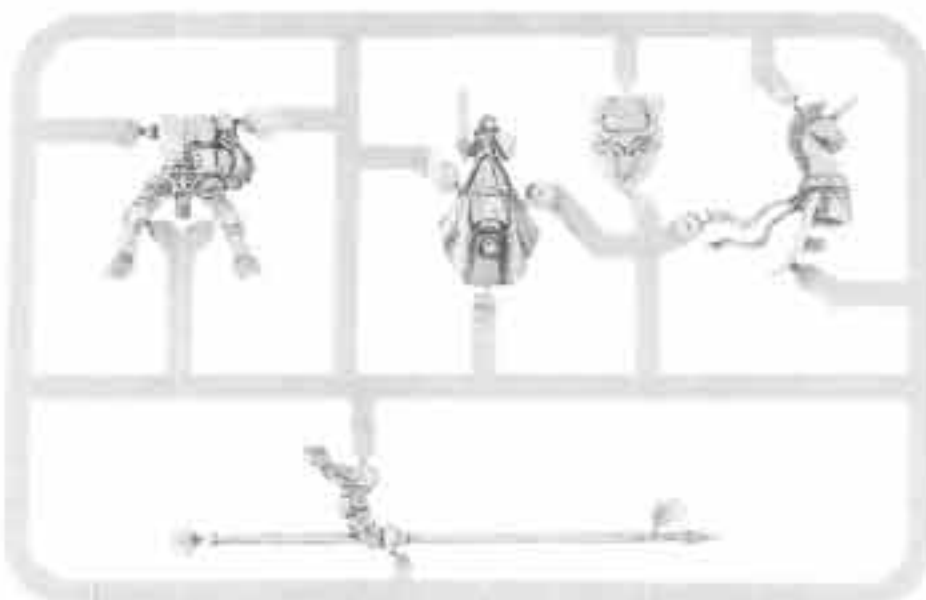

PLASTIC KNIGHT OF THE REALM SPRUE 3
993899070

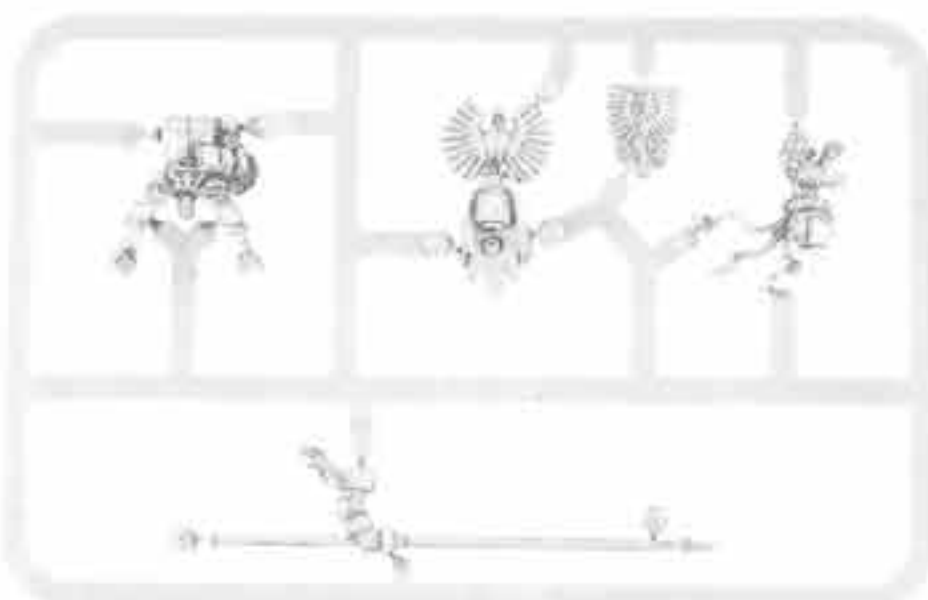

PLASTIC KNIGHT OF THE REALM SPRUE 4
993899070

SPRUES SHOW AT 40% OF NORMAL SIZE



BRETONNIA

KNIGHTS OF THE REALM



KNIGHT OF THE REALM BODY 1
020300504



KNIGHT OF THE REALM BODY 2
020300505



KNIGHT OF THE REALM BODY 3
020300506

A COMPLETE KNIGHT OF THE REALM CONSISTS OF:
1 x KNIGHT OF THE REALM BODY
1 x KNIGHT OF THE REALM LANCE
1 x KNIGHT OF THE REALM LEGS
1 x BRETONNIAN HORSE
1 x FIGHTER SHIELD SPRUE



KNIGHT OF THE REALM LANCE 1
020300502



KNIGHT OF THE REALM LANCE 2
020300503



KNIGHT OF THE REALM LEGS
020300501



BRETONNIAN KNIGHT OF THE REALM

MEN-AT-ARMS HALBERDIER



CHAMPION
020301901



DRUMMER
020301803



STANDARD BEARER
020301802

MEN-AT-ARMS ARE SUPPLIED WITH FIGHTER SHIELDS



FIGHTER SHIELD SPRUE
101637



HALBERDIER 1
020301701



HALBERDIER 2
020301702



HALBERDIER 3
020301703



BRETONNIA

KNIGHTS OF THE REALM COMMAND GROUP



KNIGHT OF THE REALM
STANDARD BEARER BODY
020301102



KNIGHT OF THE REALM
CHAMPION BODY
020301202



KNIGHT OF THE REALM
STANDARD TOP
020301103



KNIGHT OF THE REALM
TRUMPETER BODY
020301302



KNIGHT OF THE REALM
LEGS 1
020300501



KNIGHT OF THE REALM
LEGS 2
020302501

A COMPLETED BRETONNIAN KNIGHT OF THE REALM TRUMPETER CONSISTS OF:
1 x KNIGHT OF THE REALM TRUMPETER BODY
1 x KNIGHT OF THE REALM LEGS 2
1 x BRETONNIAN HORSE SPRUE
1 x FIGHTER SHIELD SPRUE

A COMPLETED BRETONNIAN KNIGHT OF THE REALM CHAMPION CONSISTS OF:
1 x KNIGHT OF THE REALM CHAMPION BODY
1 x KNIGHT OF THE REALM LEGS 2
1 x BRETONNIAN HORSE SPRUE
1 x FIGHTER SHIELD SPRUE

A COMPLETED BRETONNIAN KNIGHT OF THE REALM STANDARD BEARER CONSISTS OF:
1 x KNIGHT OF THE REALM STANDARD BEARER BODY
1 x KNIGHT OF THE REALM STANDARD TOP
1 x KNIGHT OF THE REALM LEGS 1
1 x BRETONNIAN HORSE SPRUE
1 x FIGHTER SHIELD SPRUE



A KNIGHT OF THE REALM TRUMPETER



A KNIGHT OF THE REALM CHAMPION



A KNIGHT OF THE REALM STANDARD BEARER



Designed by Alan Perry

Not suitable for children under 8 years due to small parts and essential pointed components. All models supplied unpainted.
© Copyright Games Workshop Ltd. 1998. All rights reserved.

BRETONNIA

KNIGHTS ERRANT COMMAND GROUP



KNIGHT ERRANT
CHAMPION BODY
020302502

KNIGHT OF THE REALM
LEGS 2
020302501



KNIGHT ERRANT STANDARD
BEARER BODY
020300402



STANDARD TOP
020300403



KNIGHT ERRANT
TRUMPETER BODY
020300302



BRETONNIAN
KNIGHT ERRANT CHAMPION

A COMPLETED KNIGHT ERRANT
CHAMPION CONSISTS OF:
1 x KNIGHT ERRANT CHAMPION BODY
1 x KNIGHT OF THE REALM LEGS 2 OR
KNIGHT ERRANT LEGS
1 x BRETONNIAN HORSE
1 x FIGHTERS SHIELD SPRUE

A COMPLETED KNIGHT ERRANT
STANDARD BEARER CONSISTS OF:
1 x KNIGHT ERRANT
STANDARD BEARER BODY
1 x STANDARD TOP
1 x KNIGHT OF THE REALM LEGS 2
OR KNIGHT ERRANT LEGS
1 x BRETONNIAN HORSE
1 x FIGHTERS SHIELD SPRUE

A COMPLETED KNIGHT ERRANT
TRUMPETER CONSISTS OF:
1 x KNIGHT ERRANT
TRUMPETER BODY
1 x KNIGHT OF THE REALM LEGS 2
OR KNIGHT ERRANT LEGS
1 x BRETONNIAN HORSE
1 x FIGHTERS SHIELD SPRUE

KNIGHTS ERRANT



KNIGHT ERRANT BODY 1
020302404



KNIGHT ERRANT BODY 2
020302405



KNIGHT ERRANT BODY 3
020302406



KNIGHT ERRANT LEGS
020302401



KNIGHT ERRANT LANCE 1
020302402



KNIGHT ERRANT LANCE 2
020302403



BRETONNIAN KNIGHT ERRANT

A COMPLETED KNIGHT ERRANT
CONSISTS OF:
1 x KNIGHT ERRANT BODY
1 x KNIGHT ERRANT LEGS
1 x KNIGHT ERRANT LANCE
1 x BRETONNIAN HORSE
1 x FIGHTERS SHIELD SPRUE

BRETONNIA™

QUESTING KNIGHTS



QUESTING KNIGHT
BODY 1
020303901



QUESTING KNIGHT
BODY 2
020303902



QUESTING KNIGHT
BODY 3
020303903



QUESTING KNIGHT
BODY 4
020303904



QUESTING KNIGHT
BODY 5
020305505



QUESTING KNIGHT
BODY 6
020305506



QUESTING KNIGHT
BODY 7
020305507



QUESTING KNIGHT
BODY 8
020305508



QUESTING KNIGHT
BODY 9
020305509



QUESTING KNIGHT
BODY 10
020305510



QUESTING KNIGHT
BODY 11
020305511



QUESTING KNIGHT
BODY 12
020305512



QUESTING KNIGHT
BODY 13
020305513



QUESTING KNIGHT
BODY 14
020305514



QUESTING KNIGHT
BODY 15
020305515



QUESTING KNIGHT
BODY 16
020305516



QUESTING KNIGHT
BODY 17
020305517



QUESTING KNIGHT
BODY 18
020305518



QUESTING KNIGHT
BODY 19
020305519



QUESTING KNIGHT
BODY 20
020305520



GRAIL KNIGHT LANCE 1
020302703



GRAIL KNIGHT LANCE 2
020302702



KNIGHT OF THE REALM LEGS
020300501



QUESTING KNIGHT HORSE HEAD 1
020303905



QUESTING KNIGHT HORSE HEAD 2
020303906



QUESTING KNIGHT HORSE HEAD 3
020303907

A COMPLETE QUESTING KNIGHT CONSISTS OF:
1 x QUESTING KNIGHT BODY
1 x QUESTING KNIGHT HORSE HEAD
1 x KNIGHT OF THE REALM LEGS
1 x GRAIL KNIGHT LANCE
1 x BRETONNIAN HORSE
1 x PLASTIC FIGHTER SHIELD SPRUE



Designed by Alan Perry

Not suitable for children under 36 months due to small parts and essential pointed components. All models supplied unpainted.
© Copyright Games Workshop Ltd., 1997. All rights reserved.

BRETONNIA™

QUESTING KNIGHT COMMAND



QUESTING KNIGHT
CHAMPION BODY
020304902



QUESTING KNIGHT
STANDARD BEARER BODY
020305002



QUESTING KNIGHT
TRUMPETER BODY
020305102



QUESTING KNIGHT
HORSE HEAD 1
020303905



QUESTING KNIGHT
HORSE HEAD 2
020303906



QUESTING KNIGHT
HORSE HEAD 3
020303907



QUESTING KNIGHT
CHAMPION'S LANCE
020304903



QUESTING KNIGHT
STANDARD BEARER ARM
020305003

A COMPLETE QUESTING KNIGHT CHAMPION CONSISTS OF:

- 1 x QUESTING KNIGHT
CHAMPION BODY
- 1 x QUESTING KNIGHT
CHAMPION'S LANCE
- 1 x QUESTING KNIGHT
HORSE HEAD
- 1 x KNIGHT OF THE REALM LEGS
- 1 x BRETONNIAN HORSE
- 1 x PLASTIC FIGHTER
SHIELD SPRUE

A COMPLETE QUESTING KNIGHT STANDARD BEARER CONSISTS OF:

- 1 x QUESTING KNIGHT
STANDARD BEARER BODY
- 1 x QUESTING KNIGHT
STANDARD BEARER ARM
- 1 x QUESTING KNIGHT
HORSE HEAD
- 1 x KNIGHT OF THE REALM LEGS
- 1 x BRETONNIAN HORSE
- 1 x PLASTIC FIGHTER
SHIELD SPRUE

A COMPLETE QUESTING KNIGHT TRUMPETER CONSISTS OF:

- 1 x QUESTING KNIGHT
TRUMPETER BODY
- 1 x QUESTING KNIGHT
HORSE HEAD
- 1 x KNIGHT OF THE REALM LEGS
- 1 x BRETONNIAN HORSE
- 1 x PLASTIC FIGHTER
SHIELD SPRUE



KNIGHT OF THE REALM LEGS
020300501



QUESTING KNIGHT CHAMPION



QUESTING KNIGHT TRUMPETER



QUESTING KNIGHT STANDARD BEARER

BRETONNIA™

GRAIL KNIGHTS



GRAIL KNIGHT



GRAIL KNIGHT LANCE 1
020302702



GRAIL KNIGHT LANCE 2
020302703



GRAIL KNIGHT LEGS
020302701

A COMPLETED GRAIL KNIGHT
CONSISTS OF:
1 x GRAIL KNIGHT BODY
1 x GRAIL KNIGHT LEGS
1 x GRAIL KNIGHT HORSE HEAD
1 x GRAIL KNIGHT LANCE
1 x GRAIL KNIGHT SHIELD
1 x BRETONNIAN HORSE SPRUE

GRAIL KNIGHTS BODY'S, SHIELDS AND HORSE HEADS ARE NOT INTERCHANGEABLE

GRAIL KNIGHT 1



GRAIL KNIGHT BODY 1
020302704



GRAIL KNIGHT
SHIELD 1
020302705



GRAIL KNIGHT
HORSE HEAD 1
020302706

GRAIL KNIGHT 2



GRAIL KNIGHT BODY 2
020302707



GRAIL KNIGHT
SHIELD 2
020302708



GRAIL KNIGHT
HORSE HEAD 2
020302709

GRAIL KNIGHT 3



GRAIL KNIGHT BODY 3
020302710



GRAIL KNIGHT
SHIELD 3
020302711



GRAIL KNIGHT
HORSE HEAD 3
020302712

Designed by Michael Perry

Not suitable for children under 8 years due to small parts and essential pointed components. All models supplied unpainted.
© Copyright Games Workshop Ltd. 1998. All rights reserved.

BRETONNIA

GRAIL KNIGHT COMMAND

GRAIL KNIGHT
STANDARD BEARER



STANDARD BEARER
020302202



STANDARD BEARER'S SHIELD
020302205



STANDARD BEARER'S
HORSE HEAD
020302204



STANDARD TOP
020302203

GRAIL KNIGHT
CHAMPION



CHAMPION
020302002



CHAMPION'S SHIELD
020302004



CHAMPION'S HORSE HEAD
020302003

GRAIL KNIGHT
TRUMPETER



TRUMPETER
020302102



TRUMPETER'S SHIELD
020302104



TRUMPETER'S HORSE HEAD
020302103



GRAIL KNIGHT LEGS
WITH LANCE
020302001



GRAIL KNIGHT LEGS
020302701

BODIES, SHIELDS AND HORSE HEADS ARE NOT INTERCHANGEABLE

A COMPLETED GRAIL KNIGHT
CHAMPION CONSISTS OF:
1 x CHAMPION

- 1 x GRAIL KNIGHT LEGS WITH LANCE
- 1 x CHAMPION'S HORSE HEAD
- 1 x CHAMPION'S SHIELD
- 1 x BRETONNIAN HORSE SPRUE

A COMPLETED GRAIL KNIGHT
TRUMPETER CONSISTS OF:
1 x TRUMPETER

- 1 x GRAIL KNIGHT LEGS WITH LANCE
- 1 x TRUMPETER'S HORSE HEAD
- 1 x TRUMPETER'S SHIELD
- 1 x BRETONNIAN HORSE SPRUE

A COMPLETED GRAIL KNIGHT
STANDARD BEARER CONSISTS OF:

- 1 x STANDARD BEARER
- 1 x GRAIL KNIGHT LEGS
- 1 x STANDARD BEARER'S HORSE HEAD
- 1 x STANDARD BEARER'S SHIELD
- 1 x STANDARD TOP
- 1 x BRETONNIAN HORSE SPRUE



GRAIL KNIGHT CHAMPION



CITADEL
MINIATURES



CITADEL
MINIATURES

BRETONNIA™

GRAIL KNIGHT HERO WITH TWO - HANDED SWORD



GRAIL KNIGHT HERO WITH TWO HANDED SWORD



GRAIL KNIGHT HERO BODY
020304702



GRAIL KNIGHT LEGS
020302701



GRAIL KNIGHT HERO SWORD ARM
020304703



GRAIL KNIGHT HERO HORSE HEAD
020304704

A COMPLETE GRAIL KNIGHT HERO WITH TWO - HANDED SWORD CONSISTS OF:
1 x GRAIL KNIGHT HERO BODY
1 x GRAIL KNIGHT HERO SWORD ARM
1 x GRAIL KNIGHT HERO HORSE HEAD
1 x BRETONNIAN HORSE
1 x GRAIL KNIGHT LEGS

QUESTING KNIGHT HERO WITH LANCE



QUESTING KNIGHT HERO WITH LANCE

A COMPLETE QUESTING KNIGHT HERO WITH LANCE CONSISTS OF:
1 x QUESTING KNIGHT HERO BODY
1 x QUESTING KNIGHT HERO LANCE ARM
1 x QUESTING KNIGHT HERO HORSE HEAD
1 x BRETONNIAN HORSE
1 x QUESTING KNIGHT HERO SHIELD
1 x KNIGHT OF THE REALM LEGS



QUESTING KNIGHT HERO BODY
020304602



KNIGHT OF THE REALM LEGS
020300501



QUESTING KNIGHT HERO HORSE HEAD
020304605



QUESTING KNIGHT HERO SHIELD
020304604



QUESTING KNIGHT HERO LANCE ARM
020304603

KNIGHT OF THE REALM HERO



KNIGHT OF THE REALM HERO WITH MORNING STAR



KNIGHT OF THE REALM HERO BODY
020304802



KNIGHT OF THE REALM LEGS
020300501



KNIGHT OF THE REALM HERO HORSE HEAD
020304804



KNIGHT OF THE REALM HERO SHIELD
020304803

A COMPLETE KNIGHT OF THE REALM HERO WITH MORNING STAR CONSISTS OF:
1 x KNIGHT OF THE REALM HERO BODY
1 x KNIGHT OF THE REALM HERO HORSE HEAD
1 x BRETONNIAN HORSE
1 x KNIGHT OF THE REALM HERO SHIELD
1 x KNIGHT OF THE REALM HERO LEGS

BRETONNIA™

MEN AT ARMS WITH SPEARS



MEN AT ARMS WITH
SPEAR CHAMPION 1
020301001



MEN AT ARMS WITH
SPEAR CHAMPION 2
020301002



MEN AT ARMS WITH SPEAR
STANDARD BEARER 1
020300903



MEN AT ARMS WITH SPEAR
STANDARD BEARER 2
020300904



MEN AT ARMS
TRUMPETER 1
020300905



MEN AT ARMS
TRUMPETER 2
020300906



MEN AT ARMS WITH
SPEAR 1
020300801



MEN AT ARMS WITH
SPEAR 2
020300802



MEN AT ARMS WITH
SPEAR 3
020300803



MEN AT ARMS WITH
SPEAR 4
020300804

THESE MODELS ARE SUPPLIED WITH A FIGHTER
SHIELD SPRUE WHERE APPROPRIATE



MEN AT ARMS WITH SPEARS



FIGHTER SHIELD SPRUE
101635

BRETONNIA

BOWMEN



CHAMPION 1
020301601



CHAMPION 2
020301602



STANDARD
BEARER 1
020301504



STANDARD
BEARER 2
020301503



TRUMPETER 1
020301505



TRUMPETER 2
020301506



BOWMAN 1
020301401



BOWMAN 2
020301402



BOWMAN 3
020301403



BOWMAN 4
020301404



BOWMAN 5
020301405



BOWMAN 6
020301406



Designed by Alan Perry

Not suitable for children under 36 months due to small parts and essential pointed components. All models supplied unpainted.
© Copyright Games Workshop Ltd., 1997. All rights reserved.

BRETONNIA™

MOUNTED SQUIRES COMMAND



**MOUNTED SQUIRE
CHAMPION**
020303401



**MOUNTED SQUIRE
HORN BLOWER**
020303601



**MOUNTED SQUIRE
STANDARD BEARER**
020303501



MOUNTED SQUIRE CHAMPION



FIGHTER SHIELD SPRUE
101635

A COMPLETE MOUNTED SQUIRE
COMMAND CONSISTS OF:
1 x MOUNTED SQUIRE COMMAND
1 x PLASTIC HORSE
1 x FIGHTER SHIELD SPRUE

GRAIL KNIGHT HERO ON FOOT



**GRAIL KNIGHT HERO
SHIELD**
020303202

GRAIL KNIGHT HERO
020303201

A COMPLETE GRAIL KNIGHT HERO
ON FOOT CONSISTS OF:
1 x GRAIL KNIGHT HERO
1 x GRAIL KNIGHT HERO SHIELD



QUESTING KNIGHT HEROES ON FOOT



**QUESTING KNIGHT HERO
ON FOOT**
020304001



**QUESTING KNIGHT HERO
ON FOOT 2**
079902101

A COMPLETE QUESTING KNIGHT
HERO ON FOOT CONSISTS OF:
1 x QUESTING KNIGHT HERO
1 x FIGHTER SHIELD SPRUE



**QUESTING KNIGHT HERO
SHIELD**
079902102

A COMPLETE QUESTING KNIGHT
HERO ON FOOT 2 CONSISTS OF:
1 x QUESTING KNIGHT HERO 2
1 x QUESTING KNIGHT HERO SHIELD



KNIGHT OF THE REALM HERO ON FOOT



**KNIGHT OF THE REALM HERO
ON FOOT**
020304101

A COMPLETE KNIGHT OF THE REALM
HERO ON FOOT CONSISTS OF:
1 x QUESTING KNIGHT HERO
1 x FIGHTER SHIELD SPRUE



BRETONNIA

MOUNTED SQUIRES



MOUNTED SQUIRE 1
020303301



MOUNTED SQUIRE 2
020303302



MOUNTED SQUIRE 3
020303303



MOUNTED SQUIRE 4
020303304



MOUNTED SQUIRE 5
020303305



MOUNTED SQUIRE 6
020303306



MOUNTED SQUIRE 7
020303307



MOUNTED SQUIRE 8
020303308



MOUNTED SQUIRE 9
020303309



MOUNTED SQUIRE 10
020303310



MOUNTED SQUIRE 11
020303311



MOUNTED SQUIRE 12
020303312



MOUNTED SQUIRE 13
020303313



MOUNTED SQUIRE 14
020303314



MOUNTED SQUIRE 15
020303315



MOUNTED SQUIRE
SPEAR ARM 1
020303316



MOUNTED SQUIRE
SPEAR ARM 2
020303317

A COMPLETE MOUNTED SQUIRE
CONSISTS OF:
1 x MOUNTED SQUIRE
1 x MOUNTED SQUIRE SPEAR ARM
1 x PLASTIC HORSE
1 x FIGHTER SHIELD SPRUE





BRETONNIAN MOUNTED SQUIRE



Designed by Alan Perry

Not suitable for children under 36 months due to small parts and essential pointed components. All models supplied unpainted.
© Copyright Games Workshop Ltd., 1997. All rights reserved.

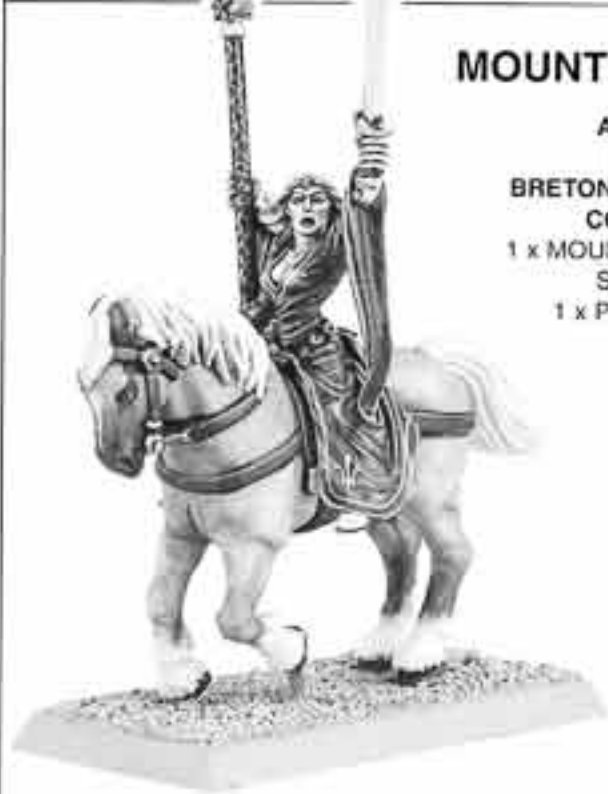
BRETONNIA

 <p>MOUNTED BRETONNIAN SORCERESS</p>	<p>MOUNTED SORCERESS</p> <p>A COMPLETE MOUNTED BRETONNIAN SORCERESS CONSISTS OF: 1 x MOUNTED BRETONNIAN SORCERESS 1 x PLASTIC HORSE</p>  <p>MOUNTED BRETONNIAN SORCERESS 020303101</p>	<p>SORCERESS</p>  <p>BRETONNIAN SORCERESS 020303001</p>
--	---	--

SQUIRES WITH BOWS COMMAND



SQUIRE WITH BOW CHAMPION
020305301



SQUIRE WITH BOW HORN BLOWER
020305402



SQUIRE WITH BOW STANDARD BEARER
020305401

SQUIRES WITH BOWS



SQUIRE WITH BOW 1
020305201



SQUIRE WITH BOW 2
020305202



SQUIRE WITH BOW 3
020305203



SQUIRE WITH BOW 4
020305204



SQUIRE WITH BOW 5
020305205



SQUIRE WITH BOW 6
020305206

Sorceress designed by Brian Nelson Squires designed by Michael Perry



BRETONNIA

HERO ON PEGASUS



HERO ON PEGASUS
UPPER BODY
020303701



HERO ON PEGASUS LEGS
020303703



HERO ON PEGASUS
LANCE ARM
020303707



HERO ON PEGASUS
SWORD ARM
020303702



HERO ON PEGASUS



PEGASUS RIGHT SIDE
020303705



PEGASUS LEFT SIDE
020303706



PEGASUS HEAD
020303704



PEGASUS RIGHT WING
020400808



PEGASUS LEFT WING
020400807



HERO ON PEGASUS
GRAIL SHIELD
020303708

- A COMPLETE HERO ON PEGASUS CONSISTS OF:
- 1 x HERO ON PEGASUS UPPER BODY
 - 1 x HERO ON PEGASUS LEGS
 - 1 x HERO ON PEGASUS LANCE ARM OR SWORD ARM
 - 1 x HERO ON PEGASUS GRAIL SHIELD
 - 1 x PEGASUS RIGHT SIDE
 - 1 x PEGASUS LEFT SIDE
 - 1 x PEGASUS HEAD
 - 1 x PEGASUS RIGHT WING
 - 1 x PEGASUS LEFT WING



BRETONNIA

LOUEN LEONCOEUR, KING OF BRETONNIA



UPPER BODY
020300102



CLOAK
020300103



SHIELD
020300104



LEGS
020300101



LOUEN LOENCOEUR, KING OF BRETONNIA



HIPPOGRIFF BODY RIGHT
020300105



HIPPOGRIFF BODY LEFT
020300106



HIPPOGRIFF RIGHT CLAW
020300109



HIPPOGRIFF TAIL
020300110

A COMPLETED LOUEN LEONCOEUR, KING OF BRETONNIA CONSISTS OF:

- 1 x UPPER BODY
- 1 x LEGS
- 1 x CLOAK
- 1 x SHIELD
- 1 x HIPPOGRIFF BODY RIGHT
- 1 x HIPPOGRIFF BODY LEFT
- 1 x HIPPOGRIFF RIGHT CLAW
- 1 x HIPPOGRIFF TAIL
- 1 x LEFT WING
- 1 x RIGHT WING



RIGHT WING
020300112

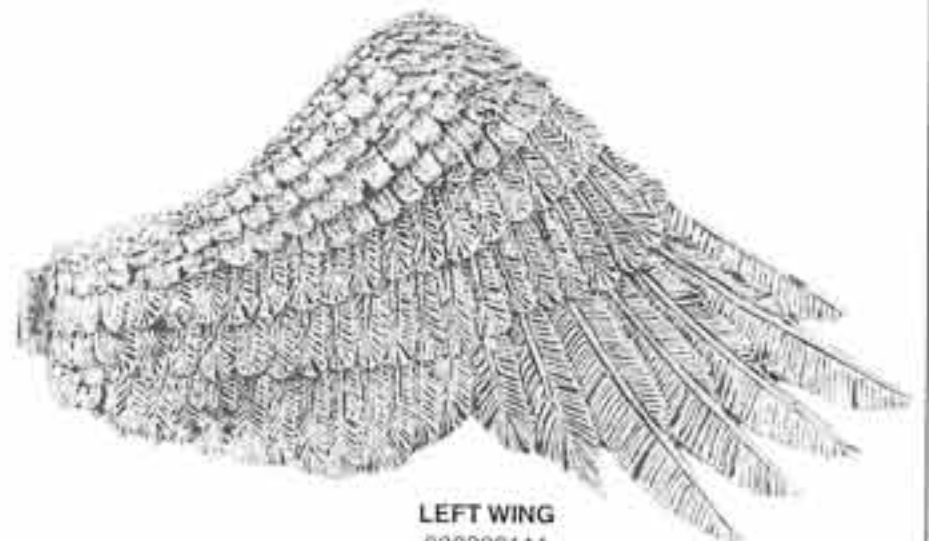

LEFT WING
020300111

BRETONNIA

THE GREEN KNIGHT



BODY
020302801



PENNANT POLES
020302802



LEGS
020302804



SHIELD
020302803



THE GREEN KNIGHT



HORSE HEAD
020302807

THE COMPLETED GREEN KNIGHT CONSISTS OF:
1 x BODY
1 x LEGS
1 x PENNANT POLES
1 x SHIELD
1 x HORSE HEAD
1 x HORSE RIGHT SIDE
1 x HORSE LEFT SIDE



HORSE RIGHT SIDE
020302805



HORSE LEFT SIDE
020302806

BRETONNIA

REPANSE DE LYONESSE



REPANSE DE LYONESSE BODY
020302907



REPANSE DE LYONESSE LANCE ARM
020302902



REPANSE DE LYONESSE LEGS
020302908



REPANSE DE LYONESSE SHIELD
020302903



REPANSE DE LYONESSE HORSE LEFT SIDE
020302904



REPANSE DE LYONESSE HORSE RIGHT SIDE
020302905



REPANSE DE LYONESSE HORSE HEAD
020302906

A COMPLETE REPANSE DE LYONESSE CONSISTS OF:

- 1 x REPANSE DE LYONESSE BODY
- 1 x REPANSE DE LYONESSE LEGS
- 1 x REPANSE DE LYONESSE LANCE ARM
- 1 x REPANSE DE LYONESSE SHIELD
- 1 x REPANSE DE LYONESSE HORSE LEFT SIDE
- 1 x REPANSE DE LYONESSE HORSE RIGHT SIDE
- 1 x REPANSE DE LYONESSE HORSE HEAD



REPANSE DE LYONESSE

Designed by Michael Perry

BRETONNIA

BERTRAND THE BRIGAND AND HIS FAITHFUL COMRADES



BERTRAND THE BRIGAND
020300701



HUGO LE PETIT
020300702

AN COMPLETE GUI LE GROS CONSISTS OF:
1 x GUI LE GROS BODY
1 x WINE BARREL



WINE BARREL
020300704



GUI LE GROS



GUI LE GROS BODY
020300703

MORGIANA LE FAY ENCHANTRESS



MORGIANA LE FAY
020300601



MORGIANA LE FAY'S CLOAK
020300602



LEFT UNICORN SIDE
020300603



MORGIANA LE FAY RIDING UNICORN



RIGHT UNICORN SIDE
020300604



TOAD
020300605

A COMPLETE MORGIANA LE FAY CONSISTS OF:
1 x MORGIANA LE FAY
1 x MORGIANA LE FAY'S CLOAK
1 x LEFT UNICORN SIDE
1 x RIGHT UNICORN SIDE
1 x TOAD



Bertrand and Morgiana Le Fay designed by Michael Perry, Unicorn designed by Trish Morrison

Not suitable for children under 36 months due to small parts and essential pointed components. All models supplied unpainted.
© Copyright Games Workshop Ltd., 1997. All rights reserved.

BRETONNIA™

TRISTRAN LE TROUBADOUR AND JULES LE JONGLEUR



TRISTRAN'S BODY
020304201



TRISTRAN'S LANCE
020304202



JULES LE JONGLEUR
020304205



TRISTRAN'S LUTE
020304204



TRISTRAN'S SHIELD
020304203

A COMPLETE TRISTRAN LE TROUBADOUR CONSISTS OF:

- 1 x TRISTRAN'S BODY
- 1 x TRISTRAN'S LANCE
- 1 x TRISTRAN'S LUTE
- 1 x TRISTRAN'S SHIELD
- 1 x BRETONNIAN HORSE SPRUE
- 1 x JULES LE JONGLEUR



TRISTRAN LE TROUBADOUR

BARON ODO D'OUTREMER



ODO D'OUTREMER'S BODY
020304301

A COMPLETE BARON ODO D'OUTREMER CONSISTS OF:

- 1 x ODO D'OUTREMER'S BODY
- 1 x ODO D'OUTREMER'S SHIELD
- 1 x BRETONNIAN HORSE SPRUE



ODO D'OUTREMER'S SHIELD
020304302



BARON ODO D'OUTREMER

SULIMAN LE SARACEN



SULIMAN'S BODY
020304401

A COMPLETE SULIMAN LE SARACEN CONSISTS OF:

- 1 x SULIMAN'S BODY
- 1 x SULIMAN'S SHIELD
- 1 x PLASTIC HORSE



SULIMAN'S SHIELD
020304402



SULIMAN LE SARACEN



CITADEL
MINIATURES



CITADEL
MINIATURES

WARHAMMER REGIMENT

CHAOS WARRIORS



SHOWN ABOVE ARE ONLY A FEW EXAMPLES OF THE MANY POSSIBLE WAYS YOU CAN ASSEMBLE YOUR CHAOS WARRIORS.



CHAOS WARRIOR
STANDARD BEARER ARM
020106003



CHAOS WARRIOR
STANDARD TOP
020106002



CHAOS WARRIOR
LEADER HEAD
020106001



CHAOS WARRIOR
LEADER AXE
020106004



CHAOS WARRIOR
HORN BLOWER ARM
020106001

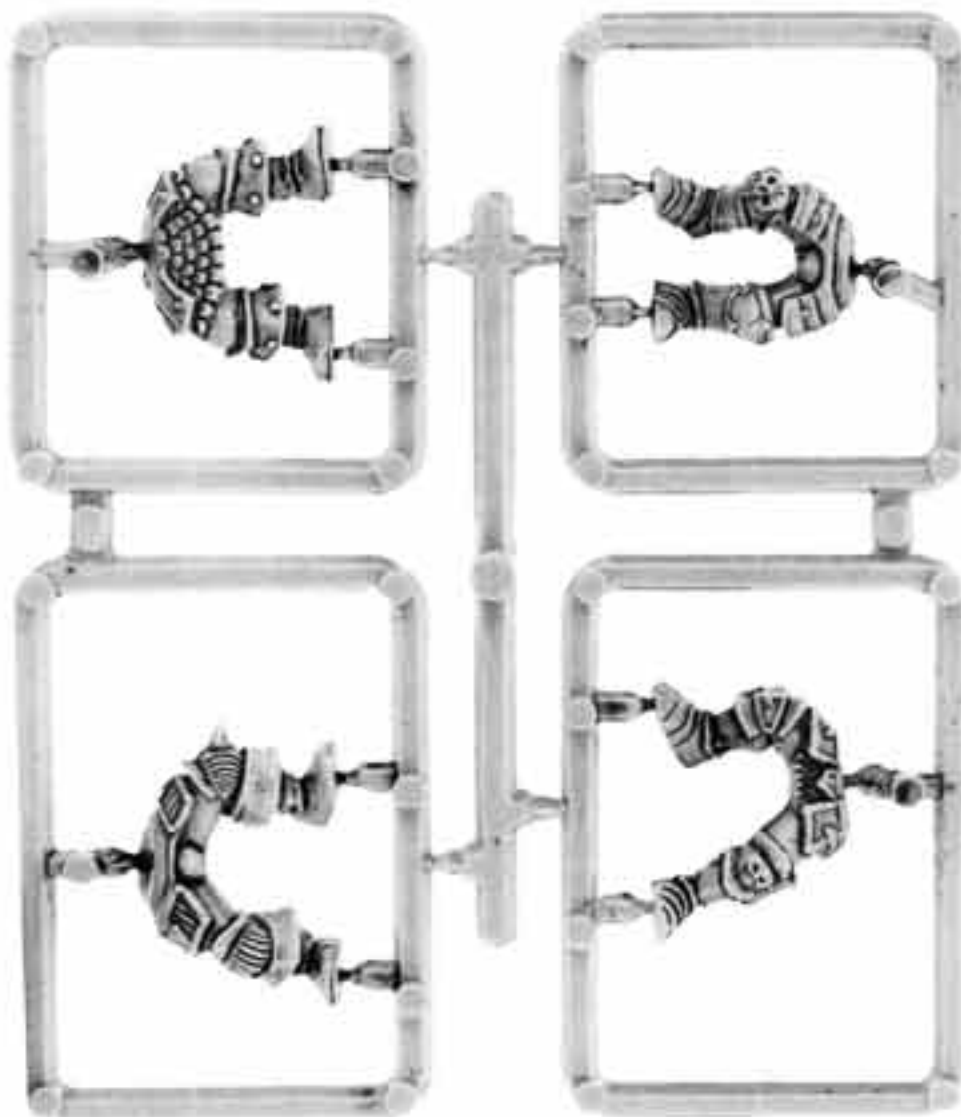

CHAOS WARRIOR LEG SPRUE
99380201003

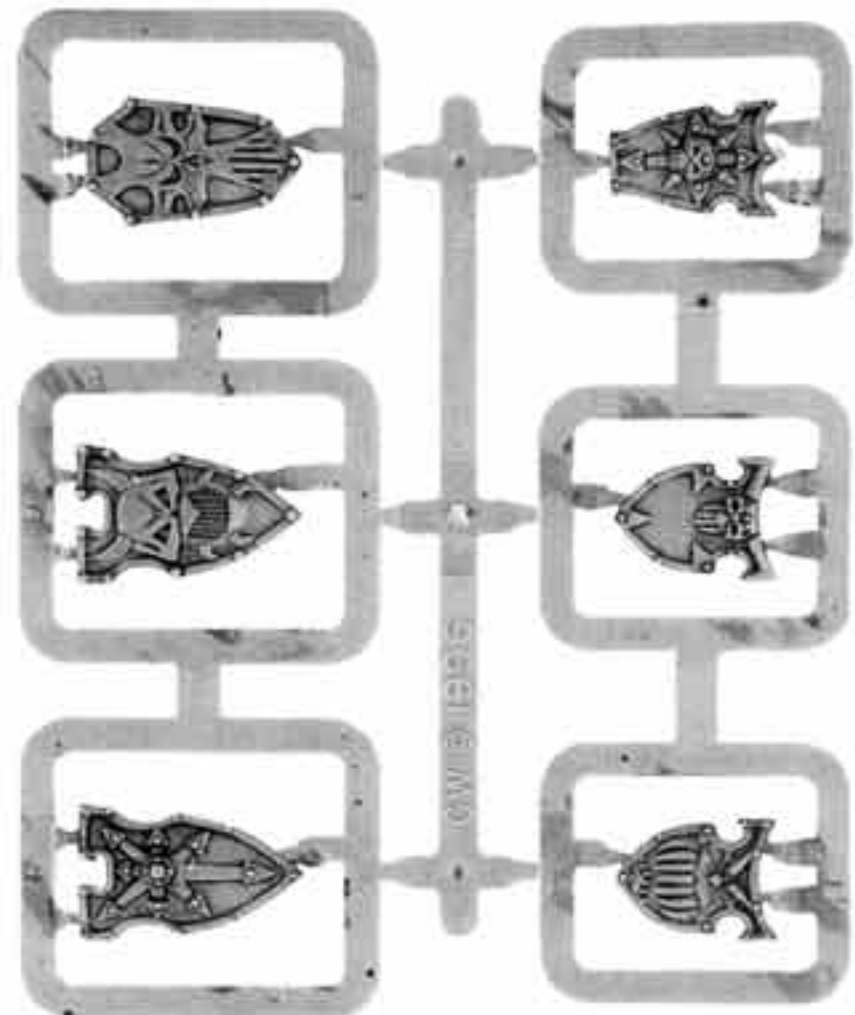

CHAOS WARRIORSHIELD SPRUE
99380201007

ALL THE CHAOS WARRIOR SPRUES ARE SHOWN AT 80% OF ACTUAL SIZE

THE BOXED SET CONSISTS OF:

3 x CHAOS WARRIOR LEG SPRUES, 3 x BODY SPRUES, 2 x SHIELD SPRUES, 2 x RIGHT ARM SPRUES, 2 x LEFT ARM SPRUES, 2 x HEAD SPRUES, 2 x ACCESSORY SPRUES, 1 x STANDARD BEARER ARM, 1 x STANDARD TOP, 1 x LEADER HEAD, 1 x LEADER AXE, 1 x HORN BLOWER ARM. YOU GET ENOUGH PLASTIC SPRUES AND METAL ACCESSORIES FOR A COMPLETE REGIMENT OF 12 CHAOS WARRIORS INCLUDING A COMMAND GROUP.



Designed by Aly Morrison and Dave Andrews

275

Not suitable for children under 36 months due to small parts and essential pointed components. All models supplied unpainted.

© Copyright Games Workshop Ltd., 1997. All rights reserved.

WARHAMMER REGIMENT

CHAOS WARRIORS

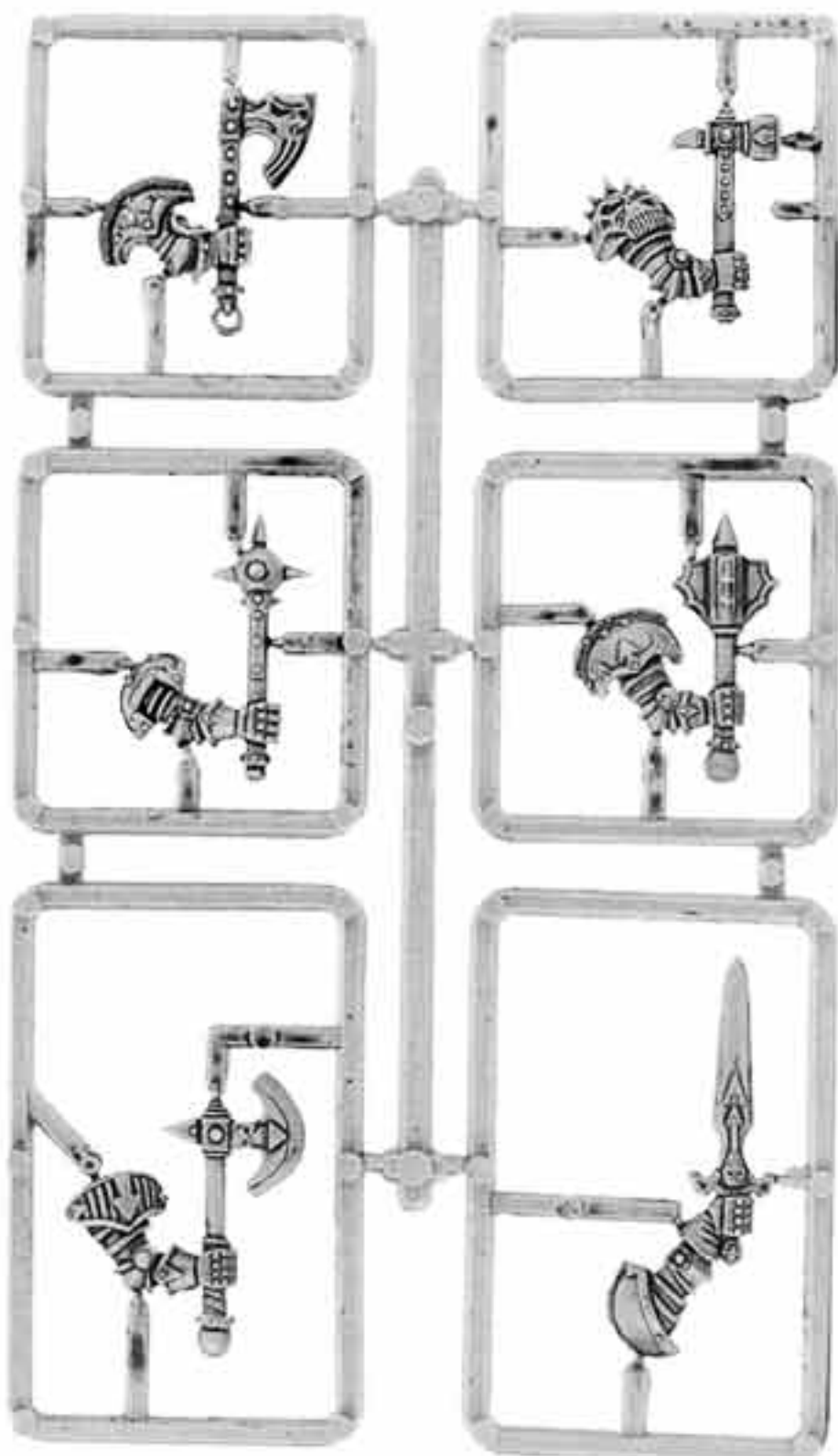

CHAOS WARRIOR RIGHT ARM SPRUE
99380201004

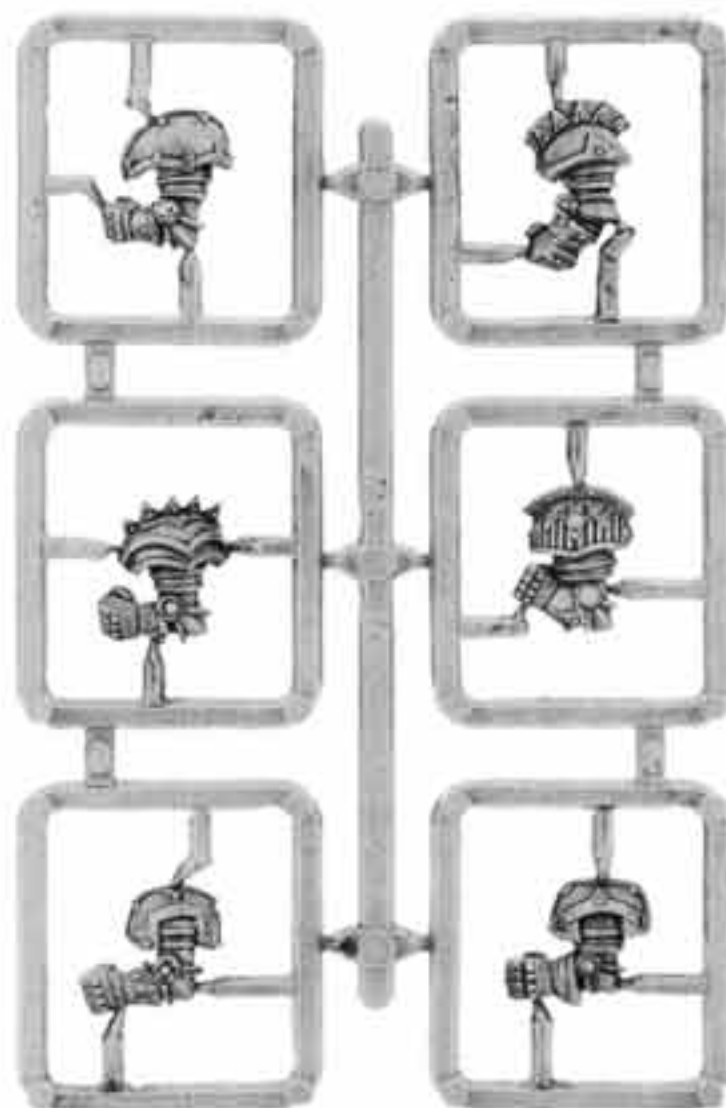

CHAOS WARRIOR LEFT ARM SPRUE
99380201005

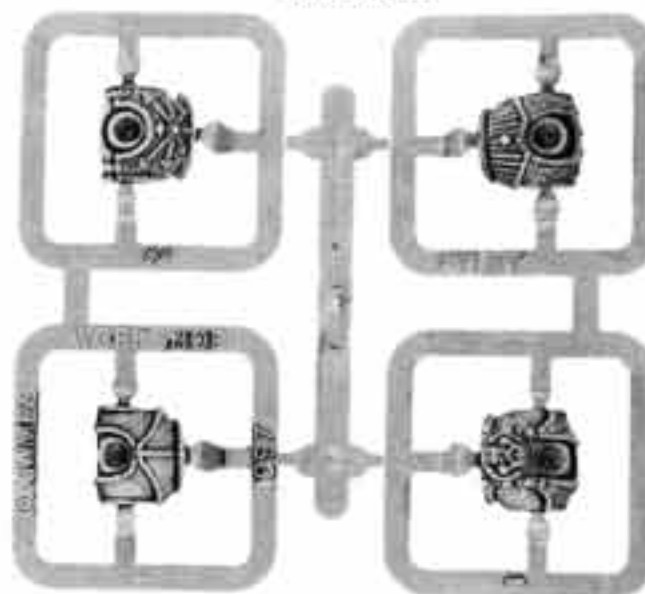

CHAOS WARRIOR BODY SPRUE
99380201002

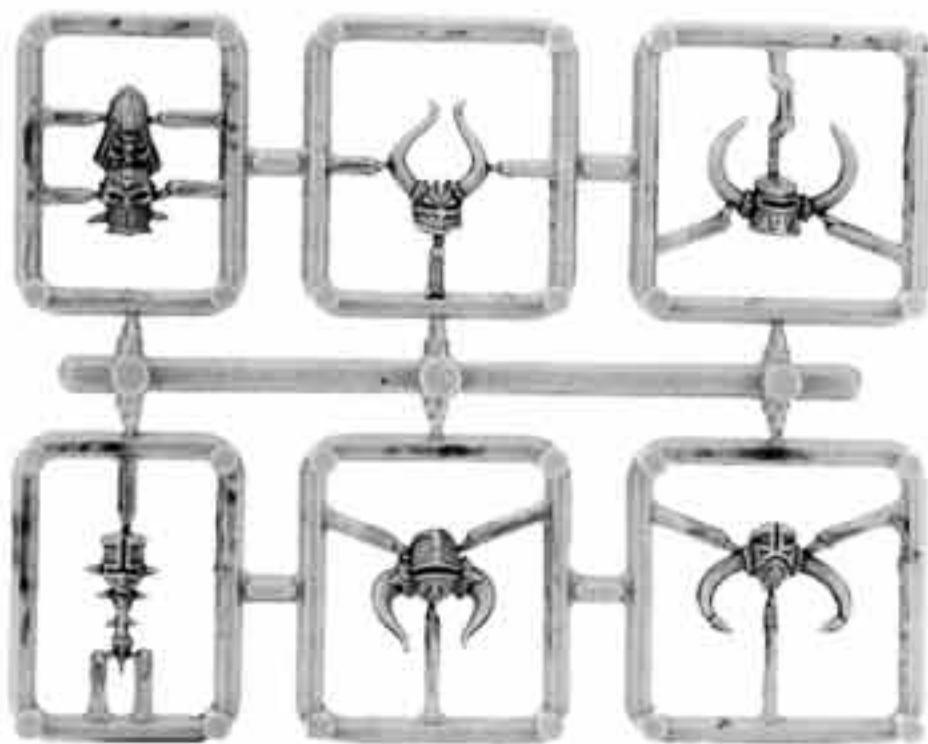

CHAOS WARRIOR HEAD SPRUE
99380201001

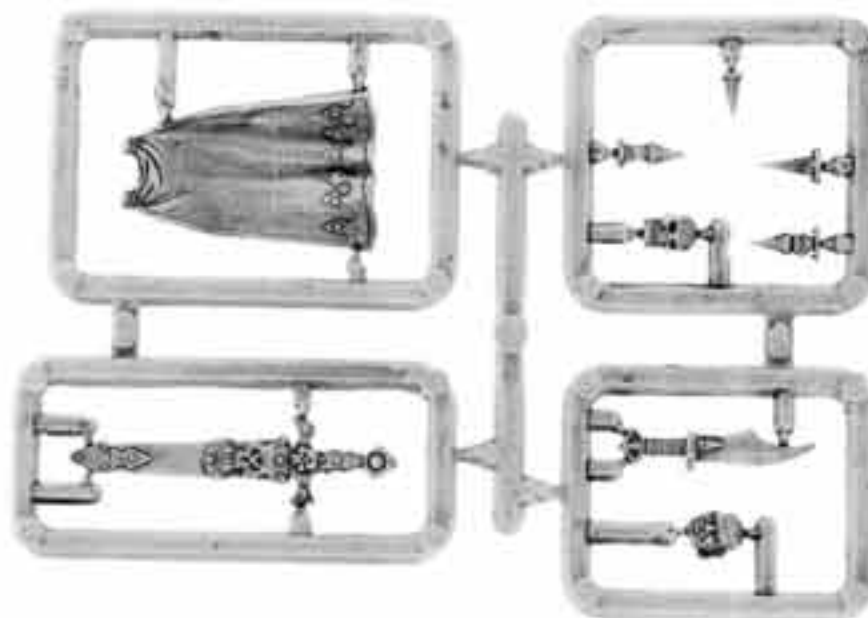

CHAOS WARRIOR SPECIAL SPRUE
99380201006

THE CHAOS WARRIOR SPECIAL SPRUE CONSISTS OF:
4 x SPIKES, 1 x SKULL, 1 x KNIFE, 1 x BARE HEAD,
1 x SWORD IN SCABBARD, 1 x CLOAK



WARHAMMER REGIMENT

CHAOS WARRIORS WITH HALBERDS



CHAOS WARRIOR
HALBERD ARM 1
020108306



CHAOS WARRIOR
HALBERD ARM 2
020108307



CHAOS WARRIOR
HALBERD ARM 3
020108308



CHAOS WARRIOR
STANDARD ARM
020108303



CHAOS WARRIOR
STANDARD TOP
020108304



CHAOS WARRIOR
LEADER HEAD
020108301



CHAOS WARRIOR
LEADER MACE
020108302



CHAOS WARRIOR
HORN BLOWER ARM
020108305



A COMPLETE REGIMENT OF CHAOS WARRIOR HALBERDIERS

THE BOXED SET CONSISTS OF:

3 x CHAOS WARRIOR LEG SPRUES, 3 x BODY SPRUES, 2 x SHIELD SPRUES, 2 x RIGHT ARM SPRUES, 2 x LEFT ARM SPRUES, 2 x HEAD SPRUES, 2 x ACCESSORY SPRUES, 12 x HALBERDS, 1 x STANDARD BEARER ARM, 1 x STANDARD TOP, 1 x LEADER HEAD, 1 x LEADER AXE, 1 x HORN BLOWER ARM. YOU GET ENOUGH PLASTIC SPRUES AND METAL ACCESSORIES FOR A COMPLETE REGIMENT OF 12 CHAOS WARRIORS INCLUDING A COMMAND GROUP.

Designed by Aly Morrison and Dave Andrews

Not suitable for children under 8 years due to small parts and essential pointed components. All models supplied unpainted.
© Copyright Games Workshop Ltd. 1998. All rights reserved.



WARHAMMER REGIMENT

CHAOS KNIGHTS



CHAOS KNIGHT
LEGS 1
020107703



CHAOS KNIGHT
LEGS 2
020107704



CHAOS KNIGHT STEED
HEAD 1
020107701



CHAOS KNIGHT STEED
HEAD 2
020107702



CHAOS KNIGHT LANCE ARM
020106601



CHAOS KNIGHT
STANDARD TOP
020106603



CHAOS KNIGHT
CHAMPION HEAD
020106605



CHAOS KNIGHT STANDARD ARM
020106602



CHAOS KNIGHT
CHAMPION SWORD ARM
020106604



CHAOS KNIGHT HORN
BLOWER ARM
020106606



CHAOS KNIGHT CHAMPION



CHAOS KNIGHT



CHAOS KNIGHT STANDARD BEARER

THE BOXED SET CONSISTS OF:

2 x CHAOS WARRIOR BODY SPRUES, 1 x CHAOS WARRIOR LEFT ARM SPRUE, 1 x CHAOS WARRIOR ACCESSORY SPRUE, 1 x CHAOS WARRIOR HEAD SPRUE, 5 x ARMoured PLASTIC HORSES, 1 x CHAOS WARRIOR SHIELD SPRUE, 3 x CHAOS KNIGHT LEGS 1, 2 x CHAOS KNIGHT LEGS 2, 5 x CHAOS KNIGHT LANCE ARMS, 1 x CHAOS KNIGHT STANDARD ARM, 2 x CHAOS KNIGHT STEED HEAD 1, 3 x CHAOS KNIGHT STEED HEAD 2, 1 x CHAOS KNIGHT STANDARD TOP, 1 x CHAOS KNIGHT CHAMPION HEAD, 1 x CHAOS KNIGHT HORNBLOWER ARM, 1 x CHAOS KNIGHT CHAMPION SWORD ARM, 1 x ADHESIVE COLOUR BANNER.

CHAOS

CHAOS WARRIORS

THESE MINIATURES ARE SUPPLIED
WITH PLASTIC CHAOS SHIELDS



CHAOS WARRIOR 2
020106302



CHAOS WARRIOR 1
020106301



CHAOS WARRIOR 3
020106303

CHAOS MARAUDERS WITH TWO-HANDED WEAPONS



CHAOS MARAUDER WITH
DOUBLE HANDED AXE 1
020106201



CHAOS MARAUDER WITH
DOUBLE HANDED AXE 2
020106202



CHAOS MARAUDER WITH
DOUBLE HANDED MACE
020106203



CHAOS MARAUDER WITH
DOUBLE HANDED AXE 3
020106204



CHAOS MARAUDER WITH
DOUBLE HANDED AXE 4
020106205



Designed by Dave Andrews

CHAOS

CHAOS MARAUDERS WITH FLAILS



CHAOS MARAUDER
WITH FLAIL 1
020105701



CHAOS MARAUDER
WITH FLAIL 2
020105702



CHAOS MARAUDER
WITH FLAIL 3
020105703



CHAOS MARAUDER
WITH FLAIL 4
020105707

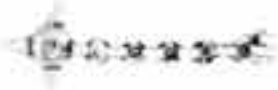

CHAOS MARAUDER
FLAIL TOP 1
020105704



CHAOS MARAUDER
FLAIL TOP 2
020105705



CHAOS MARAUDER
FLAIL TOP 3
020105706

A COMPLETE CHAOS
MARAUDER CONSISTS
OF:
1 x CHAOS MARAUDER
BODY
1 x CHAOS MARAUDER
FLAIL TOP

CHAOS MARAUDER COMMAND



CHAOS MARAUDER
DRUMMER
020105801



CHAOS MARAUDER
STANDARD BEARER BODY
020105802



CHAOS MARAUDER
STANDARD BEARER



CHAOS MARAUDER
STANDARD BEARER TOP
020105803

A COMPLETE CHAOS MARAUDER
STANDARD BEARER CONSISTS OF:
1 x CHAOS MARAUDER
STANDARD BEARER BODY
1 x CHAOS MARAUDER
STANDARD BEARER TOP

CHAOS

CHAOS CHAMPIONS



CHAOS CHAMPION
BODY
020106101



CHAOS CHAMPION
BANNER POLE
020106103

THE COMPLETE
CHAOS CHAMPION
CONSISTS OF:
1 x CHAOS CHAMPION
BODY
1 x CHAOS CHAMPION
MACE ARM
1 x CHAOS CHAMPION
BANNER POLE



CHAOS CHAMPION
MACE ARM
020106102



CHAOS CHAMPION



CHAOS CHAMPION 2
079901401



Designed by Dave Andrews

Not suitable for children under 8 years due to small parts and essential pointed components. All models supplied unpainted.
© Copyright Games Workshop Ltd. 1998. All rights reserved.

CHAOS

CHAOS SORCERERS



CHAOS SORCERER BODY 1
020103801



CHAOS SORCERER SWORD 1
020103803



CHAOS SORCERER HEAD 1
020103804



CHAOS SORCERER STAFF 1
020103802

**A COMPLETE CHAOS SORCERER 1
CONSISTS OF:**
1 x CHAOS SORCERER BODY 1
1 x CHAOS SORCERER SWORD 1
1 x CHAOS SORCERER STAFF 1
1 x CHAOS SORCERER HEAD 1



CHAOS SORCERER 1



SORCERER BODY 2
020103805



CHAOS SORCERER SWORD 2
020103807



CHAOS SORCERER HEAD 2
020103808



CHAOS SORCERER STAFF 2
020103806

**A COMPLETE CHAOS SORCERER 2
CONSISTS OF:**
1 x CHAOS SORCERER BODY 2
1 x CHAOS SORCERER SWORD 2
1 x CHAOS SORCERER STAFF 2
1 x CHAOS SORCERER HEAD 2



CHAOS SORCERER 2



CHAOS SORCERER BODY 3
020103809



CHAOS SORCERER ARM
020103810



SORCERER HEAD 3
020103811



CHAOS SORCERER 3

**A COMPLETE
CHAOS SORCERER 3 CONSISTS OF:**
1 x CHAOS SORCERER BODY 3
1 x CHAOS SORCERER ARM 3
1 x CHAOS SORCERER HEAD 3



CHAOS

CHAOS WARRIOR CHARIOT



CHAOS WARRIOR
CREWMAN WITH AXE
020107301



CHAOS WARRIOR
WHIP ARM
020107303



CHAOS WARRIOR
WHIP CREWMAN
020107302



CHAOS WARRIOR
CHARIOT HAFT
020107304



CHAOS WARRIOR
CHARIOT FAIRING
020107305



CHAOS WARRIOR
CHARIOT LEFT FAIRING
020107306



CHAOS WARRIOR
CHARIOT RIGHT FAIRING
020107307



CHAOS WARRIOR
CHARIOT BASE
020107308



CHAOS WARRIOR
CHARIOT YOKE
020107309



CHAOS WARRIOR
CHARIOT WHEEL
020107310



CHAOS WARRIOR
CHARIOT WHEEL SCYTHE
020107311



CHAOS KNIGHT STEED
HEAD 2
020107702



CITADEL
MINIATURES



CITADEL
MINIATURES

Crew designed by Dave Andrews, Chariot designed by Norman Swales

Not recommended for children under 8 years due to small parts and essential pointed components. All models supplied unpainted.
© Copyright Games Workshop Ltd, 1998. All rights reserved.

CHAOS

CHAOS WARRIOR CHARIOT



THE COMPLETE CHAOS WARRIOR CHARIOT CONSISTS OF:

- 1 x CHAOS WARRIOR CREWMAN WITH AXE
- 1 x CHAOS WARRIOR WHIP CREWMAN
- 1 x CHAOS WARRIOR WHIP ARM
- 1 x CHAOS WARRIOR CHARIOT HAFT
- 1 x CHAOS WARRIOR CHARIOT FAIRING
- 1 x CHAOS WARRIOR CHARIOT LEFT FAIRING
- 1 x CHAOS WARRIOR CHARIOT RIGHT FAIRING
- 1 x CHAOS WARRIOR CHARIOT BASE
- 1 x CHAOS WARRIOR CHARIOT YOKE
- 2 x CHAOS WARRIOR CHARIOT WHEELS
- 2 x CHAOS WARRIOR CHARIOT WHEEL SCYTHES
- 2 x CHAOS WARRIOR CHARIOT STEED HEADS
- 2 x PLASTIC ARMoured HORSE SPRUES
- 2 x PLASTIC ARMoured HORSE TAIL SPRUES



CHAOS

CHAOS LORD ON CHAOS STEED



CHAOS LORD BODY
020105001



CHAOS LORD LEFT ARM
020105004



CHAOS LORD RIGHT ARM
020105003



CHAOS LORD SHIELD
020105005



CHAOS LORD HEAD
020105002

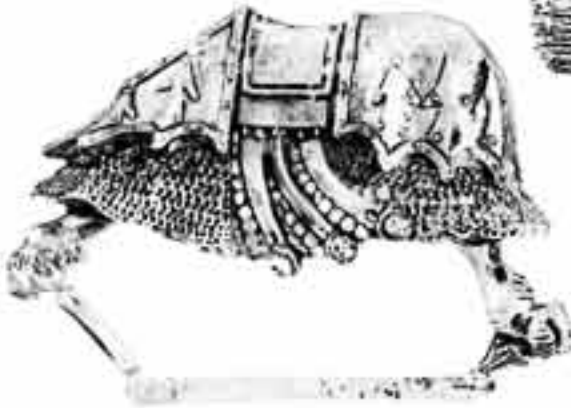

CHAOS STEED BODY LEFT SIDE
020105007



CHAOS STEED BODY RIGHT SIDE
020105006



CHAOS STEED HEAD
020105008

A COMPLETE CHAOS LORD ON CHAOS STEED CONSISTS OF:

- 1 x CHAOS LORD BODY
- 1 x CHAOS LORD HEAD
- 1 x CHAOS LORD LEFT ARM
- 1 x CHAOS LORD RIGHT ARM
- 1 x CHAOS LORD SHIELD
- 1 x CHAOS STEED BODY LEFT SIDE
- 1 x CHAOS STEED BODY RIGHT SIDE
- 1 x CHAOS STEED HEAD



CHAOS LORD ON CHAOS STEED

Designed by Aly Morrison



CHAOS

CHAOS BEASTMEN



**BEASTMAN
HORNBLOWER 1**
020100207



**BEASTMAN
SHAMAN 2**
020100402



**BEASTMAN
HORNBLOWER 2**
020100208



**BEASTMAN
CHAMPION 2**
020100302



**BEASTMAN
CHAMPION 1**
020100301

A COMPLETED BEASTMAN
STANDARD BEARER
CONSISTS OF:
1 x BEASTMAN
STANDARD BEARER
1 x BEASTMAN BANNER TOP



**BEASTMAN
STANDARD BEARER 2**
020100204



**BEASTMAN
STANDARD BEARER 1**
020100203



BEASTMAN 2
020102802



**BEASTMAN
SHAMAN 1**
020100401



BEASTMAN 4
020102804



BEASTMAN BANNER TOP 1
020100205



BEASTMAN BANNER TOP 2
020100206



BEASTMAN 7
020102807



BEASTMAN 3
020102803



BEASTMAN 5
020102805



BEASTMAN 8
020102808



BEASTMAN 6
020102806



BEASTMAN 1
020102801

THESE MODELS ARE SUPPLIED WITH APPROPRIATE PLASTIC SHIELDS AS STANDARD



CHAOS

BEAST LORD

A COMPLETE BEAST LORD CONSISTS OF:
1 x BEAST LORD BODY
1 x BEAST LORD BANNER
1 x BEAST LORD AXE



BEAST LORD BODY
020103901



BEAST LORD BANNER
020103903



BEAST LORD AXE
020103902



BEAST LORD

Designed by Michael Perry



CHAOS

BESTIGOR



BESTIGOR 1
020105301



BESTIGOR 2
020105302



BESTIGOR 3
020105303

BESTIGOR COMMAND GROUP



**BESTIGOR HORN BLOWER
BODY**
020105401



**BESTIGOR STANDARD
BEARER BODY**
020105403



BESTIGOR STANDARD BEARER TOP
020105404



BESTIGOR HORN BLOWER ARM
020105402



BESTIGOR HORN BLOWER

**A COMPLETE
BESTIGOR STANDARD
BEARER CONSISTS OF:**
1 x BESTIGOR
STANDARD BEARER
BODY
1 x BESTIGOR
STANDARD BEARER
TOP

**A COMPLETE BESTIGOR
HORN BLOWER
CONSISTS OF:**
1 x BESTIGOR HORN
BLOWER BODY
1 x BESTIGOR HORN
BLOWER ARM



BESTIGOR STANDARD BEARER



CHAOS

UNGOR WITH SPEARS COMMAND



UNGOR WITH SPEAR
HORN BLOWER
020104101



UNGOR
STANDARD BEARER 1
020104102



UNGOR
STANDARD BEARER 2
020104103

A COMPLETE UNGOR STANDARD
BEARER CONSISTS OF:
1 x UNGOR STANDARD BEARER
1 x UNGOR STANDARD TOP



UNGOR
STANDARD TOP
020104104



UNGOR WITH SPEAR
STANDARD BEARER

UNGOR WITH SPEAR

A COMPLETE UNGOR WITH SPEAR
CONSISTS OF:
1 x UNGOR WITH SPEAR
1 x SMALL ROUND PLASTIC SHIELD



UNGOR WITH SPEAR 1
020104001



UNGOR WITH SPEAR 2
020104002



UNGOR WITH SPEAR 3
020104003



UNGOR WITH SPEAR 4
020104004



UNGOR WITH SPEAR 5
020104005



UNGOR WITH SPEAR 6
020104006



UNGOR WITH SPEAR 7
020104007



UNGOR WITH SPEAR 8
020104008



UNGOR WITH SPEAR 9
020104009



UNGOR WITH SPEAR



Designed by Alan Perry

CHAOS

UNGOR SKIRMISHERS



UNGOR SKIRMISHER
HORNBLOWER
020105601



UNGOR SKIRMISHER 1
020105501



UNGOR SKIRMISHER 2
020105502



UNGOR SKIRMISHER 3
020105503



UNGOR SKIRMISHER 4
020105504



UNGOR STANDARD
020104104



UNGOR STANDARD BEAERER 1
020104102

A COMPLETE UNGOR
STANDARD BEARER
CONSISTS OF:
1 x UNGOR STANDARD BEARER
1 x UNGOR STANDARD



UNGOR SKIRMISHER 5
020105505



UNGOR SKIRMISHER 6
020105506



UNGOR SKIRMISHER 7
020105507



UNGOR SKIRMISHER 8
020105508



UNGOR SKIRMISHER 9
020105509

THESE MINIATURES ARE SUPPLIED WITH SMALL PLASTIC SHIELDS



REGIMENT OF UNGOR SKIRMISHERS



CITADEL
MINIATURES



CITADEL
MINIATURES

CHAOS

BEASTMAN CHARIOT



BEASTMAN GOR
CREWMAN WITH TWO
HANDED AXE
020106701



BEASTMAN GOR CREWMAN WITH
WHIP SWORD ARM
020106703



BEASTMAN CHARIOT
HAFT
020106706



BEASTMAN GOR
CREWMAN WITH WHIP
020106702

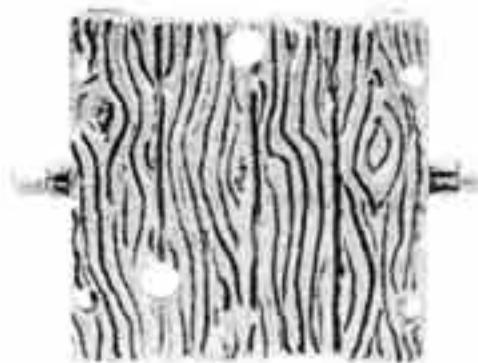

BEASTMAN
CHARIOT BASE
020106704



PLASTIC SPOKED
WHEEL
993999059



BEASTMAN CHARIOT YOKE
020106705



BEASTMAN CHARIOT
SIDE 2
020106708



BEASTMAN CHARIOT
SIDE 3
020106709



BEASTMAN CHARIOT
SIDE 1
020106707



BEASTMAN CHARIOT
TUSKGOR 1 HEAD
020106710



BEASTMAN CHARIOT
TUSKGOR 1 JAW
020106711



BEASTMAN CHARIOT
TUSKGOR 2 HORNS
020106712



BEASTMAN CHARIOT
TUSKGOR 2 HEAD
020106713

CHAOS

BEASTMAN CHARIOT



BEASTMAN CHARIOT

- A COMPLETE BEASTMAN CHARIOT CONSISTS OF:**
- 1 x BEASTMAN CHARIOT CREW WITH TWO-HANDED AXE
 - 1 x BEASTMAN CREWMAN WITH WHIP
 - 1 x BEASTMAN CREWMAN WITH WHIP SWORD ARM
 - 1 x BEASTMAN CHARIOT HAFT
 - 1 x BEASTMAN CHARIOT BASE
 - 1 x BEASTMAN CHARIOT YOKE
 - 2 x BEASTMAN CHARIOT SIDES
 - 1 x BEASTMAN CHARIOT TUSKGOR 1 HEAD
 - 1 x BEASTMAN CHARIOT TUSKGOR 1 JAWS
 - 1 x BEASTMAN CHARIOT TUSKGOR 2 HORNS
 - 1 x BEASTMAN CHARIOT TUSKGOR 2 HEAD
 - 2 x PLASTIC BOARDS
 - 2 x PLASTIC SPOKED WHEELS

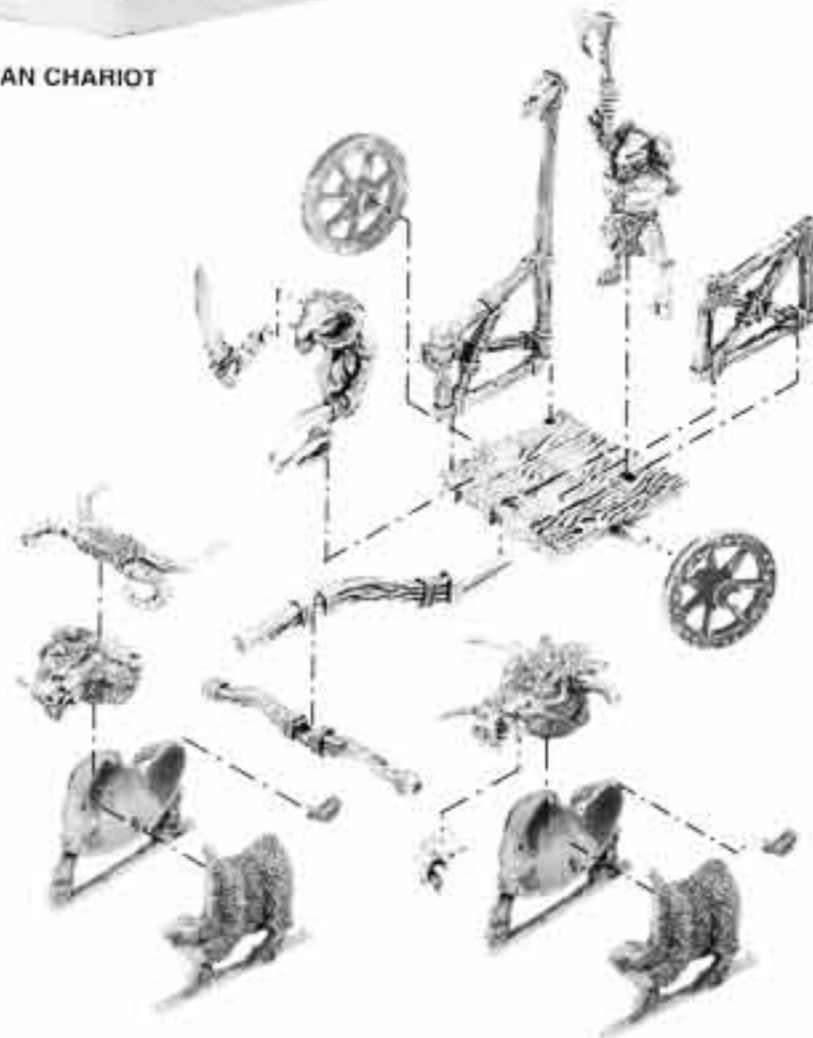

Designed by Norman Swales, Trish Morrison and Michael Perry

Not suitable for children under 8 years due to small parts and essential pointed components. All models supplied unpainted.
© Copyright Games Workshop Ltd. 1998. All rights reserved.



CITADEL
MINIATURES



CITADEL
MINIATURES

CHAOS

MINOTAUR LORD



MINOTAUR LORD LEGS
020104505



MINOTAUR LORD BODY
020104503



MINOTAUR LORD HEAD
020104501



MINOTAUR LORD JAW
020104502



MINOTAUR LORD SHOULDER
020104504



MINOTAUR LORD

A COMPLETE MINOTAUR LORD CONSISTS OF:

- 1 x MINOTAUR LORD HEAD
- 1 x MINOTAUR LORD JAW
- 1 x MINOTAUR LORD BODY
- 1 x MINOTAUR LORD LEGS
- 1 x MINOTAUR LORD RIGHT ARM
- 1 x MINOTAUR LORD LEFT ARM
- 1 x MINOTAUR LORD SHOULDER



MINOTAUR LORD LEFT ARM
020104506



MINOTAUR LORD RIGHT ARM
020104507



CHAOS

MINOTAURS



MINOTAUR BODY 1
020104401



MINOTAUR BODY 2
020104402



MINOTAUR BODY 3
020104403



MINOTAUR

A COMPLETE MINOTAUR A CONSISTS OF:
1 x MINOTAUR BODY 1
1 x MINOTAUR HEAD 1
1 x MINOTAUR RIGHT ARM



MINOTAUR RIGHT ARM
WITH CLEAVER
020104409



MINOTAUR RIGHT ARM
WITH AXE
020104410



MINOTAUR RIGHT ARM
WITH SWORD
020104411

A COMPLETE MINOTAUR B CONSISTS OF:
1 x MINOTAUR BODY 2 OR 3
1 x COMPLETE MINOTAUR HEAD 2 OR
MINOTAUR HEAD 3
1 x MINOTAUR RIGHT ARM



MINOTAUR JAW
020104407



MINOTAUR HEAD 2
020104405



MINOTAUR HEAD 1
020104404



MINOTAUR HEAD 3
020104408

A COMPLETE MINOTAUR HEAD 2
CONSISTS OF:
1 x MINOTAUR HEAD 2
1 x MINOTAUR HORNS
1 x MINOTAUR JAW

MINOTAUR HORNS
020104406

MINOTAUR STANDARD BEARER



MINOTAUR STANDARD TOP
020107205



MINOTAUR STANDARD
BEARER SWORD ARM
020107201



MINOTAUR
STANDARD ARM
020107204

A COMPLETE MINOTAUR
STANDARD BEARER
CONSISTS OF:
1 x MINOTAUR
STANDARD BEARER BODY
1 x MINOTAUR STANDARD
BEARER SWORD ARM
1 x MINOTAUR
STANDARD TOP
1 x MINOTAUR
STANDARD BEARER HEAD
1 x MINOTAUR STANDARD
BEARER STANDARD ARM



MINOTAUR STANDARD BEARER
HEAD
020107202



MINOTAUR
STANDARD BEARER BODY
020107201



MINOTAUR STANDARD BEARER



CITADEL
MINIATURES



CITADEL
MINIATURES

CHAOS

MINOTAURS WITH ADDITIONAL HAND WEAPON



MINOTAUR WITH ADDITIONAL
HAND WEAPON BODY 1
020104301



MINOTAUR WITH ADDITIONAL
HAND WEAPON BODY 2
020104302



MINOTAUR WITH ADDITIONAL
HAND WEAPON BODY 3
020104303



MINOTAUR WITH ADDITIONAL
HAND WEAPON HEAD 1
020104304



MINOTAUR WITH ADDITIONAL
HAND WEAPON HEAD 2
020104305



MINOTAUR WITH ADDITIONAL
HAND WEAPON LEFT ARM 1
020104310



MINOTAUR WITH ADDITIONAL
HAND WEAPON RIGHT ARM 1
020104307

A COMPLETE MINOTAUR WITH ADDITIONAL HAND WEAPON 1 CONSISTS OF:

- 1 x MINOTAUR WITH ADDITIONAL HAND WEAPON BODY 1 OR 2
- 1 x MINOTAUR WITH ADDITIONAL HAND WEAPON HEAD 1 OR 2
- 1 x MINOTAUR WITH ADDITIONAL HAND WEAPON RIGHT ARM
- 1 x MINOTAUR WITH ADDITIONAL HAND WEAPON LEFT ARM



MINOTAUR WITH ADDITIONAL
HAND WEAPON HEAD 3
020104306

A COMPLETE MINOTAUR WITH ADDITIONAL HAND WEAPON 2 CONSISTS OF:

- 1 x MINOTAUR WITH ADDITIONAL HAND WEAPON BODY 3
- 1 x MINOTAUR WITH ADDITIONAL HAND WEAPON HEAD 3
- 1 x MINOTAUR WITH ADDITIONAL HAND WEAPON RIGHT ARM
- 1 x MINOTAUR WITH ADDITIONAL HAND WEAPON LEFT ARM



MINOTAUR WITH ADDITIONAL
HAND WEAPON LEFT ARM 2
020104311



MINOTAUR WITH ADDITIONAL
HAND WEAPON RIGHT ARM 2
020104308



MINOTAUR WITH ADDITIONAL HAND WEAPON



MINOTAUR WITH ADDITIONAL
HAND WEAPON LEFT ARM 3
020104312



MINOTAUR WITH ADDITIONAL
HAND WEAPON RIGHT ARM 3
020104309



CITADEL
MINIATURES



CITADEL
MINIATURES

Designed by Trish Morrison

Not suitable for children under 8 years due to small parts and essential pointed components. All models supplied unpainted.
© Copyright Games Workshop Ltd. 1998. All rights reserved.

CHAOS

MINOTAURS WITH TWO HANDED WEAPONS



MINOTAUR WITH TWO HANDED WEAPON BODY 1
020104201



MINOTAUR WITH TWO HANDED WEAPON BODY 2
020104202



MINOTAUR WITH TWO HANDED WEAPON BODY 3
020104203

COMPLETE MINOTAUR WITH TWO HANDED WEAPON HEAD 1



MINOTAUR WITH TWO HANDED WEAPON HEAD 1
020104205



MINOTAUR WITH TWO HANDED WEAPON HEAD 2
020104207



MINOTAUR WITH TWO HANDED WEAPON HEAD 3
020104208



MINOTAUR WITH TWO HANDED WEAPON JAW
020104206



MINOTAUR WITH TWO HANDED WEAPON LEG
020104204



MINOTAUR WITH TWO HANDED WEAPON WEAPON ARMS 1
020104209



MINOTAUR WITH TWO HANDED WEAPON WEAPON ARMS 2
020104210



MINOTAUR WITH TWO HANDED WEAPON WEAPON ARMS 3
020104211



MINOTAUR WITH TWO HANDED WEAPON

A COMPLETE MINOTAUR WITH TWO HANDED WEAPON 1 CONSISTS OF:

- 1 x MINOTAUR WITH TWO HANDED WEAPON BODY 1 OR 2
- 1 x MINOTAUR WITH TWO HANDED WEAPON COMPLETE HEAD 1 OR MINOTAUR WITH TWO HANDED WEAPON HEAD 2
- 1 x MINOTAUR WITH TWO HANDED WEAPON WEAPON ARMS

A COMPLETE MINOTAUR WITH TWO HANDED WEAPON 2 CONSISTS OF:

- 1 x MINOTAUR WITH TWO HANDED WEAPON BODY 3
- 1 x MINOTAUR WITH TWO HANDED WEAPON HEAD 3
- 1 x MINOTAUR WITH TWO HANDED WEAPON WEAPON ARMS

CHAOS

CHAOS HOUNDS



CHAOS HOUND 1
BODY LEFT
020108101



CHAOS HOUND 1
BODY RIGHT
020108102



COMPLETED
CHAOS HOUND 1



CHAOS HOUND 1
TAIL
020108103

A COMPLETE
CHAOS HOUND 1
CONSISTS OF:
1 x CHAOS HOUND 1 BODY RIGHT
1 x CHAOS HOUND 1 BODY LEFT
1 x CHAOS HOUND 1 TAIL



CHAOS HOUND 2
HEAD
020108104



CHAOS HOUND 2
TAIL
020108115



CHAOS HOUND 3
HEAD
020108108



CHAOS HOUND 3
TAIL
020108111



CHAOS HOUND 2
BODY RIGHT
020108105



CHAOS HOUND 2
BODY LEFT
020108106



CHAOS HOUND 3
BODY RIGHT
020108109



CHAOS HOUND 3
BODY LEFT
020108110



CHAOS HOUND 4
HEAD
020108112



CHAOS HOUND 4
TAIL
020108107

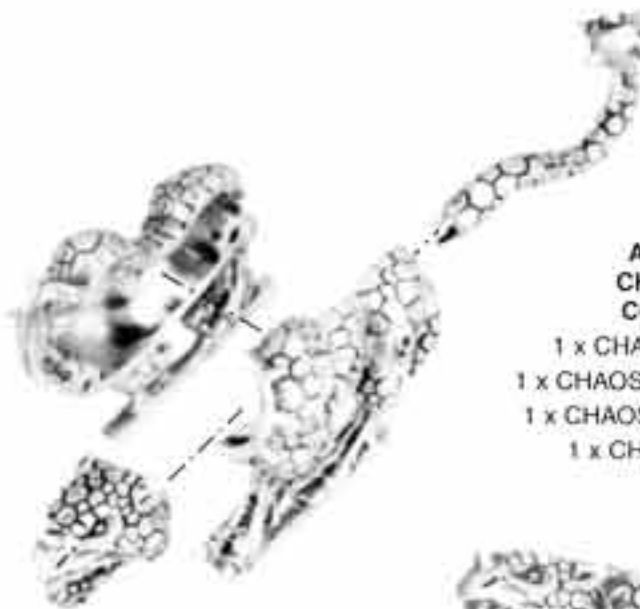

A COMPLETE
CHAOS HOUND
CONSISTS OF:
1 x CHAOS HOUND HEAD*
1 x CHAOS HOUND BODY RIGHT
1 x CHAOS HOUND BODY LEFT
1 x CHAOS HOUND TAIL



CHAOS HOUND 4
BODY RIGHT
020108113



CHAOS HOUND 4
BODY LEFT
020108114

*NOTE: CHAOS HOUND 1'S
HEAD COMES WITH
THE LEFT SIDE OF ITS
BODY



COMPLETED
CHAOS HOUND 3



Designed by Trish Morrison

Not recommended for children under 8 years due to small parts and essential pointed components. All models supplied unpainted.
© Copyright Games Workshop Ltd. 1998. All rights reserved.

CHAOS

DRAGON OGRES



OGRE TORSO A1
020100504



OGRE TORSO A2
020100512



DRAGON OGRE ARM 'A'
020100505



OGRE TORSO B1
020100506



OGRE TORSO B2
020100513



DRAGON OGRE ARM 'B'
020100507



OGRE TORSO C1
020100514



OGRE TORSO C2
020100508



DRAGON OGRE ARM 'C'
020100509



DRAGON OGRE LEG 1
020100502



DRAGON OGRE LEG 2
020100515

LEG 1 FITS BODY 1
LEG 2 FITS BODY 2



DRAGON OGRE CLAW 1
020100503



DRAGON OGRE CLAW 2
020100511

A COMPLETED DRAGON OGRE
CONSISTS OF:

- 1 x OGRE TORSO
- 1 x WEAPON ARM
- 1 x DRAGON OGRE BODY
- 1 x DRAGON OGRE LEG
- 1 x DRAGON OGRE CLAW

ARM 'A' FITS TORSOS A1 AND A2 ONLY; ARM 'B' FITS TORSO B1 AND B2; ARM 'C' FITS TORSOS C1 AND C2



DRAGON OGRE BODY 1
020100501



DRAGON OGRE BODY 2
020100510



EXAMPLE OF A COMPLETED DRAGON OGRE



CHAOS

CHAOS SPAWN

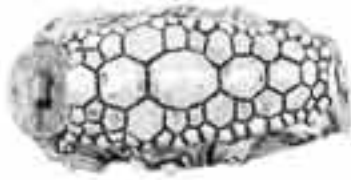

CHAOS SPAWN BODY 1
020104901



CHAOS SPAWN BODY 2
020104902



CHAOS SPAWN NECK JOINT
020104903



CHAOS SPAWN TAIL JOINT
020104904



CHAOS SPAWN HEAD 1
020104905



CHAOS SPAWN HEAD 2
020104906



CHAOS SPAWN HEAD 3
020104907



CHAOS SPAWN HEAD 4
020104908



CHAOS SPAWN HEAD 5
020104909



CHAOS SPAWN HEAD 6
020104910



CHAOS SPAWN HEAD 7
020104911



CHAOS SPAWN HEAD 8
020104924



CHAOS SPAWN TAIL 1
020104912



CHAOS SPAWN TAIL 2
020104913



CHAOS SPAWN TAIL 3
020104914



CHAOS SPAWN TAIL 4
020104915



CHAOS SPAWN TAIL 5
020104916



CHAOS SPAWN
RIGHT LEG 1
020104917



CHAOS SPAWN
RIGHT LEG 2
020104918



CHAOS SPAWN
RIGHT LEG 3
020104919



CHAOS SPAWN
RIGHT LEG 4
020104920



CHAOS SPAWN
LEFT LEG 1
020104921



CHAOS SPAWN
LEFT LEG 2
020104922



CHAOS SPAWN
LEFT LEG 3
020104923

A COMPLETE CHAOS SPAWN CONSISTS OF:

- 1 x CHAOS SPAWN BODY
- 3 x PAIRS OF CHAOS SPAWN LEGS IF YOU CHOOSE BODY 1 OR
- 2 x PAIRS OF CHAOS SPAWN LEGS IF YOU CHOOSE BODY 2
- 5 x CHAOS SPAWN HEADS
- 3 x CHAOS SPAWN TAILS
- 1 x CHAOS SPAWN NECK JOINT
- 1 x CHAOS SPAWN TAIL JOINT

THE CHAOS SPAWN IS A CREATURE OF MANY RANDOM HORRIBLE FORMS AND DEFORMATIONS SO PLEASE FEEL FREE TO USE A TAIL AS A HEAD, A HEAD AS A LEG OR ANY OTHER COMBINATION YOU CAN THINK OF!



CHAOS SPAWN



Designed by Trish Morrison

CHAOS

BLOODTHIRSTER, GREATER DAEMON OF KHORNE



BLOODTHIRSTER HEAD
020106401



BLOODTHIRSTER BODY
020106402



BLOODTHIRSTER LEGS
020106403



BLOODTHIRSTER WHIP OF KHORNE
020106404



BLOODTHIRSTER TABARD
020106405



BLOODTHIRSTER AXE OF KHORNE
020106406



BLOODTHIRSTER WHIP HAND
020106407



BLOODTHIRSTER LEFT WING
020106408



BLOODTHIRSTER RIGHT WING
020106409



CITADEL
MINIATURES



CITADEL
MINIATURES

CHAOS

BLOODTHIRSTER, GREATER DAEMON OF KHORNE



**THE COMPLETE
BLOODTHIRSTER,
GREATER DAEMON OF KHORNE CONSISTS OF:**

- 1 x BLOODTHIRSTER HEAD
- 1 x BLOODTHIRSTER BODY
- 1 x BLOODTHIRSTER LEGS
- 1 x BLOODTHIRSTER WHIP OF KHORNE
- 1 x BLOODTHIRSTER TABARD
- 1 x BLOODTHIRSTER AXE OF KHORNE
- 1 x BLOODTHIRSTER WHIP HAND
- 1 x BLOODTHIRSTER LEFT WING
- 1 x BLOODTHIRSTER RIGHT WING

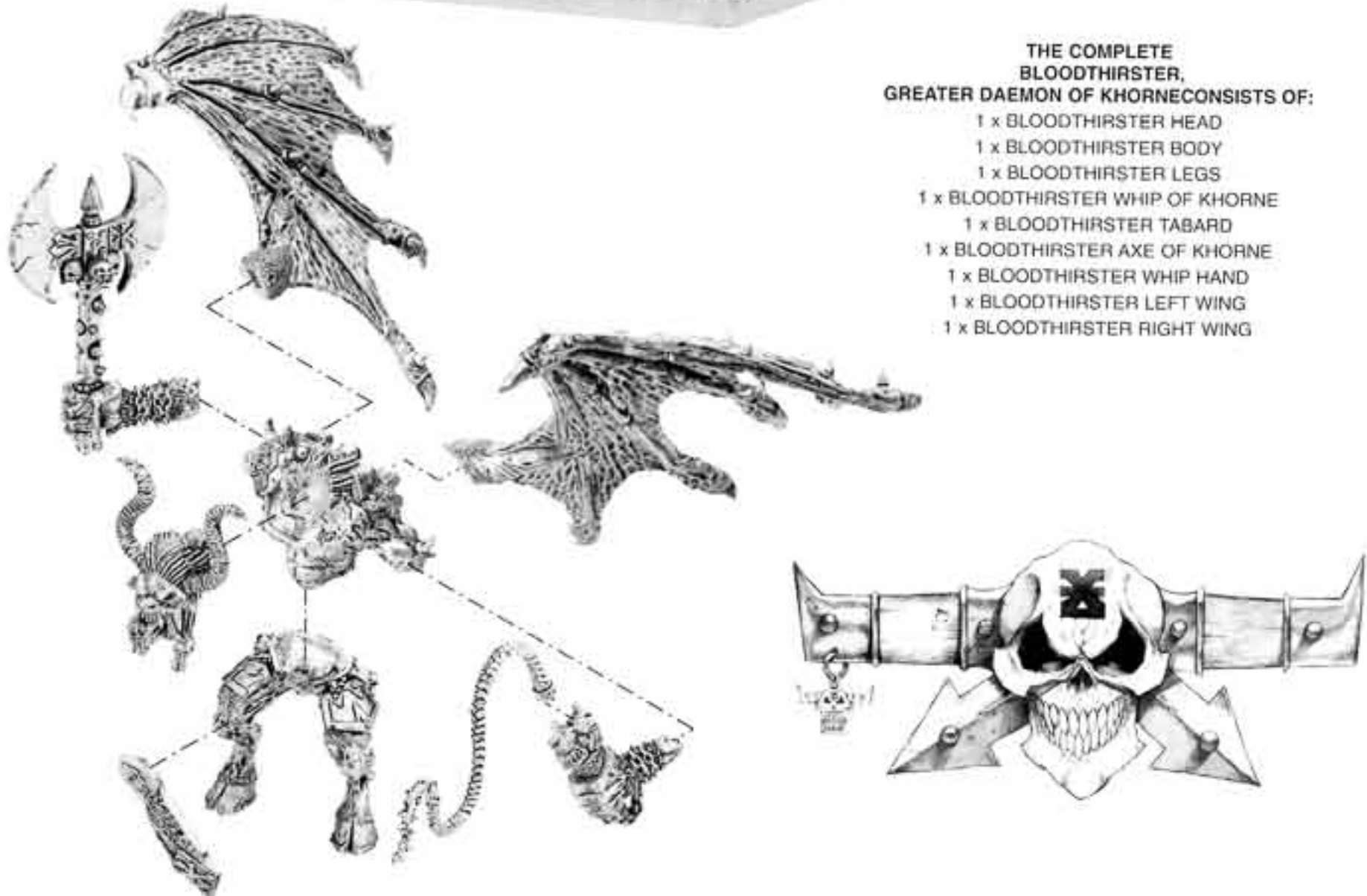

Designed by Trish Morrison

Not recommended for children under 8 years due to small parts and essential pointed components. All models supplied unpainted.
© Copyright Games Workshop Ltd. 1998. All rights reserved.

CHAOS

BLOODLETTER COMMAND GROUP



**BLOODLETTER
CHAMPION BODY**
020107001



**BLOODLETTER
CHAMPION LEFT ARM**
020107004



**BLOODLETTER
CHAMPION HEAD**
020107002



**BLOODLETTER
CHAMPION SWORD ARM**
020107003

**THE COMPLETE
BLOODLETTER CHAMPION
CONSISTS OF:**
1 x BLOODLETTER CHAMPION
BODY
1 x BLOODLETTER CHAMPION
LEFT ARM
1 x BLOODLETTER CHAMPION
HEAD
1 x BLOODLETTER CHAMPION
SWORD ARM



BLOODLETTER CHAMPION



**BLOODLETTER
STANDARD BEARER**
020106901

**THE COMPLETE
BLOODLETTER STANDARD BEARER
CONSISTS OF:**
1 x BLOODLETTER
STANDARD BEARER
1 x BLOODLETTER
STANDARD



**BLOODLETTER
STANDARD**
020106902



**BLOODLETTER
WITH BLOODHORN**
020106903



**BLOODLETTER
STANDARD BEARER**

BLOODLETTERS



BLOODLETTER 2
020100903



BLOODLETTER 4
020100901



BLOODLETTER 6
020100906



BLOODLETTER 1
020100904



BLOODLETTER 5
020100905



BLOODLETTER 3
020100902



BLOODLETTER 7
020100907



CHRONICLE
MANUFACTURED



CTADE
MANUFACTURED

CHAOS

FLESH HOUNDS OF KHORNE



KHORNE FLESH HOUND 1



KHORNE FLESH HOUND 2



KHORNE FLESH HOUND 3



FLESH HOUND 1 LEFT BODY
020100810



FLESH HOUND 2 LEFT BODY
020100801



FLESH HOUND 3 LEFT BODY
020100806



FLESH HOUND 1 RIGHT BODY
020100811



FLESH HOUND 2 RIGHT BODY
020100802



FLESH HOUND 3 RIGHT BODY
020100807



FLESH HOUND 1 RUFF
020100814



FLESH HOUND 2 RUFF
020100805



FLESH HOUND 3 TAIL
020100809



FLESH HOUND 1 TAIL
020100813



FLESH HOUND 2 TAIL
020100804



FLESH HOUND 1 HEAD
020100812



FLESH HOUND 2 HEAD
020100803



FLESH HOUND 3 HEAD
020100808



TADEL
MINIATURES



CITADEL
MINIATURES

Designed by Trish Morrison

CHAOS

GREAT UNCLEAN ONE GREATER DAEMON OF NURGLE



HEAD
020103103



TONGUE TIP
020103111



CHAIN & SKULLS
020103109



LEFT HAND WITH CHAIN
020103108



UPPER TORSO
020103101



RIGHT ARM
020103104



LEFT ARM
020103107



RIGHT LEG
020103106



LEFT LEG
020103105



LOWER TORSO
020103102



TONGUE
020103110



CITADEL
MINIATURES



CITADEL
MINIATURES

CHAOS

GREAT UNCLEAN ONE GREATER DAEMON OF NURGLE

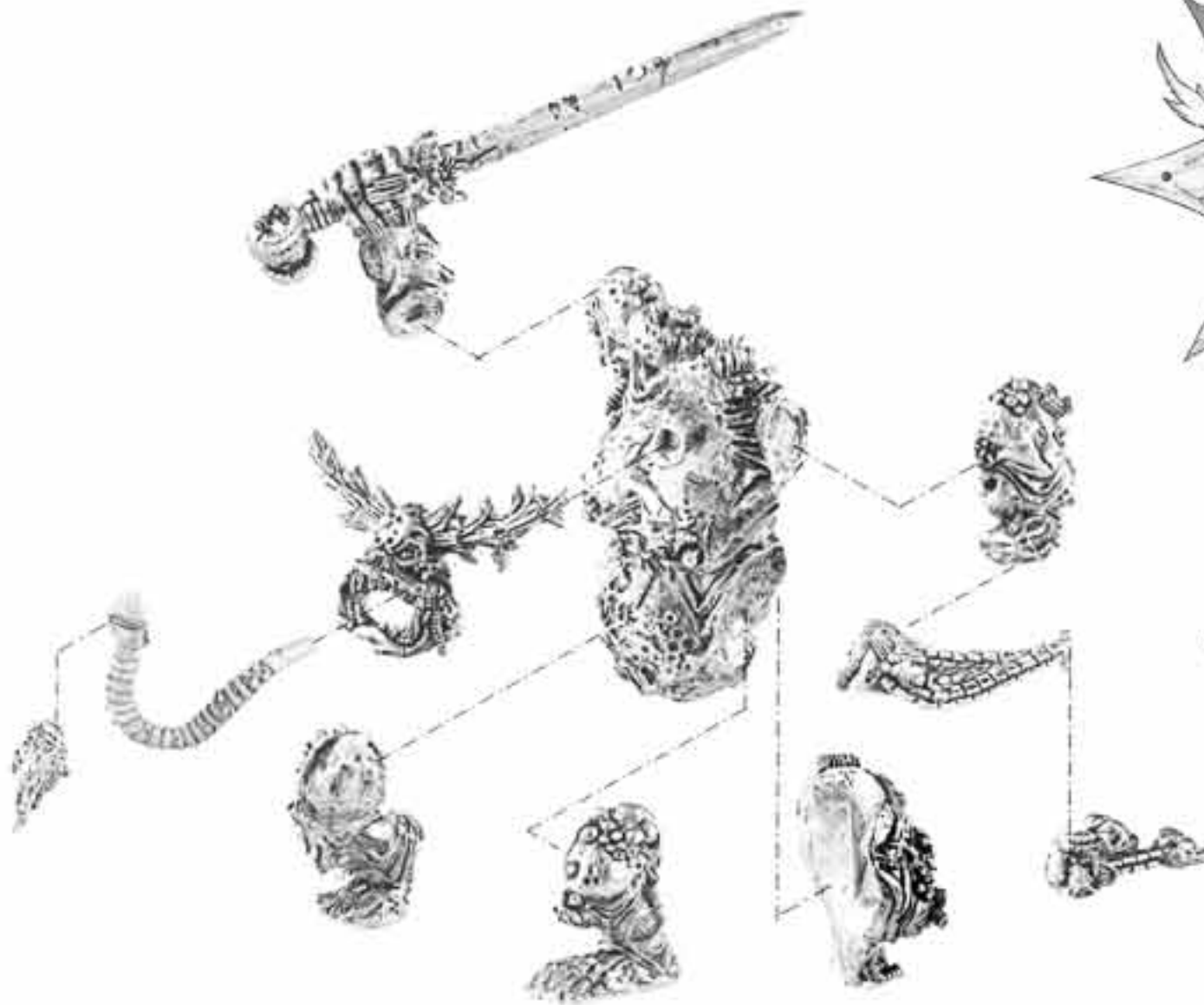

A COMPLETED GREATER DAEMON OF NURGLE CONSISTS OF :

- 1 x HEAD
- 1 x UPPER TORSO
- 1 x LOWER TORSO
- 1 x RIGHT ARM
- 1 x LEFT ARM
- 1 x LEFT HAND WITH CHAIN
- 1 x CHAIN & SKULLS
- 1 x RIGHT LEG
- 1 x LEFT LEG
- 1 x TONGUE
- 1 x TONGUE TIP
- 2 x NURGLINGS

NURGLINGS



NURGLING 1
020102201



NURGLING 2
020102202



NURGLING 3
020102203



NURGLING 4
020102204



NURGLING 5
020102205



NURGLING 6
020102206



A COMPLETED NURGLING BASE CONSISTS OF :
9 x NURGLINGS



NURGLING 7
020102207



NURGLING 8
020102208



NURGLING 9
020102209



Designed by Trish Morrison

Not suitable for children under 36 months due to small parts and essential pointed components. All models supplied unpainted.
© Copyright Games Workshop Ltd., 1997. All rights reserved.

CHAOS

DAEMON PRINCE



DAEMON PRINCE
LEGS 1
020104801



DAEMON PRINCE
LEGS 2
020104802



DAEMON PRINCE
LEFT ARM 1
020104808



DAEMON PRINCE
RIGHT WING
020104816



DAEMON PRINCE
LEFT WING
020104817



DAEMON PRINCE
TORSO 1
020104803



DAEMON PRINCE
TORSO 2
020104804



DAEMON PRINCE
LEFT ARM 2
020104809



DAEMON PRINCE
AXE
020104810



DAEMON PRINCE
SWORD
020104811

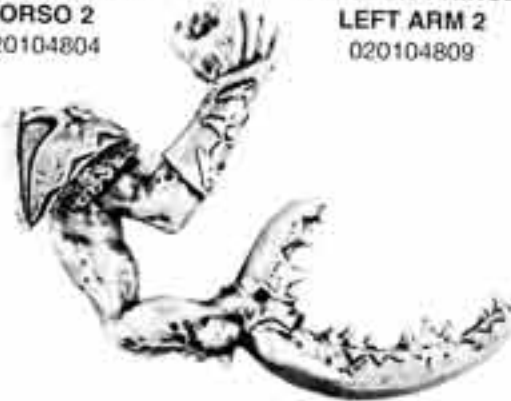

DAEMON PRINCE
RIGHT ARM 2
020104813



DAEMON PRINCE
RIGHT ARM 1
020104812



DAEMON PRINCE
TAIL 1
020104814



DAEMON PRINCE
TAIL 2
020104815



DAEMON PRINCE I
HEAD 1
020104805



DAEMON PRINCE
HAIR
020104806



DAEMON PRINCE
HEAD 2
020104807



A COMPLETE DAEMON PRINCE CONSISTS OF:

- 1 x DAEMON PRINCE LEGS
- 1 x DAEMON PRINCE TORSO
- 1 x DAEMON PRINCE LEFT ARM
- 1 x DAEMON PRINCE RIGHT ARM
- 1 x DAEMON PRINCE WEAPON
- 1 x DAEMON PRINCE TAIL
- 1 x DAEMON PRINCE
RIGHT WING
- 1 x DAEMON PRINCE
LEFT WING
- 1 x DAEMON PRINCE
HEAD 1 AND HAIR
OR HEAD 2



DAEMON PRINCE

CHAOS

GREATER DAEMON OF TZEENTCH



GREATER DAEMON OF
TZEENTCH NECK
020103602



GREATER DAEMON OF
TZEENTCH HEAD
020103603



GREATER DAEMON OF
TZEENTCH TABARD FRONT
020103609



GREATER DAEMON OF
TZEENTCH TABARD BACK
020103610



GREATER DAEMON OF TZEENTCH BODY
020103601



GREATER DAEMON OF TZEENTCH RIGHT ARM
020103606



GREATER DAEMON OF TZEENTCH SLEEVE
020103607



GREATER DAEMON OF
TZEENTCH RIGHT LEG
020103605



GREATER DAEMON OF
TZEENTCH LEFT LEG
020103611



GREATER DAEMON OF
TZEENTCH STAFF TOP
020103604



GREATER DAEMON OF
TZEENTCH CLAWS
020103612



GREATER DAEMON OF
TZEENTCH STAFF
020103608



GREATER DAEMON OF TZEENTCH LEFT WING
020103613

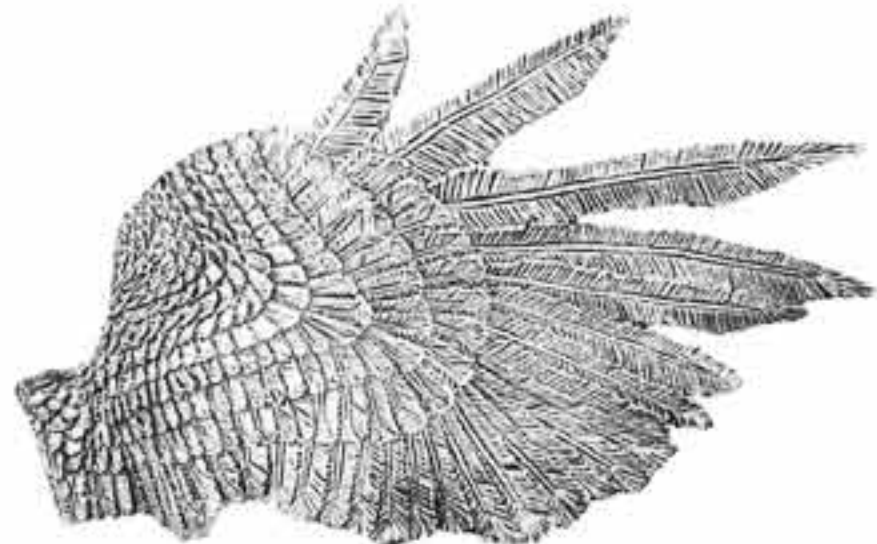

GREATER DAEMON OF TZEENTCH RIGHT WING
020103614



CITADEL
MINIATURES



CITADEL
MINIATURES

Designed by Trish Morrison

CHAOS

GREATER DAEMON OF TZEENTCH



GREATER DAEMON OF TZEENTCH



A COMPLETE GREATER DAEMON OF TZEENTCH CONSISTS OF:

- 1 x GREATER DAEMON OF TZEENTCH BODY
- 1 x GREATER DAEMON OF TZEENTCH NECK
- 1 x GREATER DAEMON OF TZEENTCH HEAD
- 1 x GREATER DAEMON OF TZEENTCH STAFF TOP
- 1 x GREATER DAEMON OF TZEENTCH RIGHT LEG
- 1 x GREATER DAEMON OF TZEENTCH LEFT LEG
- 1 x GREATER DAEMON OF TZEENTCH CLAWS
- 1 x GREATER DAEMON OF TZEENTCH RIGHT ARM
- 1 x GREATER DAEMON OF TZEENTCH SLEEVE
- 1 x GREATER DAEMON OF TZEENTCH STAFF
- 1 x GREATER DAEMON OF TZEENTCH TABARD FRONT
- 1 x GREATER DAEMON OF TZEENTCH TABARD BACK
- 1 x GREATER DAEMON OF TZEENTCH RIGHT WING
- 1 x GREATER DAEMON OF TZEENTCH LEFT WING

CHAOS

FLAMERS OF TZEENTCH



FLAMER BODY 1
020101201



FLAMER BODY 2
020101202



FLAMER BODY 3
020101207



FLAMER BODY 4
020101208



FLAMER RIGHT ARM 1
020101206



FLAMER RIGHT ARM 2
020101204



FLAMER RIGHT ARM 3
020101209



FLAMER RIGHT ARM 4
020101210



A COMPLETE
FLAMER OF TZEENTCH CONSISTS OF:
1 x FLAMER BODY
1 x FLAMER RIGHT ARM
1 x FLAMER LEFT ARM



FLAMER LEFT ARM 1
020101203



FLAMER LEFT ARM 2
020101205



FLAMER LEFT ARM 3
020101212



FLAMER LEFT ARM 4
020101211

PLAGUEBEARERS OF NURGLE



PLAGUEBEARER 1
020101603



PLAGUEBEARER 2
020101604



PLAGUEBEARER 3
020101602



PLAGUEBEARER 4
020101601



PLAGUEBEARER 5
020101605



PLAGUEBEARER 6
020101606



PLAGUEBEARER 7
020101607



PLAGUEBEARER 8
020101608



Designed by Aly Morrison

Not suitable for children under 8 years due to small parts and essential pointed components. All models supplied unpainted.
© Copyright Games Workshop Ltd. 1998. All rights reserved.

CHAOS

HORRORS OF TZEENTCH



PINK HORROR 1
020104601



PINK HORROR 2
020104602



PINK HORROR 3
020104603



PINK HORROR 4
020104604



BLUE HORROR 1
020104701



BLUE HORROR 2
020104702



BLUE HORROR 3
020104703



BLUE HORROR 4
020104704



HORROR TAIL 1
020104605



HORROR TAIL 2
020104606

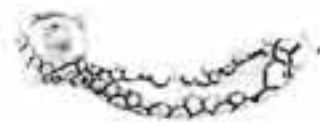

HORROR TAIL 3
020104607



HORROR TAIL 4
020104608

PINK HORROR 3 AND 4,
AND BLUE HORROR 2 AND 4,
ALL REQUIRE A HORROR TAIL



PINK HORROR



BLUE HORROR



CHAOS

PINK HORRORS COMMAND GROUP



PINK HORROR CHAMPION
020105201



PINK HORROR STANDARD BEARER
020105103



PINK HORROR DRUMMER
020105104



PINK HORROR CHAMPION TAIL
020105202



PINK HORROR STANDARD BEARER TAIL
020105101



PINK HORROR DRUMMER TAIL
020105102



PINK HORROR CHAMPION

A COMPLETE PINK HORROR
CHAMPION CONSISTS OF:
1 x PINK HORROR CHAMPION
1 x PINK HORROR CHAMPION TAIL



PINK HORROR STANDARD BEARER

A COMPLETE PINK HORROR
STANDARD BEARER CONSISTS OF:
1 x PINK HORROR STANDARD BEARER
1 x PINK HORROR STANDARD BEARER TAIL



PINK HORROR DRUMMER

A COMPLETE PINK HORROR
DRUMMER CONSISTS OF:
1 x PINK HORROR DRUMMER
1 x PINK HORROR DRUMMER TAIL



CITADEL
MINIATURES



CITADEL
MINIATURES

Designed by Trish Morrison

Not suitable for children under 8 years due to small parts and essential pointed components. All models supplied unpainted.
© Copyright Games Workshop Ltd, 1998. All rights reserved.

CHAOS

DAEMONETTE COMMAND GROUP



DAEMONETTE CHAMPION
020107401



DAEMONETTE HORN BLOWER
020107501



DAEMONETTE STANDARD BEARER
020107502

DAEMONETTES OF SLAANESH



DAEMONETTE 1
020101003



DAEMONETTE 2
020101004



DAEMONETTE 4
020101001



DAEMONETTE 3
020101002



DAEMONETTE 5
020101005



DAEMONETTE 6
020101006



DAEMONETTE 7
020101007



DAEMONETTE 8
020101008



CHAOS

DAEMONETTES ON STEEDS OF SLAANESH

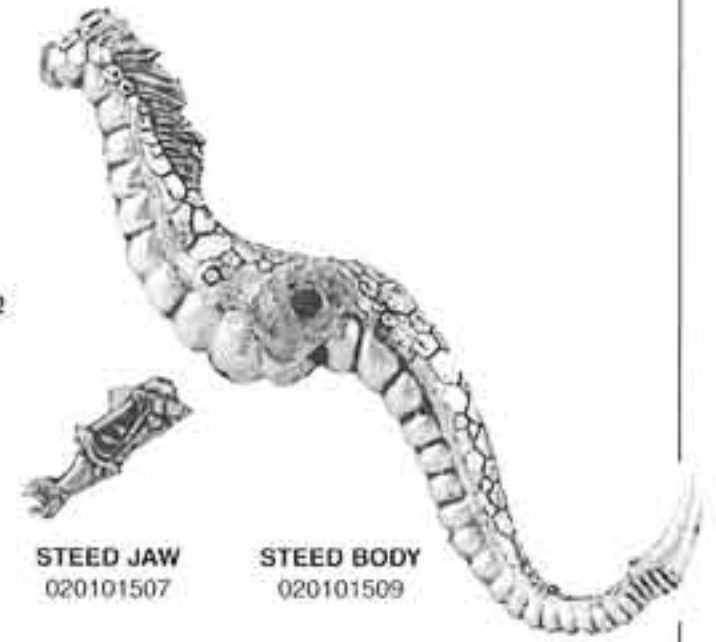
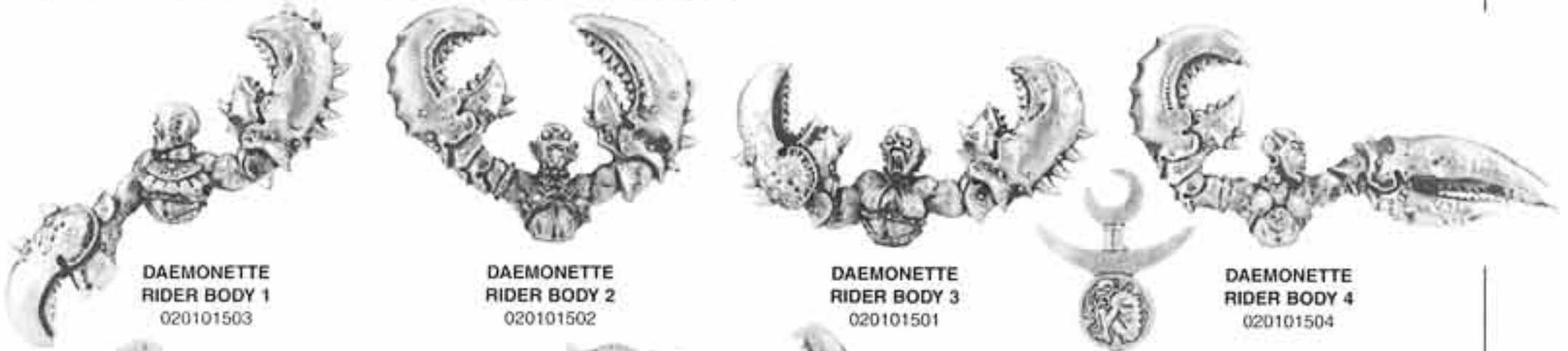

A COMPLETE DAEMONETTE MOUNTED ON A STEED OF SLAANESH CONSISTS OF:

- 1 x STEED BODY
- 1 x STEED RIGHT LEG
- 1 x STEED LEFT LEG
- 1 x STEED HEAD 2 OR STEED HEAD 1 AND STEED JAW
- 1 x DAEMONETTE RIDER BODY
- 1 x DAEMONETTE RIDER LEGS

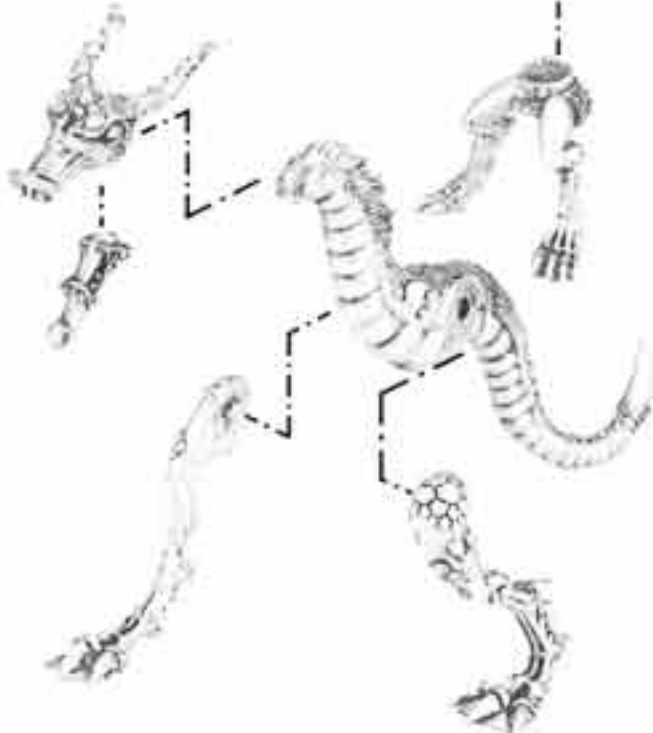

Designed by Trish Morrison and Aly Morrison

Not suitable for children under 8 years due to small parts and essential pointed components. All models supplied unpainted.
© Copyright Games Workshop Ltd. 1998. All rights reserved.

CHAOS

FIENDS OF SLAANESH



FIEND LEFT SIDE
020101901



FIEND RIGHT SIDE
020101902



FIEND HEAD 1
020101904



FIEND HEAD 2
020101903



FIEND RIGHT CLAW 1
020101905



FIEND RIGHT CLAW 2
020101906



FIEND LEFT CLAW 1
020101908



FIEND LEFT CLAW 2
020101907



FIEND OF SLAANESH

A COMPLETE FIEND OF
SLAANESH CONSISTS OF:
1 x FIEND RIGHT BODY
1 x FIEND LEFT BODY
1 x FIEND HEAD
1 x FIEND RIGHT CLAW
1 x FIEND LEFT CLAW

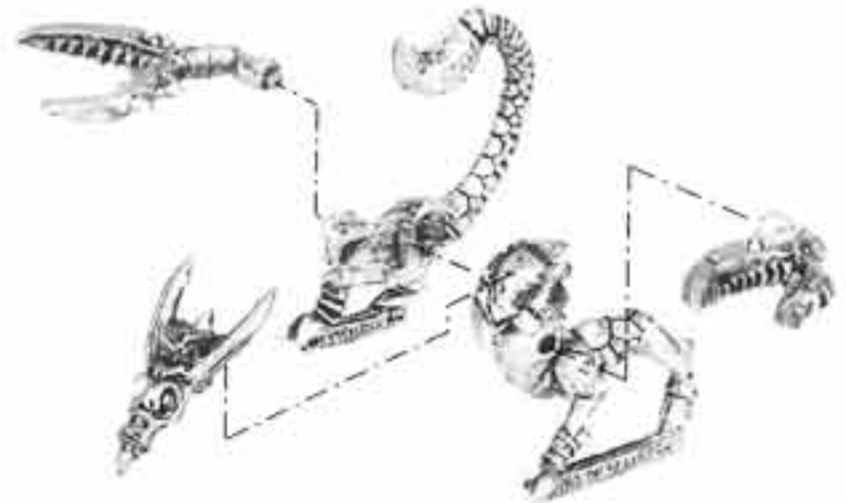

AEKOLD HELBRASS, CHAMPION OF TZEENTCH



AEKOLD HELBRASS
020101801



AEKOLD'S BANNER
020101802



THE COMPLETE AEKOLD
HELBRASS CONSISTS OF:
1 x AEKOLD HELBRASS
1 x AEKOLD'S BANNER



THE COMPLETED AEKOLD
HELBRASS



CHAOS

ARCHAON – LORD OF CHAOS UNDIVIDED



ARCHAON'S BODY
020107901



ARCHAON'S HELMET
020107903



ARCHAON'S SHIELD
021002201



W'SORAYCH'S HEAD
020107907



ARCHAON'S CLOAK
020107902



W'SORAYCH'S TAIL
020107908



ARCHAON - LORD OF CHAOS UNDIVIDED

A COMPLETE ARCHAON LORD OF CHAOS UNDIVIDED CONSISTS OF:
 1 x ARCHAON'S BODY
 1 x ARCHAON'S HELMET
 1 x ARCHAON'S SHIELD
 1 x ARCHAON'S CLOAK
 1 x W'SORAYCH'S HEAD
 1 x W'SORAYCH'S TAIL
 1 x W'SORAYCH'S LEFT SIDE
 1 x W'SORAYCH'S RIGHT SIDE



W'SORAYCH LEFT SIDE
020107905



W'SORAYCH RIGHT SIDE
020107906



CHAOS

ARBAAL THE UNDEFEATED



ARBAAL THE UNDEFEATED
BANNER TOP
020102905



ARBAAL THE UNDEFEATED
BODY
020102901



ARBAAL THE UNDEFEATED
BANNER POLE
020102904



ARBAAL THE UNDEFEATED
THRONE BACK
020102903



ARBAAL THE UNDEFEATED
LEGS
020102902



ARBAAL THE UNDEFEATED
FLESH HOUND BOTTOM JAW
020102907



ARBAAL THE UNDEFEATED
FLESH HOUND HEAD
020102906



ARBAAL THE UNDEFEATED
FLESH HOUND TAIL
020102910



ARBAAL THE UNDEFEATED
FLESH HOUND BODY
020102908



ARBAAL THE UNDEFEATED
FLESH HOUND COLLAR
020102909



CITADEL
MINIATURES



CITADEL
MINIATURES

CHAOS

ARBAAL THE UNDEFEATED



ARBAAL THE UNDEFEATED
FLESH HOUND LEFT FRONT LEG
020102913



ARBAAL THE UNDEFEATED
FLESH HOUND LEFT BACK LEG
020102914



ARBAAL THE UNDEFEATED
FLESH HOUND RIGHT FRONT LEG
020102911



ARBAAL THE UNDEFEATED
FLESH HOUND RIGHT BACK LEG
020102912

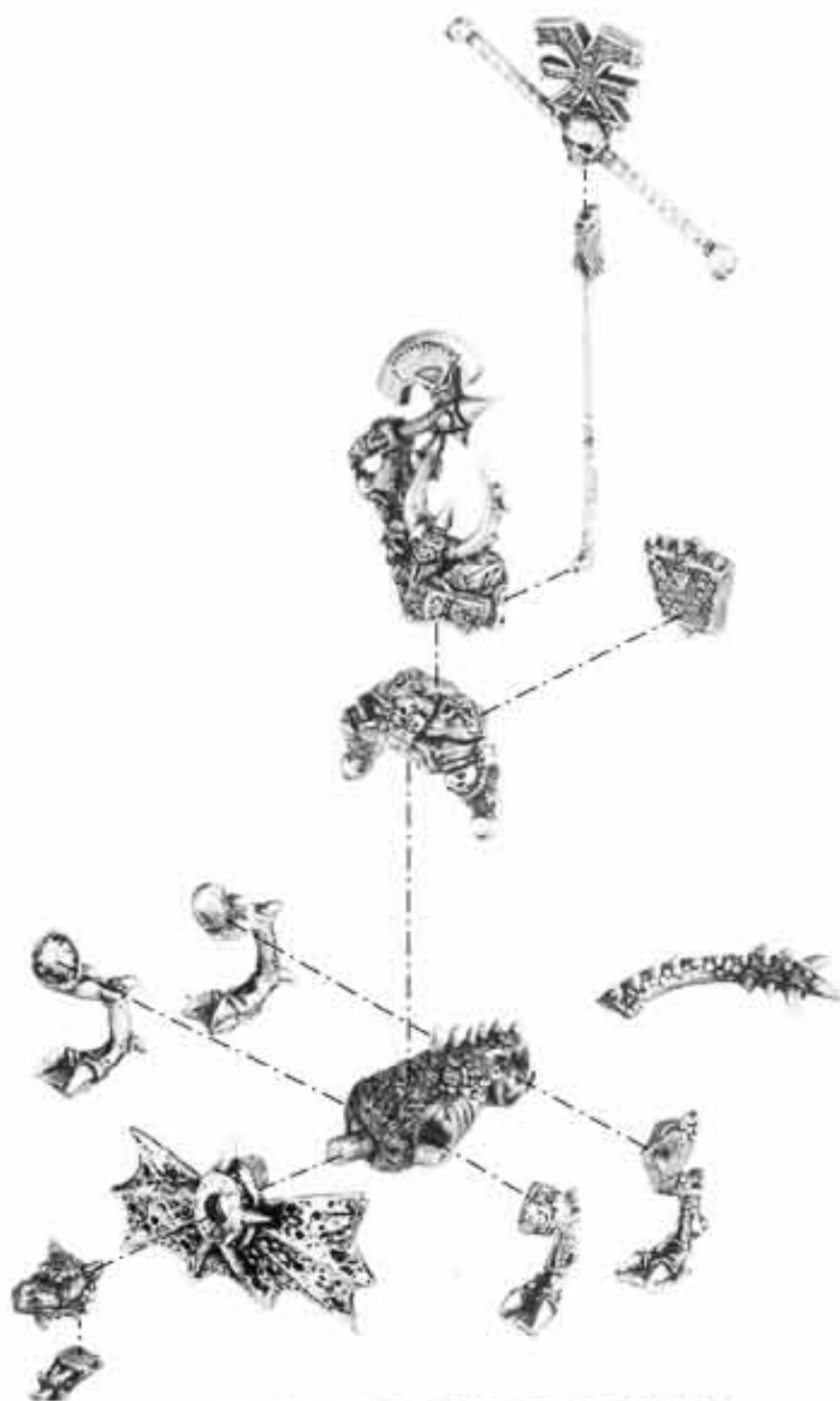

A COMPLETE ARBAAL THE UNDEFEATED CONSISTS OF:

- 1 x ARBAAL THE UNDEFEATED BODY
- 1 x ARBAAL THE UNDEFEATED LEGS
- 1 x ARBAAL THE UNDEFEATED THRONE BACK
- 1 x ARBAAL THE UNDEFEATED BANNER POLE
- 1 x ARBAAL THE UNDEFEATED BANNER TOP
- 1 x ARBAAL THE UNDEFEATED FLESH HOUND BOTTOM JAW
- 1 x ARBAAL THE UNDEFEATED FLESH HOUND HEAD
- 1 x ARBAAL THE UNDEFEATED FLESH HOUND BODY
- 1 x ARBAAL THE UNDEFEATED FLESH HOUND TAIL
- 1 x ARBAAL THE UNDEFEATED FLESH HOUND COLLAR
- 1 x ARBAAL THE UNDEFEATED FLESH HOUND LEFT FRONT LEG
- 1 x ARBAAL THE UNDEFEATED FLESH HOUND LEFT BACK LEG
- 1 x ARBAAL THE UNDEFEATED FLESH HOUND RIGHT FRONT LEG
- 1 x ARBAAL THE UNDEFEATED FLESH HOUND RIGHT BACK LEG



ARBAAL THE UNDEFEATED



Designed by Aly Morrison and Trish Morrison

Not suitable for children under 36 months due to small parts and essential pointed components. All models supplied unpainted.
© Copyright Games Workshop Ltd., 1997. All rights reserved.

CHAOS

EGRIMM VAN HORSTMANN,
DARK SORCERER OF CHAOS
ON BAUDROS, CHAOS DRAGON



EGRIMM BODY
020103014



EGRIMM LEGS
020103015



EGRIMM LANCE
020103016



CHAOS DRAGON
HORNS
020103007



CHAOS DRAGON
HEAD 1
020103005



CHAOS DRAGON
HEAD 2
020103006



CHAOS DRAGON
NECK 2
020103003

CHAOS DRAGON
NECK 1
020103004

CHAOS DRAGON
CHEST
021200111



CHAOS DRAGON
BELLY
021200112



CHAOS DRAGON
RIGHT ARM
020103010



CHAOS DRAGON
LEFT ARM
020103013



CHAOS DRAGON
RIGHT LEG
020103008



CHAOS DRAGON
LEFT LEG
020103000



CHAOS DRAGON
TAIL 1
020103002



CHAOS DRAGON
TAIL 2
020103001



CITADEL
MINIATURES



CITADEL
MINIATURES

CHAOS

EGRIMM VAN HORSTMANN, DARK SORCERER OF CHAOS ON BAUDROS, CHAOS DRAGON

A COMPLETED EGRIMM VAN HORSTMANN,
DARK SORCERER OF CHAOS
ON BAUDROS, CHAOS DRAGON
CONSISTS OF:

- 1 x EGRIMM BODY
- 1 x EGRIMM LEGS
- 1 x EGRIMM LANCE
- 1 x CHAOS DRAGON HEAD 1
- 1 x CHAOS DRAGON HEAD 2
- 1 x CHAOS DRAGON HORNS
- 1 x CHAOS DRAGON NECK 1
- 1 x CHAOS DRAGON NECK 2
- 1 x CHAOS DRAGON CHEST
- 1 x CHAOS DRAGON BELLY
- 1 x CHAOS DRAGON RIGHT ARM
- 1 x CHAOS DRAGON LEFT ARM
- 1 x CHAOS DRAGON RIGHT LEG
- 1 x CHAOS DRAGON LEFT LEG
- 1 x CHAOS DRAGON TAIL 1
- 1 x CHAOS DRAGON TAIL 2
- 1 x PLASTIC DRAGON WING 1
- 1 x PLASTIC DRAGON WING 2

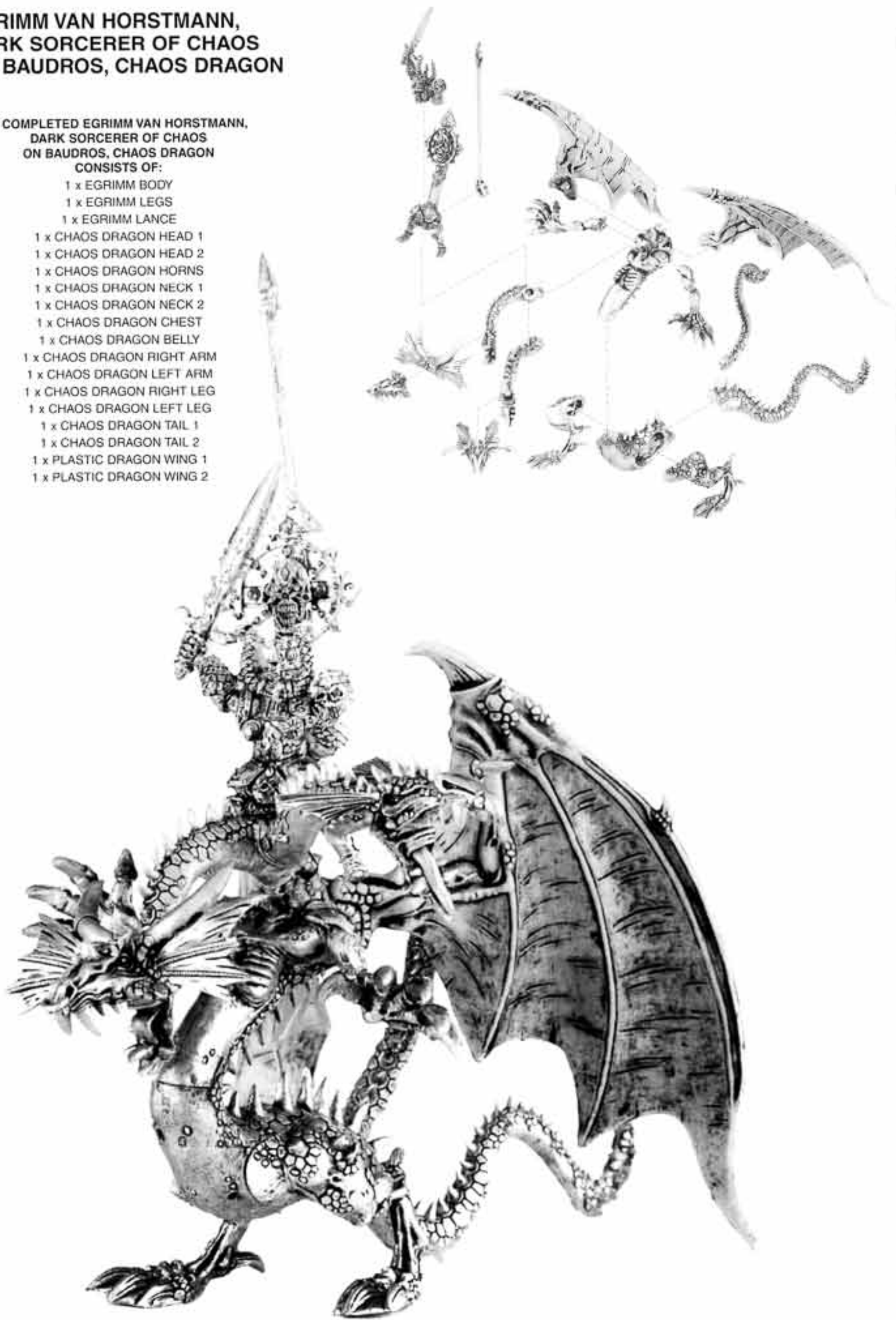

Chaos Dragon designed by Trish Morrison, Egrimm designed by Aly Morrison

Not suitable for children under 8 years due to small parts and essential pointed components. All models supplied unpainted.
© Copyright Games Workshop Ltd. 1998. All rights reserved.

CHAOS

AZAZEL – PRINCE OF DAMNATION



AZAZEL'S HEAD
020107801



AZAZEL'S TORSO
020107802



AZAZEL'S LEFT LEG
020107803



AZAZEL'S RIGHT LEG
020107804



AZAZEL'S SWORD ARM
020107805



AZAZEL'S CLAW ARM
020107806



AZAZEL'S TAIL
020107807



AZAZEL'S LEFT WING
020107808



AZAZEL'S RIGHT WING
020107809



A COMPLETE AZAZEL PRINCE OF DAMNATION CONSISTS OF:

- 1 x AZAZEL'S HEAD
- 1 x AZAZEL'S TORSO
- 1 x AZAZEL'S LEFT LEG
- 1 x AZAZEL'S RIGHT LEG
- 1 x AZAZEL'S SWORD ARM
- 1 x AZAZEL'S CLAW ARM
- 1 x AZAZEL'S TAIL
- 1 x AZAZEL'S LEFT WING
- 1 x AZAZEL'S RIGHT WING



A COMPLETED
AZAZEL – PRINCE OF DAMNATION

CHAOS

KHAZRAK THE ONE EYE AND RED MAW

A COMPLETE
KHAZRAK THE ONE EYE
CONSISTS OF:

- 1 x KHAZRAK THE ONE EYE'S BODY
- 1 x KHAZRAK THE ONE EYE'S HEAD
- 1 x KHAZRAK THE ONE EYE'S WHIP



KHAZRAK THE ONE EYE'S BODY
020108001



KHAZRAK THE ONE EYE'S HEAD
020108002



KHAZRAK THE ONE EYE'S WHIP
020108003



KHAZRAK THE ONE EYE

A COMPLETE
RED MAW
CONSISTS OF:

- 1 x RED MAW'S BODY
- 1 x RED MAW'S BACK LEG
- 1 x RED MAW'S FRONT LEG



RED MAW'S BODY
020108004



RED MAW'S BACK LEG
020108005



RED MAW'S FRONT LEG
020108006



RED MAW



Khazrak the one eye designed by Michael Perry. Red Maw designed by Trish Morrison

Not recommended for children under 8 years due to small parts and essential pointed components. All models supplied unpainted.
© Copyright Games Workshop Ltd. 1998. All rights reserved.



TADEL
MINIATURES

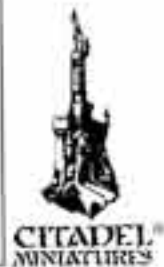

CITADEL
MINIATURES

CHAOS

GORTHOR, BEASTLORD CHARIOT



GORTHOR BEASTLORD BODY
020108401



GORTHOR BEASTLORD HEAD
020108402



GORTHOR BEASTLORD
SPEAR
020108403



GORTHOR BEASTLORD
TROPHY RACK
020108404



GORTHOR CHARIOT YOKE
02016705



GORTHOR CHARIOT HAFT
020106706



GORTHOR CHARIOTEER
020108407



GORTHOR CHARIOTEER WHIP ARM
020108408



GORTHOR CHARIOT SKULL
020108409



GORTHOR CHARIOT BASE
020108410

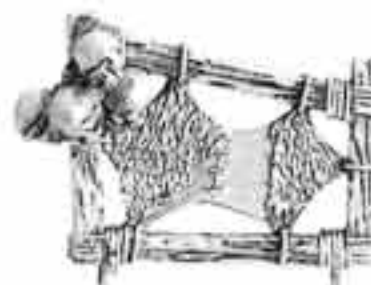

GORTHOR CHARIOT SIDE 1
020108411



GORTHOR CHARIOT
TUSKGOR HEAD 1
020108413



GORTHOR CHARIOT
TUSKGOR JAW
020108414



GORTHOR CHARIOT
TUSKGOR HEAD 2
020108415



GORTHOR CHARIOT
TUSKGOR HORNS
020108416



GORTHOR CHARIOT SIDE 2
020108412



CITADEL
MINIATURES



CITADEL
MINIATURES

Crew designed by Michael Perry. Chariot designed by Norman Swales. Tuskgors designed by Trish Morrison.

CHAOS

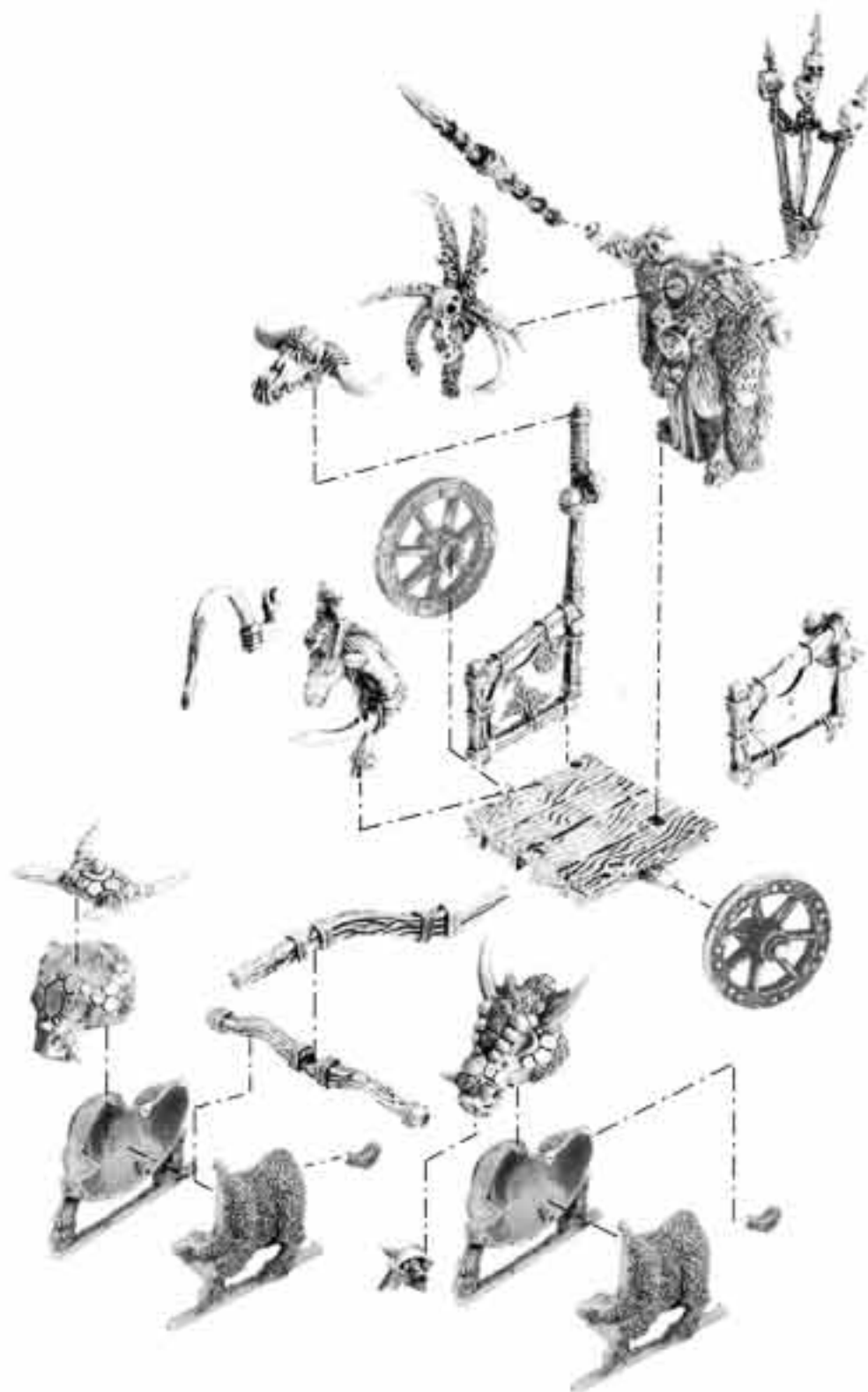

A COMPLETE GORTHOR, BEASTLORD CHARIOT CONSISTS OF:

- 1 x GORTHOR BEASTLORD BODY
- 1 x GORTHOR BEASTLORD HEAD
- 1 x GORTHOR BEASTLORD SPEAR
- 1 x GORTHOR BEASTLORD TROPHY BACK
- 1 x GORTHOR CHARIOT YOKE
- 1 x GORTHOR CHARIOT HAFT
- 1 x GORTHOR CHARIOTEER
- 1 x GORTHOR CHARIOTEER WHIP ARM
- 1 x GORTHOR CHARIOT SKULL
- 1 x GORTHOR CHARIOT BASE
- 1 x GORTHOR CHARIOT SIDE 1
- 1 x GORTHOR CHARIOT SIDE 2
- 1 x GORTHOR CHARIOT TUSKGOR HEAD 1
- 1 x GORTHOR CHARIOT TUSKGOR JAW
- 1 x GORTHOR CHARIOT TUSKGOR HEAD 2
- 1 x GORTHOR CHARIOT TUSKGOR HORNS
- 2 x COMPLETE PLASTIC BOARDS
- 2 x SOLID WHEELS



Crew designed by Michael Perry. Chariot designed by Norman Swales. Tuskhors designed by Trish Morrison.

Not suitable for children under 8 years due to small parts and essential pointed components. All models supplied unpainted.
© Copyright Games Workshop Ltd. 1998. All rights reserved.

DARK ELVES

HARPIES



HARPY BODY 1
029900801



HARPY BODY 2
029900802



HARPY WINGS
029900803



HARPY BODY 3
029900804



HARPY



A COMPLETE HARPY CONSISTS OF
1 x HARPY BODY
1 x HARPY WINGS

DARK ELF PLASTICS



DARK ELF PLASTIC WARRIOR SPRUE
102763



ELF PLASTIC SHIELD SPRUE
101635



PLASTIC DARK ELF WARRIOR

DARK ELVES

DARK ELF COMMAND GROUP



DARK ELF HORNBLOWER 1
021200403



DARK ELF HORNBLOWER 2
021200404



DARK ELF CHAMPION 1
021200501



DARK ELF CHAMPION 2
021200502



DARK ELF STANDARD BEARER 1
021200405

A COMPLETE DARK
ELF STANDARD
BEARER CONSISTS OF:
1 x DARK ELF
STANDARD BEARER
1 x DARK ELF
BANNER TOP



DARK ELF STANDARD BEARER



DARK ELF STANDARD BEARER 2
021200406



DARK ELF BANNER TOP 1
021200407



DARK ELF BANNER TOP 2
021200408



DARK ELF BANNER TOP 3
021200409



Designed by Aly Morrison and Colin Dixon

Not suitable for children under 36 months due to small parts and essential pointed components. All models supplied unpainted.
© Copyright Games Workshop Ltd., 1997. All rights reserved.

DARK ELVES

DARK ELF CROSSBOWMEN



DARK ELF CROSSBOWMAN 1
021200203



DARK ELF CROSSBOWMAN 2
021200204



DARK ELF CROSSBOWMAN 3
021200202



DARK ELF CROSSBOWMAN 4
021200205

A COMPLETE DARK
ELF CROSSBOWMAN
CONSISTS OF:
1 x DARK ELF
CROSSBOWMAN
1 x CROSSBOW



CROSSBOW
021200201



DARK ELF CROSSBOWMAN 5
021200209



DARK ELF CROSSBOWMAN 6
021200208



DARK ELF CROSSBOWMAN 7
021200206



DARK ELF CROSSBOWMAN 8
021200207



DARK ELF CROSSBOWMEN

DARK ELVES

DARK ELF SPEARMEN



SPEARMAN 1
021201504



SPEARMAN 2
021201502



SPEARMAN 3
021201501



SPEARMAN 4
021201503



SPEARMAN 5
021201506



SPEARMAN 6
021201508



SPEARMAN 7
021201507



SPEARMAN 8
021201505

ALL MINIATURES ARE SUPPLIED WITH THE APPROPRIATE PLASTIC SHIELDS



DARK ELF SPEARMEN



Designed by Aly Morrison and Colin Dixon

Not suitable for children under 8 years due to small parts and essential pointed components. All models supplied unpainted.
© Copyright Games Workshop Ltd. 1998. All rights reserved.

DARK ELVES

DARK ELF BLACK GUARD OF NAGGAROTH



BLACK GUARD 1
021200301



BLACK GUARD 2
021200302



BLACK GUARD 3
021200303



BLACK GUARD 4
021200304

DARK ELF CORSAIRS



DARK ELF CORSAIR 1
021200701



DARK ELF CORSAIR 2
021200702



DARK ELF CORSAIR 3
021200703



DARK ELF CORSAIR 4
021200704

DARK ELVES

COLD ONE KNIGHTS



**COLD ONE KNIGHT
TORSO 1**
021200803



**COLD ONE KNIGHT
TORSO 2**
021200804



**COLD ONE KNIGHT
CHAMPION**
021201001



**COLD ONE KNIGHT
STANDARD TOP**
021200804



**COLD ONE KNIGHT
STANDARD BEARER**
021200901



**COLD ONE KNIGHT
LEGS**
021200805



**COLD ONE KNIGHT LEGS
WITH REPEATING CROSSBOW**
021200903



COLD ONE HEAD 1
021200810



COLD ONE HEAD 2
021200813



COLD ONE HEAD 4
021200812



COLD ONE TAIL 2
021200817



COLD ONE TAIL 3
021200815



COLD ONE TAIL 4
021200814



COLD ONE KNIGHT LANCE
021200802

COLD ONE A



COLD ONE LEFT SIDE A
021200807



COLD ONE RIGHT SIDE A
021200806

COLD ONE B



COLD ONE LEFT SIDE B
021200809



COLD ONE RIGHT SIDE B
021200808

COLD ONE SIDES A AND B ARE NOT INTERCHANGEABLE

A COMPLETE DARK ELF COLD ONE KNIGHT CONSISTS OF:

- 1 x COLD ONE KNIGHT TORSO
 - 1 x COLD ONE KNIGHT LEGS
 - 1 x COLD ONE KNIGHT LANCE, EXCEPT FOR
CHAMPION AND STANDARD BEARER
 - 1 x COLD ONE RIGHT HAND SIDE
 - 1 x COLD ONE LEFT HAND SIDE
 - 1 x COLD ONE HEAD
 - 1 x COLD ONE TAIL
 - 1 x PLASTIC ELF SHIELD
- THE STANDARD BEARER ALSO INCLUDES:
1x COLD ONE KNIGHT STANDARD TOP



**DARK ELF COLD
ONE KNIGHT**



CITADEL
MINIATURES



CITADEL
MINIATURES

Designed by Trish morrison, Aly Morrison and Colin Dixon

Not suitable for children under 36 months due to small parts and essential pointed components. All models supplied unpainted.
© Copyright Games Workshop Ltd., 1997. All rights reserved.

DARK ELVES

DARK ELF GENERAL MOUNTED ON ARMoured COLD ONE



**DARK ELF GENERAL'S
TORSO**
021201201



**DARK ELF GENERAL'S
LEGS**
021201202



**ARMoured COLD ONE
HEAD**
021201203



COLD ONE TAIL 3
021200815



COLD ONE TAIL 4
021200814



COLD ONE TAIL 2
021200817



**DARK ELF GENERAL'S
LANCE**
021201204



**ARMoured COLD ONE
RIGHT BODY**
021201207



**ARMoured COLD ONE
LEFT BODY**
021201206

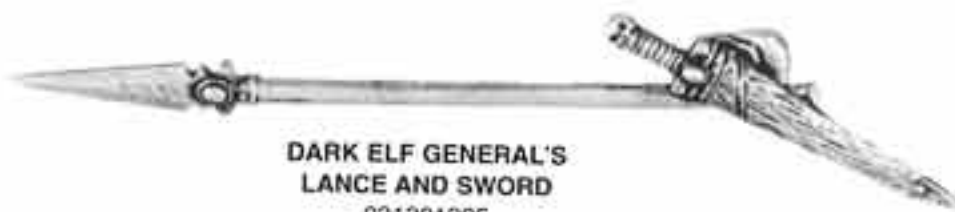

**DARK ELF GENERAL'S
LANCE AND SWORD**
021201205

**A COMPLETED DARK ELF GENERAL
MOUNTED ON ARMoured COLD ONE
CONSISTS OF:**

- 1 x DARK ELF GENERAL'S TORSO
- 1 x DARK ELF GENERAL'S LEGS
- 1 x DARK ELF GENERAL'S LANCE
- 1 x DARK ELF GENERAL'S LANCE AND SWORD
- 1 x ARMoured COLD ONE HEAD
- 1 x ARMoured COLD ONE RIGHT BODY
- 1 x ARMoured COLD ONE LEFT BODY
- 1 x COLD ONE TAIL
- 1 x PLASTIC ELF SHIELD



DARK ELF GENERAL MOUNTED ON ARMoured COLD ONE

DARK ELVES

DARK RIDER COMMAND



DARK RIDER CHAMPION
021201801

A COMPLETE
DARK RIDER CHAMPION
CONSISTS OF:
1 x DARK RIDER
CHAMPION
1 x DARK RIDER
CROSSBOW TOP
1 x DARK RIDER
CROSSBOW HANDLE
1 x PLASTIC ELVEN
STEED



DARK RIDER CROSSBOW TOP
021201705

A COMPLETE
DARK RIDER
STANDARD BEARER
CONSISTS OF:
1 x DARK RIDER
STANDARD BEARER
1 x DARK RIDER
CROSSBOW TOP
1 x DARK RIDER
CROSSBOW HANDLE
1 x PLASTIC ELVEN
STEED



DARK RIDER CROSSBOW HANDLE
021201906



DARK RIDER STANDARD BEARER
021201901

DARK RIDERS



DARK RIDER 1
021201701



DARK RIDER 2
021201702



DARK RIDER 3
021201703



DARK RIDER 4
021201704



A COMPLETE
DARK RIDER
CONSISTS OF:
1 x DARK RIDER
1 x DARK RIDER
CROSSBOW TOP
1 x DARK RIDER
CROSSBOW HANDLE
1 x PLASTIC ELVEN
STEED



DARK RIDERS

DARK ELVES

DARK ELF REPEATER BOLT THROWER



REPEATER BOLT THROWER
CREWMAN 1
021201101



REPEATER BOLT THROWER
CREWMAN 2
021201102



REPEATER BOLT THROWER
LEVER
021201106



REPEATER BOLT THROWER
STAND
021201107

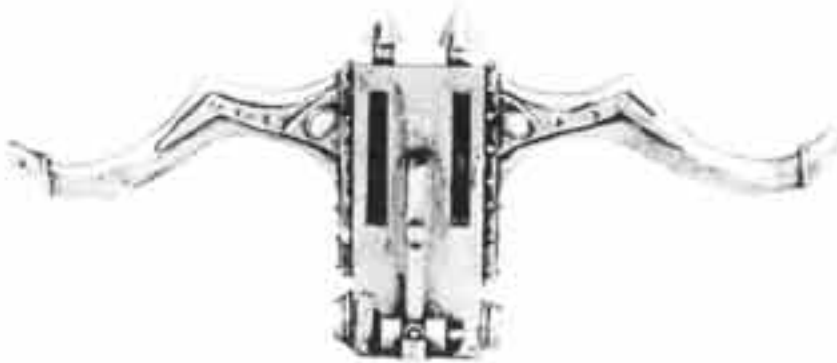

REPEATER BOLT THROWER
BOW
021201103



REPEATER BOLT THROWER
LEFT MAGAZINE
021201105



REPEATER BOLT THROWER
RIGHT MAGAZINE
021201104

A COMPLETED
DARK ELF REPEATER BOLT THROWER
CONSISTS OF:
1 x REPEATER BOLT THROWER CREWMAN 1
1 x REPEATER BOLT THROWER CREWMAN 2
1 x REPEATER BOLT THROWER LEVER
1 x REPEATER BOLT THROWER STAND
1 x REPEATER BOLT THROWER BOW
1 x REPEATER BOLT THROWER LEFT MAGAZINE
1 x REPEATER BOLT THROWER RIGHT MAGAZINE

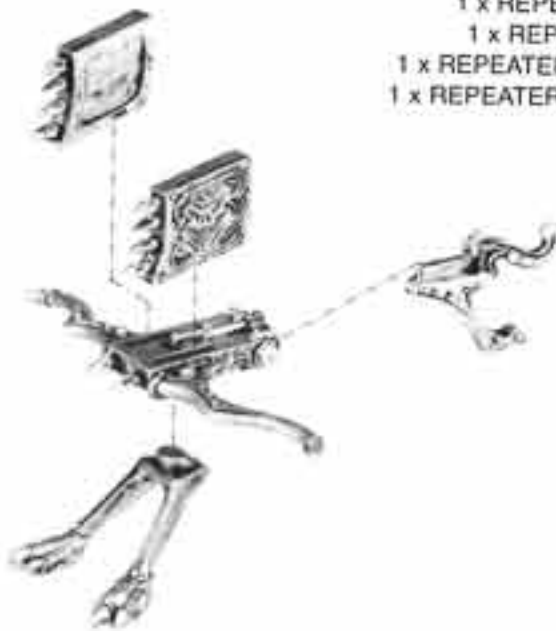

DARK ELF REPEATER BOLT THROWER



DARK ELVES

DARK ELF ASSASSINS



DARK ELF ASSASSIN 1
021201401



DARK ELF ASSASSIN 2
021201402

DARK ELF SORCERESS



DARK ELF SORCERESS
021202001



ADEL
MINIATURES



CITADEL
MINIATURES

Assassins by Aly Morrison and Sorceress by Chris Fitzpatrick

Not recommended for children under 8 years due to small parts and essential pointed components. All models supplied unpainted.
© Copyright Games Workshop Ltd. 1998. All rights reserved.

DARK ELVES

WITCH ELVES



WITCH ELF 1
021200604



WITCH ELF 2
021200603



WITCH ELF 3
021200606



WITCH ELF 4
021200605



WITCH ELF 5
021200602



WITCH ELF 6
021200607



WITCH ELF 7
021200601



WITCH ELF 8
021200609



WITCH ELF 9
021200608

DARK ELVES

CAULDRON OF BLOOD

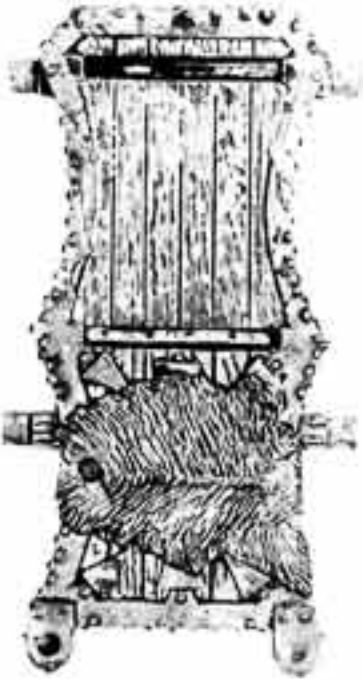

CAULDRON OF BLOOD CHASSIS
021201604



CAULDRON OF BLOOD HAG QUEEN
021201601

- THE CAULDRON OF BLOOD
CONSISTS OF:
- 1 x HAG QUEEN
 - 1 x GUARDIAN 1
 - 1 x GUARDIAN 2
 - 1 x CHASSIS
 - 2 x FRONT BLADES
 - 2 x BANNER POLES
 - 1 x BURNING COALS
 - 1 x CAULDRON TOP
 - 1 x CAULDRON BOTTOM
 - 2 x CAULDRON RESTS
 - 2 x SCYTHE BASES
 - 2 x SCYTHES
 - 4 x PLASTIC SPOKED WHEELS
 - 2 x PENNANTS



CAULDRON OF BLOOD GUARDIAN 1
021201602



CAULDRON OF BLOOD GUARDIAN 2
021201603



CAULDRON OF BLOOD BURNING COALS
021201607



CAULDRON OF BLOOD CAULDRON BOTTOM
021201608



CAULDRON OF BLOOD CAULDRON TOP
021201609



CAULDRON OF BLOOD BANNER POLE
021201606



CAULDRON OF BLOOD SCYTHE BASE
021201611



CAULDRON OF BLOOD SCYTHE
021201612



CAULDRON OF BLOOD CAULDRON REST
021201610



CAULDRON OF BLOOD FRONT BLADE
021201605



PLASTIC SPOKED WHEELS
100557

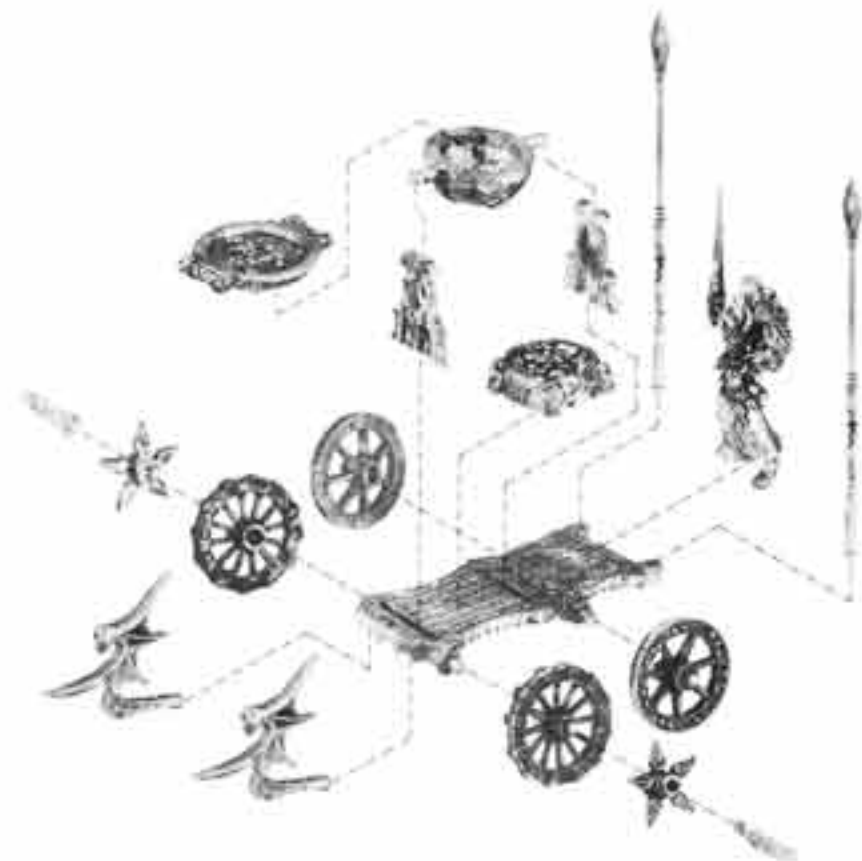

Designed by Aly Morrison and Norman Swales

Not suitable for children under 36 months due to small parts and essential pointed components. All models supplied unpainted.
© Copyright Games Workshop Ltd., 1997. All rights reserved.

DARK ELVES

THE BEAST LORD RAKARTH DARK ELF DRAGON RIDER



BEAST LORD RAKARTH'S TORSO
021200101



BEAST LORD RAKARTH'S LEGS
021200102



BEAST LORD RAKARTH'S SHIELD
021200104



BEAST LORD RAKARTH'S WHIP OF AGONY
021200103



BLACK DRAGON'S HORNS
021200108



BLACK DRAGON'S NECK
021200113



BLACK DRAGON'S HEAD
021200107



BLACK DRAGON'S BELLY
021200112



BLACK DRAGON'S TAIL
021200105



BLACK DRAGON'S LEFT ARM
021200110



BLACK DRAGON'S RIGHT ARM
021200109



BLACK DRAGON'S TAIL END
021200106



BLACK DRAGON'S RIGHT LEG
021200114



BLACK DRAGON'S LEFT LEG
021200115



BLACK DRAGON'S CHEST
021200111



DARK ELVES

BEAST LORD RAKARTH DARK ELF DRAGON RIDER

THE COMPLETE BEAST LORD RAKARTH AND HIS BLACK DRAGON CONSISTS OF:

- 1 x BEAST LORD RAKARTH'S TORSO
- 1 x BEAST LORD RAKARTH'S LEGS
- 1 x BEAST LORD RAKARTH'S WHIP OF AGONY
- 1 x BEAST LORD RAKARTH'S SHIELD
- 1 x BLACK DRAGON'S HORNS
- 1 x BLACK DRAGON'S HEAD
- 1 x BLACK DRAGON'S NECK
- 1 x BLACK DRAGON'S CHEST
- 1 x BLACK DRAGON'S BELLY
- 1 x BLACK DRAGON'S TAIL
- 1 x BLACK DRAGON'S TAIL END
- 1 x BLACK DRAGON'S RIGHT LEG
- 1 x BLACK DRAGON'S LEFT LEG
- 1 x BLACK DRAGON'S LEFT ARM
- 1 x BLACK DRAGON'S RIGHT ARM
- 1 x LEFT PLASTIC WING 102797
- 1 x RIGHT PLASTIC WING 102796
- 1 x ADHESIVE COLOUR BANNER



BEAST LORD RAKARTH
DARK ELF DRAGON RIDER

DOGS OF WAR

ALCATANI FELLOWSHIP



ALCATANI PIKEMAN 1
021400015



ALCATANI PIKEMAN 2
021400107



ALCATANI PIKEMAN 3
021400108



ALCATANI PIKEMAN 4
021400109



ALCATANI PIKEMAN 5
021400110



ALCATANI PIKEMAN 6
021400111



ALCATANI PIKEMAN 7
021400112



ALCATANI PIKEMAN 8
021400113

ALCATANI FELLOWSHIP COMMAND



ALCATANI FELLOWSHIP
MUSICIAN
021400104



ALCATANI FELLOWSHIP
STANDARD BEARER
021400106

A COMPLETE RODERIGO DELMONTE CONSISTS OF:
1 x RODERIGO DELMONTE BODY
1 x DAGGER ARM
1 x WARHAMMER ARM



WARHAMMER ARM
021400102



DAGGER ARM
021400103



RODERIGO DELMONTE BODY
021400101



COMPLETED
RODERIGO DELMONTE



DOGS OF WAR

ALCATANI FELLOWSHIP



ALCATANI PIKEMAN 9
021400114



ALCATANI PIKEMAN 10
021401615



ALCATANI PIKEMAN 11
021401616



ALCATANI PIKEMAN 12
021401617



ALCATANI PIKEMAN 13
021401618



ALCATANI PIKEMAN 14
021401619



ALCATANI PIKEMAN 15
021401620



ALCATANI PIKEMAN 16
021401621



ALCATANI PIKEMAN 17
021401622



ALCATANI PIKEMAN 18
021401623



TADEL
SIGNATURES



CITADEL
MINIATURES

DOGS OF WAR

ALCATANI FELLOWSHIP



ALCATANI PIKEMAN 19
021401624



ALCATANI PIKEMAN 20
021401625



ALCATANI PIKEMAN 21
021401626



ALCATANI PIKEMAN 22
021401627



ALCATANI PIKEMAN 23
021401628



DOGS OF WAR

LEOPOLD'S LEOPARD COMPANY



SECOND RANK
PIKEMAN 1
021401105

SECOND RANK
PIKEMAN 2
021401106

FIRST RANK
PIKEMAN 1
021401107

FIRST RANK
PIKEMAN 2
021401108



LEOPARD COMPANY
PIKEMAN 1
021401101

LEOPARD COMPANY
PIKEMAN 2
021401102

LEOPARD COMPANY
PIKEMAN 3
021402403

LEOPARD COMPANY
PIKEMAN 4
021401104



LEOPOLDO DI LUCCI
021401109



LEOPOLDO'S SWORD ARM
021401110



LEOPARD COMPANY
DRUMMER
021401111



LEOPARD COMPANY
STANDARD
021401112



Designed by Alan Perry

DOGS OF WAR

PIRAZZO'S LOST LEGION



PIRAZZO'S ARM
021403113

A COMPLETE
PIRAZZO
CONSISTS OF:
1 x PIRAZZO
1 x PIRAZZO'S ARM



PIRAZZO
021403112



PIRAZZO'S DRUMMER
021403114



STANDARD BEARER
021403111



LEGIONNAIRE 1
021403101



LEGIONNAIRE 2
021403102



LEGIONNAIRE 3
021403103



LEGIONNAIRE 4
021403104



CROSSBOW
021403110



LEGIONNAIRE 5
021403105



LEGIONNAIRE 6
021403106



LEGIONNAIRE 7
021403107



LEGIONNAIRE 8
021403108



PIKE
021403109

A COMPLETE
PIRAZZO'S LOST LEGIONNAIRE
CONSISTS OF:
1 x LEGIONNAIRE
AND EITHER
1 x PIKE
OR 1 x CROSSBOW



DOGS OF WAR

RICCO'S REPUBLICAN GUARD



A COMPLETE
RICCO
CONSISTS OF:
1 x RICCO
1 x RICCO'S ARM



A COMPLETE
RICCO'S REPUBLICAN GUARD CONSISTS
OF:
1 x REPUBLICAN
1 x PIKE



Designed by Alan Perry

DOGS OF WAR

MARKSMEN OF MIRAGLIANO



MARKSMAN 1
021400205



MARKSMAN 2
021400206



MARKSMAN 3
0214002807



MARKSMAN 4
021401809



MARKSMAN 5
021401810



MARKSMAN 6
021401811



MARKSMAN 7
021401812



MARKSMAN 8
021401813



MARKSMAN 9
021401814



MARKSMAN 10
021401815



MARKSMAN 11
021401816



MARKSMAN 12
021401817



CROSSBOW
021400208



EXAMPLE OF
COMPLETED MARKSMAN

A COMPLETE
MARKSMAN OF MIRAGLIANO
CONSISTS OF:
1 x MARKSMAN
1 x CROSSBOW



MAXIMILLIAN DAMARK
021400201



MAXIMILLIAN'S RIGHT ARM
021400202



DRUMMER
021400203



STANDARD BEARER
021400204

A COMPLETE
MAXIMILLIAN DAMARK
CONSISTS OF:
1 x MAXIMILLIAN DAMARK
1 x MAXIMILLIAN RIGHT ARM



COMPLETED
MAXIMILLIAN DAMARK



CITADEL
MINIATURES



CITADEL
MINIATURES

DOGS OF WAR

BRAGANZA'S BESIEGERS



BESIEGER 1
021401308



BESIEGER 2
021401309



CROSSBOW
021401306



PAVISE
021401307



BESIEGER 3
021401310



BESIEGER 4
021401311



LUCA BRAGANZA
021401301



BRAGANZA'S CROSSBOW
021401302



STANDARD BEARER
021401303



MUSICIAN
021401304



BUGLE
021401305



Designed by Alan Perry

DOGS OF WAR

LONG DRONG SLAYER'S DWARF PIRATES



LONG DRONG SLAYER
021401007



MUSICIAN
021401009



STANDARD BEARER
021401008



BANNER TOP
021401006



PIRATE 1
021401001



PIRATE 2
021401002



PIRATE 3
021401003



PIRATE 4
021401004



DWARF PISTOLS
021401005



DOGS OF WAR

BEORG BEARSTRUCK AND THE BEARMEN OF URSLO



BEORG BEARSTRUCK
021400706



BEORG'S ARM
021400707



BEARMAN MUSICIAN
021400708



BEARMAN STANDARD
021400709

A COMPLETE BEORG BEARSTRUCK CONSISTS OF:
1 X BEORG BEARSTRUCK
1 X BEORG'S ARM



BEORG BEARSTRUCK



BEARMAN 1
021400701



BEARMAN 2
021400702



BEARMAN SHIELD
021400705

A COMPLETE BEARMAN CONSISTS OF:
1 x BEARMAN
1 x BEARMAN SHIELD



BEARMAN 3
021400703



BEARMAN 4
021400704



Designed by Dave Andrews and Trish Morrison

Not recommended for children under 8 years due to small parts and essential pointed components. All models supplied unpainted.
© Copyright Games Workshop Ltd. 1998. All rights reserved.

DOGS OF WAR

VESPERO'S VENDETTA



DUELLIST 1
021403406



DUELLIST 2
021403403



DUELLIST 3
021403404



DUELLIST 4
021403405



VESPERO
021403401



VESPERO'S ARM
021403402



LORENZO LUPO



LORENZO LUPO
021403001

A COMPLETE LORENZO LUPO
CONSISTS OF:
1 x LORENZO LUPO
1 x LORENZO'S SHIELD



LORENZO'S SHIELD
021403002

DOGS OF WAR

AL MUKHTAR'S DESERT DOGS



DESERT DOG 1
021400606



DESERT DOG 2
021402709



DESERT DOG SWORD ARM
021400607



DESERT DOG SWORD ARM 2
021402710



DESERT DOG SHIELD
021400608



AL MUKHTAR
021400601



DESERT DOG TRUMPETER
021400604



DESERT DOG TRUMPET
021400605



SHEIKH SHUFTI
021400603



BLIND IBN THE BEGGAR BOY
021400602



AL MUKHTAR



DESERT DOG



Designed by Michael Perry

Not recommended for children under 8 years due to small parts and essential pointed components. All models supplied unpainted.
© Copyright Games Workshop Ltd. 1998. All rights reserved.

DOGS OF WAR

VOLAND'S VENATORS



VOLAND
021403301



VENATOR MUSICIAN
021403301



TRUMPET
021403303



VENATOR STANDARD BEARER
021403309



VENATOR STANDARD
021403304



VENATOR 1
021403307



VENATOR 2
021403308



VENATOR 3
021403610



VENATOR 4
021403611



VENATOR 5
021403612



VENATOR 6
021403613



VENATOR SHIELD
021403306



VENATOR LANCE
021403305



VOLAND

**A COMPLETE VOLAND'S VENATOR
CONSISTS OF:**
1 x VOLAND'S VENATOR
1 x VENATOR SHIELD
1 x VENATOR LANCE
1 x PLASTIC ARMoured WARHORSE



DOGS OF WAR

THE BIRDMEN OF CATRAZZA



BIRDMAN 1
021401401



BIRDMAN 2
021401402



DADDALLO
021401403



CROSSBOW
021400208

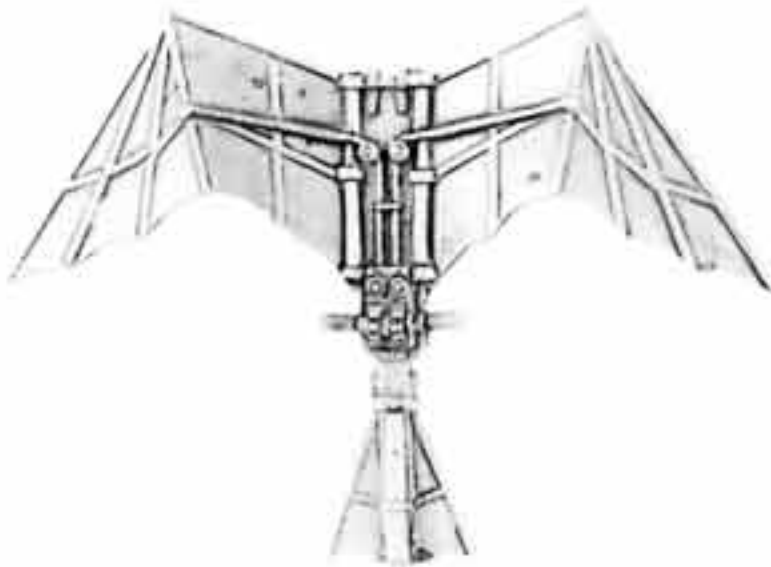

BIRDMAN WINGS
021401404



PEDALS
0214001405

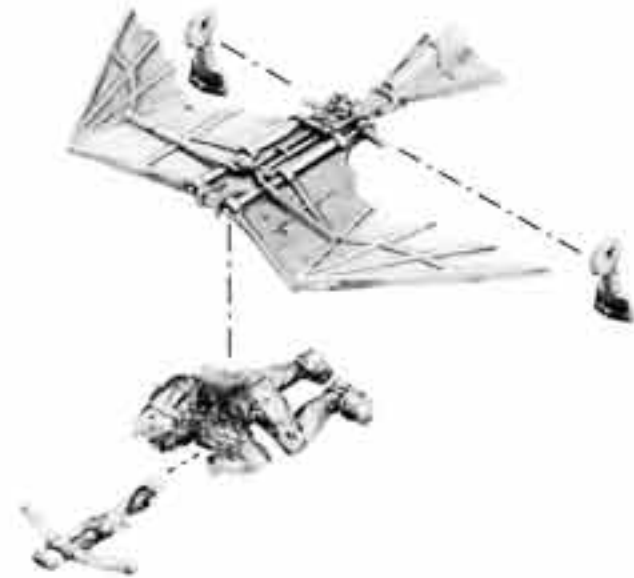

A COMPLETE BIRDMAN OF CATRAZZA CONSISTS OF:

- 1 x BIRDMAN
- 1 x BIRDMAN WINGS
- 1 x PEDALS
- 1 x CROSSBOW
- 1 x FLYING BASE

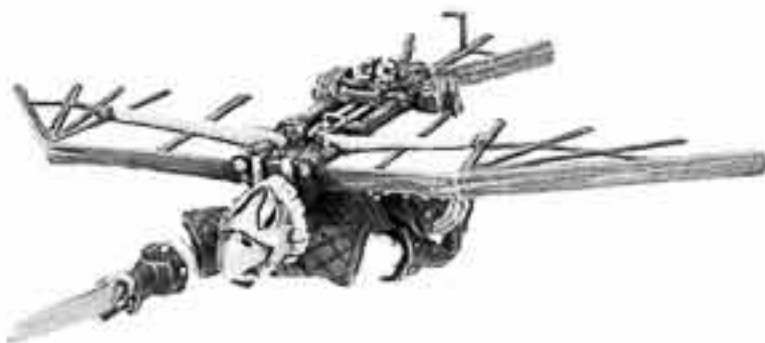

DADDALLO

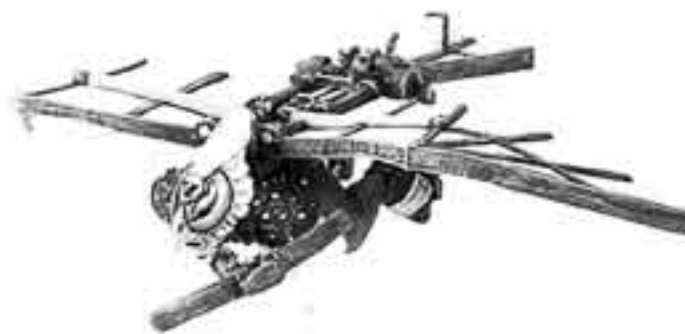

BIRDMAN OF CATRAZZA



Designed by Dave Andrews and Norman Swales

Not recommended for children under 8 years due to small parts and essential pointed components. All models supplied unpainted.
© Copyright Games Workshop Ltd. 1998. All rights reserved.

DOGS OF WAR

LUCREZZIA BELLADONNA

A COMPLETE
LUCREZZIA BELLADONNA
CONSISTS OF:
1 x LUCREZZIA BELLADONNA
1 x LUCREZZIA'S HORSE HEAD
1 x PLASTIC BRETONNIAN HORSE



LUCREZZIA BELLADONNA
021402001



LUCREZZIA'S HORSE HEAD
021402002



DOGS OF WAR MERCENARY GENERAL

A COMPLETE
MOUNTED MERCENARY GENERAL
CONSISTS OF:
1 x MERCENARY GENERAL
1 x GENERAL'S HORSE HEAD
1 x PLASTIC ARMoured HORSE



GENERAL'S HORSE HEAD
021400302



MERCENARY GENERAL
021400301



BORGIO THE BESIEGER

A COMPLETE
BORGIO THE BESIEGER
CONSISTS OF:
1 x BORGIO THE BESIEGER
1 x BORGIO'S SHIELD
1 x PLASTIC ARMoured HORSE



BORGIO THE BESIEGER
021402901



BORGIO'S SHIELD
021402902



CITADEL
MINIATURES



CITADEL
MINIATURES

DOGS OF WAR

MYDAS THE MEAN



MYDAS THE MEAN
021402201



MYDAS' MACE
021402202



MYDAS' SHIELD
021402203



SHEIKH YADOSH
021402204



MULE'S TAIL
021402206



MULE'S HEAD
021402205

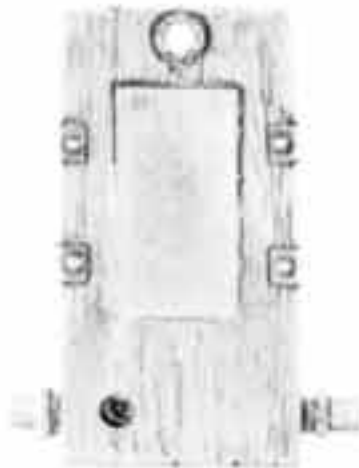

CHASSIS
021402207



PULLEY
021402210



MONEY CHEST LID
021402209



MONEY CHEST
021402208



YOKE
021400513

A COMPLETE MYDAS THE MEAN CONSISTS OF:

- 1 x MYDAS THE MEAN
- 1 x MYDAS' MACE
- 1 x MYDAS' SHIELD
- 1 x SHEIKH YADOSH
- 1 x MULE'S TAIL
- 1 x MULE'S HEAD
- 1 x YOKE
- 1 x CHASSIS
- 1 x PULLEY
- 1 x MONEY CHEST LID
- 1 x MONEY CHEST
- 1 x PLASTIC HORSE SPRUE
- 4 x PLASTIC SPOKED WHEELS



PLASTIC
SPOKED WHEEL
100557



COMPLETE MYDAS THE MEAN

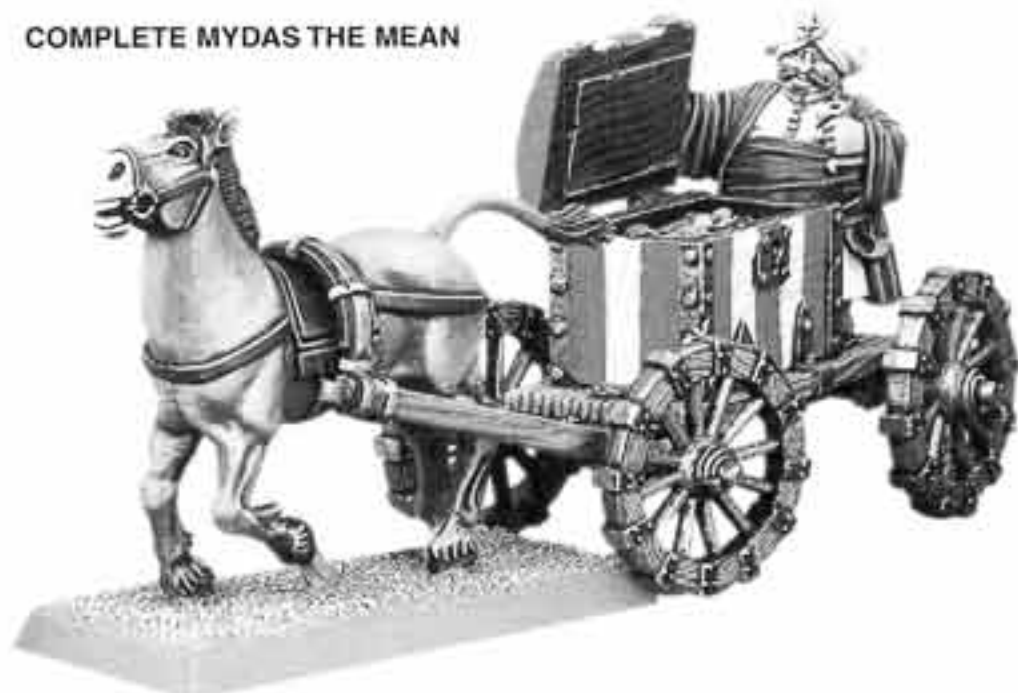

Designed by Michael Perry. Wagon designed by Norman Swales

Not recommended for children under 8 years due to small parts and essential pointed components. All models supplied unpainted.
© Copyright Games Workshop Ltd. 1998. All rights reserved.

DOGS OF WAR

BRONZINO'S GALLOPER GUNS



HORSE'S HEAD
021400511



CREW 1
021400516



CREW 2
021400505



CREW 3
021400515



CREW 4
021400506



CREW 4 ARM
021400507



GUN CARRIAGE
021400508



CANNON BARREL
021400510



RIDER 1
021401504



RIDER 2
021401514



LIMBER CHASSIS
021400509



YOKE
021400513



AMMO CASE
021400512

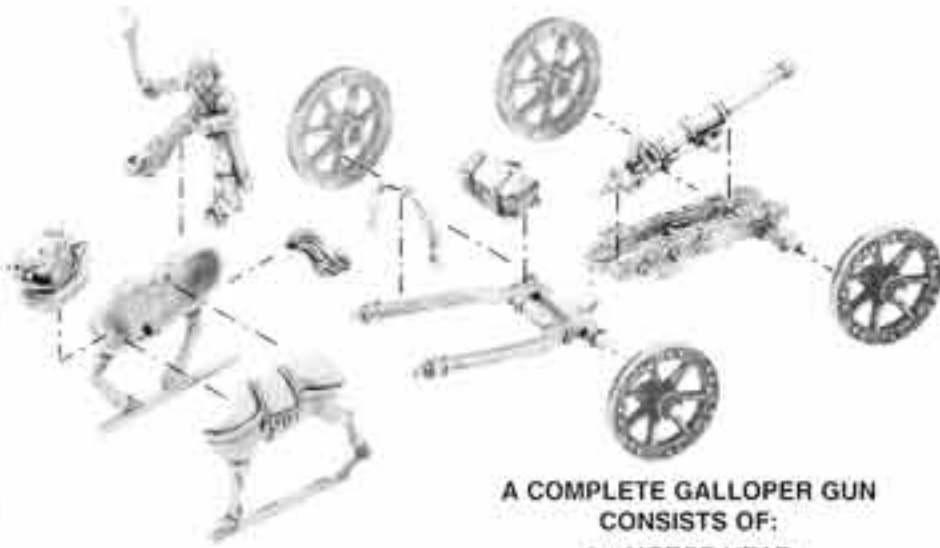

**A COMPLETE GALLOPER GUN
CONSISTS OF:**

- 1 x HORSE HEAD
- 1 x PLASTIC HORSE
- 1 x PLASTIC WHEEL SPRUE
- 1 x AMMO CASE
- 1 x YOKE
- 1 x GUN CARRIAGE
- 1 x CANNON BARREL
- 1 x LIMBER CHASSIS
- 1 x RIDER
- 2 x CREW



GALLOPER GUN COMPLETE

BRONZINO



BRONZINO'S ARM
021400502



BRONZINO'S HORSE'S HEAD
021400503



BRONZINO
021400501

**A COMPLETE BRONZINO
CONSISTS OF:**

- 1 x HORSE HEAD
- 1 x PLASTIC HORSE
- 1 x BRONZINO BODY
- 1 x BRONZINO ARM



BRONZINO COMPLETE



DOGS OF WAR

GOLGFAG'S OGRES



OGRE BODY 1
021401214



OGRE RIGHT ARM 1
021401217



OGRE LEFT ARM 1
021401216



HEAD 1
021401215



OGRE BODY 2
021401218



OGRE RIGHT ARM 2
021401220



OGRE LEFT ARM 2
021401212



HEAD 2
021401221



STANDARD BEARER BODY
021401205



STANDARD BEARER'S LEFT ARM
021401207



STANDARD BEARER'S HEAD
021401206



STANDARD ARM
021401208

Please note that these components are not interchangeable. For example Ogre left arm 1 will not fit Ogre body 2, Ogre body 1 will not fit Golgfag's head, and so on.



CITADEL
MINIATURES



CITADEL
MINIATURES

Designed by Trish Morrison

355

Not recommended for children under 8 years due to small parts and essential pointed components. All models supplied unpainted.
© Copyright Games Workshop Ltd. 1998. All rights reserved.

DOGS OF WAR

GOLGFAG'S OGRES



DRUMMER'S BODY
021401209



DRUMMER'S RIGHT ARM
021401213



DRUMMER'S LEFT ARM
021401219



DRUMMER'S HEAD
021401210



DRUM
021401211



GOLGFAG'S BODY
021401201



GOLGFAG'S HEAD
021401202



GOLGFAG'S RIGHT ARM 1
021401203



GOLGFAG'S LEFT ARM 4
021401204

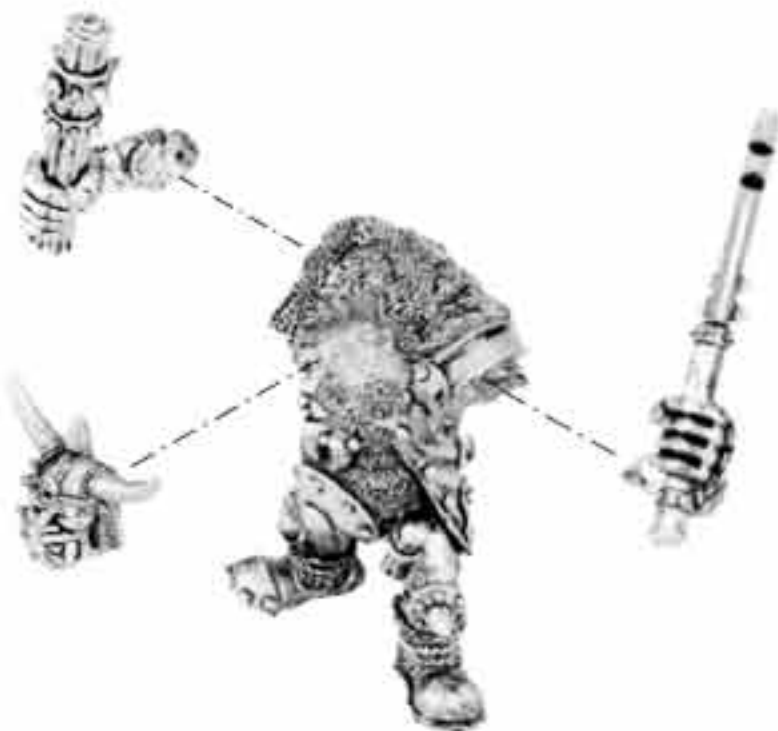

Please note that these components are not interchangeable. For example Ogre left arm 1 will not fit Ogre body 2, Ogre body 1 will not fit Golgfag's head, and so on.



GOLGFAG



WARHAMMER®

ASARNIL THE DRAGONLORD



ASARNIL THE DRAGONLORD
021402801



ASARNIL'S SWORD
021402804



ASARNIL'S SHIELD
021402803



ASARNIL'S SADDLE
021402805



ASARNIL'S BANNER POLE
021402802



- A COMPLETE
ASARNIL THE DRAGONLORD
CONSISTS OF:**
- 1 x ASARNIL THE DRAGONLORD
 - 1 x ASARNIL'S BANNER POLE
 - 1 x ASARNIL'S SWORD
 - 1 x ASARNIL'S SHIELD
 - 1 x ASARNIL'S SADDLE
 - 1 x DRAGON (SUPPLIED ON PLASTIC SPRUE)



CITADEL
MINIATURES



CITADEL
MINIATURES

Asarnil designed by Chris FitzPatrick. Dragon designed by Trish Morrison

Not recommended for children under 8 years due to small parts and essential pointed components. All models supplied unpainted.
© Copyright Games Workshop Ltd. 1998. All rights reserved.

DWARFS

DWARF PLASTIC SPRUE

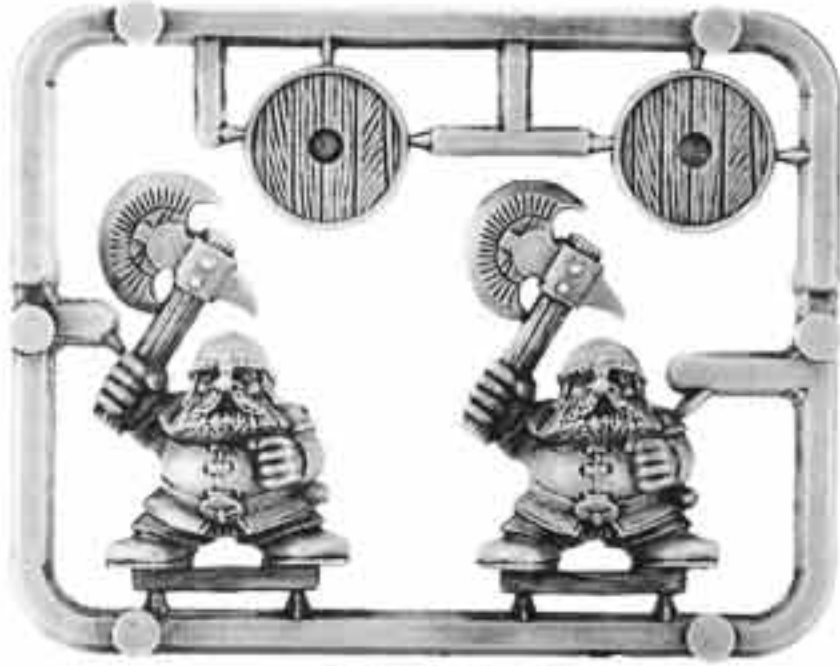

DWARF PLASTIC SPRUE
103305



PLASTIC DWARF



DWARFS

HAMMERERS COMMAND GROUP



DWARF HAMMERER
CHAMPION
020501601



DWARF HAMMERER
HORNBLOWER
020501604



DWARF HAMMERER
STANDARD BEARER
020501602



HAMMERER
STANDARD TOP
020501603

A COMPLETE DWARF HAMMERER
STANDARD BEARER CONSISTS OF :
1 x HAMMERER STANDARD BEARER
1 x SMALL ROUND SHIELD SPRUE
1 x HAMMERER STANDARD TOP

HAMMERERS



DWARF HAMMERER 1
020501501



DWARF HAMMERER 2
020501502



DWARF HAMMERER 3
020501503



DWARF HAMMERER 4
020501504

THESE MODELS ARE SUPPLIED WITH A SMALL ROUND SHIELD SPRUE



DWARF HAMMERERS



SMALL ROUND SHIELD SPRUE
111205



Designed by Colin Dixon

Not suitable for children under 36 months due to small parts and essential pointed components. All models supplied unpainted.
© Copyright Games Workshop Ltd., 1997. All rights reserved.

DWARFS

LONG BEARDS



LONG BEARD 1
020502715



LONG BEARD 3
020502717



LONG BEARD 4
020502718



LONG BEARD 6
020502732



LONG BEARD 7
020502733

A COMPLETE DWARF LONG BEARD
CONSISTS OF
1 x DWARF LONG BEARD
1 x PLASTIC SHIELD



TROLL SLAYER COMMAND

A COMPLETE TROLL SLAYER
STANDARD BEARER
CONSISTS OF
1 x TROLL SLAYER STANDARD BEARER
1 x TROLL SLAYER STANDARD TOP



TROLL SLAYER
STANDARD TOP
020502102



TROLL SLAYER
STANDARD BEARER
020502101



TROLL SLAYER
MUSICIAN
020502103



DWARFS

TROLL SLAYERS



TROLL SLAYER
WITH AXE 1
020502510



TROLL SLAYER
WITH AXE 2
020502507



TROLL SLAYER
WITH AXE 3
020502505



TROLL SLAYER
WITH AXE 4
020502504



TROLL SLAYER 1
020502557



TROLL SLAYER 2
020502551



TROLL SLAYER 3
020502552



TROLL SLAYER 5
020502512



TROLL SLAYER 6
020502513



TROLL SLAYER 4
020502511

GIANT SLAYERS



GIANT SLAYER 2
020502601



GIANT SLAYER 4
020502602



GIANT SLAYER 5
020502603



GIANT SLAYER 1
020502654



GIANT SLAYER 3
020502653

DRAGON SLAYERS



DRAGON SLAYER 1
020502955



DRAGON SLAYER 2
020502901



DRAGON SLAYER 3
079902001

DAEMON SLAYERS



DAEMON SLAYER 2
020503001



DAEMON SLAYER 1
020503056

Designed by Aly Morrison and Colin Dixon

Not suitable for children under 8 years due to small parts and essential pointed components. All models supplied unpainted.
© Copyright Games Workshop Ltd. 1998. All rights reserved.



DWARFS

DWARF HERO



MINER HERO
020501801

MINERS COMMAND GROUP



MINER CHAMPION
020503802



MINER TRUMPETER
020503202



MINER STANDARD BEARER
020503201

MINERS



MINER 1
020503101



MINER 2
020503102



MINER 3
020503103



MINER 4
020503104



MINER 5
020503105

DRUNKEN DWARFS



DRINKING MINER
020501901



DRUNKEN DWARF 1
020501902



DRUNKEN DWARF 2
020501903



DRINKING CROSSBOWMAN
020501904



DWARFS

DWARF THUNDERERS



DWARF THUNDERER 1
020502827



DWARF THUNDERER 2
020502828



DWARF THUNDERER 3
020502829



DWARF THUNDERER 4
020502830



DWARF THUNDERER 5
020502835



DWARF THUNDERER 6
020502836



DWARF THUNDERER 7
020502837



DWARF THUNDERER 8
020502838



DWARF THUNDERER 9
020502839



DWARF THUNDERER 10
020502840



DWARF THUNDERER 11
020502841



DWARF THUNDERER 12
020502842



Designed by Aly Morrison and Colin Dixon

DWARFS

DWARF RUNESMITH'S ANVIL OF DOOM



ANVIL OF DOOM
RUNEPRIEST
020500202



ANVIL OF DOOM GUARDIAN
020500201



ANVIL OF DOOM



ANVIL OF DOOM
BANNER POLE
020500206



ANVIL OF DOOM ANVIL
020500203



ANVIL OF DOOM BASE
020500204



ANVIL OF DOOM PEDESTAL
020500205



PLASTIC SPOKED WHEEL SPRUE
100557

A COMPLETED ANVIL OF DOOM CONSISTS OF:

- 1 x ANVIL OF DOOM RUNEPRIEST
- 2 x ANVIL OF DOOM GUARDIAN
- 1 x ANVIL OF DOOM ANVIL
- 1 x ANVIL OF DOOM PEDESTAL
- 1 x ANVIL OF DOOM BASE
- 2 x ANVIL OF DOOM BANNER POLES
- 2 x PLASTIC SPOKED WHEEL SPRUES

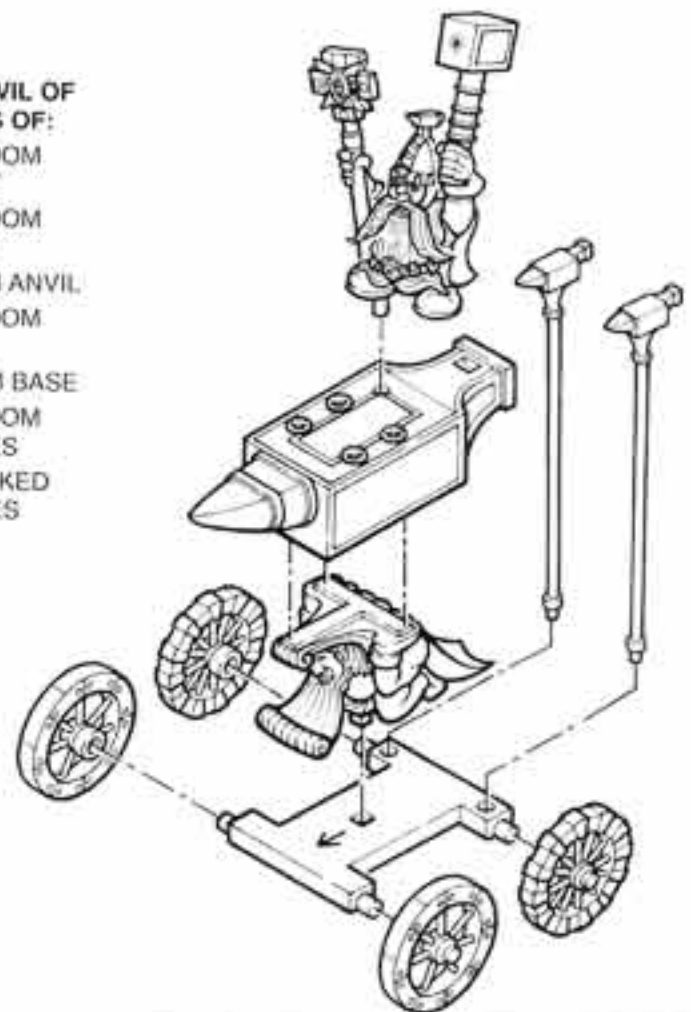

DWARFS

THRONE OF POWER



THORGRIM GRUDGEBEARER
020500105

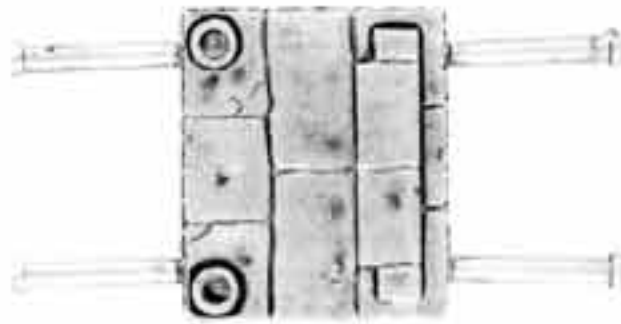

THRONE OF POWER
PLATFORM
020500101



THRONE OF POWER SEAT
020500104



THRONE OF POWER



THRONE OF POWER
BEARER 1
020500106



THRONE OF POWER
BEARER 2
020500107



THRONE OF POWER
BEARER 3
020500108



THRONE OF POWER
BEARER 4
020500109



THRONE OF POWER
BANNER POLE
020500103



THRONE OF POWER BACK
020500102

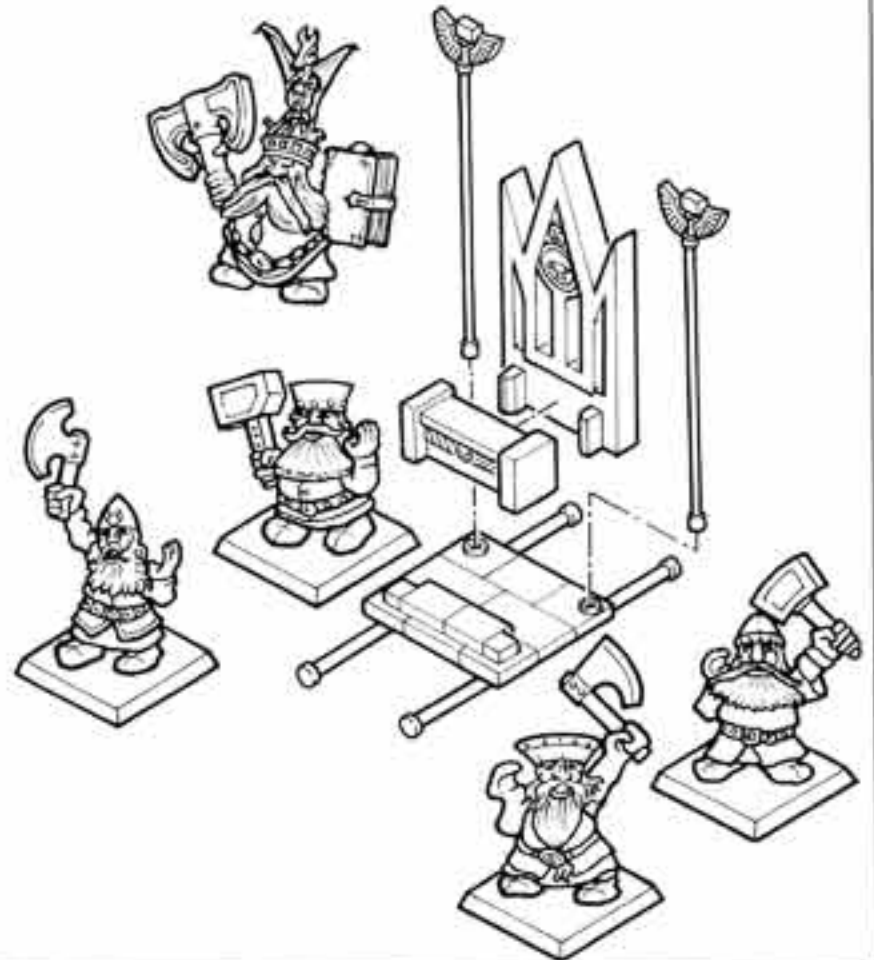

A COMPLETED THRONE OF POWER CONSISTS OF:

- 1 x THRONE OF POWER PLATFORM
- 1 x THRONE OF POWER BACK
- 2 x THRONE OF POWER BANNER POLES
- 1 x THRONE OF POWER SEAT
- 1 x THORGRIM GRUDGEBEARER
- 1 x THRONE OF POWER BEARER 1
- 1 x THRONE OF POWER BEARER 2
- 1 x THRONE OF POWER BEARER 3
- 1 x THRONE OF POWER BEARER 4



CITADEL
MINIATURES



CITADEL
MINIATURES

Designed by Michael Perry

365

Not suitable for children under 36 months due to small parts and essential pointed components. All models supplied unpainted.
© Copyright Games Workshop Ltd., 1997. All rights reserved.

DWARFS

DWARF GENERALS



DWARF GENERAL
020501201



DWARF QUEEN
020501301

RUNESMITH



DWARF RUNESMITH
020501701

DWARF HERO



DWARF HERO
020502001



DWARF GENERAL AND DWARF QUEEN

A COMPLETED DWARF GENERAL
CONSISTS OF:
1 x DWARF GENERAL
1 x SMALL ROUND SHIELD SPRUE

A COMPLETED DWARF QUEEN
CONSISTS OF:
1 x DWARF QUEEN
1 x SMALL ROUND SHIELD SPRUE



SMALL ROUND SHIELD SPRUE
111205

THE WHITE DWARF



WHITE DWARF
BODY
020501101



WHITE DWARF
AXE
020501102



THE WHITE DWARF

A COMPLETED WHITE DWARF
CONSISTS OF:
1 x WHITE DWARF BODY
1 x WHITE DWARF AXE



DWARFS

GOTREK AND FELIX



GOTREK GURNISSON
020500401



FELIX JAEGAR
020500402

BUGMAN'S DWARF RANGERS



BUGMAN'S BODY
020501001



BUGMAN'S BANNER POLE
020501002

THE COMPLETE
JOSEPH BUGMAN
CONSISTS OF:
1 x BUGMAN'S BODY
1 x BUGMAN'S
BANNER POLE



JOSEPH BUGMAN



BUGMAN'S TROOPER 1
020503505



BUGMAN'S TROOPER 2
020503506



**BUGMAN'S STANDARD
BEARER**
020503904



BUGMAN'S TROOPER 3
020503507



BUGMAN'S CHAMPION
020503903

THESE MINIATURES ARE SUPPLIED WITH THE APPROPRIATE PLASTIC SHIELDS AS STANDARD



Designed by Michael Perry

DWARFS

RUNE LORD KRAGG THE GRIM



KRAGG THE GRIM'S BODY
020500801



KRAGG THE GRIM'S
BANNER POLE
020500802

THE COMPLETE KRAGG THE GRIM
CONSISTS OF:
1 x KRAGG THE GRIM'S BODY
1 x KRAGG THE GRIM'S BANNER POLE



RUNE LORD KRAGG THE GRIM

ENGINEER GUILDMASTER BURLOCK DAMMINSON



BURLOCK DAMMINSON'S
BODY
020500701



BURLOCK DAMMINSON'S
BANNER POLE
020500702

THE COMPLETE BURLOCK
DAMMINSON CONSISTS OF:
1 x BURLOCK DAMMINSON'S BODY
1 x BURLOCK DAMMINSON'S
BANNER POLE



BURLOCK DAMMINSON



DWARFS

DWARF KING KAZADOR



KING KAZADOR'S BODY
020500501



KING KAZADOR'S
BANNER POLE
020500503

THE COMPLETE KING KAZADOR
CONSISTS OF:
1 x KING KAZADOR'S BODY
1 x KING KAZADOR'S
BANNER POLE
1 x KING KAZADOR'S
THUNDER ARM



KING KAZADOR'S THUNDER HORN
020500502



KING KAZADOR

UNGRIM IRONFIST THE SLAYER KING



UNGRIM IRONFIST'S BODY
020500601

THE COMPLETE UNGRIM IRONFIST
CONSISTS OF:
1 x UNGRIM IRONFIST'S BODY
1 x UNGRIM IRONFIST'S BANNER POLE



UNGRIM IRONFIST



UNGRIM IRONFIST'S BANNER POLE
020500602



CITADEL
MINIATURES



CITADEL
MINIATURES

Designed by Michael Perry

Not suitable for children under 36 months due to small parts and essential pointed components. All models supplied unpainted.
© Copyright Games Workshop Ltd., 1997. All rights reserved.

DWARFS

DWARF FLAME CANNON

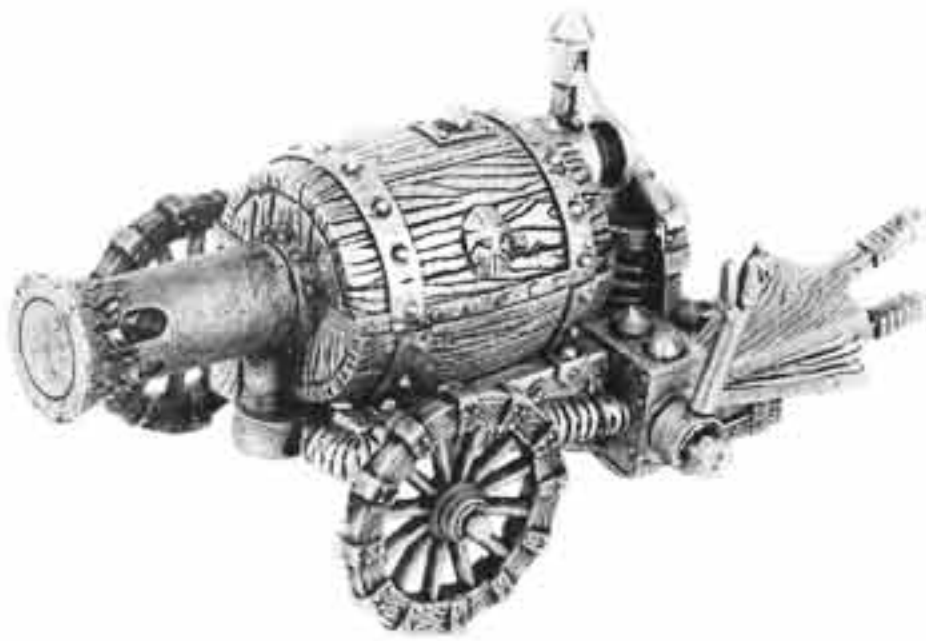

DWARF FLAME CANNON

A COMPLETED DWARF FLAME CANNON CONSISTS OF:

- 1 x FLAME CANNON MASTER GUNNER
- 1 x FLAME CANNON LOADER
- 1 x FLAME CANNON SWABBER
- 1 x FLAME CANNON CANNON
- 1 x FLAME CANNON UPPER BARREL
- 1 x FLAME CANNON LOWER BARREL
- 1 x FLAME CANNON LEVER
- 1 x FLAME CANNON BELLOWS
- 1 x FLAME CANNON PUMP
- 1 x FLAME CANNON STEAM WHISTLE
- 1 x FLAME CANNON INSTRUMENTS PANEL
- 1 x FLAME CANNON FRONT BASE
- 1 x FLAME CANNON REAR BASE
- 2 x PLASTIC SPOKED WHEELS



FLAME CANNON
MASTER GUNNER
020500301



FLAME CANNON
LOADER
020500302



FLAME CANNON
SWABBER
020500303



FLAME CANNON
FRONT BASE
020500307

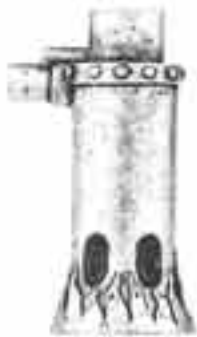

FLAME CANNON
CANNON
020500308



FLAME CANNON
LEVER
020500311



FLAME CANNON
BELLOWS
020500313



PLASTIC
SPOKED WHEEL
100557



FLAME CANNON
REAR BASE
020500306

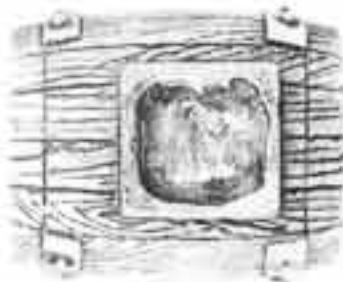

FLAME CANNON
UPPER BARREL
020500304



FLAME CANNON
PUMP
020500310



FLAME CANNON
STEAM WHISTLE
020500312



FLAME CANNON
LOWER BARREL
020500305



FLAME CANNON
INSTRUMENT PANEL
020500309

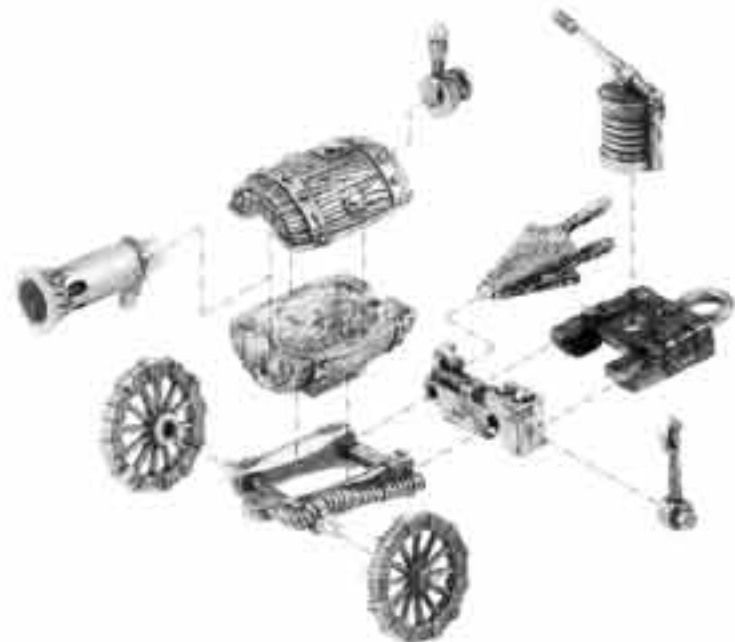

DWARFS

BOLT THROWER



BOLT THROWER CARRIAGE
020504204

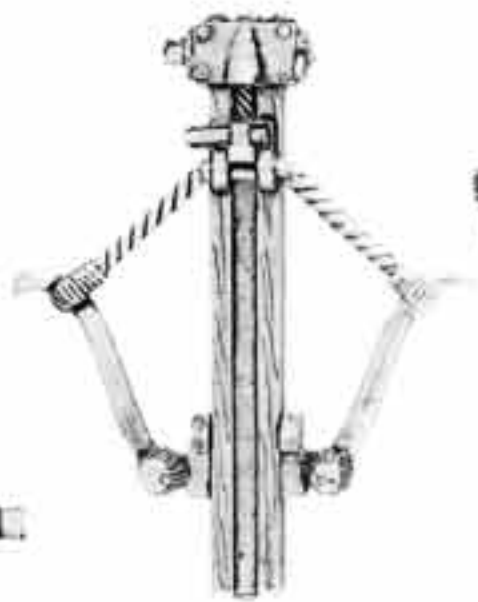

BOLT THROWER BOW
020504205



BOLT THROWER HANDLE
020501404



BOLT THROWER FRONT FRAME
020504206



BOLT THROWER CREW 1
020504201



BOLT THROWER CREW 2
020504202



BOLT THROWER CREW 3
020504203



BOLT THROWER BOLT
020504207

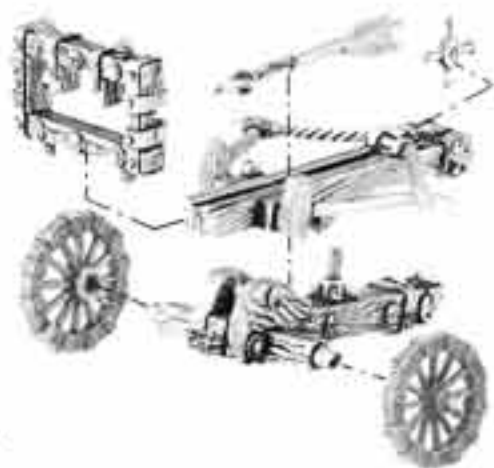

A COMPLETED DWARF BOLT THROWER CONSISTS OF:

- 1 x BOLT THROWER CARRIAGE
- 1 x BOLT THROWER BOW
- 1 x BOLT THROWER FRONT FRAME
- 1 x BOLT THROWER BOLT
- 1 x BOLT THROWER CREW 1
- 1 x BOLT THROWER CREW 2
- 1 x BOLT THROWER CREW 3
- 1 x PLASTIC WHEEL SPRUE
- 1 x BOLT THROWER HANDLE



BOLT THROWER

ORGAN GUN



ORGAN GUN CREW 1
020504101



ORGAN GUN CREW 2
020504102



ORGAN GUN CREW 3
020504103



ORGAN GUN CARRIAGE
020504106

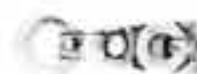

ORGAN GUN COUPLING
020504108



ORGAN GUN AXLE
020504107



ORGAN GUN FRONT PANEL
020504105



ORGAN GUN LEVER
020504109

A COMPLETED DWARF ORGAN GUN CONSISTS OF:

- 1 x ORGAN GUN CARRIAGE
- 1 x ORGAN GUN GUN BARREL
- 1 x ORGAN GUN FRONT PANEL
- 1 x ORGAN GUN LEVER
- 1 x ORGAN GUN COUPLING
- 1 x ORGAN GUN CREW 1
- 1 x ORGAN GUN CREW 2
- 1 x ORGAN GUN CREW 3
- 1 x PLASTIC WHEEL SPRUE

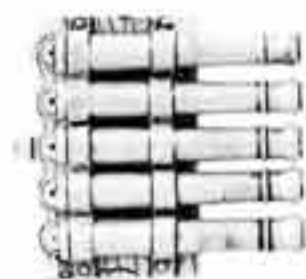

ORGAN GUN GUN BARRELS
020504104

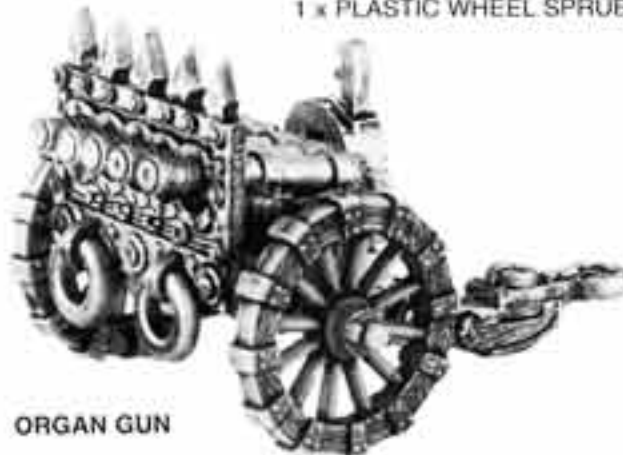

ORGAN GUN



Organ Gun and Bolt Thrower Designed by Norman Swales, Crews Designed by Colin Dixon

Not suitable for children under 36 months due to small parts and essential pointed components. All models supplied unpainted.
© Copyright Games Workshop Ltd., 1997. All rights reserved.

DWARFS

DWARF CANNON



CREW 1
020501403

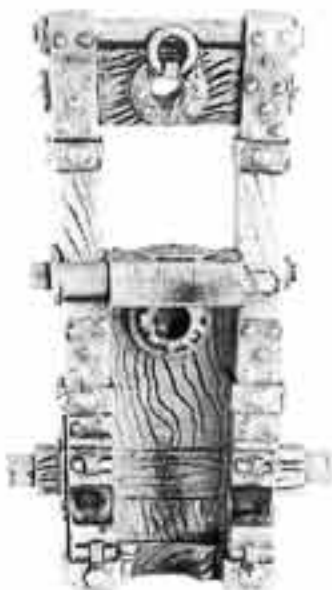

CHASSIS
020501405



BARREL
020501406



CREW 2
020501402



HANDLE
020501404



CREW3
020501401



SPOKED WHEEL
100557



A COMPLETED DWARF CANNON CONSISTS OF:

- 1 x CREW 1
- 1 x CREW 2
- 1 x CREW 3
- 1 x BARREL
- 1 x CHASSIS
- 2 x SPOKED WHEELS
- 1 x HANDLE



DWARF CANNON



DWARFS

DWARF GYROCOPTER



GYROCOPTER PILOT
020500901



GYROCOPTER



GYROCOPTER ENGINE
0205000903



GYROCOPTER PROPELLER
020500905



GYROCOPTER CANNON CHASSIS
0205000902



GYROCOPTER TAIL
0205000904

THE COMPLETE DWARF GYROCOPTER CONSISTS OF:
1 x GYROCOPTER PILOT
1 x GYROCOPTER CANNON CHASSIS
1 x GYROCOPTER ENGINE
1 x GYROCOPTER TAIL
1 x GYROCOPTER PROPELLER

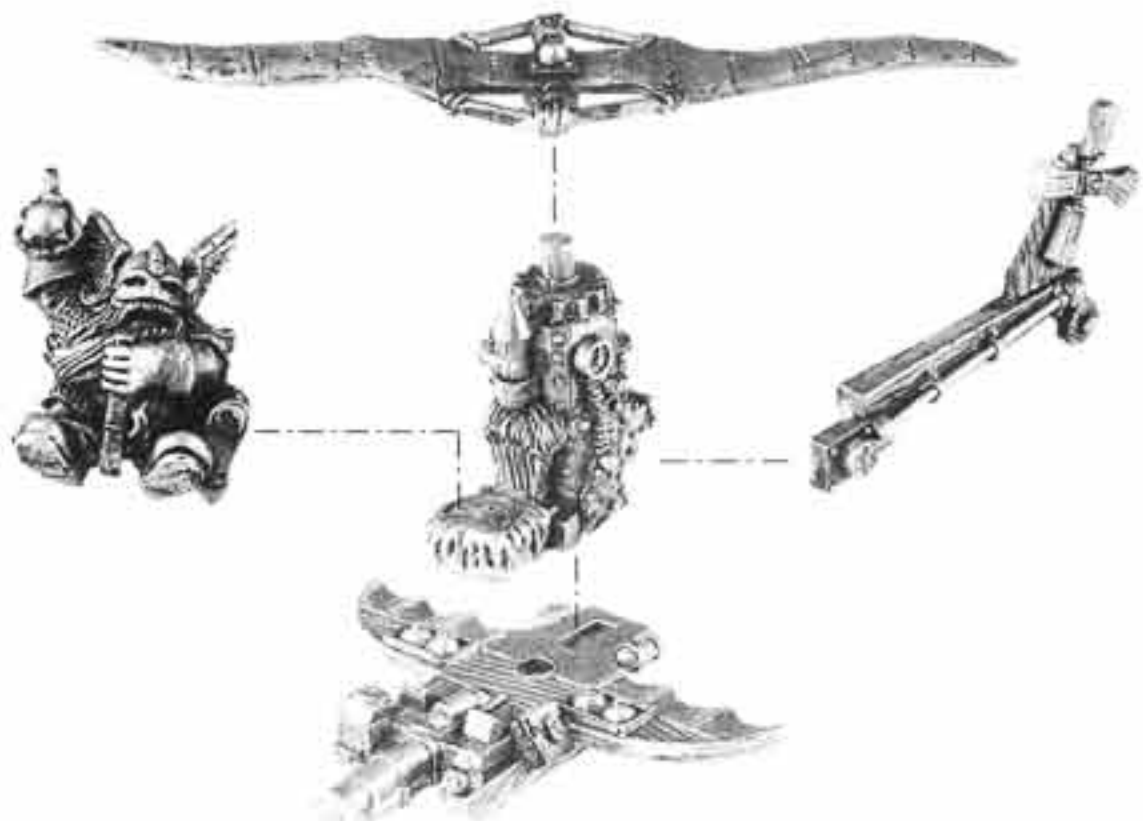

CITADEL
MINIATURES



CITADEL
MINIATURES

Designed by Norman Swales and Michael Perry

Not suitable for children under 36 months due to small parts and essential pointed components. All models supplied unpainted.
© Copyright Games Workshop Ltd., 1997. All rights reserved.

EMPIRE

SOLDIERS OF THE EMPIRE

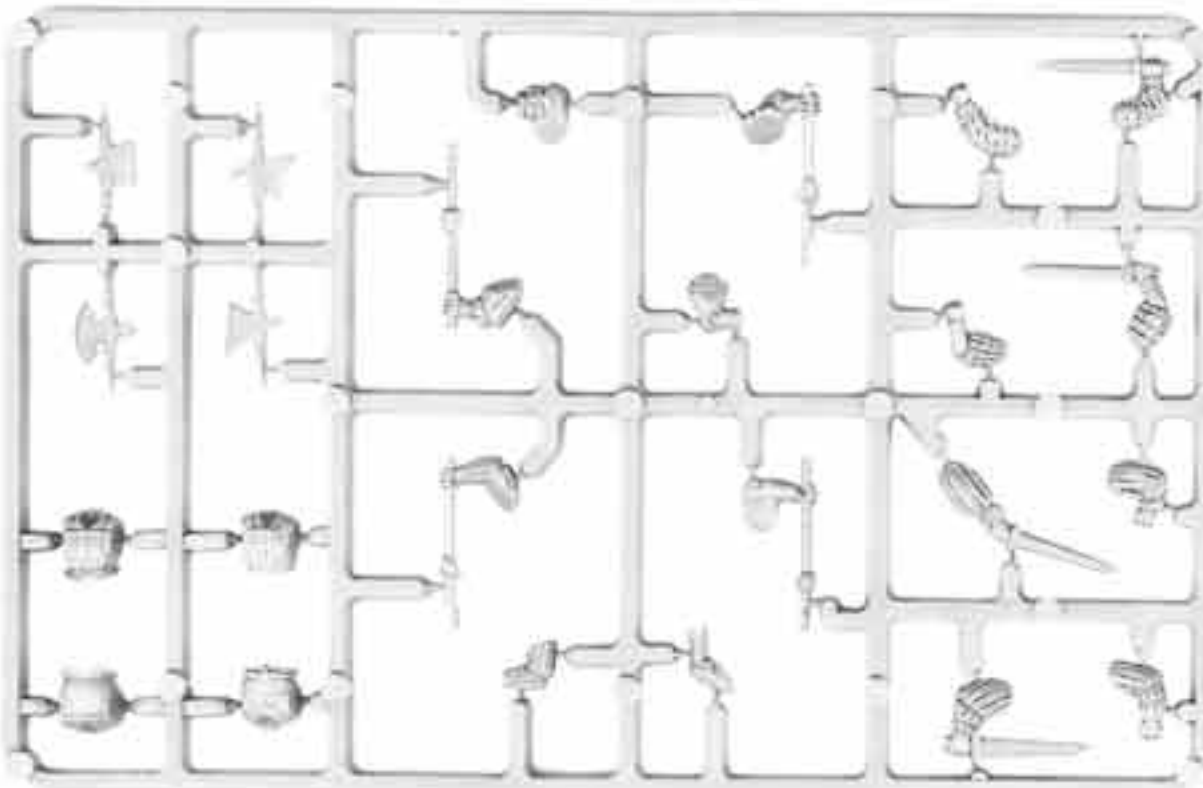

EMPIRE SHIELD SPRUE
99360299003

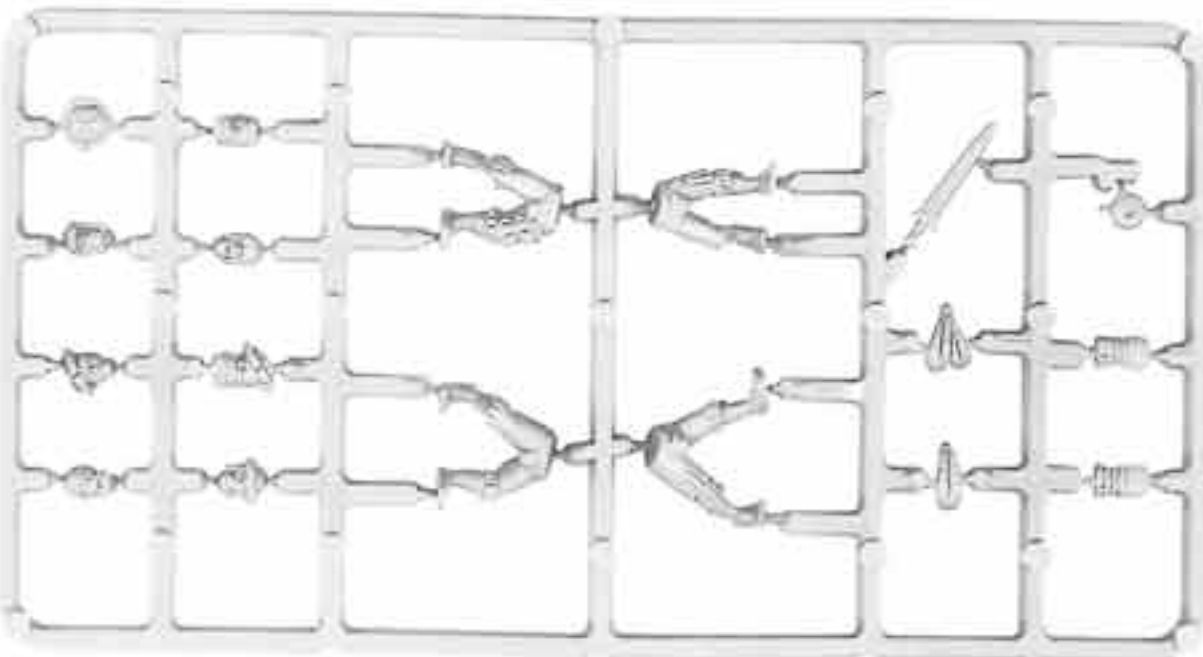

EMPIRE REGIMENT SPRUE
99399999064
SHOWN AT 60% ACTUAL SIZE



SOLDIERS OF THE EMPIRE



EMPIRE

EMPIRE HANDGUNNERS



LEADER HEAD
020206202



**STANDARD BEARER
LEFT ARM**
020206205



**STANDARD BEARER
RIGHT ARM**
020206204



POWDER BAGS 1
020206206



LEADER'S ARMS
020206201



BUGLE
020206203



POWDER BAGS 2
020206207



HANDGUNNER'S ARMS 1
020206208



HANDGUNNER'S ARMS 2
020206209



HANDGUNNER'S ARMS 3
020206210



HANDGUNNER'S ARMS 4
020206211

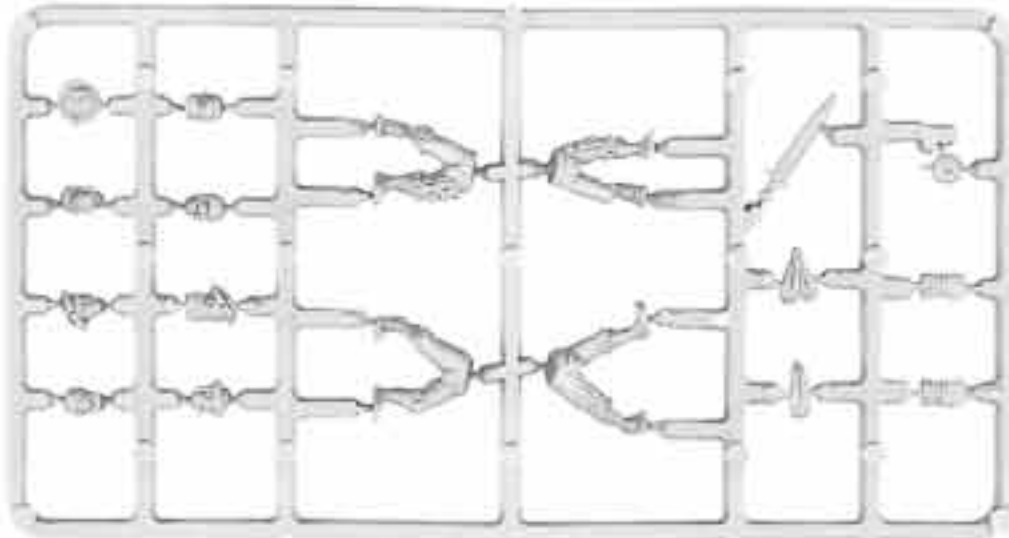
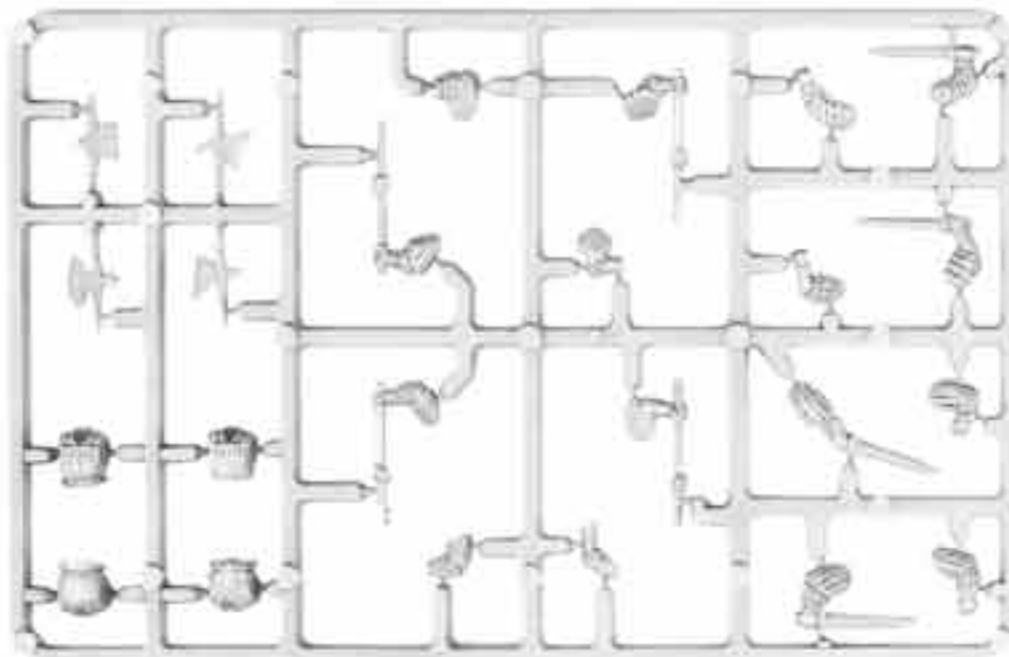

EMPIRE REGIMENT SPRUE
99399999064
SHOWN AT 50% ACTUAL SIZE



EMPIRE HANDGUNNERS



Designed by Michael and Alan Perry

Not recommended for children under 8 years due to small parts and essential pointed components. All models supplied unpainted.
© Copyright Games Workshop Ltd. 1998. All rights reserved.

EMPIRE

IMPERIAL ARCHERS



ARCHER 1
020203401



ARCHER 2
020203402



ARCHER 3
020203403



ARCHER 4
020203404



ARCHER 5
020203405



ARCHER 6
020203406



ARCHER 7
020203407



ARCHER 8
020203408



ARCHER 9
020203409

TILEAN CROSSBOWMEN



TILEAN CROSSBOWMAN 1
020203806



TILEAN CROSSBOWMAN 2
020203807



TILEAN CROSSBOWMAN 3
020203808



TILEAN CROSSBOWMAN 4
020203812



TILEAN CROSSBOWMAN 5
020203809



TILEAN CROSSBOWMAN 6
020203810



TILEAN CROSSBOWMAN 7
020203811



TILEAN CROSSBOWMAN



EMPIRE

IMPERIAL REIKSGUARD FOOT KNIGHTS

THESE MINIATURES ARE SUPPLIED WITH THE APPROPRIATE PLASTIC SHIELDS AS STANDARD



REIKSGUARD CAPTAIN
020203508



REIKSGUARD MUSICIAN
020203507



REIKSGUARD
STANDARD BEARER
020203506



REIKSGUARD 2
020203502



REIKSGUARD 3
020203503



REIKSGUARD 4
020203504



REIKSGUARD 5
020203505



IMPERIAL REIKSGUARD
FOOT KNIGHT

IMPERIAL GREAT SWORDS



IMPERIAL
GREAT SWORD 1
020201501



IMPERIAL
GREAT SWORD 2
020201502



IMPERIAL
GREAT SWORD 3
020201503



Designed by Michael Perry and Alan Perry

Not suitable for children under 36 months due to small parts and essential pointed components. All models supplied unpainted.
© Copyright Games Workshop Ltd., 1997. All rights reserved.

EMPIRE

REIKSGUARD KNIGHTS



REIKSGUARD KNIGHT



REIKSGUARD KNIGHT BODY 1
020201301



REIKSGUARD KNIGHT BODY 2
020201302

A COMPLETE REIKSGUARD KNIGHT
CONSISTS OF:
1 x REIKSGUARD KNIGHT BODY
1 x KNIGHT'S LEGS
1 x ARMoured PLASTIC HORSE
1 x PLASTIC SHIELD



KNIGHT'S LEGS
020200903

KNIGHTS OF THE BLAZING SUN



GRAND MASTER OF THE
KNIGHTS OF THE BLAZING SUN



KNIGHT OF THE BLAZING SUN
BODY 1
020200201



KNIGHT OF THE BLAZING SUN
BODY 2
020200202



KNIGHT'S LEGS
020200903

A COMPLETE KNIGHT OF
THE BLAZING SUN
CONSISTS OF:
1 x KNIGHT OF THE
BLAZING SUN BODY
1 x KNIGHT'S LEGS
1 x ARMoured PLASTIC
HORSE
1 x PLASTIC SHIELD

A COMPLETE GRANDMASTER OF
THE KNIGHTS OF THE BLAZING
SUN CONSISTS OF:
1 x GRANDMASTER OF THE
KNIGHTS OF THE BLAZING
SUN
1 x ARMoured PLASTIC HORSE
1 x PLASTIC SHIELD



GRANDMASTER OF THE
KNIGHTS OF THE BLAZING SUN
020200304



KNIGHT OF THE BLAZING SUN
STANDARD BEARER BODY
020200203



CITADEL
MINIATURES



CITADEL
MINIATURES

EMPIRE

TZARINA KATARIN, THE ICE QUEEN OF KISLEV



THE ICE QUEEN OF KISLEV BODY
020201401



TZARINA KATARIN
THE ICE QUEEN OF KISLEV

THIS MINIATURE IS SUPPLIED WITH A
PLASTIC HORSE AS STANDARD



KISLEV WINGED LANCERS



WINGED LANCER BODY 1
020200703

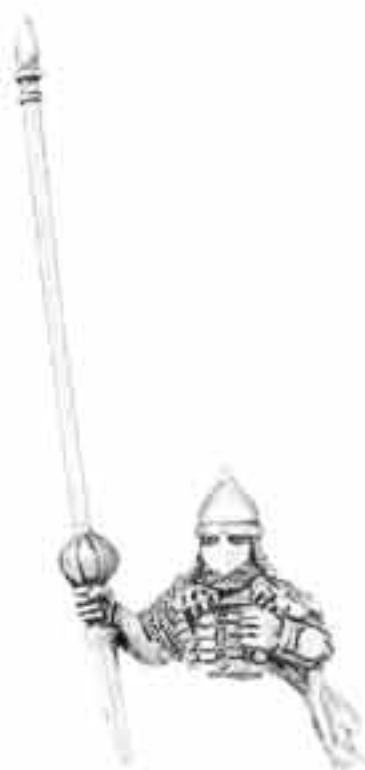

WINGED LANCER BODY 2
020200704



LANCER WING
020200702



WINGED LANCER LEGS
020200701



KISLEV WINGED LANCER



WINGED LANCER
STANDARD BEARER BODY
020200805



WINGED LANCER
CHAMPION BODY
020200806



WINGED LANCER
DRUMMER BODY
020200807

A COMPLETE KISLEV WINGED
LANCER CONSISTS OF:
1 x WINGED LANCER BODY
1 x LANCER WING
1 x LANCER LEGS
1 x PLASTIC HORSE



Designed by Michael Perry

379

Not suitable for children under 8 years due to small parts and essential pointed components. All models supplied unpainted.
© Copyright Games Workshop Ltd. 1998. All rights reserved.

EMPIRE

KISLEV HORSE ARCHERS



HORSE ARCHER 1
020200507



HORSE ARCHER 2
020200508



HORSE ARCHER 3
020200510



HORSE ARCHER 4
020200511



HORSE ARCHER WITH SWORD 1
020200509



HORSE ARCHER WITH SWORD 2
020200506



HORSE ARCHER LEGS 1
020200512



HORSE ARCHER LEGS 2
020200504



HORSE ARCHER LEGS 3
020200505



HORSE ARCHER CHIEFTAIN
020200601



HORSE ARCHER HORN BLOWER
073749/2



HORSE ARCHER STANDARD BEARER
020200603

A COMPLETE KISLEV HORSE ARCHER CONSISTS OF:
1 x HORSE ARCHER BODY
1 x HORSE ARCHER LEGS
1 x PLASTIC HORSE



KISLEV HORSE ARCHER STANDARD BEARER



KISLEV HORSE ARCHER CHIEFTAIN



EMPIRE

KNIGHTS OF THE WHITE WOLF



GRANDMASTER OF THE
WHITE WOLF



KNIGHT'S LEGS
020200903



KNIGHT OF THE WHITE WOLF
BODY 1
020200901



KNIGHT OF THE WHITE WOLF
BODY 2
020200902



KNIGHT OF THE WHITE WOLF
BODY 3
020200904



KNIGHT OF THE WHITE WOLF
STANDARD BEARER BODY
020201105



GRANDMASTER OF THE
KNIGHTS OF THE WHITE WOLF
020201006

A COMPLETE KNIGHT OF THE
WHITE WOLF CONSISTS OF:
1 x KNIGHT OF THE WHITE
WOLF BODY
1 x KNIGHT'S LEGS
1 x ARMoured PLASTIC
HORSE

A COMPLETE GRANDMASTER
OF THE KNIGHTS OF THE
WHITE WOLF CONSISTS OF:
1 x GRANDMASTER OF THE
KNIGHTS OF THE WHITE WOLF
1 x ARMoured PLASTIC
HORSE

KNIGHTS PANTHER



GRANDMASTER OF THE KNIGHTS PANTHER



KNIGHTS PANTHER
BODY 1
020202401



KNIGHTS PANTHER
BODY 2
020202402



KNIGHTS PANTHER
STANDARD BEARER BODY
020202604



GRANDMASTER OF THE
KNIGHTS PANTHER BODY
020202505

A COMPLETE KNIGHTS
PANTHER CONSISTS OF:
1 x KNIGHTS PANTHER BODY
1 x KNIGHT'S LEGS
1 x ARMoured PLASTIC
HORSE
1 x PLASTIC FIGHTER SHIELD

A COMPLETE GRAND MASTER OF
THE KNIGHTS PANTHER
CONSISTS OF:
1 x GRAND MASTER OF THE
KNIGHTS PANTHER BODY
1 x ARMoured PLASTIC HORSE
1 x PLASTIC FIGHTER SHIELD



KNIGHT'S LEGS
020200903



Designed by Michael Perry and Alan Perry

Not suitable for children under 36 months due to small parts and essential pointed components. All models supplied unpainted.
© Copyright Games Workshop Ltd., 1997. All rights reserved.

EMPIRE

IMPERIAL OUTRIDERS



IMPERIAL OUTRIDER



OUTRIDER WITH
REPEATING PISTOL BODY
020200401



OUTRIDER WITH
REPEATING MUSKET BODY
020200402



KNIGHT'S LEGS
020200903

A COMPLETE IMPERIAL OUTRIDER
CONSISTS OF:
1 x OUTRIDER BODY
1 x KNIGHT'S LEGS
1 x ARMoured PLASTIC HORSE

IMPERIAL PISTOLIER



IMPERIAL PISTOLIER



PISTOLIER BODY 1
020201201



PISTOLIER BODY 2
020201202



PISTOLIER BODY 3
020201203



PISTOLIER LEGS
020201204

A COMPLETE IMPERIAL PISTOLIER
CONSISTS OF:
1 x PISTOLIER BODY
1 x PISTOLIER LEGS
1 x UNARMoured PLASTIC HORSE

HEROES OF THE EMPIRE



HERO OF THE EMPIRE



HEROIC KNIGHT WITH
WARHAMMER
020201304



HEROIC KNIGHT WITH
BROADSWORD
020201305



HEROIC KNIGHT WITH
LANCE
020201306

THESE FIGURES ARE SUPPLIED WITH PLASTIC ARMoured HORSES AS STANDARD



EMPIRE

GENERAL OF THE EMPIRE



BODY
020204601

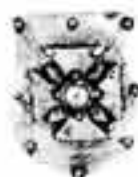

SHIELD
020204603



LANCE
020204602

THE COMPLETE GENERAL OF THE EMPIRE CONSISTS OF:
1 x BODY
1 x SHIELD
1 x LANCE
1 x PLASTIC ARMoured HORSE



GENERAL OF THE EMPIRE



ARMoured HORSE
HEAD AND TAIL 2
100849/2A



ARMoured HORSE 1
100849/3A



ARMoured HORSE 2
100849/4A



ARMoured HORSE
HEAD AND TAIL 1
100849/1A



EMPIRE HEROES



IMPERIAL NOBLE
079901801



WITCH HUNTER
079902201



WARRIOR PRIEST
079901701



PIT FIGHTER
079901601



Designed by Aly Morrison and Gary Morley

Not suitable for children under 8 years due to small parts and essential pointed components. All models supplied unpainted.
© Copyright Games Workshop Ltd. 1998. All rights reserved.

EMPIRE

ELECTOR COUNTS



ELECTOR COUNT



ELECTOR COUNT OF
MIDDENHEIM
020201604



ELECTOR COUNT OF
HOCHLAND
020201703



ELECTOR COUNT OF
OSTLAND
020201801



ELECTOR COUNT OF
AVERLAND
020201902

THESE FIGURES ARE SUPPLIED
WITH PLASTIC ARMoured OR
HORSES AS STANDARD

HEROES OF THE EMPIRE



ELECTOR COUNT

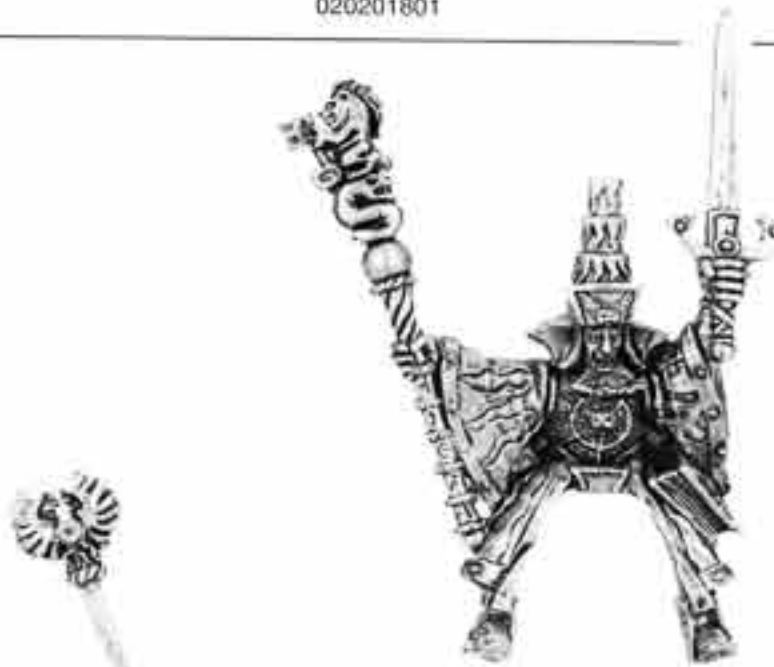

SUPREME PATRIARCH OF THE
COLLEGES OF MAGIC
020202103



LUDWIG SCHWARZHELM
THE EMPEROR'S CHAMPION
020202202



KURT HELBORG, CAPTAIN OF THE
REIKSGUARD KNIGHTS
020202001

THESE FIGURES ARE SUPPLIED
WITH PLASTIC ARMoured OR
CAPARISON HORSES AS STANDARD



EMPIRE

IMPERIAL HALFLING COMMAND



HALFLING CHAMPION
020202901



HALFLING DRUMMER
020202902



HALFLING STANDARD BEARER
020202903

IMPERIAL HALFLING BOWMEN



HALFLING WITH BOW 1
020202708



HALFLING WITH BOW 2
020202709



HALFLING WITH BOW 3
020202718



HALFLING WITH BOW 4
020202717



HALFLING WITH BOW 5
020202715



HALFLING WITH BOW 6
020202716



IMPERIAL HALFLING HOT POT CATAPULT



IMPERIAL HALFLING HOT POT CATAPULT



HALFLING COOKING POT
020202813



HALFLING CATAPULT BASE
020202814



HALFLING COOK WITH ROPE 1
020202811



HALFLING COOK WITH ROPE 2
020202812



HALFLING COOK WITH CLEAVER
020202810

A COMPLETE IMPERIAL HALFLING HOT POT CATAPULT CONSISTS OF:
1 x HALFLING COOK WITH CLEAVER
1 x HALFLING COOK WITH ROPE 1
1 x HALFLING COOK WITH ROPE 2
1 x HALFLING COOKING POT
1 x HALFLING CATAPULT BASE



Designed by Alan Perry

Not suitable for children under 8 years due to small parts and essential pointed components. All models supplied unpainted.
© Copyright Games Workshop Ltd. 1998. All rights reserved.

EMPIRE

IMPERIAL MORTAR



MORTAR CREW 1
020204701



MORTAR CREW 2
020204702



MORTAR CREW 3
020204703



MORTAR BARREL BOTTOM
020204706



MORTAR BARREL TOP
020204705

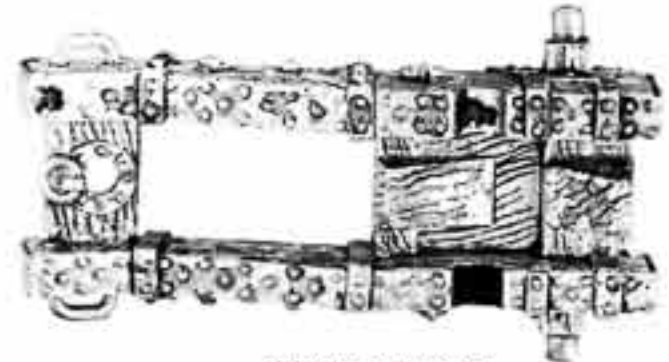

MORTAR CHASSIS
020204704

THE IMPERIAL MORTAR CONSISTS OF:

- 1 x MORTAR CREW 1
- 1 x MORTAR CREW 2
- 1 x MORTAR CREW 3
- 1 x MORTAR CHASSIS
- 1 x MORTAR BARREL TOP
- 1 x MORTAR BARREL BOTTOM
- 2 x PLASTIC SPOKED WHEELS



IMPERIAL MORTAR



PLASTIC SPOKED WHEEL
100557

IMPERIAL GREAT CANNON



GREAT CANNON CREW 1
020203701



GREAT CANNON CREW 3
020203702



GREAT CANNON CREW 2
020203703



SOLID PLASTIC WHEEL
100558



GREAT CANNON BARREL
020203705



GREAT CANNON POWDER CHEST
020203706



GREAT CANNON AXLE
020203707

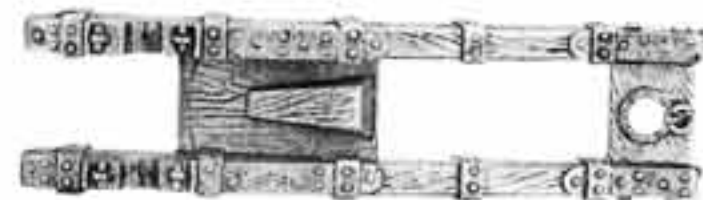

GREAT CANNON GUN CARRIAGE
020203704



GREAT CANNON

THE IMPERIAL GREAT CANNON CONSISTS OF:

- 1 x GREAT CANNON CREW 1
- 1 x GREAT CANNON CREW 2
- 1 x GREAT CANNON CREW 3
- 1 x GREAT CANNON GUN CARRIAGE
- 1 x GREAT CANNON BARREL
- 1 x GREAT CANNON AXLE
- 1 x GREAT CANNON POWDER CHEST
- 2 x SOLID PLASTIC WHEELS

EMPIRE

IMPERIAL VOLLEY GUN

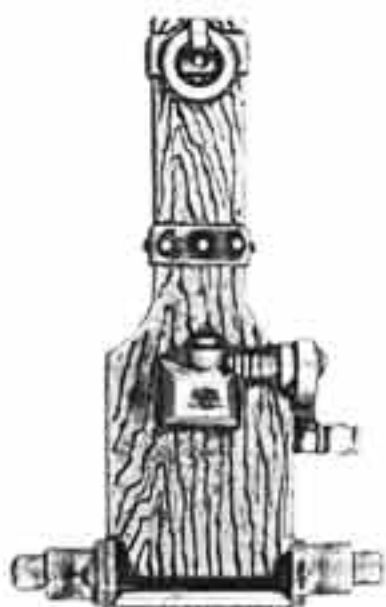

VOLLEY GUN CARRIAGE
020203007



VOLLEY GUN GUNNER CAPTAIN
WITH TELESCOPE
020203001



VOLLEY GUN
ENGINEER LEONARDO
020203002



VOLLEY GUN GUNNER
WITH POWDER KEG
020203003



VOLLEY GUN
HANDLE
020203008



PLASTIC WHEEL
100558



VOLLEY GUN
MECHANISM
020203006

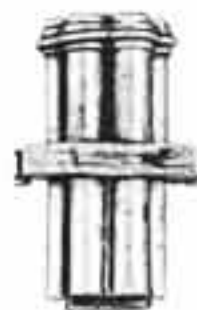

LOWER VOLLEY GUN
BARRELS
020203004



UPPER VOLLEY GUN
BARRELS
020203005

A COMPLETED EMPIRE VOLLEY GUN CONSISTS OF :

- 1 x VOLLEY GUN CARRIAGE
- 1 x UPPER VOLLEY GUN BARRELS
- 1 x LOWER VOLLEY GUN BARRELS
- 1 x VOLLEY GUN MECHANISM
- 1 x VOLLEY GUN HANDLE
- 2 x PLASTIC WHEELS
- 1 x ENGINEER LEONARDO
- 1 x GUNNER CAPTAIN WITH TELESCOPE
- 1 x GUNNER WITH POWDER KEG

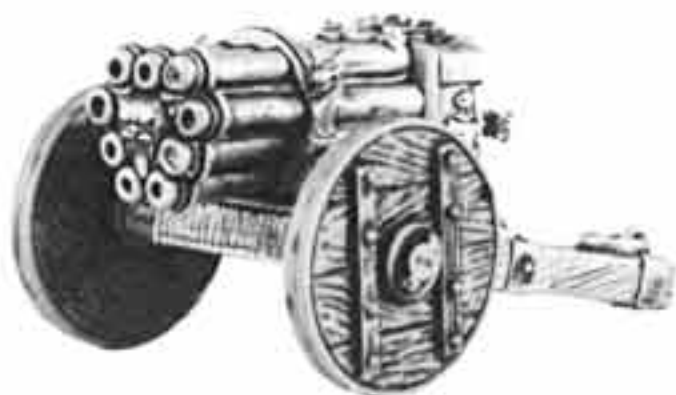

IMPERIAL VOLLEY GUN

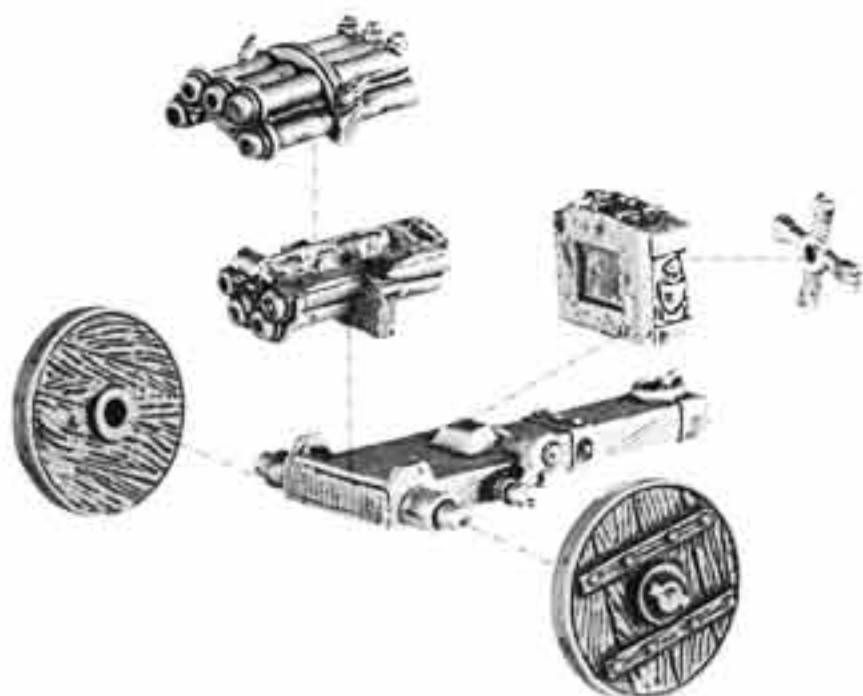

Designed by Norman Swales and Alan Perry

Not suitable for children under 36 months due to small parts and essential pointed components. All models supplied unpainted.
© Copyright Games Workshop Ltd., 1997. All rights reserved.

EMPIRE

IMPERIAL STEAM TANK

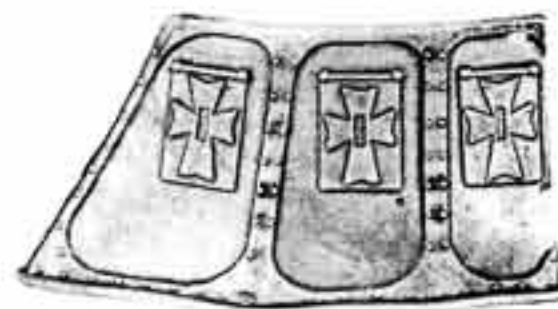

STEAM TANK LEFT SIDE ARMOUR
020204202

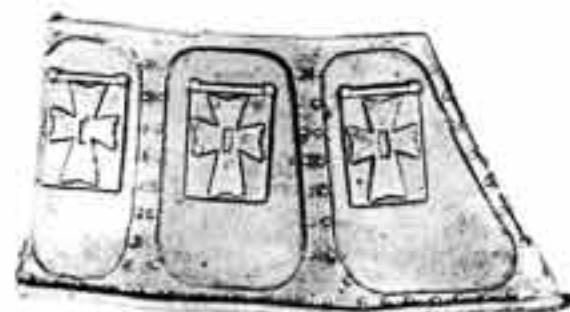

STEAM TANK RIGHT SIDE ARMOUR
020204203

IMPERIAL STEAM TANK

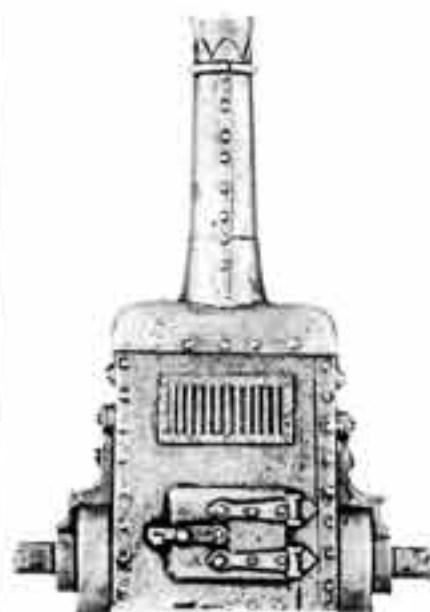

STEAM TANK BOILER
020204208



STEAM TANK BASE
020204201



STEAM TANK ENGINE
020204207



STEAM TANK BACK PLATE
020204206



STEAM TANK HATCH
020204205



STEAM TANK COMMANDER
020204211



STEAM TANK ROOF
020204204



STEAM TANK CANNON
020204210



STEAM TANK FRONT ARMOUR
020204209

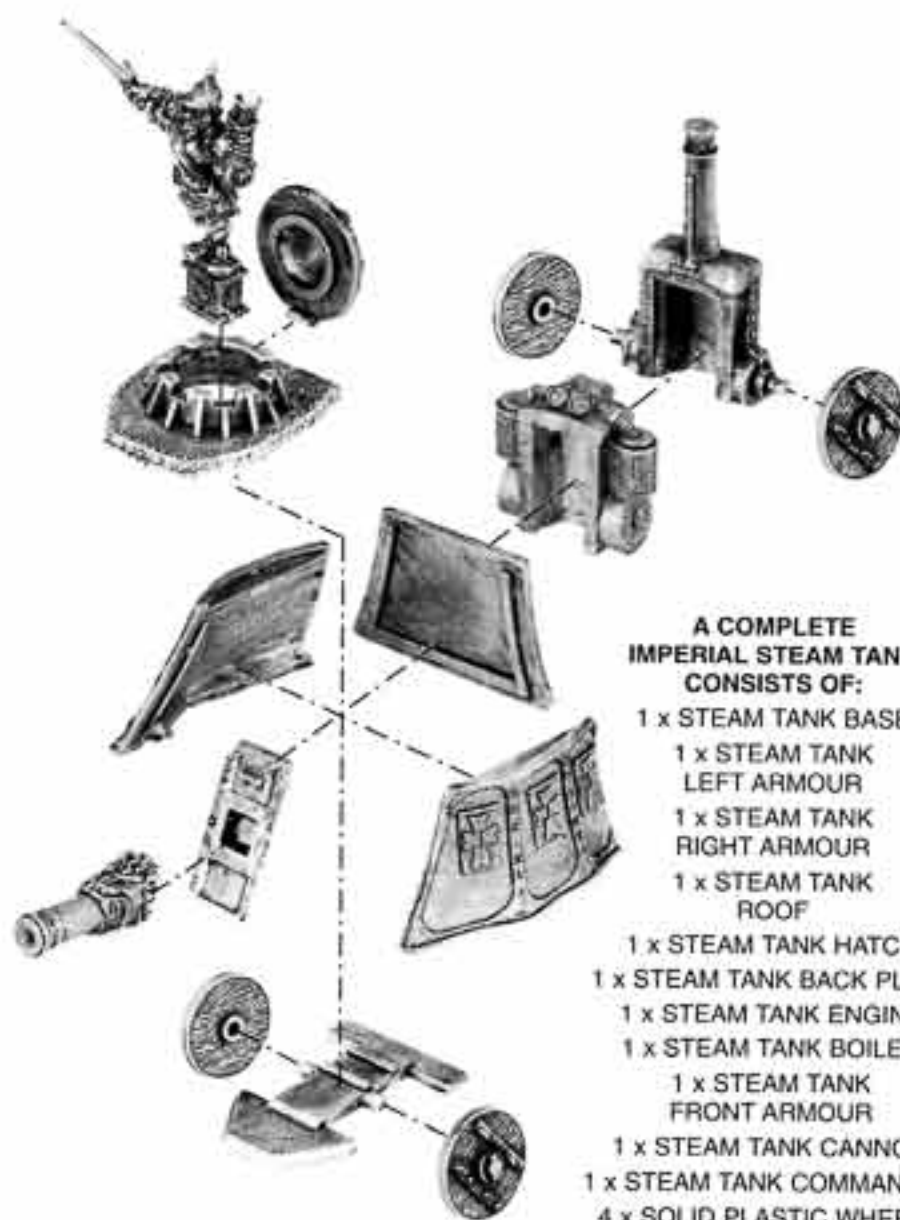

**A COMPLETE
IMPERIAL STEAM TANK
CONSISTS OF:**

- 1 x STEAM TANK BASE
- 1 x STEAM TANK LEFT ARMOUR
- 1 x STEAM TANK RIGHT ARMOUR
- 1 x STEAM TANK ROOF
- 1 x STEAM TANK HATCH
- 1 x STEAM TANK BACK PLATE
- 1 x STEAM TANK ENGINE
- 1 x STEAM TANK BOILER
- 1 x STEAM TANK FRONT ARMOUR
- 1 x STEAM TANK CANNON
- 1 x STEAM TANK COMMANDER
- 4 x SOLID PLASTIC WHEELS



EMPIRE

IMPERIAL WAR WAGON

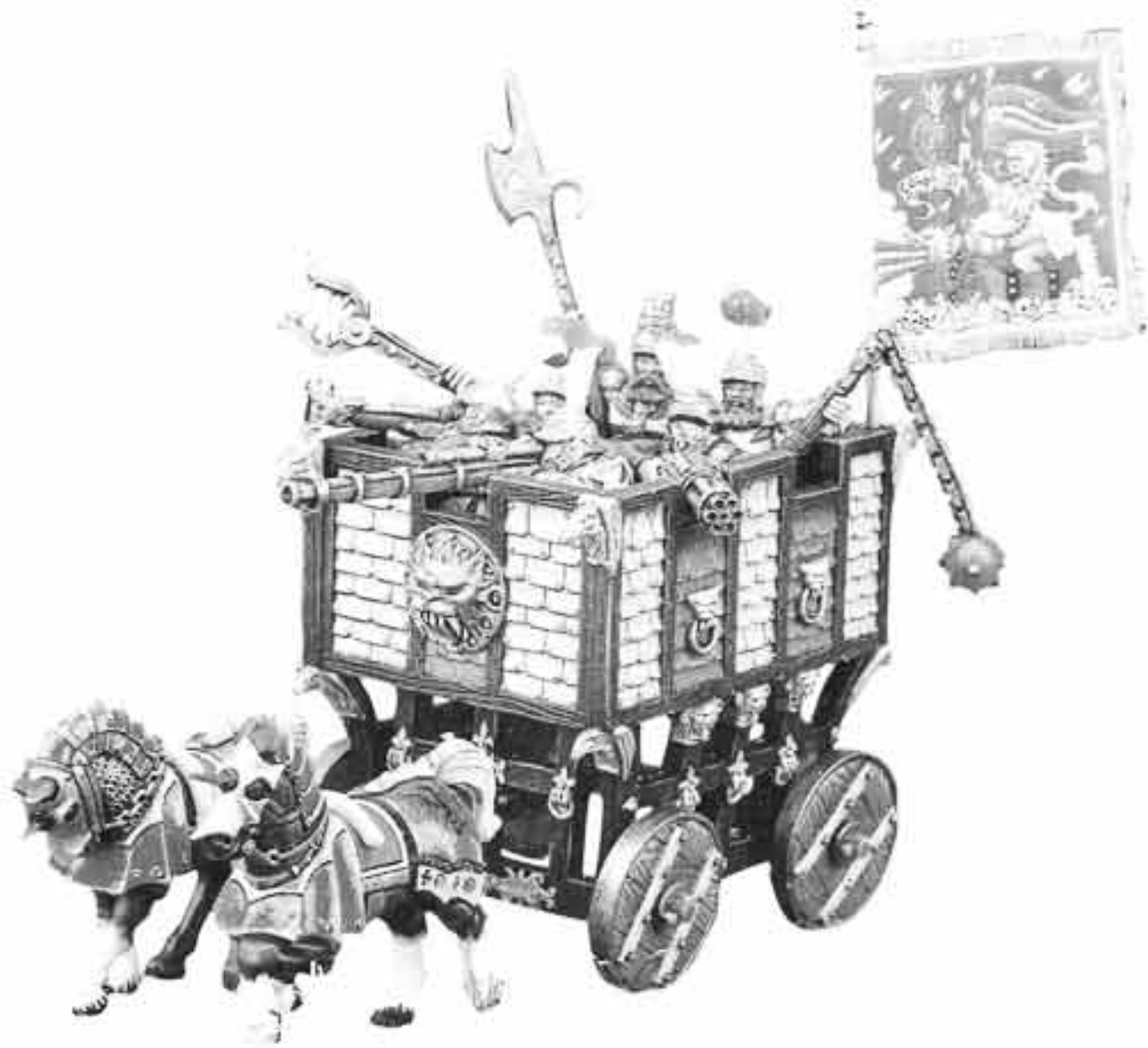

IMPERIAL WAR WAGON



WAR WAGON CREW MEMBER
WITH HOCHLAND LONG RIFLE
020204107



WAR WAGON CREW MEMBER
WITH REPEATING MUSKET
020204108



WAR WAGON CREW MEMBER
WITH BLUNDERBUSS
020204109



WAR WAGON CREW MEMBER
WITH MAN CATCHER
020204110



WAR WAGON CREW MEMBER
WITH BALL AND CHAIN
020204111



WAR WAGON CREW MEMBER
WITH HOOK HALBERD
020204112



Designed by Norman Swales and Michael Perry

Not suitable for children under 8 years due to small parts and essential pointed components. All models supplied unpainted.
© Copyright Games Workshop Ltd. 1998. All rights reserved.

EMPIRE

IMPERIAL WAR WAGON

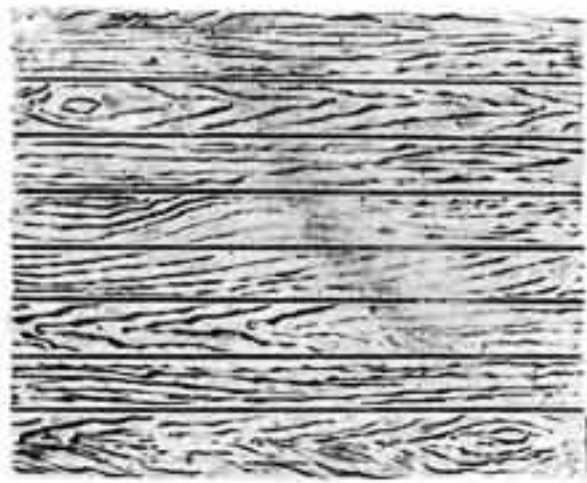

WAR WAGON DECK
020204102

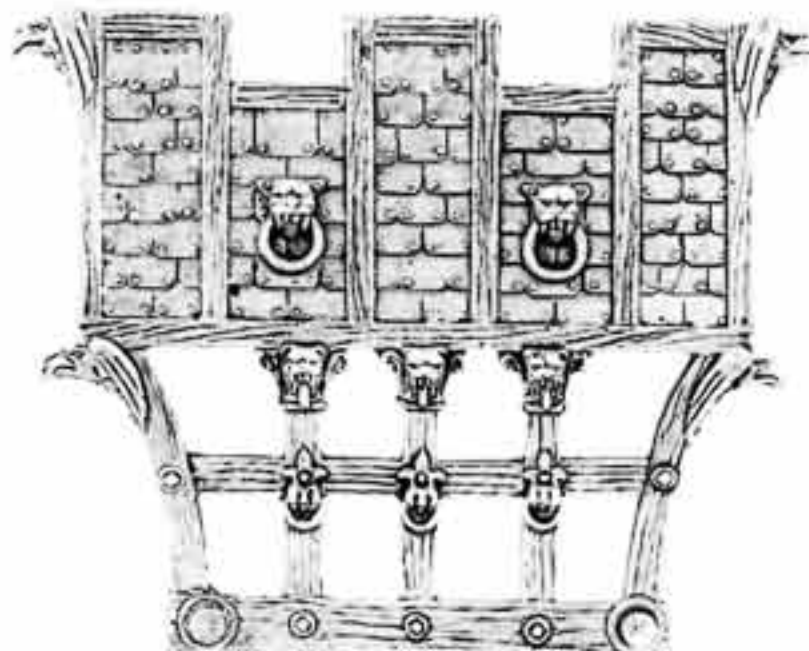

WAR WAGON RIGHT/LEFT SIDE PANEL
020204101



WAGON HAFT
020204105



WAR WAGON FRONT/REAR PANEL
020204103



PLASTIC WHEEL
100558

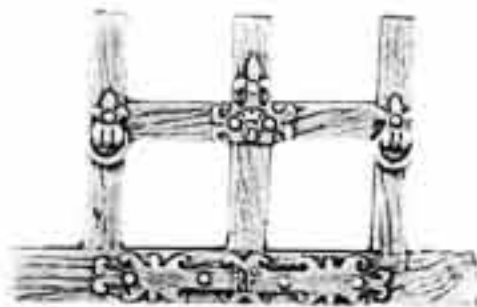

WAR WAGON FRONT/REAR FRAME
020204104



WAGON YOKE
020204106

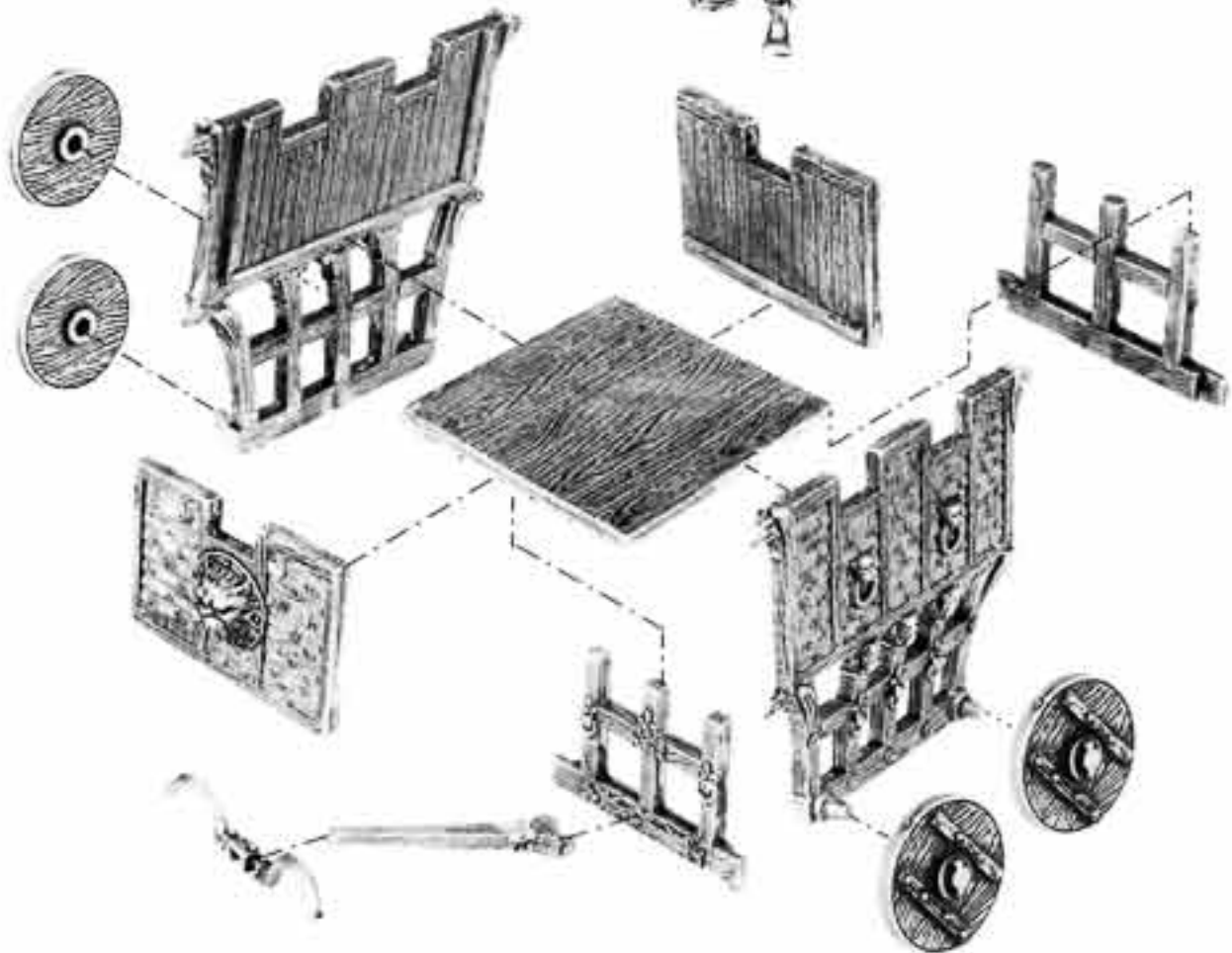

A COMPLETE IMPERIAL WAR WAGON CONSISTS OF:

- 2 x WAR WAGON RIGHT/LEFT SIDE PANELS
- 2 x WAR WAGON FRONT/REAR PANELS
- 2 x WAR WAGON FRONT/REAR FRAMES
- 1 x WAR WAGON DECK
- 1 x WAGON HAFT
- 1 x WAGON YOKE
- 4 x SOLID PLASTIC WHEELS
- 1 x CREWMAN WITH MAN CATCHER
- 1 x CREWMAN WITH HOOK HALBERD
- 1 x CREWMAN WITH BALL AND CHAIN
- 1 x CREWMAN WITH HOCHLAND LONG RIFLE
- 1 x CREWMAN WITH BLUNDERBUSS
- 1 x CREWMAN WITH REPEATING MUSKET
- 2 x ARMoured PLASTIC HORSES

EMPIRE

IMPERIAL WAR ALTAR



WAR ALTAR GRAND THEOGONIST
020204301



WAR ALTAR BASE
020204302



WAR ALTAR HORN OF SIGISMUND
020204305



WAGON HAFT
020204105



WAR ALTAR GRAND THEOGONIST
020204301



WAR ALTAR SHRINE OF SIGMAR
020204303



WAGON YOKE
020204106

WAR ALTAR GRIFFON WINGS
020204308



SOLID PLASTIC WHEEL
100558



WAR ALTAR AXLE
020204304



WAR ALTAR GRIFFON
020204306



WAR ALTAR GRIFFON TAIL
020204307

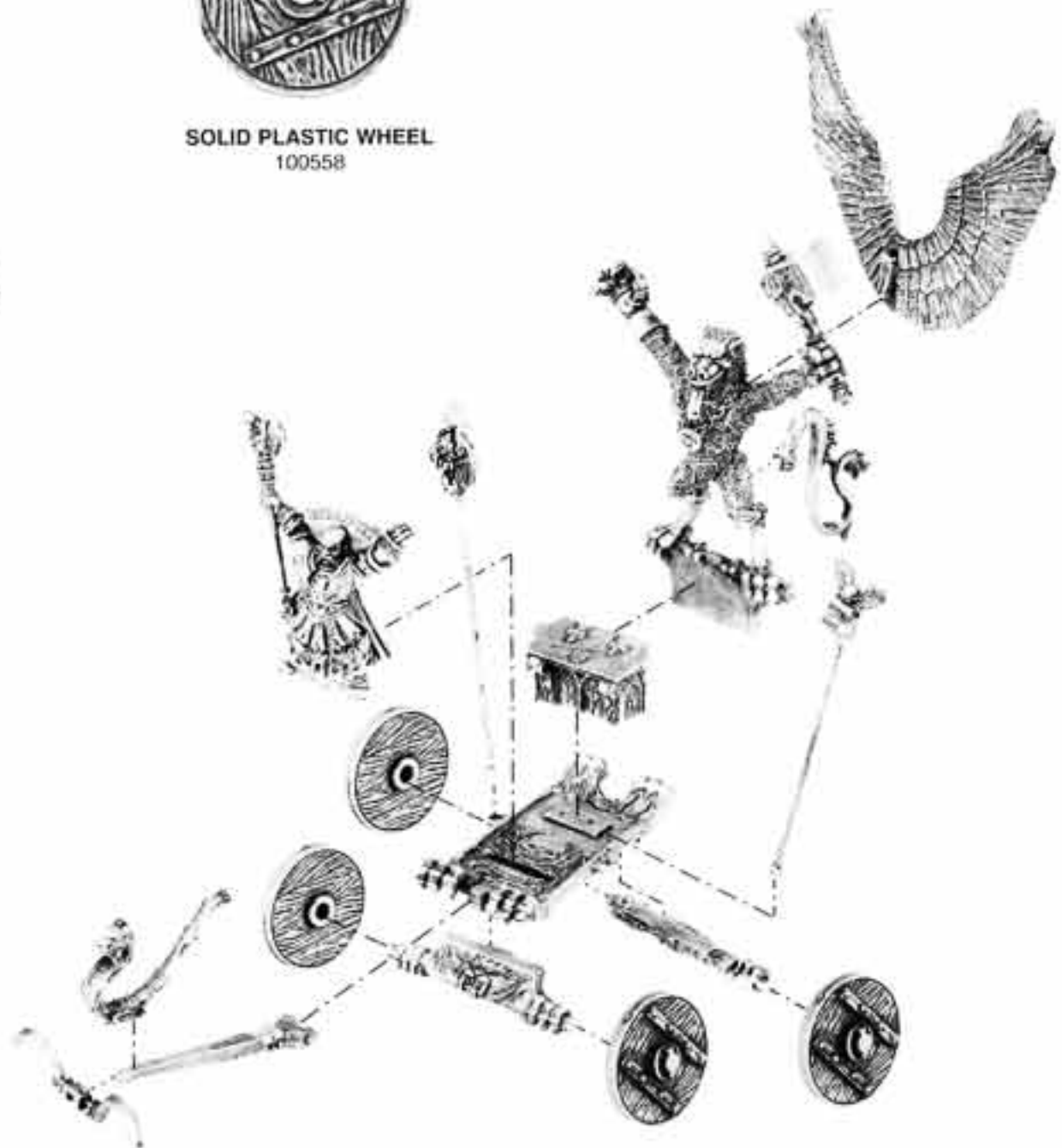

Designed by Michael Perry

EMPIRE

IMPERIAL WAR ALTAR

A COMPLETE IMPERIAL WAR ALTAR CONSISTS OF:

- 1 x WAR ALTAR GRAND THEOGONIST
- 1 x WAR ALTAR BASE
- 1 x WAR ALTAR SHRINE OF SIGMAR
- 2 x WAR ALTAR AXLES
- 1 x WAR ALTAR HORN OF SIGISMUND
- 1 x WAR ALTAR GRIFFON
- 1 x WAR ALTAR GRIFFON TAIL
- 1 x WAR ALTAR GRIFFON WINGS
- 1 x WAGON HAFT
- 1 x WAGON YOKE
- 2 x IMPERIAL BANNER POLES
- 4 x SOLID PLASTIC WHEELS

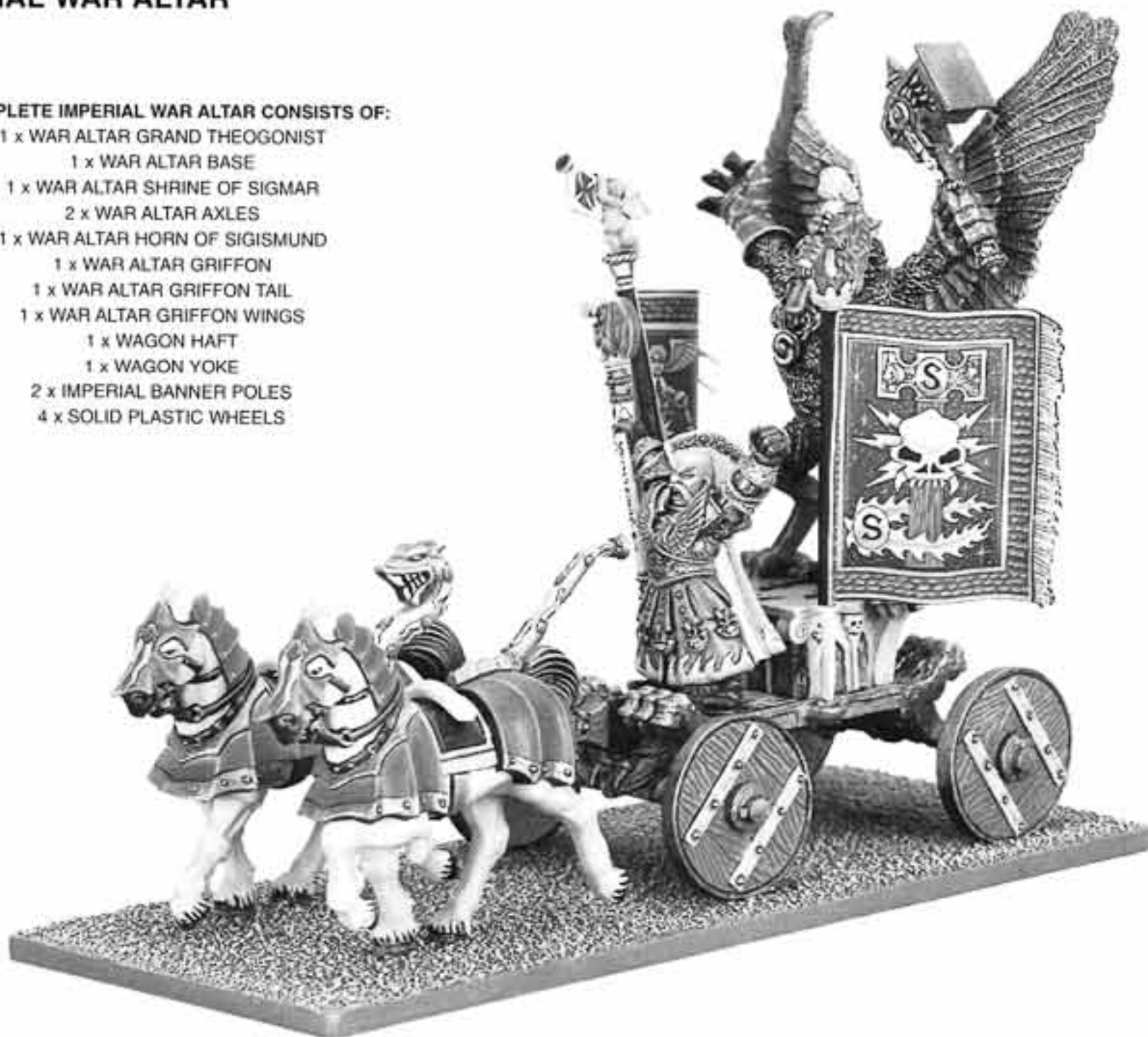

IMPERIAL WAR ALTAR

THE IMPERIAL WAR ALTAR INCLUDES TWO IMPERIAL BANNER POLES WHICH ARE SUPPLIED RANDOMLY

IMPERIAL BANNER POLES

IMPERIAL BANNER POLES
020204311



IMPERIAL BANNER POLES
020204312

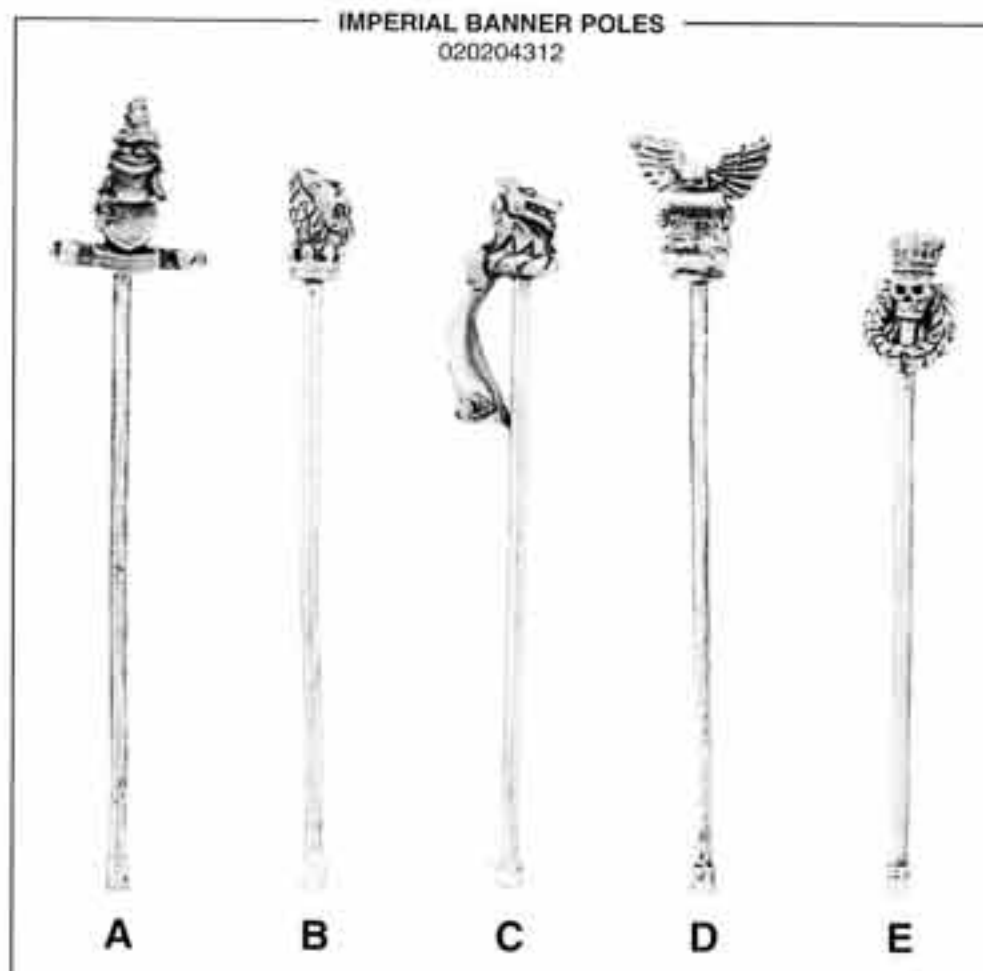

EMPIRE

EMPEROR RIDING THE GRIFFON DEATHCLAW



GRIFFON LEFT WING
020300111



GRIFFON TAIL
021000208



GRIFFON RIGHT WING
020300112



EMPEROR'S
BANNER POLE
020204402



GRIFFON BODY
RIGHT SIDE
021000205



EMPEROR KARL FRANZ
020204401

EMPEROR RIDING THE GRIFFON DEATHCLAW

A COMPLETE EMPEROR RIDING THE GRIFFON DEATHCLAW CONSISTS OF:

- 1 x GRIFFON RIGHT WING
- 1 x GRIFFON LEFT WING
- 1 x GRIFFON
BODY RIGHT SIDE
- 1 x GRIFFON RIGHT CLAW
- 1 x GRIFFON LEFT CLAW
- 1 x GRIFFON TAIL
- 1 x DEATHCLAW'S
BODY LEFT SIDE
- 1 x EMPEROR KARL FRANZ
- 1 x EMPEROR'S
BANNER POLE



DEATHCLAW'S
BODY LEFT SIDE
020204403



GRIFFON
LEFT CLAW
021000206



GRIFFON
RIGHT CLAW
021000207



Designed by Michael Perry and Trish Morrison

Not suitable for children under 36 months due to small parts and essential pointed components. All models supplied unpainted.
© Copyright Games Workshop Ltd., 1997. All rights reserved.

HIGH ELVES

PLASTIC HIGH ELF ARCHER AND SPEARMAN



HIGH ELF ARCHER AND SPEARMAN SPRUE
9999041

THE HIGH ELF ARCHER AND SPEARMAN SPRUE IS
SUPPLIED WITH ONE OF SIX SPECIALLY DESIGNED SHIELDS



HIGH ELF ARCHER



HIGH ELF SPEARMAN



ELF SHIELD SPRUE
9999002

Designed by Jes Goodwin



HIGH ELVES

SPEARMEN



HIGH ELF SPEARMAN 1
021002201



HIGH ELF SPEARMAN 2
021002202



HIGH ELF SPEARMAN 3
021002203

FRONT RANK SPEARMEN



HIGH ELF FRONT RANK
SPEARMAN 1
021006101



HIGH ELF FRONT RANK
SPEARMAN 2
021006102



HIGH ELF FRONT RANK
SPEARMAN 3
021006103



HIGH ELF FRONT RANK
SPEARMAN 4
021006104



Designed by Jes Goodwin and Gary Morley

HIGH ELVES

ARCHER COMMAND GROUP



HIGH ELF ARCHER CHAMPION
021003801



HIGH ELF ARCHER HORN BLOWER
021003702



HIGH ELF ARCHER STANDARD BEARER
021003701



ARCHERS



HIGH ELF ARCHER 1
021002701



HIGH ELF ARCHER 2
021002702



HIGH ELF ARCHER 3
021002703



HIGH ELF ARCHER 4
021002704



HIGH ELF ARCHER 5
021002705



HIGH ELF ARCHER 6
021002706



HIGH ELF ARCHER 7
021002707



HIGH ELF ARCHER 8
021002708



CITADEL
MINIATURES



CITADEL
MINIATURES

HIGH ELVES

HIGH ELF ARMoured ARCHERS



HIGH ELF ARMoured ARCHER
CHAMPION 1
021002504



HIGH ELF ARMoured ARCHER
CHAMPION 2
021002508



HIGH ELF ARMoured ARCHER
1 021000401



HIGH ELF ARMoured ARCHER
2 021000402



HIGH ELF ARMoured ARCHER 3
021000403



HIGH ELF ARMoured ARCHER 4
021000404



HIGH ELF ARMoured ARCHER 5
021000405



HIGH ELF ARMoured ARCHER 6
021006206



HIGH ELF ARMoured ARCHER 7
021006207



HIGH ELF ARMoured ARCHER 8
021006208



HIGH ELF ARMoured ARCHER 9
021006209



CITADEL
MINIATURES



CITADEL
MINIATURES

Designed by Jes Goodwin and Gary Morley

Not suitable for children under 8 years due to small parts and essential pointed components. All models supplied unpainted.
© Copyright Games Workshop Ltd. 1998. All rights reserved.

HIGH ELVES

LOTHERN SEA GUARD COMMAND



LOTHERN SEA GUARD
CHAMPION
0201005901



LOTHERN SEA GUARD
STANDARD BEARER
0201005801



LOTHERN SEA GUARD
HORN BLOWER
0201005802

LOTHERN SEA GUARD COMMAND



LOTHERN SEA
GUARDQUIVER 1
0201005902



LOTHERN SEA
GUARD QUIVER 2
0201005903



LOTHERN SEA
GUARD QUIVER 3
0201005904



LOTHERN SEA
GUARD QUIVER 4
0201005905



LOTHERN SEA
GUARD QUIVER 6
0201005907



LOTHERN SEA
GUARD 1
0201005701



LOTHERN SEA
GUARD 2
0201005702



LOTHERN SEA
GUARD 3
0201005703



LOTHERN SEA
GUARD 4
0201005704



LOTHERN SEA
GUARD 5
0201005705



LOTHERN SEA
GUARD QUIVER 5
0201005906



LOTHERN SEA
GUARD 6
0201005706



LOTHERN SEA
GUARD 7
0201005707



LOTHERN SEA
GUARD 8
0201005708



LOTHERN SEA
GUARD 9
0201005709



HIGH ELVES

PHOENIX GUARD



PHOENIX GUARD 1
021001101



PHOENIX GUARD 2
021001102



PHOENIX GUARD 3
021001103



PHOENIX GUARD 4
021001104

HIGH ELF HEROES



HIGH ELF HERO 1
079901901



HIGH ELF HERO 2
021006302

HIGH ELF HERO 2 COMES WITH A PLASTIC ELF SHIELD AS STANDARD



Designed by Jes Goodwin. High Elf Hero 2 designed by Chris Fitzpatrick

Not suitable for children under 8 years due to small parts and essential pointed components. All models supplied unpainted.
© Copyright Games Workshop Ltd. 1998. All rights reserved.

HIGH ELVES

SWORDMASTERS OF HOETH COMMAND



SWORDMASTER OF HOETH
STANDARD BEARER
021005101



SWORDMASTER OF HOETH
HORN BLOWER
021005102

SWORDMASTERS OF HOETH CHAMPION



SWORDMASTER OF HOETH
CHAMPION
021005001

SWORDMASTERS OF HOETH



SWORDMASTER
OF HOETH 1
021004901



SWORDMASTER
OF HOETH 2
021004902



SWORDMASTER
OF HOETH 3
021004903



SWORDMASTER
OF HOETH 4
021004904



SWORDMASTER
OF HOETH 5
021004905



SWORDMASTER
OF HOETH 6
021004906



SWORDMASTER
OF HOETH 7
021004907



SWORDMASTER
OF HOETH 8
021004908



SWORDMASTER
OF HOETH 9
021004909

HIGH ELVES

KORHIL, HUNTER CAPTAIN OF THE WHITE LIONS

A COMPLETE KORHIL, HUNTER CAPTAIN OF THE WHITE LIONS CONSISTS OF:
 1 x KORHIL'S BODY
 1 x KORHIL'S AXE
 1 x KORHIL'S CLOAK



KORHIL'S BODY
021004701



KORHIL'S CLOAK
021004703



KORHIL'S AXE
021004702



KORHIL, HUNTER CAPTAIN OF THE WHITE LIONS

WHITE LIONS OF CHRACE COMMAND GROUP



WHITE LIONS OF CHRACE CHAMPION
021004401



WHITE LIONS OF CHRACE STANDARD TOP
021004502



WHITE LIONS OF CHRACE STANDARD BEARER



WHITE LIONS OF CHRACE HORN BLOWER
021004503



WHITE LIONS OF CHRACE STANDARD BEARER BODY
021004501

A COMPLETE WHITE LIONS OF CHRACE STANDARD BEARER CONSISTS OF:
 1 x WHITE LIONS OF CHRACE STANDARD BEARER BODY
 1 x WHITE LIONS OF CHRACE STANDARD TOP

WHITE LIONS OF CHRACE



WHITE LION OF CHRACE 1
021004001



WHITE LION OF CHRACE 2
021004002



WHITE LION OF CHRACE 3
021004003



WHITE LION OF CHRACE 4
021004004



WHITE LION OF CHRACE 5
021004005



WHITE LION OF CHRACE 6
021004006



WHITE LION OF CHRACE 7
021004007



WHITE LION OF CHRACE 8
021004008



Designed by Gary Morley

HIGH ELVES

ELLYRIAN REAVERS COMMAND GROUP



ELLYRIAN REAVER CHAMPION
BODY
021003301



ELLYRIAN REAVER HORNBLOWER
BODY
021003401



ELLYRIAN REAVER STANDARD BEARER
BODY
021003201



ELLYRIAN REAVER LEGS 1
021002603



ELLYRIAN REAVER LEGS 2
021002604



ELLYRIAN REAVER LEGS 3
021003207

QUIVER SPRUE
021002605



ELLYRIAN REAVER
BOW AND QUIVER



ELLYRIAN REAVER
QUIVER

A COMPLETE ELLYRIAN REAVER
CHAMPION CONSISTS OF:
1 x ELLYRIAN REAVER CHAMPION BODY
1 x ELLYRIAN REAVER LEGS
1 x ELLYRIAN REAVER BOW AND QUIVER
1 x PLASTIC BARDED ELVEN STEED

A COMPLETE ELLYRIAN REAVER
STANDARD BEARER CONSISTS OF:
1 x ELLYRIAN REAVER
STANDARD BEARER BODY
1 x ELLYRIAN REAVER LEGS
1 x ELLYRIAN REAVER BOW AND QUIVER
1 x PLASTIC BARDED ELVEN STEED

A COMPLETE ELLYRIAN REAVER
HORNBLOWER CONSISTS OF:
1 x ELLYRIAN REAVER HORNBLOWER BODY
1 x ELLYRIAN REAVER LEGS
1 x ELLYRIAN REAVER QUIVER
1 x PLASTIC BARDED ELVEN STEED



ELLYRIAN REAVER CHAMPION



ELLYRIAN REAVER STANDARD BEARER

HIGH ELVES

ELLYRIAN REAVERS



ELLYRIAN REAVER BODY 1
021002601



ELLYRIAN REAVER BODY 2
021002602



ELLYRIAN REAVER WITH BOW
BODY 1
021003508



ELLYRIAN REAVER WITH BOW
BODY 2
021003509



ELLYRIAN REAVER LEGS 1
021002603



ELLYRIAN REAVER LEGS 2
021002604



ELLYRIAN REAVER LEGS 3
021003207

SPEAR SPRUE
021002606



SPEAR 1



SPEAR 2

QUIVER SPRUE
021002605



ELLYRIAN REAVER
BOW AND QUIVER



ELLYRIAN REAVER
QUIVER

BOW ARM SPRUE
021002610



ELLYRIAN REAVER
BOW



ELLYRIAN REAVER
QUIVER 2

A COMPLETE ELLYRIAN REAVER WITH BOW CONSISTS OF:
1 x ELLYRIAN REAVER BODY OR ELLYRIAN REAVER WITH BOW BODY
1 x ELLYRIAN REAVER LEGS
1 x ELLYRIAN REAVER QUIVER
1 x PLASTIC ELVEN HORSE SPRUE
1 x PLASTIC ELF SHIELD

PLEASE NOTE!

ELLYRIAN REAVER BODY GOES WITH BOW ARM SPRUE.
ELLYRIAN REAVER WITH BOW BODY GOES WITH QUIVER SPRUE.

A COMPLETE ELLYRIAN REAVER WITH
SPEAR CONSISTS OF:
1 x ELLYRIAN REAVER BODY
1 x ELLYRIAN REAVER LEGS
1 x ELLYRIAN REAVER BOW AND QUIVER
1 x SPEAR
1 x PLASTIC ELVEN HORSE SPRUE
1 x PLASTIC ELF SHIELD



ELLYRIAN REAVER WITH BOW



ELLYRIAN REAVER WITH SPEAR



CITADEL
MINIATURES



CITADEL
MINIATURES

Designed by Gary Morley

403

Not suitable for children under 36 months due to small parts and essential pointed components. All models supplied unpainted.
© Copyright Games Workshop Ltd., 1997. All rights reserved.

HIGH ELVES

SILVER HELM KNIGHTS



SILVER HELM KNIGHT BODY 1
021002803



SILVER HELM KNIGHT BODY 2
021002804



SILVER HELM KNIGHT BODY 3
021002805



SILVER HELM KNIGHT BODY 4
021002806



SILVER HELM KNIGHT LEGS 1
021002801



SILVER HELM KNIGHT LEGS 2
021002802

SILVER HELM LANCE SPRUE A
021002807



LANCE A1



LANCE A2

SILVER HELM LANCE SPRUE B
021002808



LANCE B1



LANCE B2



Parts from the Silver Helm Knights are interchangeable. For example, you could choose lance B1 to go with body 4 and legs 2, creating your own Silver Helm Knight combinations as we have done with these examples.

A COMPLETE SILVER HELM KNIGHT CONSISTS OF:
1 x SILVER HELM KNIGHT BODY
1 x SILVER HELM KNIGHT LEGS
1 x LANCE
1 x PLASTIC BARBED ELVEN STEED
1 x PLASTIC ELF SHIELD



SILVER HELM KNIGHTS

HIGH ELVES

SILVER HELMS COMMAND GROUP



SILVER HELMS CHAMPION
TORSO
021002901



SILVER HELMS HORNBLOWER
TORSO
021003001



SILVER HELMS STANDARD BEARER
TORSO
021003101



SILVER HELMS COMMAND
GROUP LEGS
021002902

A COMPLETE SILVER HELMS
CHAMPION CONSISTS OF:
1 x SILVER HELMS CHAMPION TORSO
1 x SILVER HELMS COMMAND GROUP LEGS
1 x PLASTIC BARDED ELVEN STEED
1 x PLASTIC ELF SHIELD

A COMPLETE SILVER HELMS
HORNBLOWER CONSISTS OF:
1 x SILVER HELMS HORNBLOWER TORSO
1 x SILVER HELMS COMMAND GROUP LEGS
1 x PLASTIC BARDED ELVEN STEED

A COMPLETE SILVER HELMS
STANDARD BEARER CONSISTS OF:
1 x SILVER HELMS STANDARD BEARER TORSO
1 x SILVER HELMS COMMAND GROUP LEGS
1 x PLASTIC BARDED ELVEN STEED
1 x PLASTIC ELF SHIELD



PLASTIC ELF SHIELD SPRUE
101635



SILVER HELMS CHAMPION



SILVER HELMS HORN BLOWER



SILVER HELMS STANDARD BEARER



Designed by Gary Morley

Not suitable for children under 36 months due to small parts and essential pointed components. All models supplied unpainted.
© Copyright Games Workshop Ltd., 1997. All rights reserved.

HIGH ELVES

DRAGON PRINCES OF CALEDOR



**DRAGON PRINCE
CHAMPION BODY**
021001205



**DRAGON PRINCE
STANDARD BEARER BODY**
021001204



**DRAGON PRINCE
BODY 1**
021001304



**DRAGON PRINCE
BODY 2**
021001305



**DRAGON PRINCE
BODY 3**
021001306



**DRAGON PRINCE
HORSE HEAD 1**
021001302



**DRAGON PRINCE
HORSE HEAD 2**
021001303



**DRAGON PRINCE
LEGS**
021001301

**A COMPLETE DRAGON PRINCE
OF CALEDOR CONSISTS OF:**
1 x DRAGON PRINCE BODY
1 x DRAGON PRINCE LEGS
1 x DRAGON PRINCE HEAD
1 x PLASTIC BARDED HORSE
1 x ELF SHIELD SPRUE



DRAGON PRINCES OF CALEDOR



ELVEN STEED

BARDED ELVEN STEED



BARDED ELVEN STEED
HEAD SPRUE 1
9999016



BARDED ELVEN STEED
HEAD SPRUE 2
9999016



BARDED ELVEN STEED BODY SPRUE 1
9999006



BARDED ELVEN STEED BODY SPRUE 2
9999006

ELVEN STEED



ELVEN STEED HEAD SPRUE 1
9999015



ELVEN STEED HEAD SPRUE 2
9999015



ELVEN STEED BODY SPRUE 1
9999005



ELVEN STEED BODY SPRUE 2
9999005



Designed by Trish Morrison

407

Not suitable for children under 8 years due to small parts and essential pointed components. All models supplied unpainted.
© Copyright Games Workshop Ltd. 1998. All rights reserved.

HIGH ELVES

HIGH ELF TIRANOC CHARIOT



HIGH ELF TIRANOC CHARIOT
BASE
021004803



HIGH ELF TIRANOC CHARIOT
BOWMAN
021004802



HIGH ELF TIRANOC CHARIOT
SPEARMAN
021004801



HIGH ELF TIRANOC CHARIOT
YOKE
021004809



HIGH ELF TIRANOC CHARIOT
FRONT
021004806



HIGH ELF TIRANOC CHARIOT
LEFT SIDE
021004804



HIGH ELF TIRANOC CHARIOT
RIGHT SIDE
021004805

HIGH ELF TIRANOC CHARIOT
ACCESSORY SPRUE
021004807



BANNER POLE



BOW AND
QUIVER



QUIVER

A COMPLETE HIGH ELF TIRANOC CHARIOT CONSISTS OF:

- 1 x HIGH ELF TIRANOC CHARIOT BASE
- 1 x HIGH ELF TIRANOC CHARIOT BOWMAN
- 1 x HIGH ELF TIRANOC CHARIOT SPEARMAN
- 1 x HIGH ELF TIRANOC CHARIOT FRONT
- 1 x HIGH ELF TIRANOC CHARIOT LEFT SIDE
- 1 x HIGH ELF TIRANOC CHARIOT RIGHT SIDE
- 1 x HIGH ELF TIRANOC CHARIOT YOKE
- 1 x HIGH ELF TIRANOC CHARIOT HAFT
- 1 x HIGH ELF TIRANOC CHARIOT ACCESSORY SPRUE
- 2 x PLASTIC ELVEN STEEDS
- 2 x PLASTIC SPOKED WHEELS



HIGH ELF TIRANOC CHARIOT HAFT
021004808



HIGH ELF TIRANOC CHARIOT



HIGH ELVES

HIGH ELF MAGES



HIGH ELF MAGE WITH
SWORD AND STAFF
021003902



HIGH ELF MAGE
WITH SWORD
021003901

HIGH ELF GENERAL



HIGH ELF GENERAL BODY
021001601



HIGH ELF GENERAL LEGS
021001602



HIGH ELF GENERAL

A COMPLETED HIGH
ELF GENERAL CONSISTS OF:
1 x HIGH ELF GENERAL BODY
1 x HIGH ELF GENERAL LEGS
1 x BARDED ELVEN STEED
1 x ELF SHIELD SPRUE

MOUNTED HEROES



HIGH ELF HERO BODY 1
021001703



HIGH ELF HERO LEGS
021001701



HIGH ELF HERO BODY 2
021001702



HIGH ELF HERO 1 ON BARDED ELF STEED

A COMPLETED HIGH ELF
HERO CONSISTS OF:
1 x HIGH ELF HERO BODY
1 x HIGH ELF HERO LEGS
1 x ELF STEED
1 x ELF SHIELD SPRUE



HIGH ELF HERO 2 ON BARDED ELF STEED



ELF SHIELD SPRUE
101635



Designed by Gary Morley

409

Not suitable for children under 8 years due to small parts and essential pointed components. All models supplied unpainted.
© Copyright Games Workshop Ltd. 1998. All rights reserved.

HIGH ELVES

PRINCE IMRIK LORD OF THE DRAGONS

A COMPLETE HIGH ELF DRAGON RIDER

CONSISTS OF:

- 1 x DRAGON HEAD
- 1 x DRAGON HORNS
- 1 x DRAGON NECK
- 1 x DRAGON BODY
- 1 x DRAGON TAIL
- 1 x DRAGON LEFT ARM
- 1 x DRAGON RIGHT ARM
- 1 x DRAGON LEFT LEG
- 1 x DRAGON RIGHT LEG
- 1 x DRAGON LEFT WING
- 1 x DRAGON RIGHT WING
- 1 x PRINCE IMRIK
- 1 x PRINCE IMRIK'S BACK BANNER
- 1 x STARBLADE LANCE
- 1 x ADHESIVE BANNER



PRINCE IMRIK LORD OF THE DRAGONS

DRAGON NECK
021002403



DRAGON HORNS
021002402



DRAGON BODY
021002404



DRAGON TAIL
021002405



DRAGON HEAD
021002401



HIGH ELVES

PRINCE IMRIK LORD OF THE DRAGONS



DRAGON LEFT LEG
021002409



DRAGON RIGHT LEG
021002408



DRAGON LEFT ARM
021002407



DRAGON RIGHT
ARM
021002406



PRINCE IMRIK
021002412

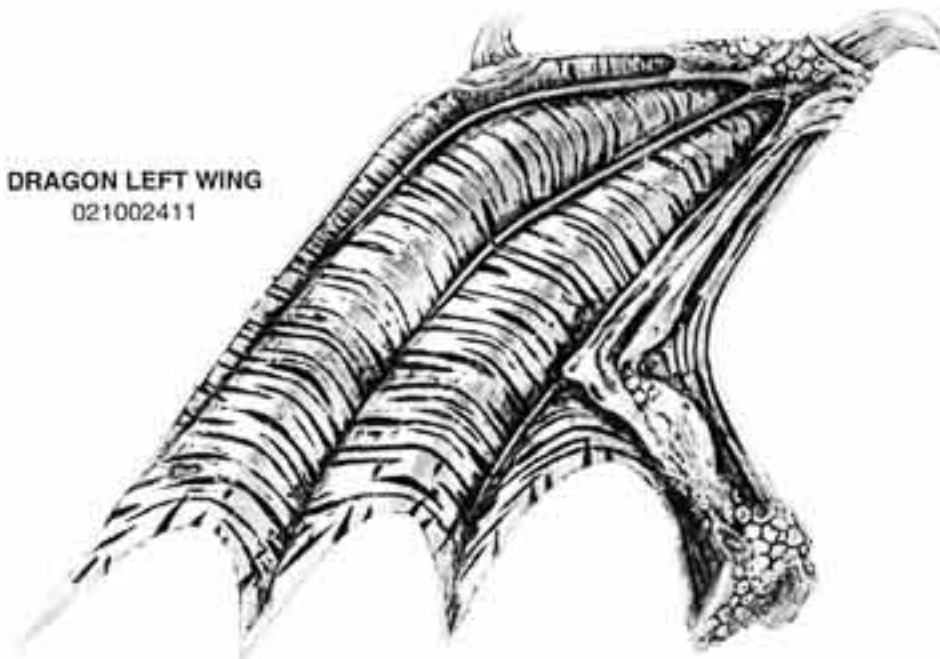

DRAGON LEFT WING
021002411

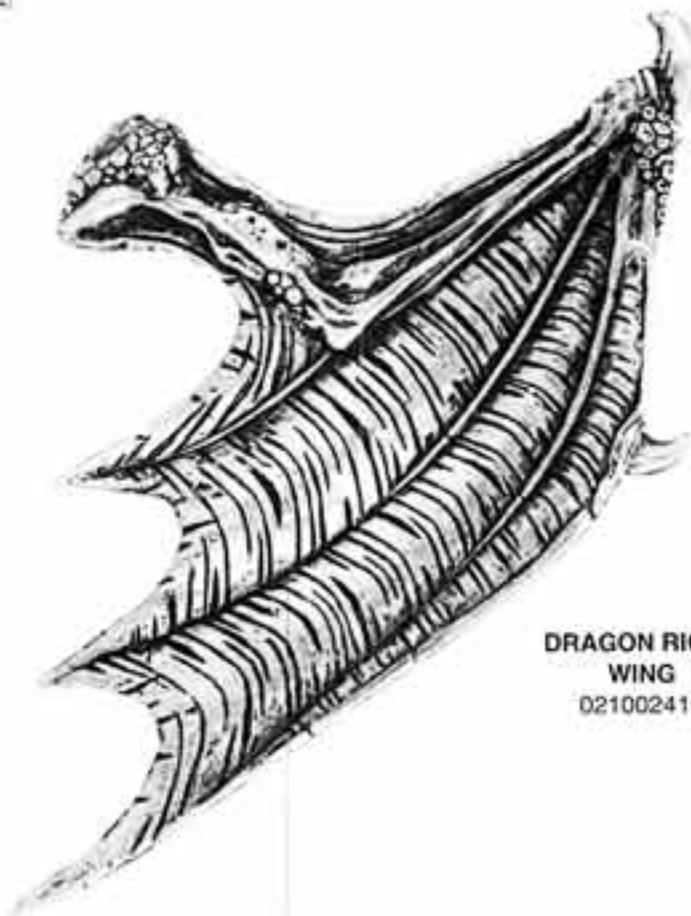

DRAGON RIGHT
WING
021002410



STARBLADE LANCE
021002413



PRINCE IMRIK'S
BACK BANNER
021002414

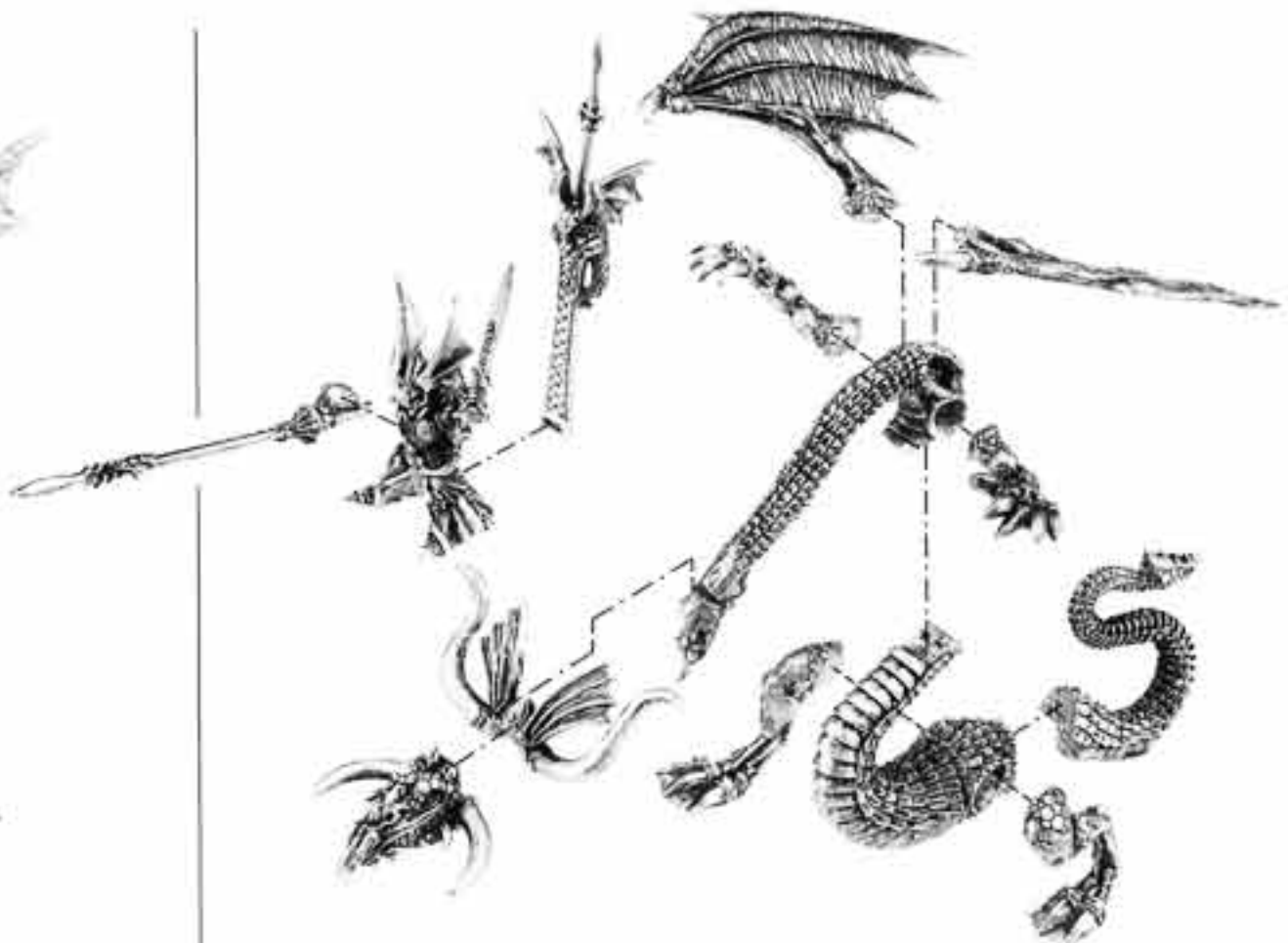

Designed by Trish Morrison and Jes Goodwin

HIGH ELVES

REPEATER BOLT THROWER



BOLT THROWER CREW 1
021000801



BOLT THROWER CREW 2
021000802

**A COMPLETED REPEATER
BOLT THROWER CONSISTS OF :**
1 x BOLT THROWER UPPER BOW
1 x BOLT THROWER LOWER BOW
1 x BOLT THROWER CREW 1
1 x BOLT THROWER CREW 2
1 x BOLT THROWER STAND
1 x BOLT THROWER LEVER



BOLT THROWER STAND
021000805



BOLT THROWER LEVER
021000806



HIGH ELF REPEATER BOLT THROWER



**BOLT THROWER
UPPER BOW**
021000804



**BOLT THROWER
LOWER BOW**
021000803

HIGH ELVES

ALARIELLE, EVERQUEEN OF AVELORN



ALARIELLE,
EVERQUEEN OF AVELORN
021005206



THE EVERQUEEN AND HER MAIDEN GUARD

MAIDEN GUARD COMMAND



MAIDEN GUARD
CHAMPION
021005301



MAIDEN GUARD
HORN BLOWER
021005207



MAIDEN GUARD
STANDARD BEARER
021005208

MAIDEN GUARD



MAIDEN GUARD 1
021005401



MAIDEN GUARD 2
021005402



MAIDEN GUARD 3
021005403



MAIDEN GUARD 4
021005404



MAIDEN GUARD 5
021005405



Designed by Gary Morley

Not suitable for children under 36 months due to small parts and essential pointed components. All models supplied unpainted.
© Copyright Games Workshop Ltd., 1997. All rights reserved.

HIGH ELVES

TYRION HIGH ELF PRINCE MOUNTED ON MALHANDIR



TYRION
HIGH ELF PRINCE
021001001

THE COMPLETE
HIGH ELF PRINCE TYRION
CONSISTS OF:
1 x TYRION HIGH ELF PRINCE
1 x ELVEN STEED MALHANDIR'S HEAD
1 x PLASTIC CAPARISON HORSE



ELVEN STEED
MALHANDIR'S HEAD
021001002



TYRION HIGH ELF PRINCE

TECLIS HIGH ELF MAGE



TECLIS HIGH ELF MAGE
021000901



HIGH ELF MAGE ON ELVEN STEED



HIGH ELF MAGE
021000601



A COMPLETE
HIGH ELF MAGE ON ELVEN STEED
CONSISTS OF:
1 x HIGH ELF MAGE
1 x PLASTIC CAPARISON HORSE



HIGH ELF MAGE ON ELVEN STEED



HIGH ELVES

ELTHARION RIDING STORMWING



GRIFFON
LEFT WING
021000209



GRIFFON
RIGHT WING
021000210



ELTHARION RIDING STORMWING



ELTHARION'S LEGS
021000202



ELTHARION'S BODY
021000201



GRIFFON LEFT
CLAW
021000207



GRIFFON RIGHT
CLAW
021000206

- THE COMPLETE ELTHARION
RIDING STORMWING
CONSISTS OF:
- 1 x ELTHARION'S BODY
 - 1 x ELTHARION'S LEGS
 - 1 x GRIFFON BODY RIGHT SIDE
 - 1 x GRIFFON BODY LEFT SIDE
 - 1 x GRIFFON RIGHT WING
 - 1 x GRIFFON LEFT WING
 - 1 x GRIFFON RIGHT CLAW
 - 1 x GRIFFON LEFT CLAW
 - 1 x GRIFFON TAIL



GRIFFON TAIL
021000208



GRIFFON BODY
LEFT SIDE
021000204



GRIFFON BODY
RIGHT SIDE
021000205



Designed by Jes Goodwin

415

Not suitable for children under 36 months due to small parts and essential pointed components. All models supplied unpainted.
© Copyright Games Workshop Ltd., 1997. All rights reserved.

LIZARDMEN

SAURUS WARRIORS

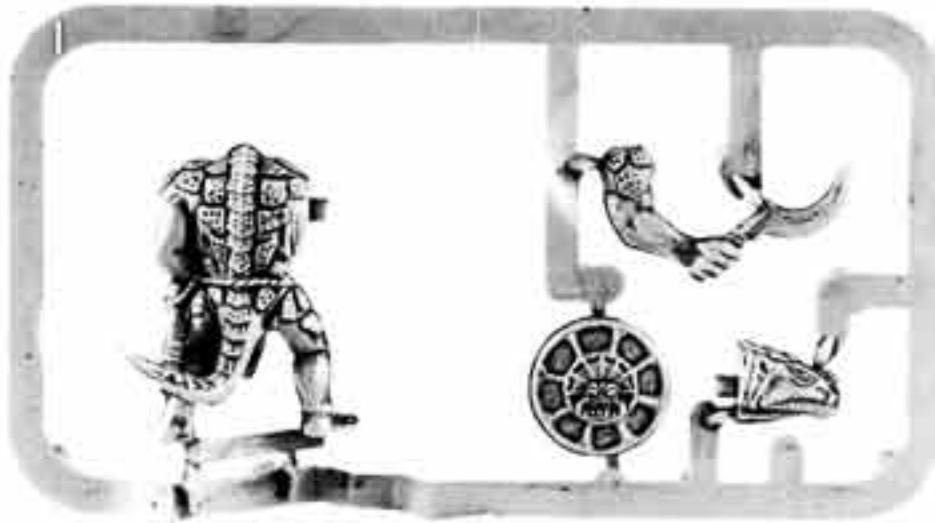

SAURUS SPRUE 1
99389999047

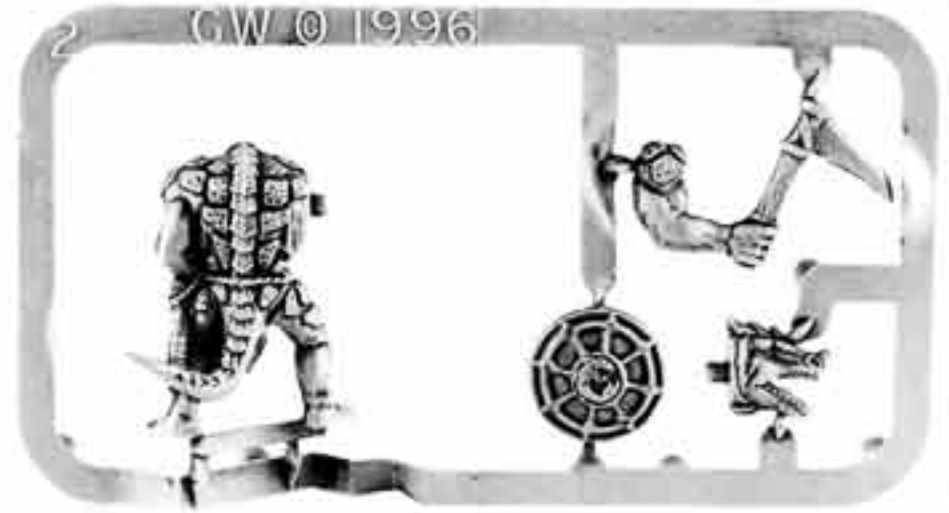

SAURUS SPRUE 2
99389999047

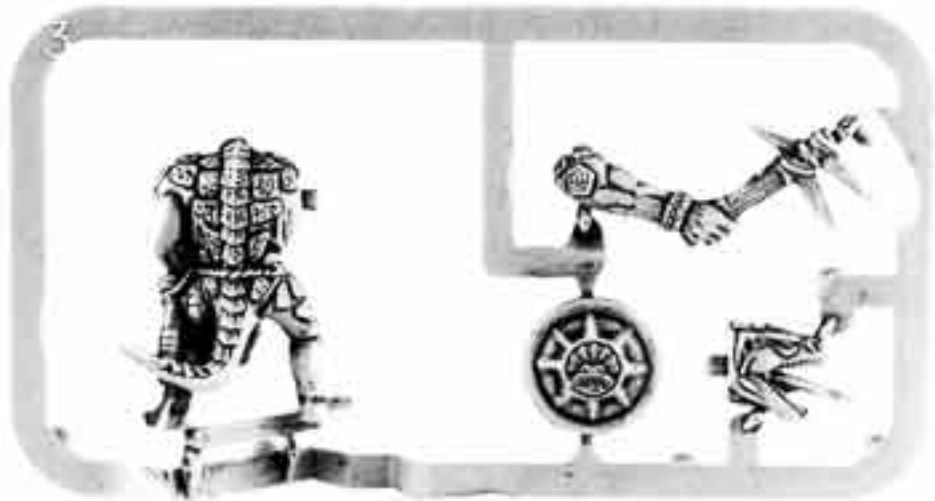

SAURUS SPRUE 3
99389999047

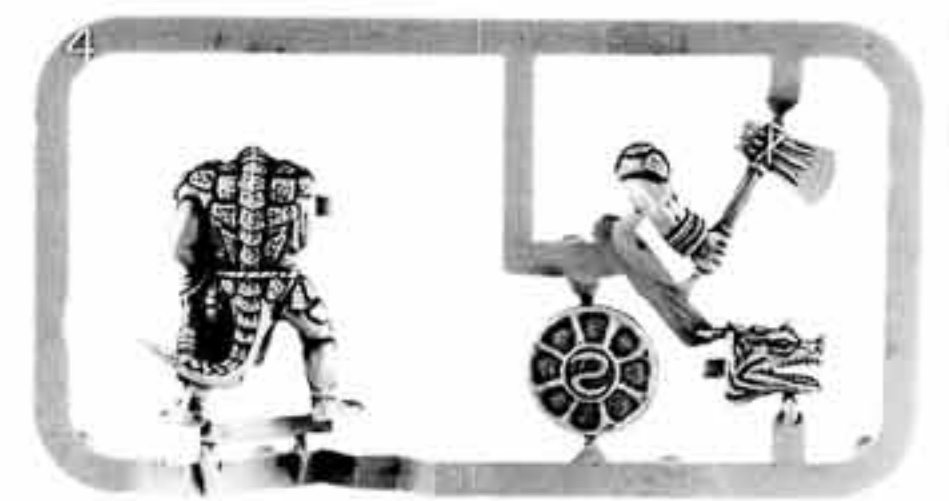

SAURUS SPRUE 4
99389999047

SPRUES SHOWN AT 90% OF NORMAL SIZE



SAURUS WARRIORS

SKINKS



SKINKS



SKINK SPRUE
99389999071



LIZARDMEN

SAURUS WARRIORS



BODY 1
020800401



BODY 2
020800402



BODY 3
020800403



BODY 4
020800404



SCYTHE
020800406



SPIKE
020800405



PICK
020800407



SPIKE 2
020800408

A COMPLETE SAURUS
WARRIOR CONSISTS OF:
1 x BODY
1 x ARM
1 x SAURUS SHIELD SPRUE



SPEAR 1
020800805



SPEAR 2
020800806



SPEAR 3
020800807



SPEAR 4
020800808



A COMPLETED SAURUS WARRIOR



SAURUS SHIELD SPRUE 1
102811



SAURUS SHIELD SPRUE 2
102811

LIZARD SWARM



LIZARD 1
020801301



LIZARD 2
020801302



LIZARD 3
020801303



LIZARD 4
020801304



LIZARD 5
020801305

A COMPLETE LIZARD
SWARM CONSISTS OF:
5 x LIZARDS



LIZARD SWARM

Saurus designed by Alan Perry, Lizard Swarm designed by Trish Morrison

Not suitable for children under 8 years due to small parts and essential pointed components. All models supplied unpainted.
© Copyright Games Workshop Ltd. 1998. All rights reserved.



LIZARDMEN

SAURUS COMMAND GROUP



SAURUS CHAMPION 1
020800501



SAURUS CHAMPION 2
020800509



SAURUS STANDARD BEARER 1
020801510



SAURUS STANDARD BEARER 2
020801504



SAURUS DRUMMER 1
020801512



SAURUS DRUMMER 2
020801507



SAURUS STANDARD
020801511



SAURUS STANDARD 2
020801505



SAURUS CHAMPION RIGHT ARM
020800503



SAURUS CHAMPION LEFT ARM
020800502



SAURUS STANDARD BEARER ARM
020801506



SAURUS MUSICIAN ARM
020801508

SAURUS COMMAND GROUP



A COMPLETED SAURUS MUSICIAN
CONSISTS OF:
1 x SAURUS MUSICIAN
1 x SAURUS MUSICIAN ARM



A COMPLETED SAURUS
CHAMPION 1 CONSISTS OF:
1 x SAURUS CHAMPION
1 x SAURUS CHAMPION RIGHT ARM
1 x SAURUS CHAMPION LEFT ARM
1 x SAURUS SHIELD SPRUE



A COMPLETED SAURUS CHAMPION
2 CONSISTS OF:
1 x SAURUS CHAMPION
1 x SAURUS CHAMPION RIGHT ARM
1 x SAURUS SHIELD SPRUE

A COMPLETED SAURUS STANDARD
BEARER CONSISTS OF:
1 x SAURUS STANDARD BEARER
1 x SAURUS STANDARD BEARER ARM
1 x SAURUS STANDARD



LIZARDMEN

SAURUS WARRIORS WITH HAND WEAPONS



SAURUS BODY 1
020800401



SAURUS BODY 2
020800402



SAURUS BODY 3
020800403



SAURUS BODY 4
020800404



SAURUS SCYTHE
020800406



SAURUS SPIKE
020800405



SAURUS PICK
020800407

A COMPLETE SAURUS
WARRIOR CONSISTS OF:
1 x SAURUS BODY
1 x SAURUS ARM
1 x SAURUS SHIELD SPRUE



SAURUS WARRIOR



SAURUS SHIELD SPRUE 1



SAURUS SHIELD SPRUE 2

LIZARDMEN

SAURUS TEMPLE GUARD



TOTEM BEARER
020801102



DRUMMER
020801101



CHAMPION
020801001



TOTEM
020801103



TEMPLE GUARD 1
020801201



TEMPLE GUARD 2
020801202



TEMPLE GUARD 3
020801203



TOTEM BEARER ARM
020801104



SAURUS DRUMMER ARM
020801508

A COMPLETED SAURUS TEMPLE GUARD DRUMMER CONSISTS OF:
1 x DRUMMER
1 x SAURUS DRUMMER ARM

A COMPLETED SAURUS TEMPLE GUARD CHAMPION CONSISTS OF:
1 x CHAMPION
1 x CHAMPION ARM 1
1 x SAURUS SHIELD SPRUE

A COMPLETED SAURUS TEMPLE GUARD TOTEM BEARER CONSISTS OF:
1 x TOTEM BEARER
1 x TOTEM BEARER ARM
1 x TOTEM

A COMPLETED SAURUS TEMPLE GUARD CONSISTS OF:
1 x TEMPLE GUARD
1 x HALBERD
1 x SAURUS SHIELD SPRUE



CHAMPION ARM 1
020801002



TEMPLE GUARD REGIMENT



HALBERD
020801204



Designed by Alan Perry

LIZARDMEN

KROXIGOR



KROXIGOR BODY 1
020800902



KROXIGOR BODY 2
020800906



KROXIGOR WEAPON ARM 1
020800903



KROXIGOR WEAPON ARM 2
020800907



KROXIGOR HEAD 1
020800901



KROXIGOR HEAD 2
020800905



KROXIGOR ARM 3
020800908



KROXIGOR TAIL 1
020800909



KROXIGOR TAIL 2
020800904

**A COMPLETED KROXIGOR 1
CONSISTS OF:**

- 1 x KROXIGOR BODY 1
- 1 x KROXIGOR WEAPON ARM 1
- 1 x KROXIGOR HEAD 1
- 1 x KROXIGOR TAIL 1

**A COMPLETED KROXIGOR 2
CONSISTS OF:**

- 1 x KROXIGOR BODY 2
- 1 x KROXIGOR WEAPON ARM 2
- 1 x KROXIGOR HEAD 2
- 1 x KROXIGOR TAIL 2
- 1 x KROXIGOR ARM 3



KROXIGOR 1



KROXIGOR 2



CITADEL
MINIATURES



CITADEL
MINIATURES

Designed by Alan Perry

Not suitable for children under 36 months due to small parts and essential pointed components. All models supplied unpainted.
© Copyright Games Workshop Ltd., 1997. All rights reserved.

LIZARDMEN™

SKINK COMMAND GROUP



SKINK CHAMPION
WITH BOW 1
020801406



SKINK CHAMPION
WITH BOW 2
020801407



SKINK CHAMPION
WITH JAVELIN 1
020800614



SKINK DRUMMER 1
020801412



SKINK DRUMMER 2
020801413



SKINK TOTEM BEARER 1
020801410



SKINK TOTEM BEARER 2
020801408



TOTEM TOP 1
020801411



TOTEM TOP 2
020801409



A COMPLETE SKINK TOTEM
BEARER CONSISTS OF:
1 x SKINK TOTEM BEARER
1 x TOTEM TOP

SKINK TOTEM BEARER

SKINKS



SKINK ARCHER 1
020800302



SKINK ARCHER 2
020800303



SKINK ARCHER 3
020800304



SKINK ARCHER 4
020800305



SKINK WITH JAVELIN 1
020800715



SKINK WITH JAVELIN 2
020800716



SKINK WITH JAVELIN 3
020800717



SKINK WITH JAVELIN 4
020800718



CITADEL
MINIATURES



CITADEL
MINIATURES

LIZARDMEN

SALAMANDER



SKINK RUNNER 1
020801705



SKINK RUNNER 2
020801706



SALAMANDER



SKINK RUNNER 3
020801707



SKINK RUNNER 4
020801708

THE COMPLETE SALAMANDER
CONSISTS OF:
1 x BODY
1 x LEG
1 x HEAD
1 x TAIL
4 x SKINK RUNNERS



BODY
020801701



HEAD
020801702



LEG
020801703



TAIL
020801704

SERPENT SWARM

A Serpent Swarm consists of
any 5 Serpents supplied with
a 40mm Monster Base



SERPENT 1
020801901



SERPENT 2
020801902



SERPENT 3
020801903



SERPENT 4
020801904



SERPENT 5
020801905



SERPENT 6
020801906



SERPENT 7
020801907



SERPENT 8
020801908



Designed by Trish Morrison and Alan Perry

LIZARDMEN

SLANN MAGE PRIEST



PALANQUIN THRONE HORN 1
020800109



PALANQUIN THRONE HORN 2
020800109



ARM
020800102



BODY
020800101



THRONE BASE
020800103



THRONE BACK
020800104



THRONE STANDARD 1
020800106



THRONE STANDARD 2
020800108



SAURUS PALANQUIN BEARER 1
020800110



SAURUS PALANQUIN BEARER 2
020800111



SAURUS PALANQUIN BEARER 3
020800113



SAURUS PALANQUIN BEARER 4
020800112



SAURUS PALANQUIN BEARER LEFT ARM 1
020800114



SAURUS PALANQUIN BEARER LEFT ARM 2
020800115



SAURUS PALANQUIN BEARER RIGHT ARM 1
020800405



SAURUS PALANQUIN BEARER RIGHT ARM 2
020800407



SAURUS PALANQUIN LEFT SUPPORT ARM
020800116



SAURUS PALANQUIN RIGHT SUPPORT ARM
020800117



CITADEL
MINIATURES



CITADEL
MINIATURES

LIZARDMEN

SLANN MAGE PRIEST

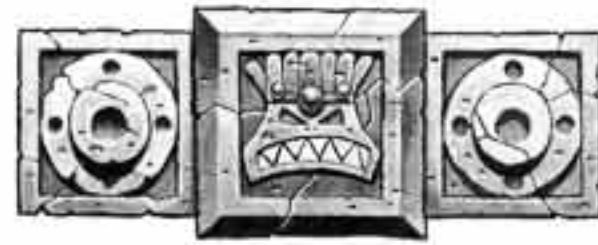

A COMPLETED SLANN MAGE PRIEST CONSISTS OF:

- 1 x BODY
- 1 x ARM
- 1 x THRONE BASE
- 1 x THRONE BACK
- 1 x THRONE STANDARD 1
- 1 x THRONE STANDARD 2
- 1 x PALANQUIN THRONE HORN 1
- 1 x PALANQUIN THRONE HORN 2
- 1 x SAURUS PALANQUIN BEARER 1
- 1 x SAURUS PALANQUIN BEARER 2
- 1 x SAURUS PALANQUIN BEARER 3
- 1 x SAURUS PALANQUIN BEARER 4
- 2 x SAURUS PALANQUIN BEARER LEFT ARMS
- 2 x SAURUS PALANQUIN BEARER RIGHT ARMS
- 1 x SAURUS PALANQUIN LEFT SUPPORT ARM
- 1 x SAURUS PALANQUIN RIGHT SUPPORT ARM

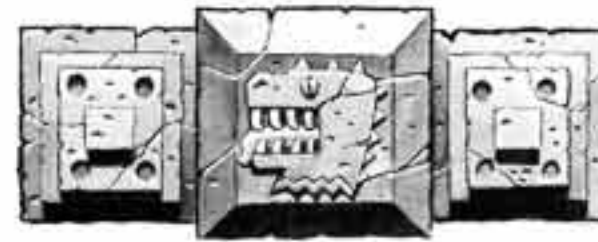

A COMPLETED SLANN MAGE PRIEST



Designed by Alan Perry

Not suitable for children under 36 months due to small parts and essential pointed components. All models supplied unpainted.
© Copyright Games Workshop Ltd., 1997. All rights reserved.

LIZARDMEN

STEGADON



HEAD
020801605



BODY LEFT SIDE
020801602



BODY RIGHT SIDE
020801601

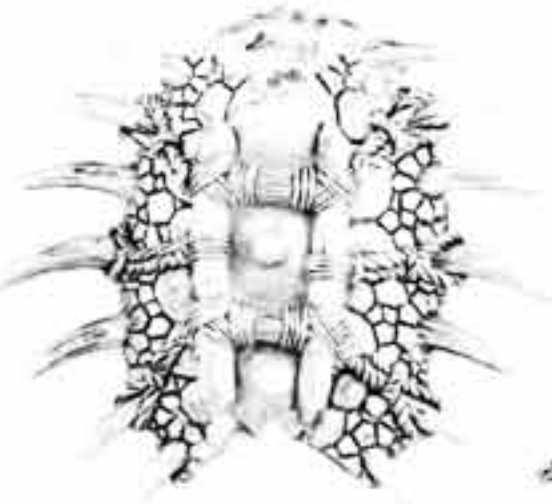

BACK PLATE
020801604



TAIL
020801607



HORN
020801616

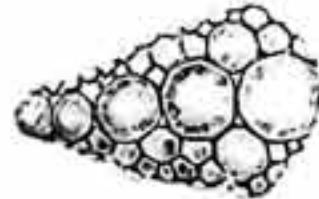

TAIL PLATE
020801606

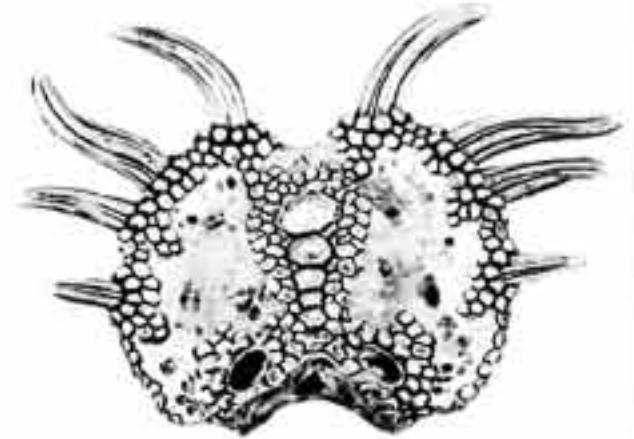

HORNY PLATE
020801603



SKINK WITH BOW 1
020801619



SKINK WITH BOW 2
020801620



SKINK CREW WITH JAVELIN
020801621



SKINK CREW WITH SPEAR
020801622



SKINK CREW FIRING GREAT BOW 1
020801623



SKINK CREW FIRING GREAT BOW 2
020801624



HOWDAH LEFT SIDE
020801609



HOWDAH RIGHT SIDE
020801610



HOWDAH BACK
020801611



SPEAR
020801618



HOWDAH BASE
020801608



GREAT BOW STAND
020801612



GREAT BOW
020801613



QUIVER 1
020801614



QUIVER 2
020801615



TOTEM
020801617



LIZARDMEN

STEGADON



THE COMPLETE STEGADON CONSISTS OF:

- 1 x HEAD
- 1 x BODY LEFT SIDE
- 1 x BODY RIGHT SIDE
- 1 x BACK PLATE
- 1 x HORNY PLATE
- 1 x TAIL
- 2 x HORNS
- 1 x TAIL PLATE
- 1 x SKINK WITH BOW 1
- 1 x SKINK WITH BOW 2
- 1 x SKINK CREW WITH JAVELIN
- 1 x SKINK CREW WITH SPEAR
- 1 x SPEAR
- 1 x SKINK CREW FIRING GREAT BOW 1
- 1 x SKINK CREW FIRING GREAT BOW 2
- 1 x TOTEM
- 1 x HOWDAH LEFT SIDE
- 1 x HOWDAH RIGHT SIDE
- 1 x HOWDAH BACK
- 1 x HOWDAH BASE
- 1 x GREAT BOW STAND
- 1 x GREAT BOW
- 1 x QUIVER 1
- 1 x QUIVER 2
- 2 x SAURUS SHIELD SPRUES

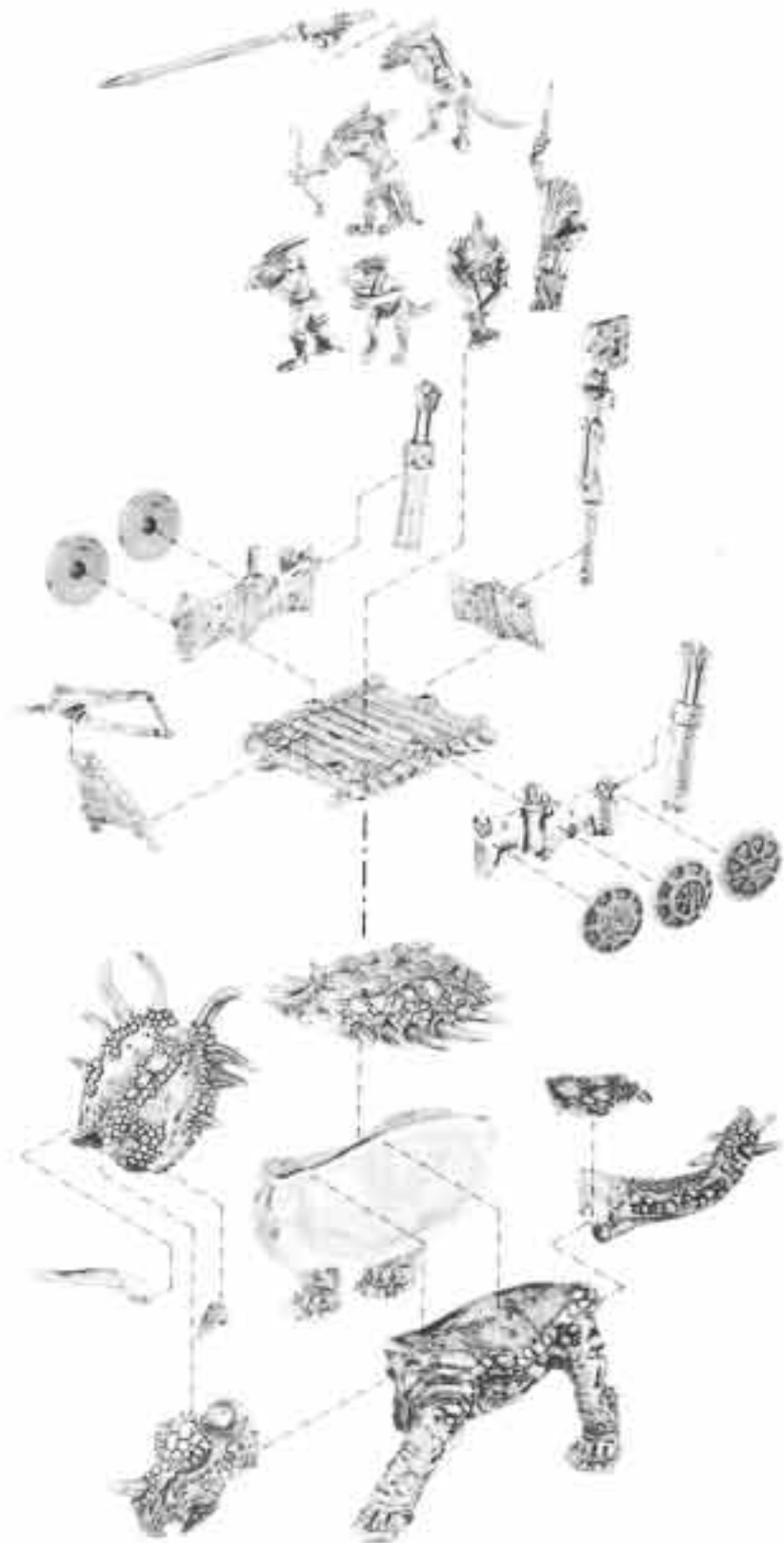

Designed by Trish Morrison and Alan Perry

Not suitable for children under 36 months due to small parts and essential pointed components. All models supplied unpainted.
© Copyright Games Workshop Ltd., 1997. All rights reserved.

LIZARDMEN

TERRADON



REAR SKINK RIDER
WITH SHORT BOW
020801814



FRONT SKINK RIDER
WITH SHORT BOW
020801813



REAR SKINK RIDER
WITH JAVELINS
020801815



FRONT SKINK RIDER
WITH JAVELINS
020801816



SHIELD
020801817



THE COMPLETED TERRADON
CONSISTS OF:
1 x HEAD
1 x TAIL
1 x LEFT WING
1 x RIGHT WING
1 x FRONT SKINK RIDER
1 x BACK SKINK RIDER
2 x SHIELDS

PLEASE NOTE:
THE HEADS, WINGS AND TAILS
ARE NOT INTERCHANGABLE

TERRADON



LEFT WING 1
020801803



RIGHT WING 1
020801804



RIGHT WING 2
020801807



LEFT WING 2
020801808



RIGHT WING 3
020801811



LEFT WING 3
020801812



HEAD 1
020801801



HEAD 2
020801805



HEAD 3
020801809

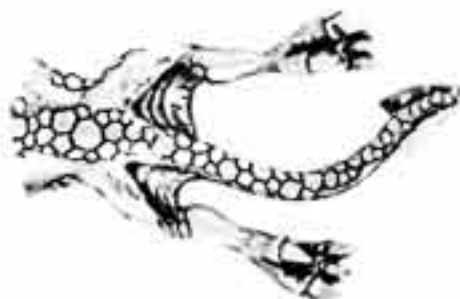

TAIL 1
020801802



TAIL 2
020801806



TAIL 3
020801810



CITADEL
MINIATURES



CITADEL
MINIATURES

WARHAMMER®

FANTASY SWARM SPRUE

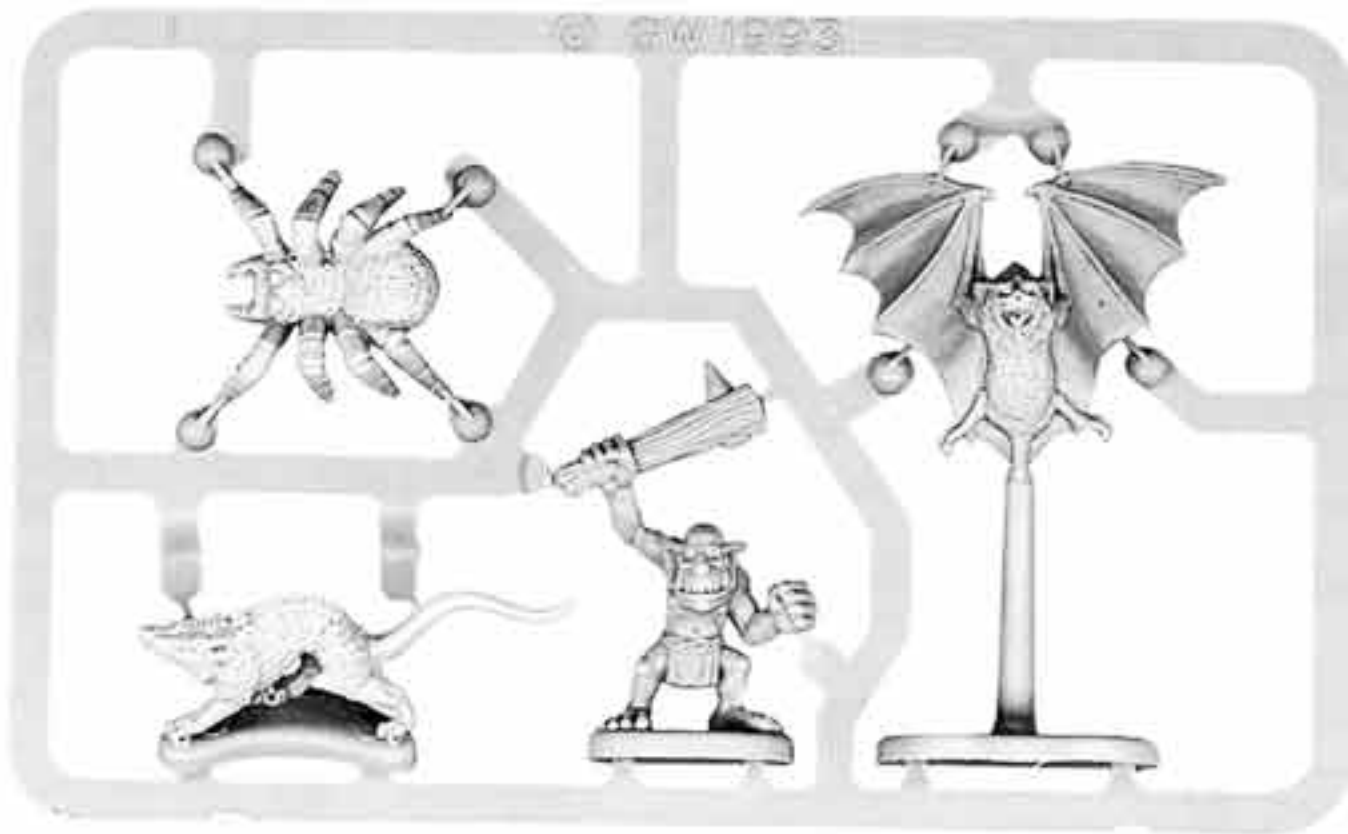

FANTASY SWARM SPRUE
020801901



BAT SWARM



SNOTLING BASE



SPIDER SWARM



RAT SWARM

FANTASY SWARM SPRUES ARE SUPPLIED IN A BOXED SET OF 5 SPRUES, THIS ALLOWS YOU TO ASSEMBLE ONE SWARM EACH OF RATS, BATS, SPIDERS AND SNOTLINGS.

Designed by Norman Swales

Not suitable for children under 8 years due to small parts and essential pointed components. All models supplied unpainted.
© Copyright Games Workshop Ltd. 1998. All rights reserved.

ORCS & GOBLINS

PLASTIC ORC WARRIOR AND ARCHER SPRUE



103239



THE PLASTIC ORC SPRUE IS SUPPLIED WITH A VARIETY OF SHIELD DESIGNS

PLASTIC GOBLIN SPEARMAN AND ARCHER SPRUE

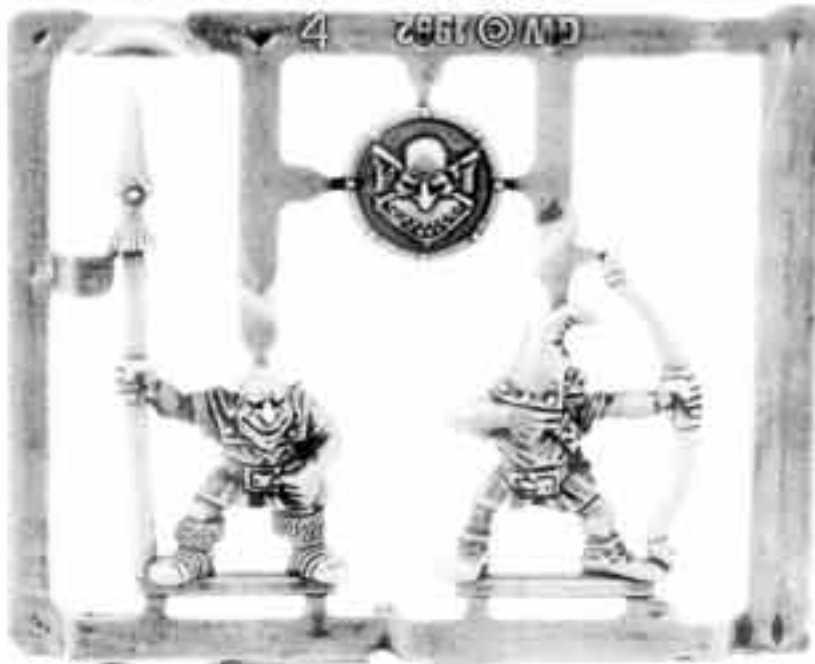

104676



THE PLASTIC GOBLIN SPRUE IS SUPPLIED WITH A VARIETY OF SHIELD DESIGNS



ORCS & GOBLINS

BLACK ORC COMMAND



BLACK ORC BOSS
020901602



BLACK ORC DRUMMER
020901505

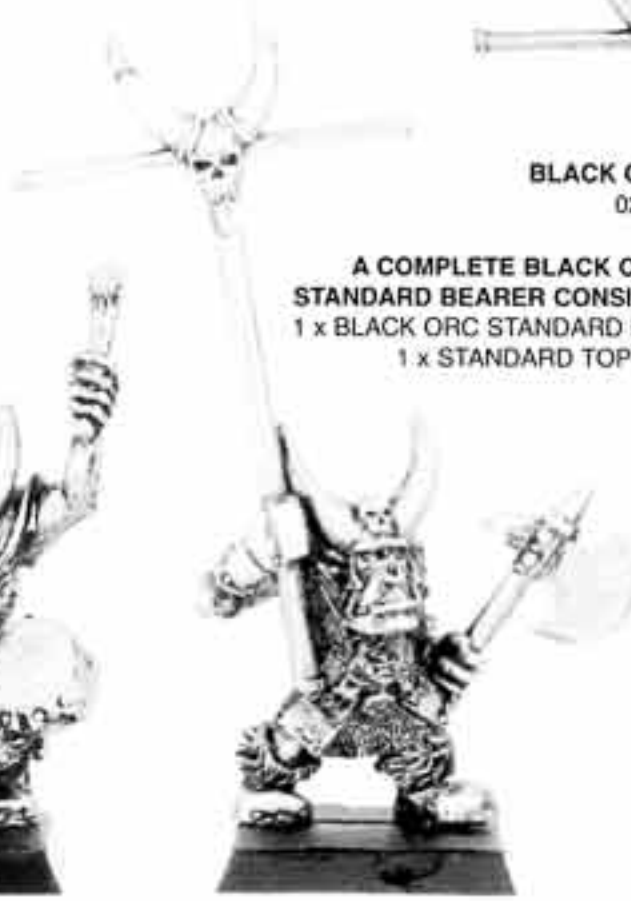

BLACK ORC STANDARD BEARER
020901503



BLACK ORC BIG BOSS
020901601



BLACK ORC STANDARD
020901504

A COMPLETE BLACK ORC
STANDARD BEARER CONSISTS OF:
1 x BLACK ORC STANDARD BEARER
1 x STANDARD TOP

BLACK ORCS



**BLACK ORC
WITH AXE 1**
020901404



**BLACK ORC
WITH AXE 3**
020901406



**BLACK ORC
WITH AXE 2**
020901405



**BLACK ORC
WITH AXE AND CLEAVER**
020901402



**BLACK ORC
WITH AXE AND SWORD**
020901401



Designed by Alan Perry

Not suitable for children under 36 months due to small parts and essential pointed components. All models supplied unpainted.
© Copyright Games Workshop Ltd., 1997. All rights reserved.

ORCS & GOBLINS

ORC BOSS



ORC BOSS
020901901

ORC BOSS IS SUPPLIED WITH A
LARGE ROUND SHIELD

ORC BIG 'UN COMMAND



BANNER BEARER
020901801

A COMPLETE BANNER
BEARER CONSISTS OF:
1 X BANNER BEARER
1 X BANNER TOP



BANNER TOP
020901802



DRUMMER
020901803

ORC BIG 'UNS WITH HAND WEAPONS



ORC BIG 'UN WITH SWORD
020901701



ORC BIG 'UN WITH AXE
020901702



ORC BIG 'UN WITH MACE
020901703

ORC BIG 'UNS ARE
SUPPLIED WITH LARGE
ROUND SHIELDS

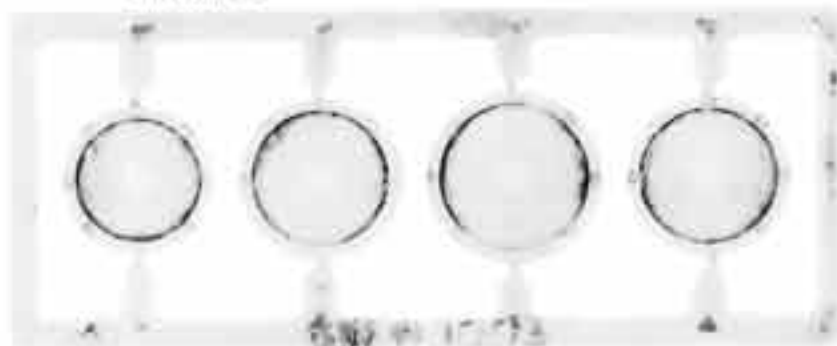

LARGE ROUND SHIELD SPRUE
111204



ORCS & GOBLINS

SAVAGE ORC BOYZ



SAVAGE ORC
WITH SPIKED CLUB 1
020904203



SAVAGE ORC
WITH STONE HAMMER 2
020904212



SAVAGE ORC WITH
STONE HAMMER 1
020904205



SAVAGE ORC
WITH CLUB
020900806



SAVAGE ORC
WITH STONE AXE 1
020904207



SAVAGE ORC
WITH STONE AXE 2
020904208



SAVAGE ORC
WITH SPIKED CLUB 3
020904211



SAVAGE ORC
WITH SPIKED CLUB 2
020904204



SAVAGE ORC
WITH STONE HAMMER 3
020904213



SAVAGE ORC
WITH STONE HAMMER 4
020904214



SAVAGE ORC
WITH STONE HAMMER 5
020904215



SAVAGE ORC
WITH STONE HAMMER 6
020904216



A COMPLETE SAVAGE ORC BOY
CONSISTS OF:
1 x SAVAGE ORC BOY
1 x PLASTIC SHIELD

SAVAGE ORC BOYZ



Designed by Alan Perry

ORCS & GOBLINS

SAVAGE ORC ARRER BOYZ



SAVAGE ORC
WITH CLUB AND BOW
020900701



SAVAGE ORC
WITH BOW 1
020900702



SAVAGE ORC
WITH BOW 2
020900703



SAVAGE ORC
WITH BOW 3
020900704



SAVAGE ORC
WITH BOW 4
020900705



SAVAGE ORC
WITH BOW 5
020900706



SAVAGE ORC
WITH BOW 6
020900707



SAVAGE ORC
WITH BOW 7
020900708



SAVAGE ORC
WITH BOW 8
020900709



SAVAGE ORC
WITH BOW 9
020900710



SAVAGE ORC
WITH BOW 10
020900711



SAVAGE ORC
WITH BOW 11
020900712



SAVAGE ORC
WITH BOW 12
020900713



SAVAGE ORC
WITH BOW AND KNIFE
020900714



SAVAGE ORC
WITH BOW 13
020900715



SAVAGE ORC
WITH BOW 14
020900716

ORCS & GOBLINS

SAVAGE ORC COMMAND



SAVAGE ORC
BIG BOSS 1
020901302



SAVAGE ORC
BIG BOSS 2
020901309



SAVAGE ORC
BOSS 1
020901301



SAVAGE ORC
BOSS 2
020901308



SAVAGE ORC
SHAMAN 1
020900403



SAVAGE ORC
SHAMAN 2
020900410



SAVAGE ORC
BANNER BEARER 1
020901205



SAVAGE ORC
DRUMMER
020901206



SAVAGE ORC
HORN BLOWER
020901204



SAVAGE ORC
BANNER BEARER 2
020901207



Designed by Alan Perry

Not suitable for children under 36 months due to small parts and essential pointed components. All models supplied unpainted.
© Copyright Games Workshop Ltd., 1997. All rights reserved.

ORCS & GOBLINS

SAVAGE ORC COMMAND



SAVAGE ORC
HORN BLOWER
020904404



SAVAGE ORC
BOSS
020904401



SAVAGE ORC
SHAMAN
020900501



SAVAGE ORC
STANDARD BEARER
020904402

THE COMPLETED SAVAGE ORC
BANNER BEARER CONSISTS OF:
1 x SAVAGE ORC BANNER BEARER
1 x SAVAGE ORC BANNER HEAD
1 x PLASTIC BOAR



SAVAGE ORC
BANNER HEAD
020904403

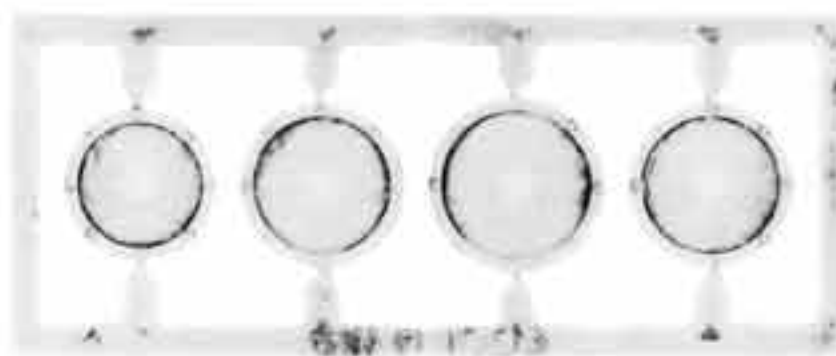

LARGE SHIELD SPRUE
111204

BOARBOYZ



SAVAGE ORC BOARBOY
WITH CLUB 1
020904302



SAVAGE ORC
BOARBOY WITH CLUB 2
020904301



SAVAGE ORC BOARBOY
WITH SPEAR 1
020900601



SAVAGE ORC BOARBOY
WITH SPEAR 2
020900602



ORCS & GOBLINS

THE COMPLETED SAVAGE ORC
BOARBOY CONSISTS OF:
1 x SAVAGE ORC BOARBOY
1 x PLASTIC BOAR
1 x PLASTIC LARGE SHIELD SPRUE
1 x PLASTIC BOAR HEAD



SAVAGE ORC BOAR BOYZ



SAVAGE ORC SHAMAN MOUNTED ON BOAR



BOAR BODY 1
129844



BOAR BODY 2
129844



BOAR HEAD 1
129844

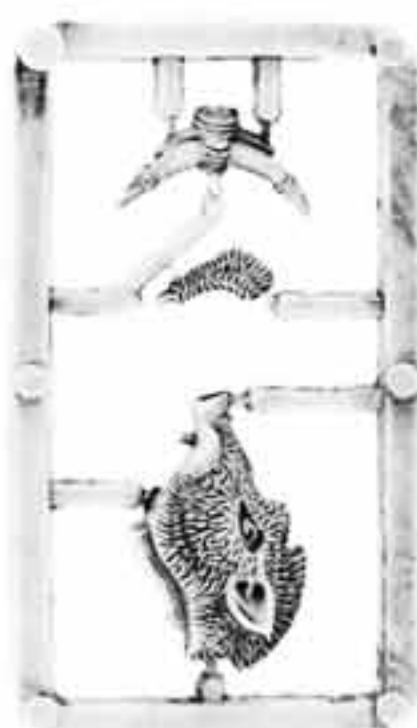

BOAR HEAD 2
129844



BOAR HEAD 3
129844



BOAR HEAD 4
129844



Designed by Alan Perry

Not suitable for children under 36 months due to small parts and essential pointed components. All models supplied unpainted.
© Copyright Games Workshop Ltd., 1997. All rights reserved.

ORCS

ORC BOAR BOYZ



ORC BOAR BOY 1
020904001



ORC BOAR BOY 2
020904002



ORC BOAR BOY 3
020904003



ORC BOAR BOY 4
020904004



ORC SHIELD SPRUE
111204



BOAR BOY SPEAR 1
020904005



BOAR BOY SPEAR 2
020904006



BOAR BOY SPEAR 3
020904007



ORC BOAR BOY

A COMPLETED ORC BOAR BOY CONSISTS OF:
1 x ORC BOAR BOY
1 x BOAR BOY SPEAR
1 x ORC SHIELD SPRUE
1 x PLASTIC BOAR SPRUE



ORC BOAR BOY



ORCS

ORC BOAR BOYZ COMMAND



BOSS
020902201



STANDARD BEARER
020902001



HORNBLOWER
020902101



SPEAR 1
020904005



SPEAR 2
020904006



SPEAR 3
020904007



HORNBLOWER'S ARM
020902102



STANDARD TOP
020902002

A COMPLETED ORC BOAR BOY HORN BLOWER CONSISTS OF:
1 x HORNBLOWER
1 x HORNBLOWER'S ARM
1 x PLASTIC BOAR SPRUE

A COMPLETED ORC BOAR BOY STANDARD BEARER CONSISTS OF:
1 x STANDARD BEARER
1 x STANDARD TOP
1 x PLASTIC BOAR SPRUE

A COMPLETED ORC BOAR BOY BOSS CONSISTS OF:
1 x BOSS
1 x SPEAR
1 x PLASTIC BOAR SPRUE



ORC BOAR BOYZ COMMAND GROUP



Designed by Brian Nelson

ORCS & GOBLINS

ORC WARLORD



ORC WARLORD
BODY
020904801



ORC WARLORD
SWORD ARM
020904803



ORC WARLORD
BANNER POLE
020904804



ORC WARLORD
BOAR'S TUSK
020904806



ORC WARLORD HEAD
020904802



ORC WARLORD BOAR'S HEAD
020904805

A COMPLETE ORC WARLORD
CONSISTS OF:
1 x ORC WARLORD BODY
1 x ORC WARLORD SWORD ARM
1 x ORC WARLORD BANNER POLE
1 x ORC WARLORD HEAD
1 x ORC WARLORD BOAR'S HEAD
2 x ORC WARLORD BOAR'S TUSKS
1 x PLASTIC BOAR SPRUE



ORC WARLORD

ORC SHAMAN



ORC SHAMAN BODY
020904903



ORC SHAMAN SWORD
020904901



ORC SHAMAN STAFF
020904902

A COMPLETE ORC SHAMAN
CONSISTS OF:
1 x ORC SHAMAN BODY
1 x ORC SHAMAN SWORD
1 x ORC SHAMAN BONE STAFF



ORC SHAMAN

NIGHT GOBLIN SHAMAN



NIGHT GOBLIN
SHAMAN BODY
020905001



NIGHT GOBLIN
SHAMAN STAFF
020905002



A COMPLETE NIGHT GOBLIN
SHAMAN CONSISTS OF:
1 x NIGHT GOBLIN SHAMAN BODY
1 x NIGHT GOBLIN SHAMAN STAFF



NIGHT GOBLIN SHAMAN



Designed by Brian Nelson

ORCS & GOBLINS

PLASTIC NIGHT GOBLIN REGIMENT

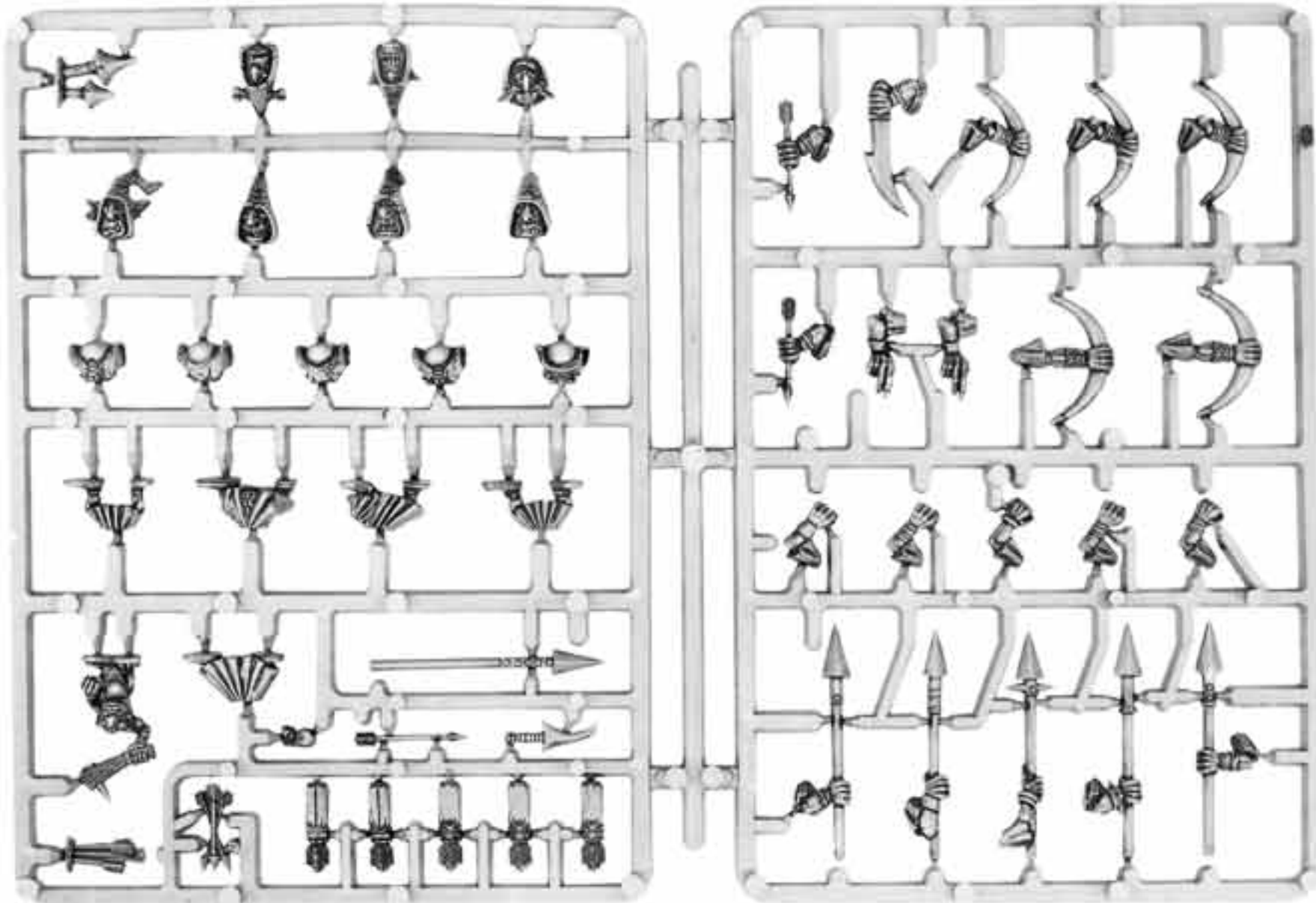

NIGHT GOBLIN PLASTIC SPRUE
99380209001
(SHOWN AT 60% ACTUAL SIZE)



LEADER'S HEAD
020911001



LEADER'S SWORD ARM
020911002



MUSICIAN'S ARM
020911005



MUSICIAN'S GONG ARM
020911004



STANDARD ARM
020911003



NIGHT GOBLIN SPEARMAN



NIGHT GOBLIN LEADER



NIGHT GOBLIN STANDARD BEARER



NIGHT GOBLIN ARCHER



Designed by Brian Nelson and Aly Morrison

Not recommended for children under 8 years due to small parts and essential pointed components. All models supplied unpainted.
© Copyright Games Workshop Ltd. 1998. All rights reserved.

ORCS & GOBLINS

GOBLIN DOOM DIVER



DOOM DIVER TORSO
020910908



DOOM DIVER LEGS
020910910



FLYING DOOM DIVER
020910906



RAMP SUPPORT
020910902



RAMP BASE
020910903



CATAPULT
020910904



RAMP
020910901



SNOTLING PULLERS
020910905



SNOTLING WITH Mallet
020910907



HOOK
020910909

A COMPLETE GOBLIN DOOM DIVER CONSISTS OF:

- 1 x DOOM DIVER TORSO
- 1 x DOOM DIVER LEGS
- 1 x FLYING DOOM DIVER
- 1 x RAMP SUPPORT
- 1 x RAMP BASE
- 1 x RAMP
- 1 x CATAPULT
- 1 x SNOTLING PULLERS
- 1 x SNOTLING WITH Mallet
- 1 x HOOK

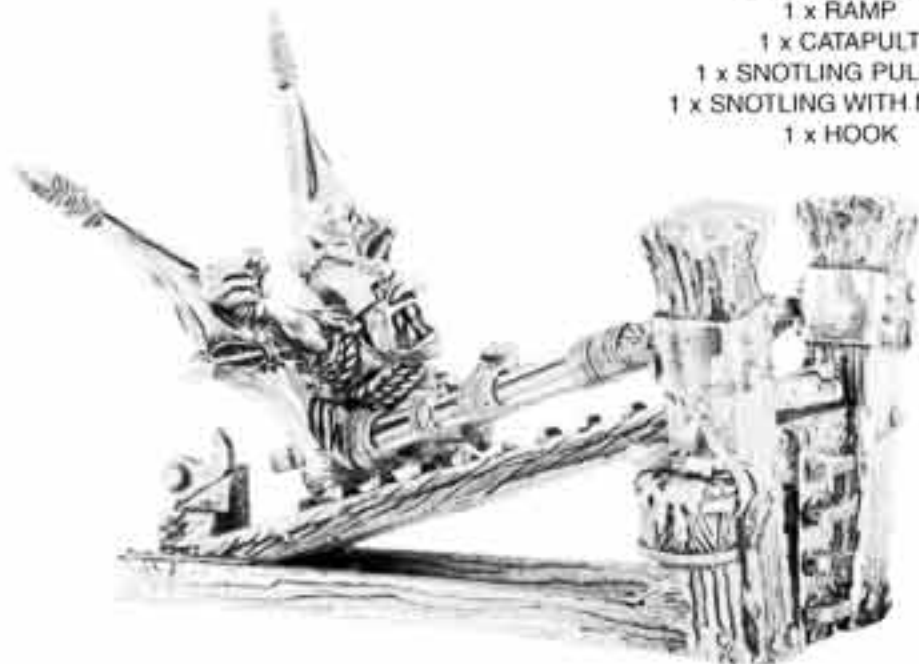

GOBLIN DOOM DIVER

ORCS & GOBLINS

NIGHT GOBLIN FANATICS



NIGHT GOBLIN FANATIC 1
0210905801



BALL AND CHAIN 1
0210905802



NIGHT GOBLIN FANATIC 2
0210905803



BALL AND CHAIN 2
0210905804



NIGHT GOBLIN FANATIC 3
0210905805



BALL AND CHAIN 3
0210905806



NIGHT GOBLIN FANATIC 4
0210905807



BALL AND CHAIN 4
0210905808

A COMPLETE NIGHT GOBLIN FANATIC CONSISTS OF:
1 x NIGHT GOBLIN FANATIC
1 x BALL AND CHAIN

PLEASE NOTE THAT THESE COMPONENTS ARE NOT INTERCHANGEABLE. FOR EXAMPLE NIGHT GOBLIN FANATIC 1 WILL NOT FIT BALL AND CHAIN 2 AND SO ON.



NIGHT GOBLIN FANATICS



Designed by Brian Nelson

ORCS & GOBLINS

GOBLINS



GOBLIN
STANDARD BEARER 1
020903016



GOBLIN
STANDARD BEARER 2
020903017



GOBLIN
STANDARD BEARER 3
020903018



GOBLIN
WITH SPEAR 10
020903001



GOBLIN
WITH SPEAR 11
020903002



GOBLIN
WITH SWORD 21
020903006



GOBLIN
WITH SWORD 22
020903007



GOBLIN
WITH SWORD 23
020903008



GOBLIN
WITH SWORD 24
020903009



GOBLIN
WITH SWORD 25
020903010



GOBLIN
WITH SWORD 26
020903011



GOBLIN
WITH SWORD 27
020903012



GOBLIN
WITH SWORD 28
020903013



GOBLIN
WITH CLUB 2
020903003



GOBLIN
WITH CLUB 1
020903015



GOBLIN
WITH MACE 1
020903005



GOBLIN
WITH AXE 4
020903004



GOBLIN
WITH AXE 5
020903014



GOBLIN
WITH SWORD
AND SHIELD



GOBLIN
WITH SWORD
AND SHIELD



ORCS & GOBLINS



WOLF RIDERS COMMAND



HORN BLOWER
020903803



BANNER BEARER
020903804



BOSS
020903801



BIG BOSS
020903802

WOLF RIDERS



WITH SPIKED CLUB
020903710



WITH SWORD 1
020903707



WITH AXE
020903709



WITH SWORD 2
020903708



ARCHER 1
020903706



ARCHER 2
020903711



ARCHER 3
020903712



ARCHER WITH SWORD
020903705



WITH SPEAR 1
020903713



WITH SPEAR 2
020903714



WITH SPEAR 3
020903715



WITH SPEAR 4
020900816

**A COMPLETE WOLF RIDER
CONSISTS OF:**
1 x GOBLIN WOLF RIDER
1 x PLASTIC WOLF SPRUE
1 x PLASTIC WOLF HEAD SPRUE
1 x PLASTIC SHIELD
1 x CAVALRY BASE



GOBLIN WOLF RIDER



PLASTIC WOLF SPRUE
100319



PLASTIC WOLF HEAD SPRUE
100319



ORCS & GOBLINS

FOREST GOBLIN COMMAND



FOREST GOBLINS



ORCS & GOBLINS

SPIDER RIDERS



FOREST GOBLIN
SPIDER BODY 1
020903602



FOREST GOBLIN
SPIDER BODY 2
020903603



FOREST GOBLIN
SPIDER LEGS
020903601



FOREST GOBLIN
SPIDER RIDER 2
020903607



FOREST GOBLIN
SPIDER RIDER 1
020903604



FOREST GOBLIN
SPIDER RIDER BANNER BEARER
020903606



FOREST GOBLIN
SPIDER RIDER BOSS
020903605



FOREST GOBLIN
SPIDER RIDER LEADER
020903608



FOREST GOBLIN
SPIDER RIDER 3
020903609

A COMPLETE SPIDER RIDER
CONSISTS OF:
1 x FOREST GOBLIN SPIDER RIDER
1 x FOREST GOBLIN SPIDER BODY
1 x FOREST GOBLIN SPIDER LEGS



FOREST GOBLIN SPIDER RIDER



ORCS & GOBLINS

CLUBBERS



CLUBBER 1
020903203



CLUBBER 2
020903204



CLUBBER 3
020903206



CLUBBER 4
020903205

NETTERS



NETTER 1
020903201



NETTER 2
020903202



NETTER 3
020903207



NETTER 4
020903208

NIGHT GOBLIN SHAMAN



NIGHT GOBLIN
SHAMAN
020902706



ORCS & GOBLINS

SKARSNIK AND GOBBLA



GOBBLA
020902902



SKARSNIK
020902901

SQUIG HOPPERS



NIGHT GOBLIN
SQUIG HOPPER 4
020903104



NIGHT GOBLIN
SQUIG HOPPER 3
020903103



NIGHT GOBLIN
SQUIG HOPPER 2
020903102



NIGHT GOBLIN
SQUIG HOPPER 1
020903101

SQUIGS & SQUIG HERDERS



CAVE SQUIG 1
020903302



CAVE SQUIG 2
020903303



CAVE SQUIG 3
020903304



NIGHT GOBLIN
SQUIG HUNTER 1
020903301



CAVE SQUIG 4
020903306



CAVE SQUIG 5
020903307



CAVE SQUIG 6
020903308



CAVE SQUIG 7
020903309



NIGHT GOBLIN
SQUIG HUNTER 2
020903305



Designed by the Citadel Design Team

Not suitable for children under 8 years due to small parts and essential pointed components. All models supplied unpainted.
© Copyright Games Workshop Ltd. 1998. All rights reserved.

ORCS & GOBLINS

SNOTLING PUMP WAGON

A COMPLETE
SNOTLING PUMP WAGON
CONSISTS OF:

- 1 x ROOF
- 1 x RIGHT SIDE
- 1 x LEFT SIDE
- 1 x PUMP HANDLE
- 1 x PUMP BASE
- 2 x DRIVE BELTS
- 1 x CHASSIS
- 1 x SPIKEY ROLLER
- 2 x WHEEL 1
- 2 x WHEEL 2
- 12 x SNOTLING CREW



SNOTLING PUMP WAGON



LEFT SIDE
020902301

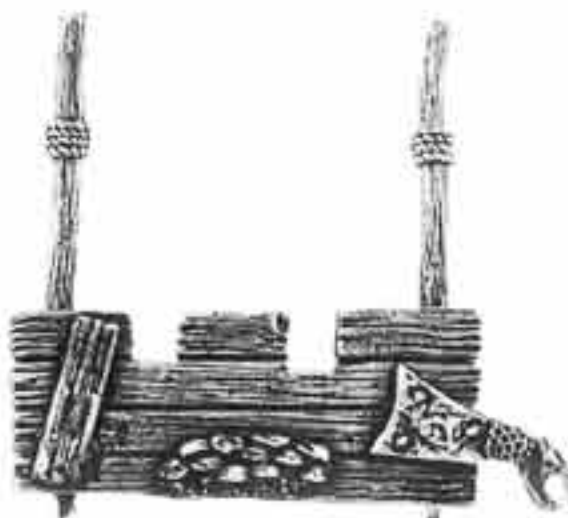

RIGHT SIDE
020902302



ROOF
020902303



PUMP BASE
020902306



WHEEL 1
020902304



WHEEL 2
020902310



PUMP HANDLE
020902308



DRIVE BELT
020902307



SPIKEY ROLLER
020902305

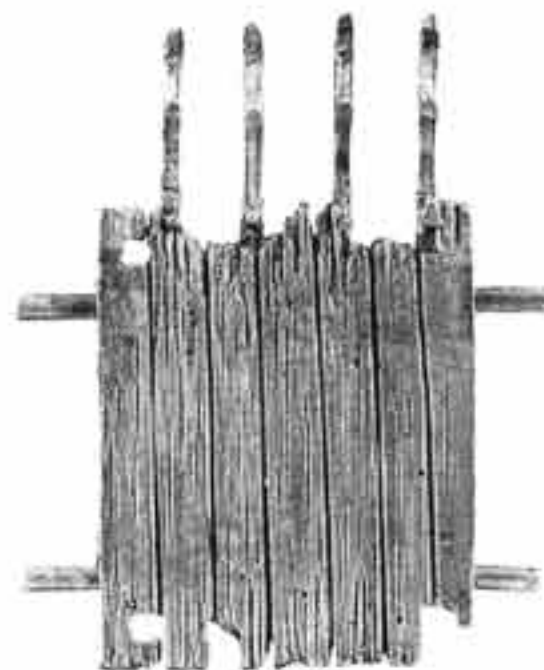

CHASSIS
020902309



CITADEL
MINIATURES



CITADEL
MINIATURES

ORCS & GOBLINS

SNOTLING PUMP WAGON CREW

NOTE:
APART FROM THE PUMP
HANDLE CREW, THE
SNOTLING CREW CAN BE
POSITIONED ANYWHERE
ON THE PUMP WAGON.



SNOTLING 1
020902327



SNOTLING 2
020902326



SNOTLING 3
020902326



SNOTLING 4
020902324



SNOTLING 5
020902323



SNOTLING 6
020902319

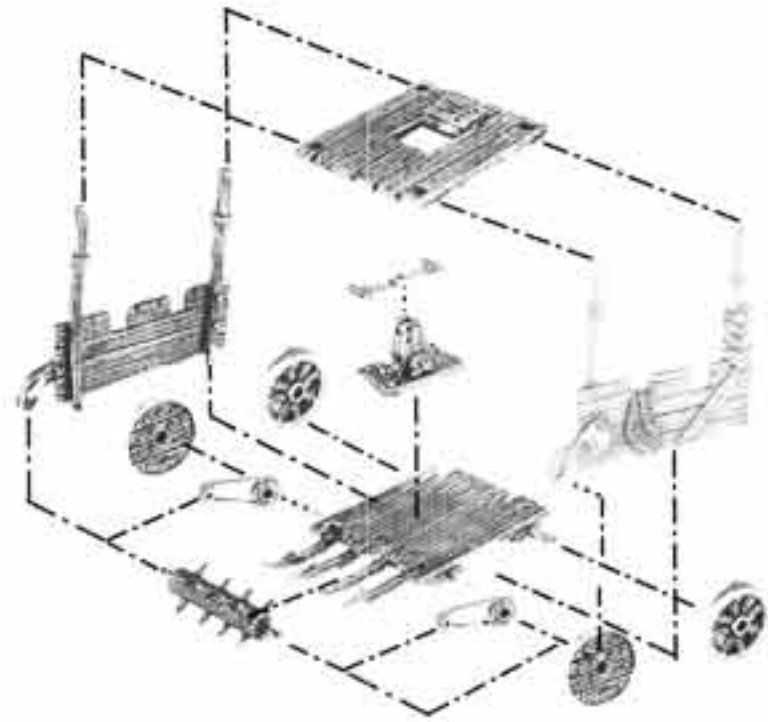

SNOTLING 7
020902327



SNOTLING 8
020902322



SNOTLING 9
020902314



SNOTLING 10
020902316



**SNOTLING PUMP
HANDLE CREW 1**
020902325



**SNOTLING PUMP
HANDLE CREW 2**
020902325



ORCS & GOBLINS

SNOTLINGS

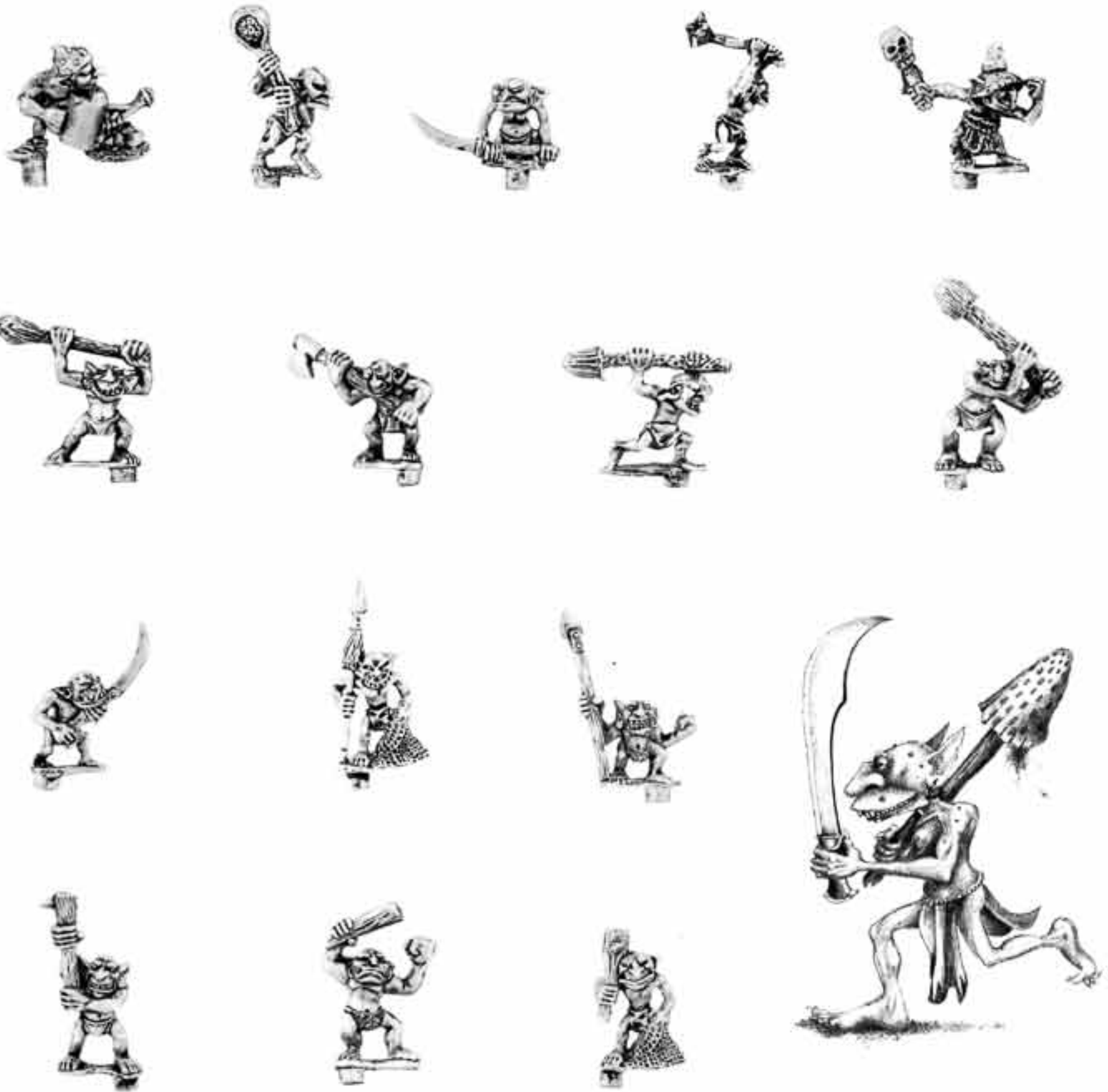

Snotlings are so small that they don't have individual codes; 0209 024 is the code for all the different Snotlings on this page. Simply indicate how many Snotlings you want and we'll send you a random assortment. We always try to ensure that there are as few duplicates as possible in each order.



SNOTLINGS



ORCS & GOBLINS

MORGLUM NECKSNAPPER



MORGLUM NECKSNAPPER'S
BODY
020901101



MORGLUM NECKSNAPPER'S
HEAD
020901102



MORGLUM NECKSNAPPER'S
RIGHT ARM
020901104



MORGLUM NECKSNAPPER'S
BANNER POLES
020901105

THE COMPLETE
MORGLUM NECKSNAPPER
CONSISTS OF:
1 x MORGLUM'S BODY
1 x MORGLUM'S HEAD
1 x MORGLUM'S LEFT ARM
1 x MORGLUM'S RIGHT ARM
1 x MORGLUM'S BANNER POLES
1 x MORGLUM'S WAR BOAR'S HEAD
1 x PLASTIC WAR BOAR



MORGLUM NECKSNAPPER'S
WAR BOAR'S HEAD
020901106



MORGLUM NECKSNAPPER'S
LEFT ARM
020901103



MORGLUM NECKSNAPPER



Designed by Alan Perry

Not suitable for children under 36 months due to small parts and essential pointed components. All models supplied unpainted.
© Copyright Games Workshop Ltd., 1997. All rights reserved.

ORCS & GOBLINS

AZHAG THE SLAUGHTERER



WYVERN HEAD
020904701



WYVERN RIGHT LEG
020904702



WYVERN BODY
020904704



WYVERN TAIL
020904703



AZHAG'S BODY
020904706



AZHAG'S LEFT ARM
020904708



AZHAG'S BANNER POLE
020904711



WYVERN NECK
020904705



AZHAG'S HEAD
020904707



WYVERN LEFT WING
102797



WYVERN HARNESS
020904710



WYVERN RIGHT WING
102796



WYVERN SADDLE
020904709



CITADEL
MINIATURES



CITADEL
MINIATURES

ORCS & GOBLINS

AZHAG THE SLAUGHTERER



AZHAG THE SLAUGHTERER

A COMPLETE AZHAG THE SLAUGHTERER

CONSISTS OF:

- 1 x AZHAG'S BODY
- 1 x AZHAG'S HEAD
- 1 x AZHAG'S LEFT ARM
- 1 x AZHAG'S BANNER POLE
- 1 x WYVERN SADDLE
- 1 x WYVERN HARNESS
- 1 x WYVERN HEAD
- 1 x WYVERN NECK
- 1 x WYVERN BODY
- 1 x WYVERN RIGHT LEG
- 1 x WYVERN TAIL
- 1 x WYVERN RIGHT WING
- 1 x WYVERN LEFT WING



Designed by Trish Morrison and Gary Morley

Not suitable for children under 36 months due to small parts and essential pointed components. All models supplied unpainted.
© Copyright Games Workshop Ltd., 1997. All rights reserved.

ORCS & GOBLINS

CHIEFTAIN GROM'S GOBLIN WAR CHARIOT



CHARIOT BASE
020904106



GROM THE PAUNCH
020904101



NIBLET
020904102



SKULL YOKE HEAD
020904105



CHARIOT YOKE
020904104



SOLID PLASTIC WHEEL
100558



CHARIOT HAFT
020904103



A COMPLETE CHIEFTAIN GROM'S GOBLIN WAR CHARIOT CONSISTS OF:

- 1 x GROM THE PAUNCH
- 1 x NIBLET
- 1 x CHARIOT BASE
- 1 x CHARIOT HAFT
- 2 x CHARIOT YOKE
- 1 x SKULL YOKE HEAD
- 2 x SOLID PLASTIC WHEELS
- 3 x PLASTIC WOLF
BODY SPRUES
- 3 x PLASTIC WOLF
HEAD SPRUES
- 3 x CAVALRY BASES

ORCS & GOBLINS

GOBLIN WOLF CHARIOT



LEFT SCYTHE
020900303

RIGHT SCYTHE
020900304



STANDARD TOP
020900307

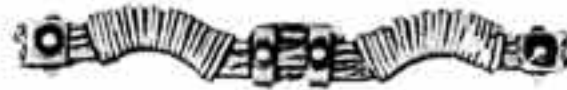

CHARIOT YOKE
020900301



STANDARD BEARER
020900311



PLASTIC WHEEL
100558

GOBLIN WOLF CHARIOT



TAIL & SKULLS 1
020900305



TAIL & SKULLS 2
020900306



SIDE 1
020900309



SIDE 2
020900310

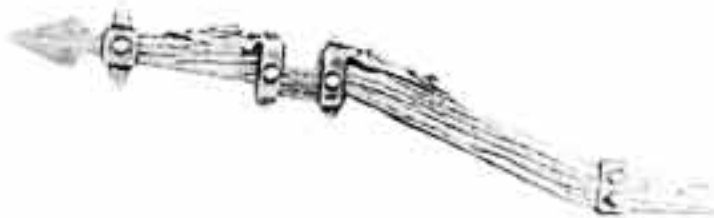

HAFT
020900302

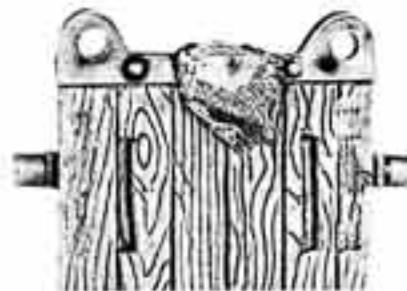

CHASSIS
020900308



ARCHER
020900313



DRIVER
020900312



THREE WOLF CHARIOT YOKE



THREE WOLF HAFT



THREE WOLF
CHARIOT HAFT
SUPPORT

- A COMPLETED
GOBLIN
WOLF CHARIOT
CONSISTS OF:
- 1 X YOKE
 - 1 X HAFT
 - 1 X LEFT SCYTHE
 - 1 X RIGHT SCYTHE
 - 1 X TAIL & SKULLS 1
 - 1 X TAIL & SKULLS 2
 - 1 X STANDARD TOP
 - 1 X CHASSIS
 - 2 X SIDES
 - 1 X STANDARD BEARER
 - 1 X DRIVER
 - 1 X ARCHER
 - 2 X PLASTIC WOLVES SPRUES
 - 2 X PLASTIC WHEELS
 - 1 X BANNER

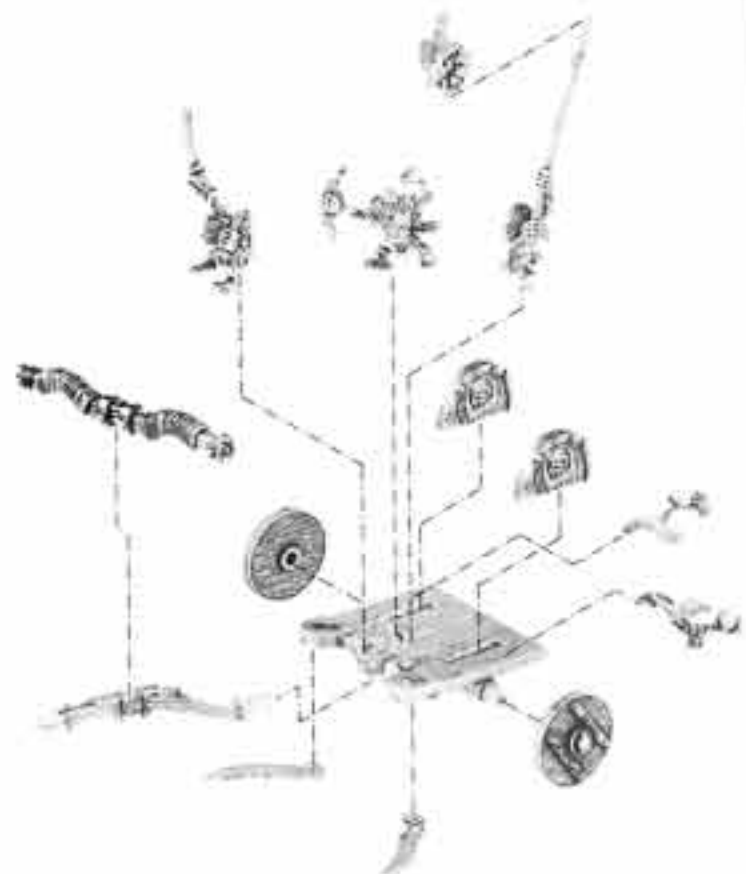

For those of you who want an even bigger and better chariot to terrify your enemies with, our Mail Order Trolls have got a special deal for a three wolf variant. Please note that these components are only available as part of a complete three wolf chariot, not as separate items.



CITADEL
MINIATURES



CITADEL
MINIATURES

Designed by Brian Nelson and Norman Swales

Not suitable for children under 8 years due to small parts and essential pointed components. All models supplied unpainted.
© Copyright Games Workshop Ltd. 1998. All rights reserved.

ORCS & GOBLINS

ORC ROCK LOBBER



ROCK LOBBER
COMMANDER
020904508



ROCK LOBBER
LOADER
020904510



ROCK LOBBER
SPOTTER
020904509

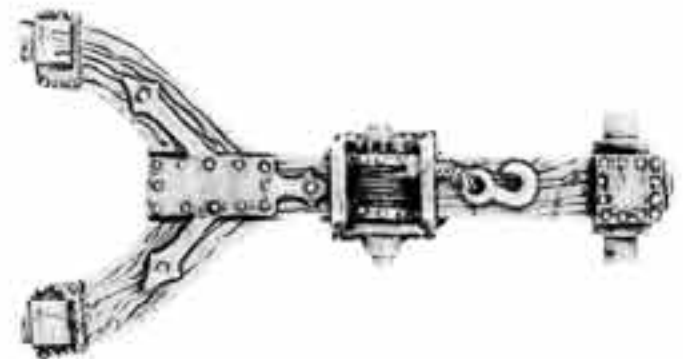

ROCK LOBBER
CHASSIS
020904502



ROCK LOBBER
UPRIGHT
020904501



ROCK LOBBER
THROWING ARM
020904503



SOLID PLASTIC
WHEEL
100558



COUNTER
BALANCE HALF A
020904504



COUNTER
BALANCE HALF B
020904505



ROCK LOBBER
HAND
020904507



WINCH HANDLES
020904506

- A COMPLETE ROCK LOBBER
CONSISTS OF:**
- 1 x ROCK LOBBER COMMANDER
 - 1 x ROCK LOBBER LOADER
 - 1 x ROCK LOBBER SPOTTER
 - 1 x ROCK LOBBER CHASSIS
 - 1 x ROCK LOBBER UPRIGHT
 - 1 x ROCK LOBBER
THROWING ARM
 - 1 x ROCK LOBBER HAND
 - 2 x WINCH HANDLES
 - 1 x COUNTER BALANCE HALF A
 - 1 x COUNTER BALANCE HALF B
 - 4 x SOLID PLASTIC WHEELS

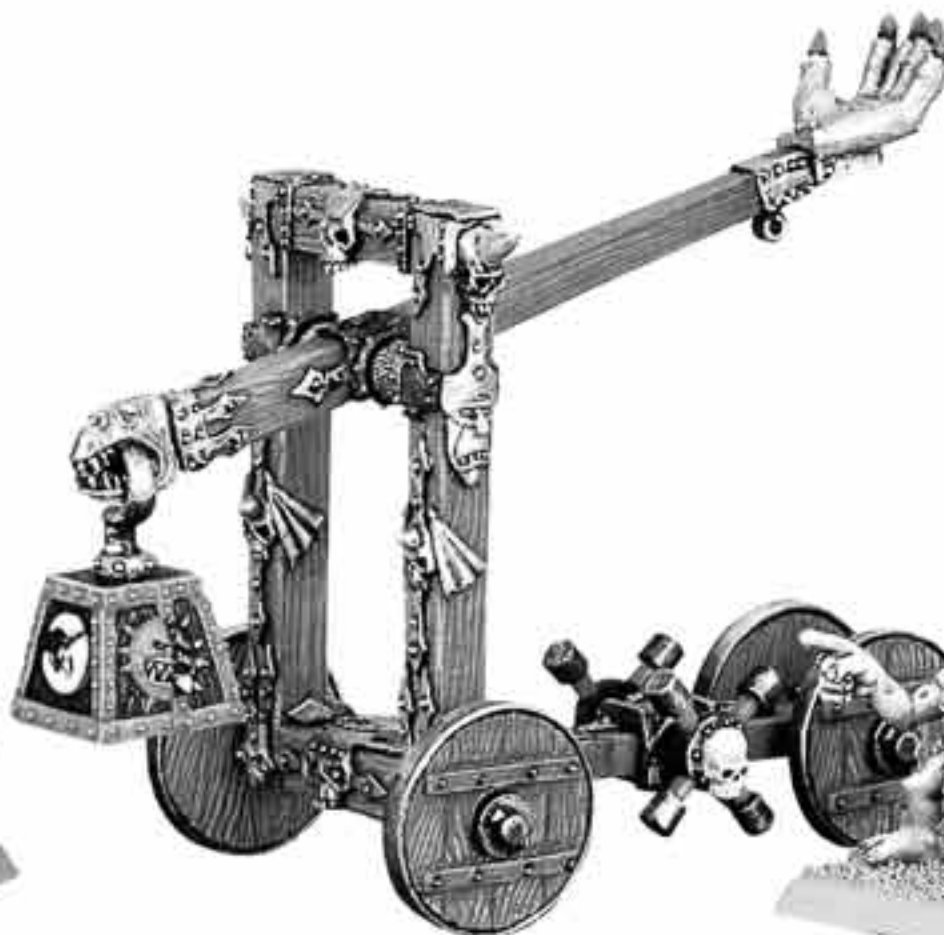

ORC ROCK LOBBER



OGRES

OGRES



OGRE WITH MACE
029900503



OGRE WITH TWO HANDED MACE
029900505



OGRE WITH AXE AND SPIKE
029900504



OGRE WITH SPIKED CLUB
029900506

OGRE STANDARD BEARER



OGRE STANDARD BEARER
029900501

A COMPLETE OGRE
STANDARD BEARER
CONSISTS OF:
1 x OGRE STANDARD BEARER
1 x STANDARD



STANDARD
029900502



OGRE STANDARD BEARER



Designed by Michael Perry

TROLLS

RIVER TROLLS



RIVER TROLL BODY 2
029900602



RIVER TROLL BODY 1
029900601



RIVER TROLL BODY 3
029900603



RIVER TROLL HEAD 1
029900604



RIVER TROLL HEAD 2
029900605



RIVER TROLL HEAD 3
029900606

A COMPLETE RIVER TROLL
CONSISTS OF:
1 x RIVER TROLL BODY
1 x RIVER TROLL HEAD
1 x MONSTER BASE



RIVER TROLLS



TROLLS

STONE TROLLS



STONE TROLL
WITH TWO-HANDED AXE
029900708



STONE TROLL
WITH STONE AXE AND BONE CLUB
029900709



STONE TROLL
WITH ROCK
029900707



STONE TROLL HEAD 1
029900704



STONE TROLL HEAD 2
029900705



STONE TROLL HEAD 3
029900706



A COMPLETE STONE TROLL
CONSISTS OF:
1 x STONE TROLL BODY
1 x STONE TROLL HEAD
1 x MONSTER BASE



STONE TROLLS



STONE TROLL WITH AXE
029900702



STONE TROLL WITH STONE HAMMER
029900701



STONE TROLL WITH BONE CLUB
029900703



Designed by Michael Perry

WARHAMMER SIEGE

WARHAMMER FORTRESS

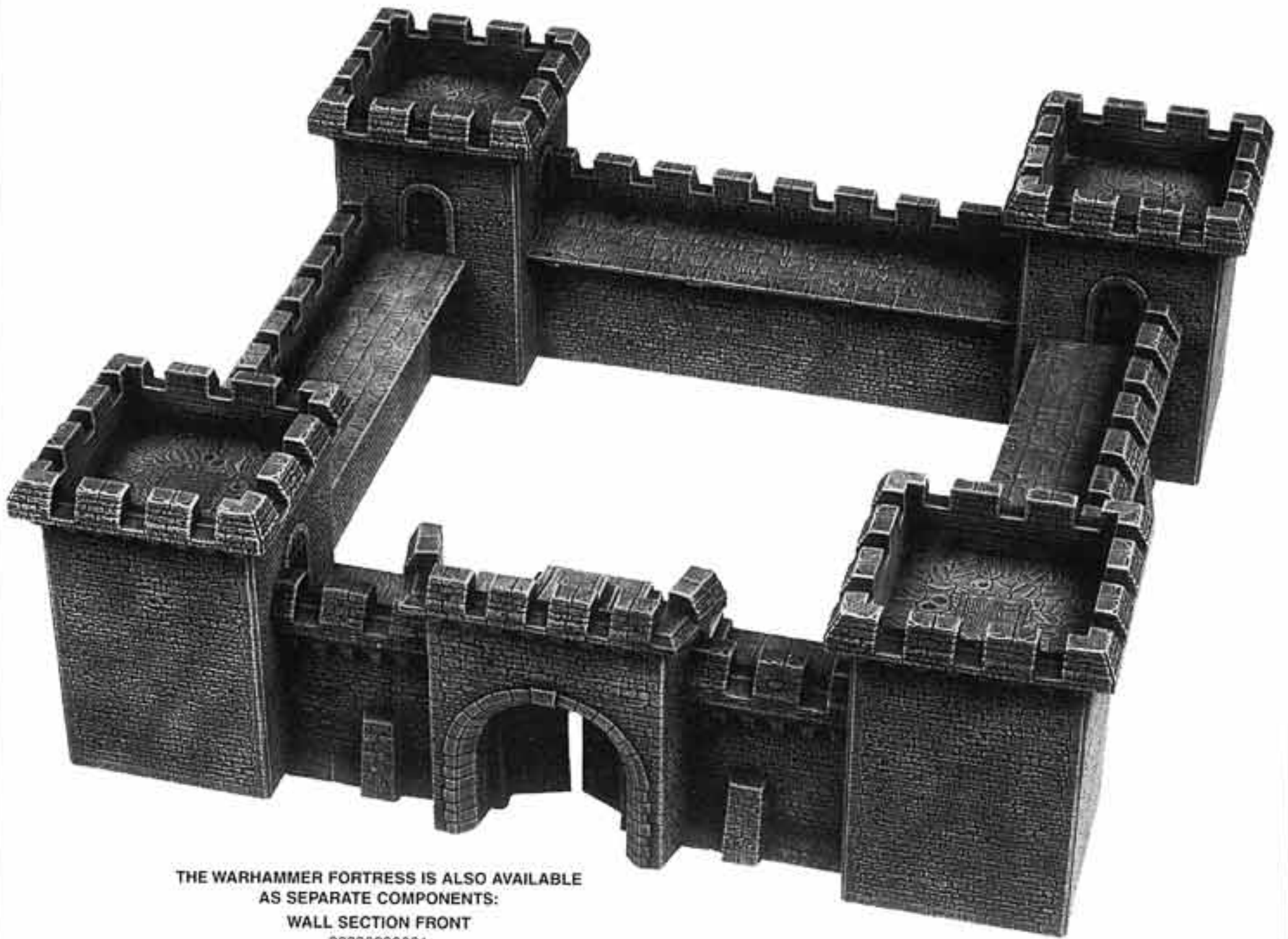

THE WARHAMMER FORTRESS IS ALSO AVAILABLE
AS SEPARATE COMPONENTS:

WALL SECTION FRONT

99390299001

WALL SECTION BACK

99390299002

TOWER WALL FRONT

99390299005

TOWER WALL BACK

99390299006

TOWER FLOOR SECTION

99390299007

GATE FRONT

99390299003

GATE BACK

99390299004

FORTRESS DOOR PLASTIC SPRUE

99390299008

**A COMPLETE WARHAMMER FORTRESS
CONSISTS OF:**

3 x WALL SECTION FRONT

3 x WALL SECTION BACK

8 x TOWER WALL FRONT

8 x TOWER WALL BACK

4 x TOWER FLOOR SECTION

1 x GATE FRONT

1 x GATE BACK

1 x FORTRESS DOOR PLASTIC SPRUE

PLEASE NOTE THAT THE WARHAMMER FORTRESS
MODEL IS SUPPLIED UNPAINTED



WARHAMMER SIEGE

FORTRESS DOOR PLASTIC SPRUE

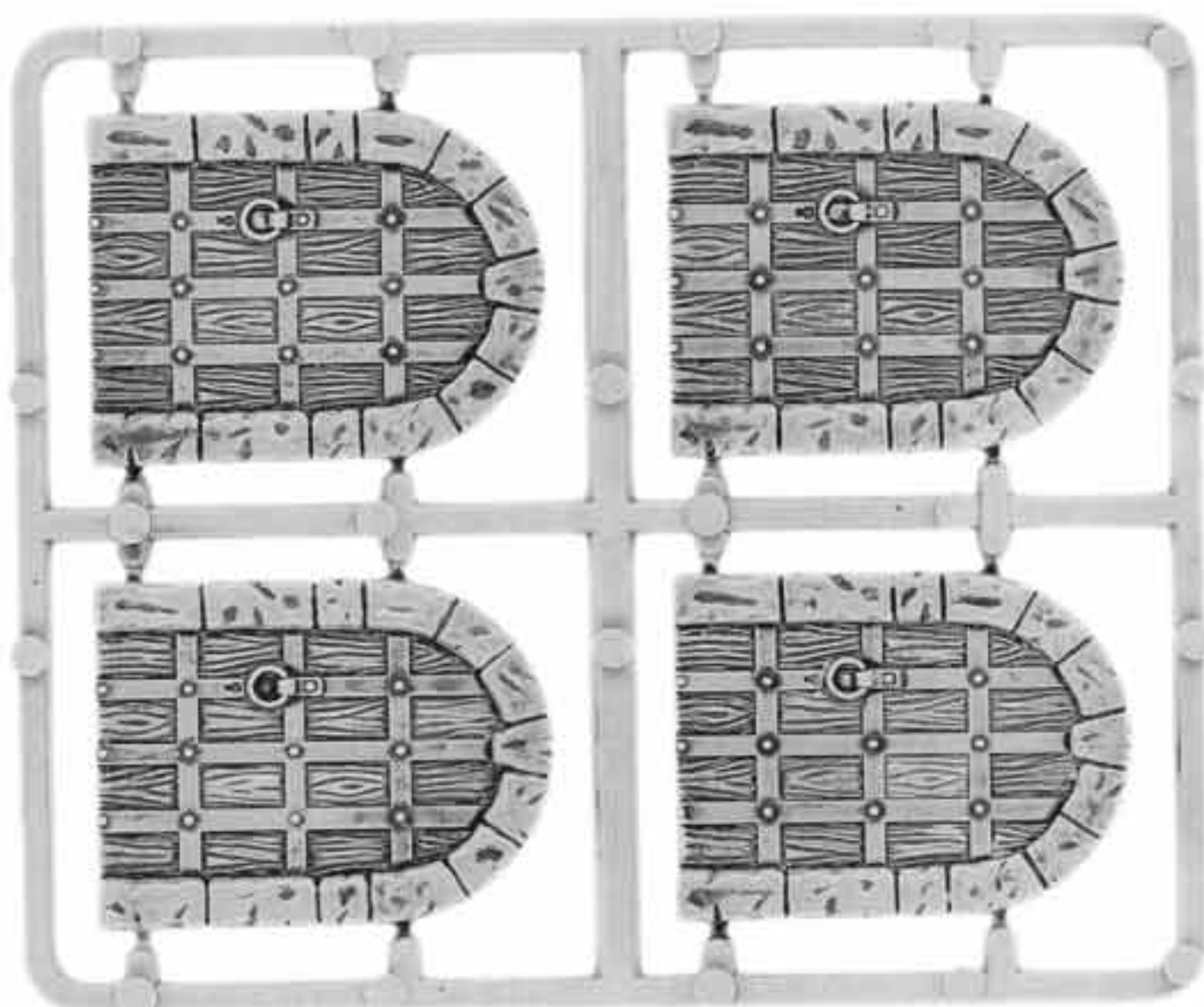

FORTRESS DOOR SPRUE

99390299008

(SHOWN ACTUAL SIZE)

PLEASE NOTE THAT THE FORTRESS DOORS ARE
SUPPLIED AS A SINGLE SPRUE



WARHAMMER SIEGE

WARHAMMER SIEGE TOWER

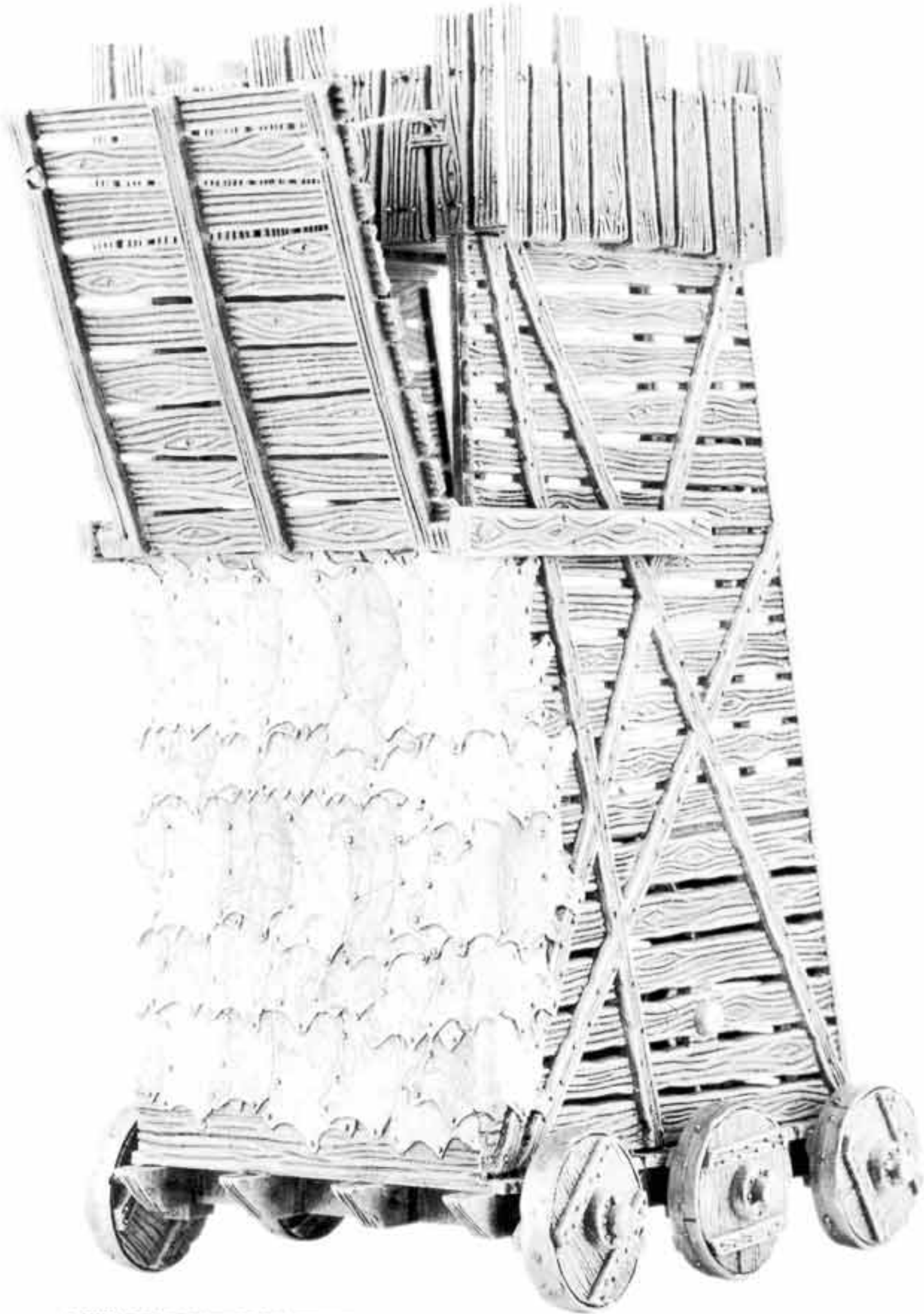

**A COMPLETE WARHAMMER SIEGE TOWER
CONSISTS OF:**

- 6 x SIEGE TOWER WHEELS - 99390299009
 - 1 x SIEGE TOWER SIDES SPRUE - 99390299010
 - 1 x SIEGE TOWER FLOORS SPRUE - 99390299011
 - 1 x SIEGE TOWER BASE SPRUE - 99390299012
 - 1 x SIEGE TOWER TOWER SPRUE - 99390299013
- (SIEGE TOWER SHOWN AT ACTUAL SIZE)

THE WARHAMMER SIEGE TOWER IS SUPPLIED UNPAINTED



WARHAMMER® SIEGE

SIEGE ATTACKERS – BATTERING RAM

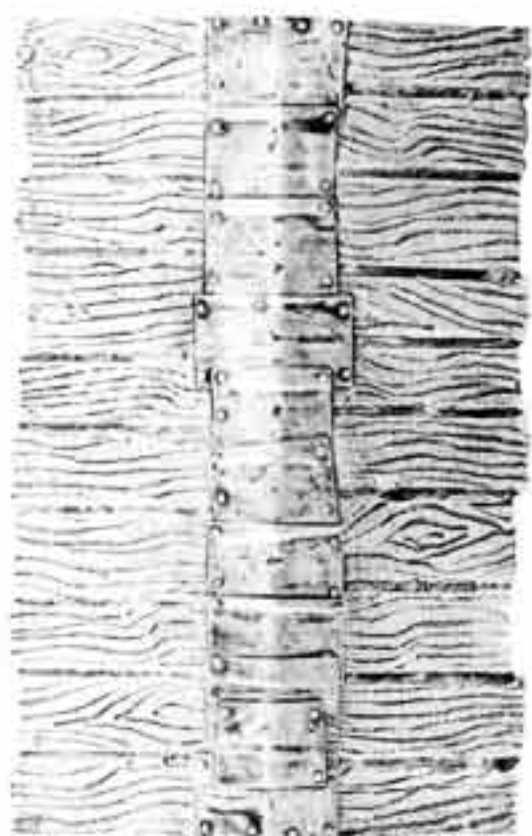

ROOF
029900901

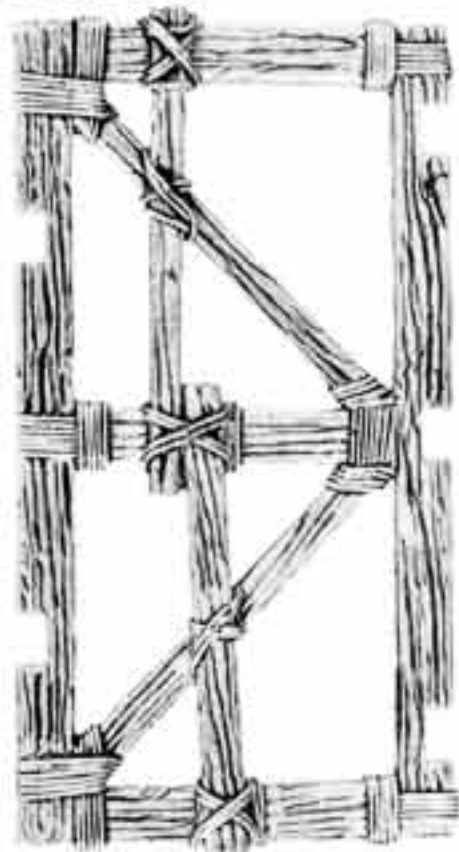

SIDE
029900902



RAM TIMBER 1
029900903



RAM TIMBER 2
029900904



RAM HEAD 1
029900909



RAM HEAD 2
029900910

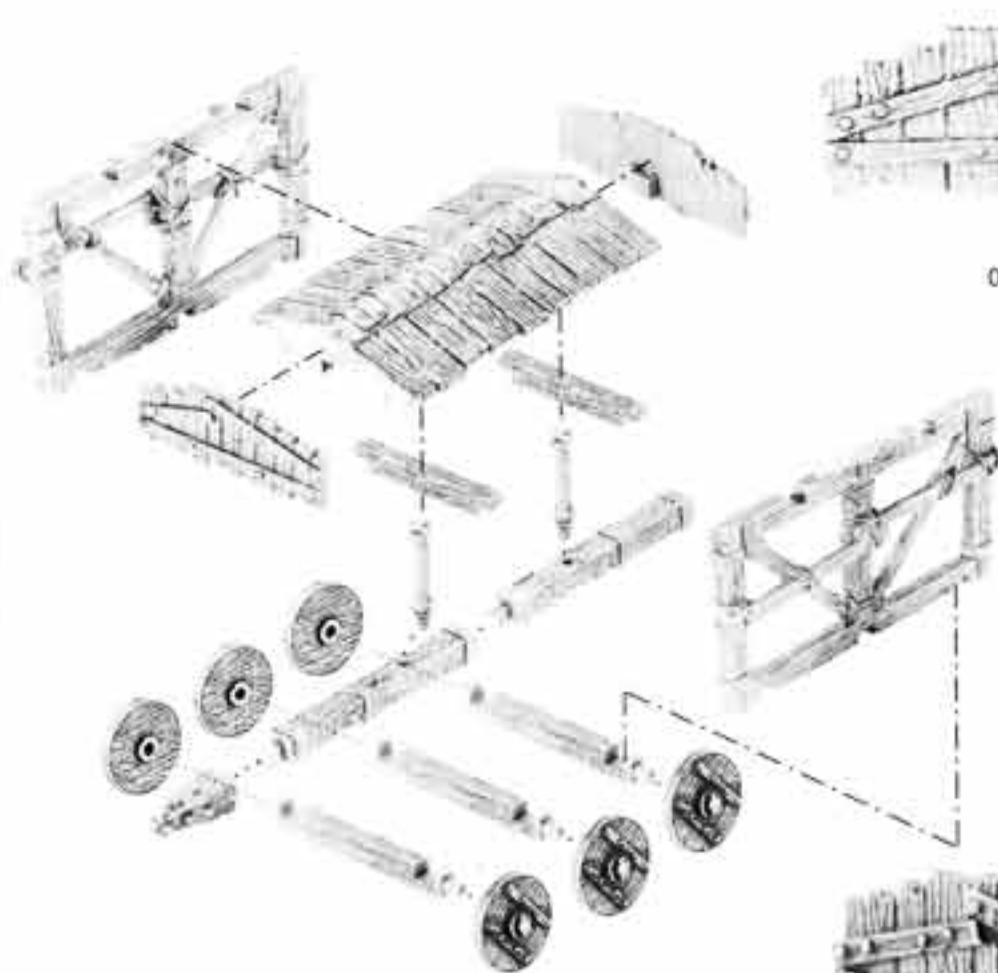

END
029900905



AXLE
029900906



BEAM
029900907



RAM CABLE
029900908

**A COMPLETE
SIEGE ATTACKERS BATTERING RAM
CONSISTS OF:**

- 1 x ROOF
- 2 x SIDE
- 1 x RAM TIMBER 1
- 1 x RAM TIMBER 2
- 2 x END
- 3 x AXLE
- 2 x BEAM
- 2 x RAM CABLE
- 1 x RAM HEAD

6 x SOLID WHEEL (SUPPLIED ON PLASTIC SPRUE)

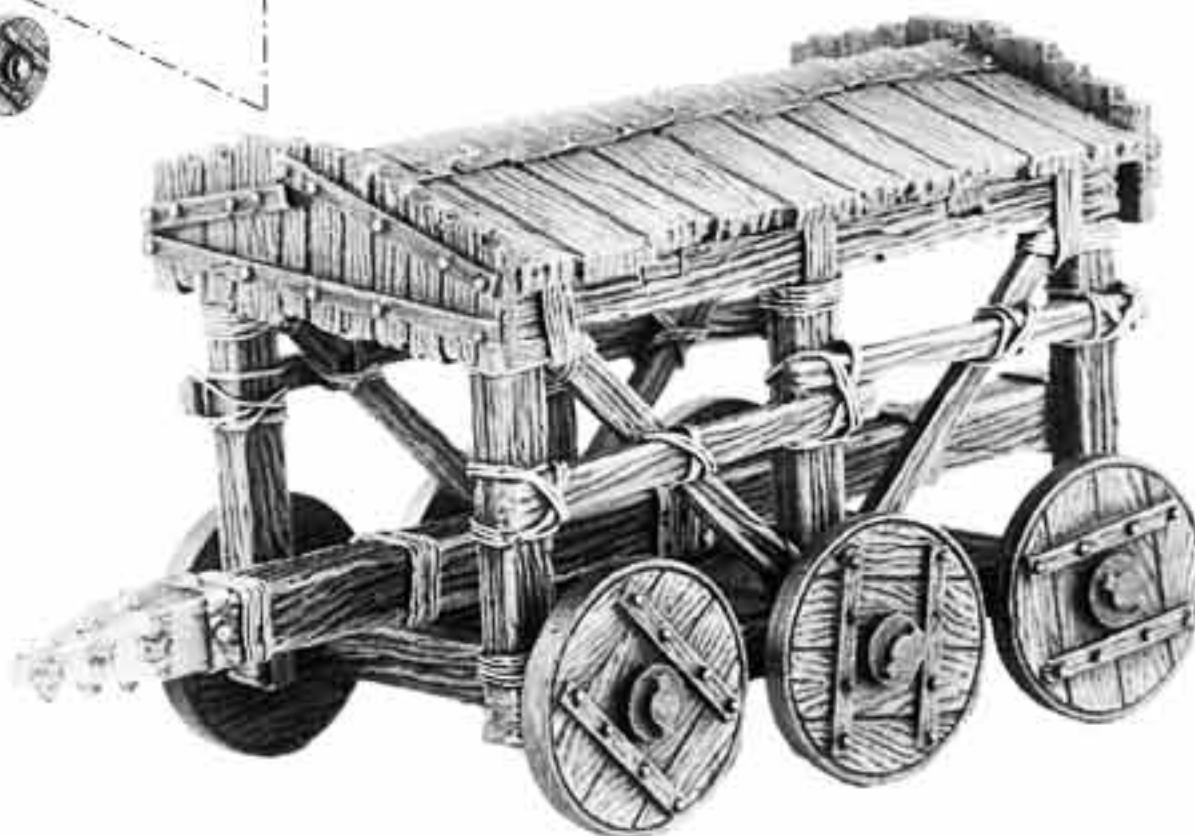

COMPLETE BATTERING RAM



Designed by Norman Swales

WARHAMMER® SIEGE

SIEGE MANTLETS

A COMPLETE
SIEGE MANTLET 1
CONSISTS OF:
1 x MANTLET 1
1 x MANTLET STRUT 1



MANTLET 1
029901101



MANTLET STRUT 1
029901102

A COMPLETE
SIEGE MANTLET 2
CONSISTS OF:
1 x MANTLET 2
2 x MANTLET SUPPORT

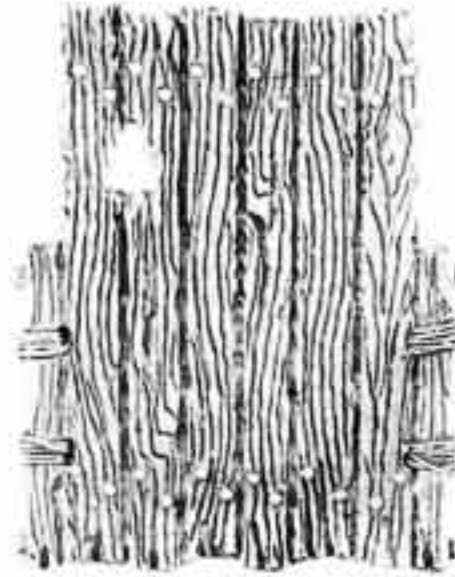

MANTLET 2
029901103



MANTLET SUPPORT
029901104

A COMPLETE
SIEGE MANTLET 4
CONSISTS OF:
1 x MANTLET 4
1 x MANTLET AXLE
2 x SOLID WHEEL (SUPPLIED ON PLASTIC SPRUE)



MANTLET 4
029901107



MANTLET AXLE
029901108

A COMPLETE
SIEGE MANTLET 3
CONSISTS OF:
1 x MANTLET 3
2 x MANTLET STRUT 2



MANTLET 3
029901105



MANTLET STRUT 2
029901106

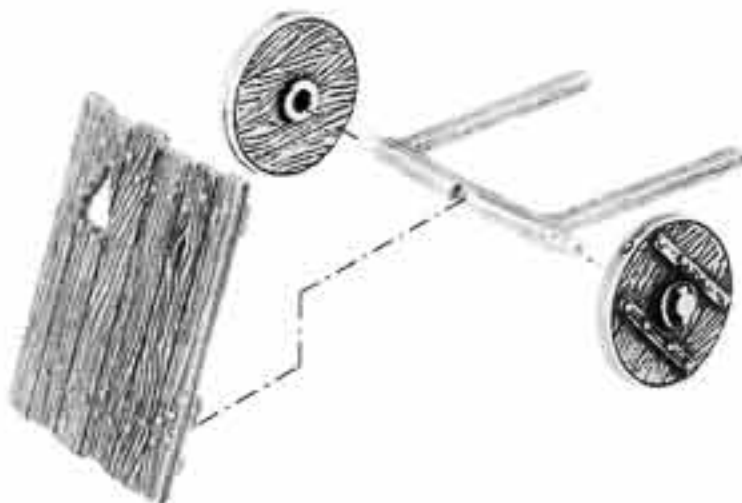

A COMPLETE MANTLET



WARHAMMER® SIEGE

SIEGE ATTACKERS – LADDERS

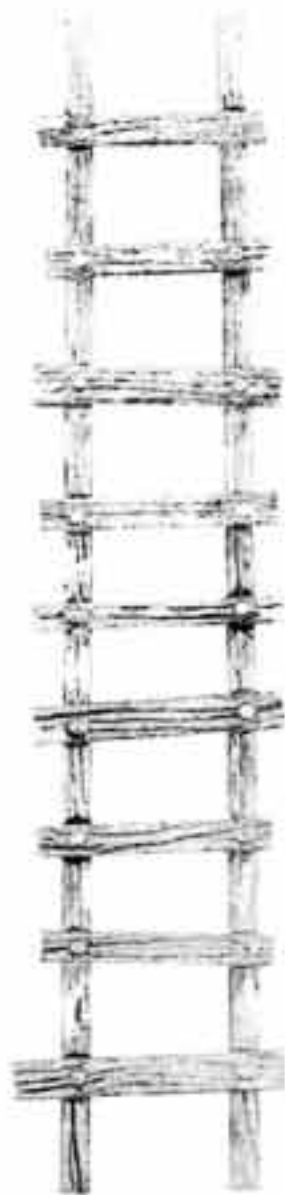

LADDER 1
029900911



LADDER 2
029900912

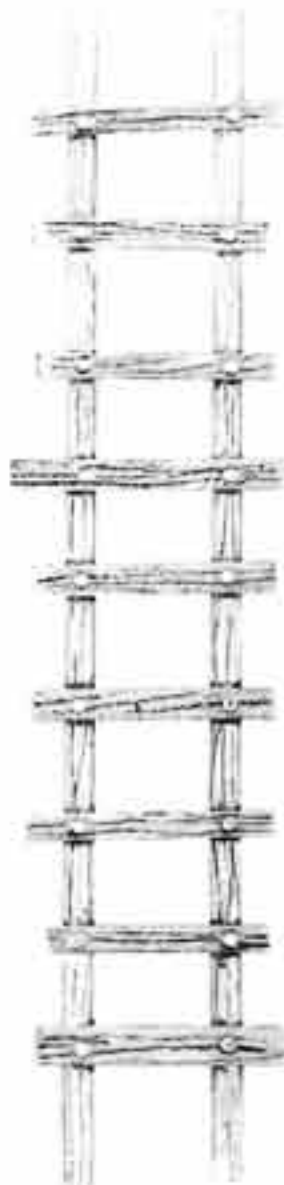

LADDER 3
029900913

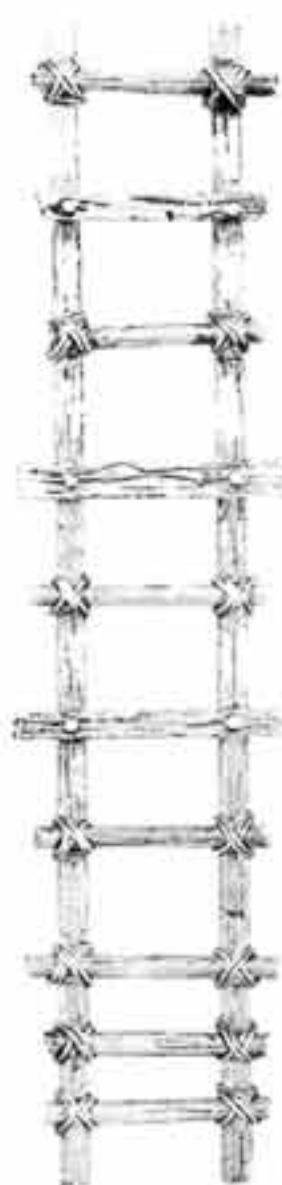

LADDER 4
029900914



LADDER 5
029900915



LADDER 6
029900916

SIEGE ATTACKERS – LOG RAMS

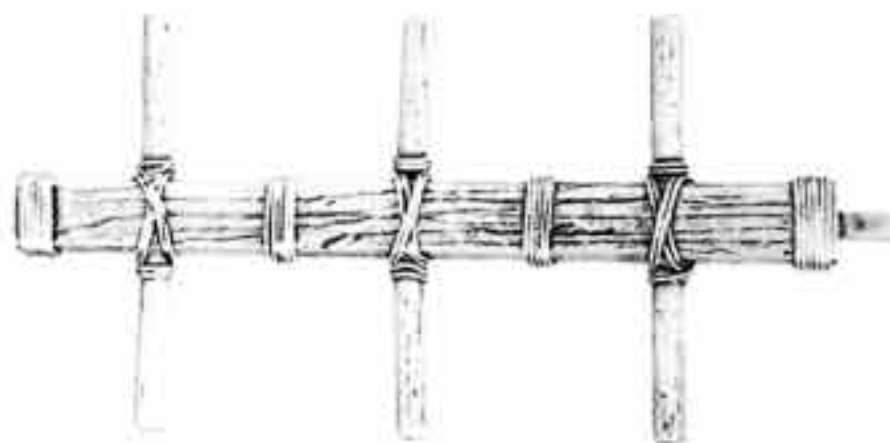

LOG RAM 1
029900917

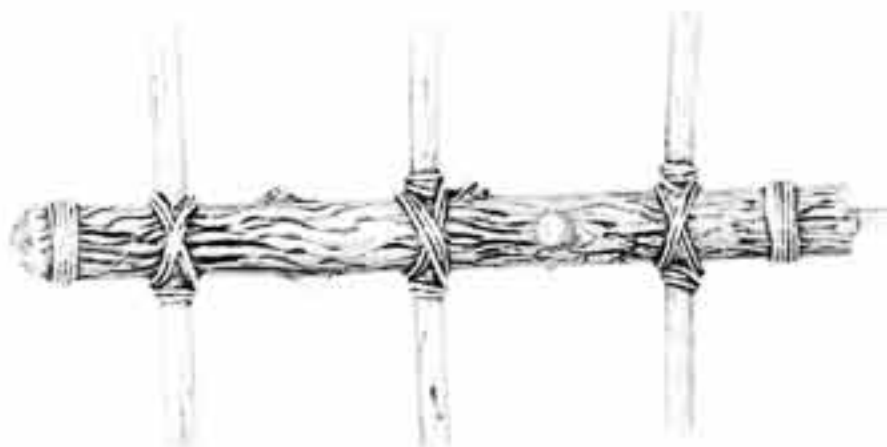

LOG RAM 2
029900918

A COMPLETE
SIEGE ATTACKERS LOG RAM
CONSISTS OF:
1 x LOG RAM
1 x RAM HEAD



RAM HEAD 1
029900909



RAM HEAD 2
029900910



Designed by Norman Swales

WARHAMMER® SIEGE

SIEGE DEFENDERS – ROCK DROPPERS



ROCK TRAY
029901001



PIVOT 1
029901002

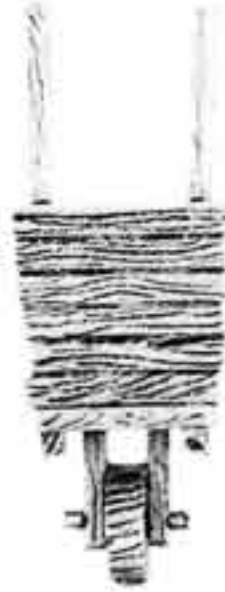

WHEEL BARROW
029901008

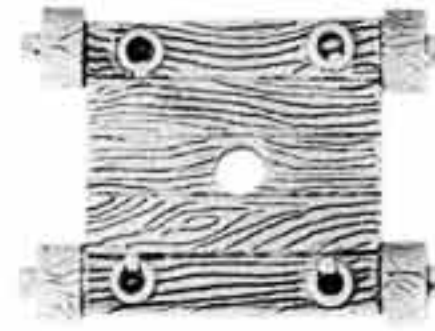

ROLLING BASE
029901006

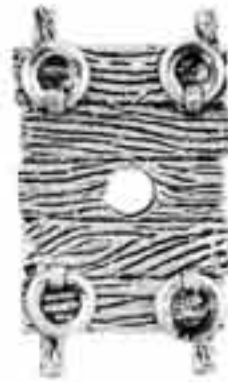

STATIC BASE
029901003



ROCK
029901009



ROCK SLING
029901007



PIVOT 2
029901005

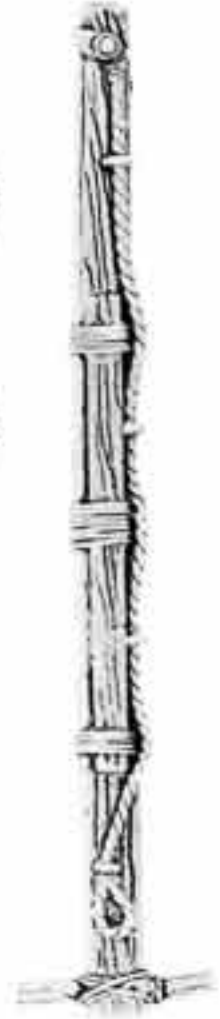

ARMATURE
029901004



A COMPLETE
SIEGE DEFENDERS
ROCK DROPPER 1
CONSISTS OF:
1 x ROCK TRAY
1 x STATIC BASE
1 x PIVOT 1

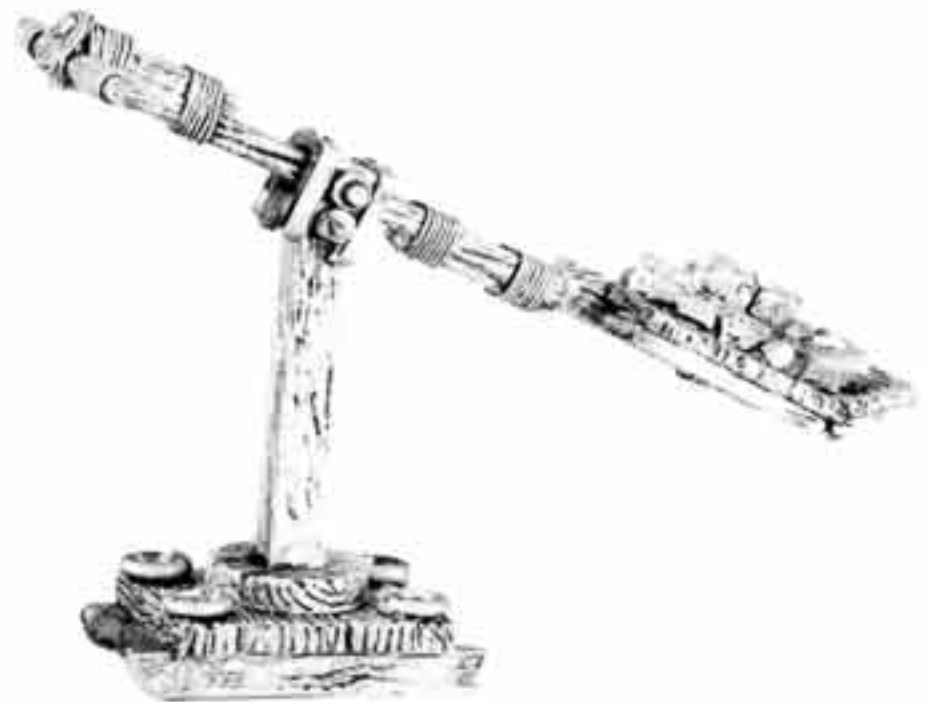

**COMPLETE
ROCK DROPPER 1**



A COMPLETE
SIEGE DEFENDERS
ROCK DROPPER 2
CONSISTS OF:
1 x ARMATURE
1 x ROLLING BASE
1 x PIVOT 2
1 x ROCK SLING

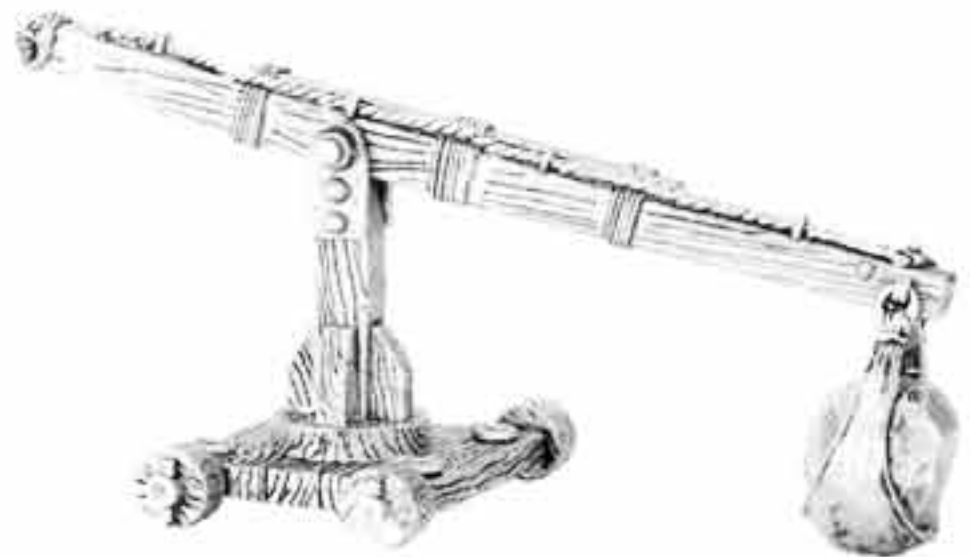

**COMPLETE
ROCK DROPPER 2**



WARHAMMER® SIEGE

SIEGE DEFENDERS – EQUIPMENT



BIG BARREL – BOTTOM
029901011



BIG BARREL – TOP
029901010



BIG BARREL – LID
029901012



SMALL BARREL – BOTTOM
029901014



SMALL BARREL – TOP
029901013



SMALL BARREL – LID
029901015



BIG ROCK BUCKET
029901016



SMALL ROCK BUCKET
029901017



SMALL PAIL
029901018



SMALL BUCKET
029901019



CAULDRON STAND
029901020

SIEGE DEFENDERS – CAULDRON OF BOILING OIL



BOILING OIL
029901021



CAULDRON
029901022



CRANK
029901023



FIRE CRATE
029901024



A COMPLETE
SIEGE DEFENDERS
CAULDRON OF BOILING OIL
CONSISTS OF:
2 x CAULDRON STAND
2 x CRANK
1 x BOILING OIL
1 x CAULDRON
1 x FIRE CRATE



A COMPLETE
CAULDRON OF BOILING OIL



Designed by Norman Swales

Not recommended for children under 8 years due to small parts and essential pointed components. All models supplied unpainted.
© Copyright Games Workshop Ltd. 1998. All rights reserved.

SKAVEN™

PLASTIC SKAVEN WARRIORS



PLASTIC SKAVEN SPRUE
105185



PLASTIC SKAVEN WARRIOR

THE SKAVEN SPRUE IS SUPPLIED WITH A VARIETY OF DIFFERENT SHIELD DESIGNS



SKAVEN™

STORMVERMIN



STORMVERMIN
WITH HALBERD 1
020600402



STORMVERMIN
WITH HALBERD 2
020600404



STORMVERMIN
WITH HALBERD 3
020600401

THESE MINIATURES ARE
SUPPLIED WITH PLASTIC
SHIELDS WHERE APPROPRIATE



STORMVERMIN
WITH HALBERD 4
020600471



STORMVERMIN
WITH HALBERD 5
020600473



STORMVERMIN
WITH HALBERD 6
020600472



STORMVERMIN
WITH HALBERD 7
020600474

PLAGUE MONKS



PLAGUE MONK 1
020600575



PLAGUE MONK 2
020600576



PLAGUE MONK 3
020600577



PLAGUE MONK 4
020600578

PLAGUE CENSER BEARERS



PLAGUE CENSER BEARER 1
020600886



PLAGUE CENSER BEARER 2
020600881



PLAGUE CENSER BEARER 3
020600887



PLAGUE CENSER BEARER 4
020600880



Designed by Colin Dixon

Not suitable for children under 36 months due to small parts and essential pointed components. All models supplied unpainted
© Copyright Games Workshop Ltd., 1997. All rights reserved.

SKAVEN™

CLAN PESTILENS PLAGUE MONK COMMAND



PLAGUE MONK CHAMPION
020602405



PLAGUE MONK MUSICIAN
020602307



PLAGUE MONK STANDARD BEARER
020602306

STORMVERMIN COMMAND



STORMVERMIN MUSICIAN
020602310



STORMVERMIN STANDARD BEARER
020602309



STORMVERMIN CHAMPION
020602508

CLAN SKRYRE POISONED WIND GLOBADIER



POISONED WIND GLOBADIER 1
020600702



POISONED WIND GLOBADIER 2
020600703



POISONED WIND GLOBADIER 3
020600705

A COMPLETE POISONED WIND GLOBADIER CONSISTS OF:
1 x GLOBADIER BACK PACK
1 x POISONED WIND GLOBADIER



GLOBADIER BACKPACK 1
020600704



GLOBADIER BACKPACK 2
020600706



CLAN SKRYRE POISONED WIND GLOBADIER



SKAVEN™

CLAN MOULDER PACK MASTERS



PACK MASTER 1
020601045



PACK MASTER 2
020601050



GIANT RAT 5
020601005



GIANT RAT 6
020601002



GIANT RAT 7
020601001



GIANT RAT 8
020601004



GIANT RAT 9
020601003

GUTTER RUNNERS



GUTTER RUNNER 1
020600688



GUTTER RUNNER 2
020600689



GUTTER RUNNER 3
020600690



GUTTER RUNNER 4
0206006891



GUTTER RUNNER 5
020600601



GUTTER RUNNER 6
020600602



GUTTER RUNNER 7
020600603



GUTTER RUNNER 8
020600604

Designed by Jes Goodwin, Colin Dixon and Trish Morrison

Not suitable for children under 36 months due to small parts and essential pointed components. All models supplied unpainted.
© Copyright Games Workshop Ltd., 1997. All rights reserved.

SKAVEN™

RAT OGRES



RAT OGRE HEAD 1
020600902



RAT OGRE HEAD 2
020600903



RAT OGRE HEAD 3
020600901



RAT OGRE TORSO 1
020600905



RAT OGRE TORSO 2
020600904



RAT OGRE TORSO 3
020600906



RAT OGRE LEGS 2
020600908



RAT OGRE LEGS 1
020600907

A COMPLETED SKAVEN RAT OGRE
CONSISTS OF:

- 1 x RAT OGRE HEAD
- 1 x RAT OGRE TORSO
- 1 x RAT OGRE LEGS



SKAVEN RAT OGRE



SKAVEN™

CLAN SKRYRE WARLOCKS

A COMPLETED SKAVEN WARLOCK WITH SKULL
AND SKAVEN WARLOCK WITH STAFF 1
CONSISTS OF:
1 x SKAVEN WARLOCK
1 x SKAVEN WARLOCK BANNER POLE



SKAVEN WARLOCK
WITH STAFF 1
020601501



SKAVEN WARLOCK
WITH SKULL
020601502



SKAVEN WARLOCK
BACK BANNER
020601503



SKAVEN WARLOCK



SKAVEN WARLOCK WITH
STAFF 2
020601504

NOTE: THE SKAVEN
WARLOCK WITH STAFF 2
IS NOT SUPPLIED WITH A
SKAVEN WARLOCK BACK
BANNER



CLAN ESHIN ASSASSINS



SKAVEN ASSASSIN 1
020601401



SKAVEN ASSASSIN 2
020601402



SKAVEN ASSASSIN 3
020601403



Designed by Colin Dixon

Not suitable for children under 36 months due to small parts and essential pointed components. All models supplied unpainted.
© Copyright Games Workshop Ltd., 1997. All rights reserved.

SKAVEN™

BONERIPPER



BONERIPPER'S HEAD
020602001



BONERIPPER'S LEFT ARM
020602003



BONERIPPER'S LEGS
020602004



BONERIPPER'S TORSO
020602002

THE COMPLETE BONERIPPER CONSISTS OF:

- 1 x BONERIPPER'S HEAD
- 1 x BONERIPPER'S TORSO
- 1 x BONERIPPER'S LEGS
- 1 x BONERIPPER'S LEFT ARM



BONERIPPER

GREY SEER THANQUOL



GREY SEER THANQUOL
020601701



CITADEL
MINIATURES



CITADEL
MINIATURES

SKAVEN™

VERMIN LORD GREATER DAEMON OF THE HORNED RAT



VERMIN LORD'S HEAD
020600101



VERMIN LORD'S TORSO
020600102



VERMIN LORD'S RIGHT ARM
WITH HALBERD
020600104



VERMIN LORD'S LEGS
020600103



VERMIN LORD'S LEFT ARM
020600105



VERMIN LORD'S TAIL
020600106



VERMIN LORD GREATER DAEMON OF THE HORNED RAT

THE COMPLETE VERMIN LORD CONSISTS OF:

- 1 x VERMIN LORD'S HEAD
- 1 x VERMIN LORD'S TORSO
- 1 x VERMIN LORD'S LEGS
- 1 x VERMIN LORD'S LEFT ARM
- 1 x VERMIN LORD'S RIGHT ARM
WITH HALBERD
- 1 x VERMIN LORD'S TAIL



Designed by Michael Perry

SKAVEN™

DEATH MASTER SNIKCH

THE COMPLETE DEATH MASTER SNIKCH
CONSISTS OF:
1 x DEATH MASTER SNIKCH'S BODY
1 x DEATH MASTER SWORD ARM



DEATHMASTER SNIKCH'S
BODY
020602102



DEATHMASTER SNIKCH'S
SWORD ARM
020602103



DEATHMASTER SNIKCH

LORD SKROLK



LORD SKROLK
020601601

WARLORD QUEEK

THE COMPLETE WARLORD QUEEK
CONSISTS OF:
1 x WARLORD QUEEK'S BODY
1 x WARLORD QUEEK'S TROPHY RACK



WARLORD QUEEK'S BODY
020601801



WARLORD QUEEK'S TROPHY RACK
020601802



WARLORD QUEEK

IKIT CLAW CHIEF WARLOCK

THE COMPLETE IKIT CLAW
CONSISTS OF:
1 x IKIT CLAW'S BODY
1 x IKIT CLAW'S BANNER



IKIT CLAW'S BANNER
020601902



IKIT CLAW'S BODY
020601901



IKIT CLAW CHIEF WARLOCK



SKAVEN™

SKAVEN WARPFIRE THROWER



WARPFIRE THROWER
FUEL CARRIER 1
020601302



WARPFIRE THROWER
FUEL CARRIER 2
020601304

A COMPLETE WARPFIRE THROWER TEAM
CONSISTS OF:
1 x WARPFIRE GUNNER
1 x WARPFIRE FUEL CARRIER



WARPFIRE THROWER
GUNNER 1
020601301



WARPFIRE THROWER
GUNNER 2
020601304



SKAVEN WARPFIRE THROWER TEAM

SKAVEN JEZZAILS



JEZZAIL GUNNER 1
020601201



JEZZAIL GUNNER 2
020601203

A COMPLETE JEZZAIL TEAM
CONSISTS OF:
1 x JEZZAIL GUNNER
1 x JEZZAIL REST



JEZZAIL REST 1
020601202



JEZZAIL REST 2
020601204



SKAVEN JEZZAIL TEAM



CITADEL
MINIATURES

Designed by Colin Dixon

479

Not suitable for children under 36 months due to small parts and essential pointed components. All models supplied unpainted.
© Copyright Games Workshop Ltd., 1997. All rights reserved.

SKAVEN™

SKAVEN SCREAMING BELL



SCREAMING BELL
BELL SUPPORT
020600304

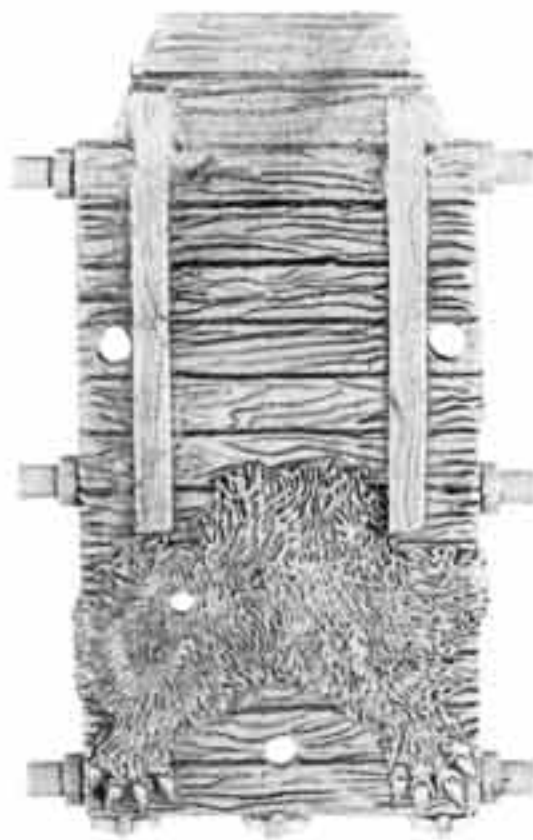

SCREAMING BELL
PLATFORM
020600303

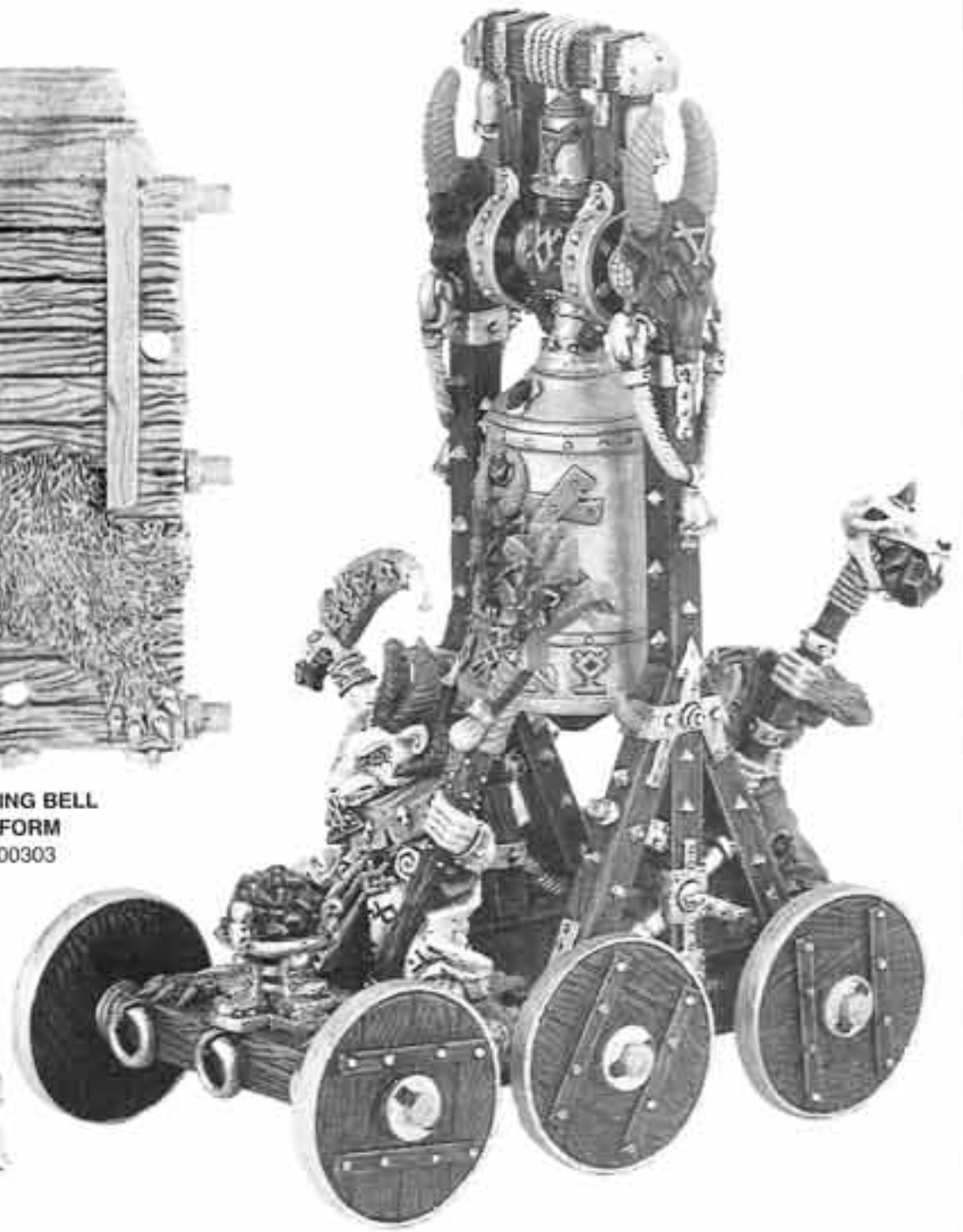

SCREAMING BELL
GREY SEER
020600301



SCREAMING BELL
COUNTER WEIGHT
020600306



SCREAMING BELL
BELL HALF
020600305



PLASTIC WHEEL
100558



SCREAMING BELL
BELL STRIKER
020600302



SCREAMING BELL
BELL CLANGER
020600308

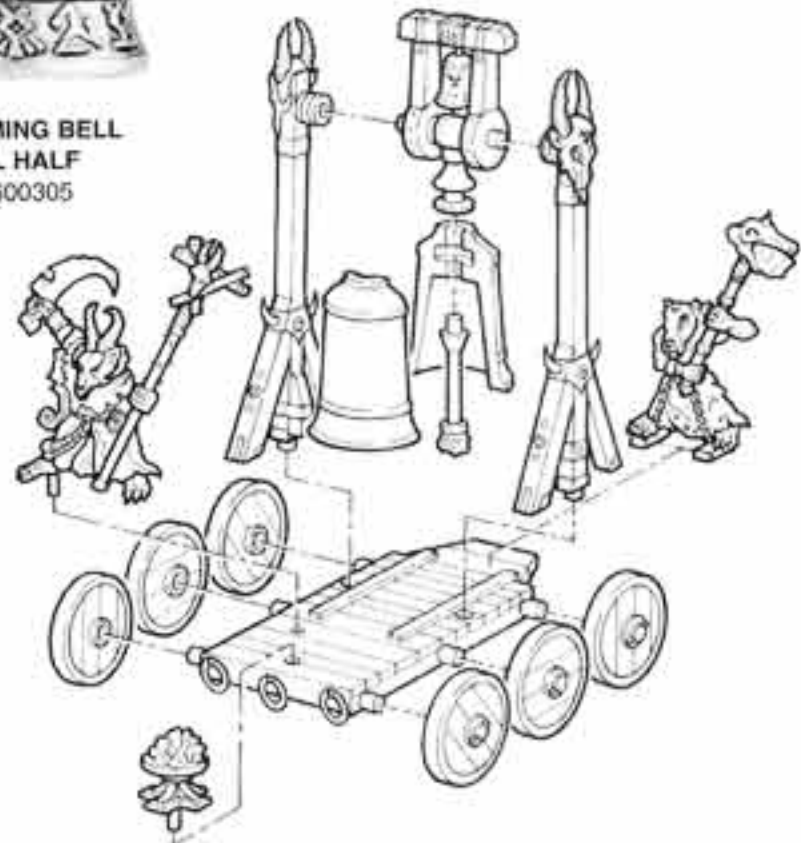

SCREAMING BELL
WARPSTONE BRAZIER
020600307

- THE COMPLETE SCREAMING BELL
CONSISTS OF:**
- 1 x SCREAMING BELL GREY SEER
 - 1 x SCREAMING BELL BELL STRIKER
 - 1 x SCREAMING BELL PLATFORM
 - 2 x SCREAMING BELL BELL SUPPORTS
 - 2 x SCREAMING BELL BELL HALVES
 - 1 x SCREAMING BELL COUNTERWEIGHT
 - 1 x SCREAMING BELL WARPSTONE BRAZIER
 - 1 x SCREAMING BELL BELL CLANGER
 - 6 x PLASTIC WHEELS

SKAVEN™

DOOMWHEEL



DOOMWHEEL FORWARD
LIGHTNING PROJECTOR
020600209



DOOMWHEEL WARLOCK
ENGINEER TOP
020600201



DOOMWHEEL
WHEEL RATS
020600205



DOOMWHEEL CHAIR BACK
020600203



DOOMWHEEL WARLOCK
ENGINEERS BOTTOM
020600202



DOOMWHEEL WARPSTONE
GENERATOR CHAMBER
020600208



DOOMWHEEL
LIGHTNING PROJECTOR
020600210



DOOMWHEEL STERN AXLE
020600207



DOOMWHEEL
GENERATOR HUB
020600206



SOLID PLASTIC WHEEL
100558



DOOMWHEEL WHEEL
020600204

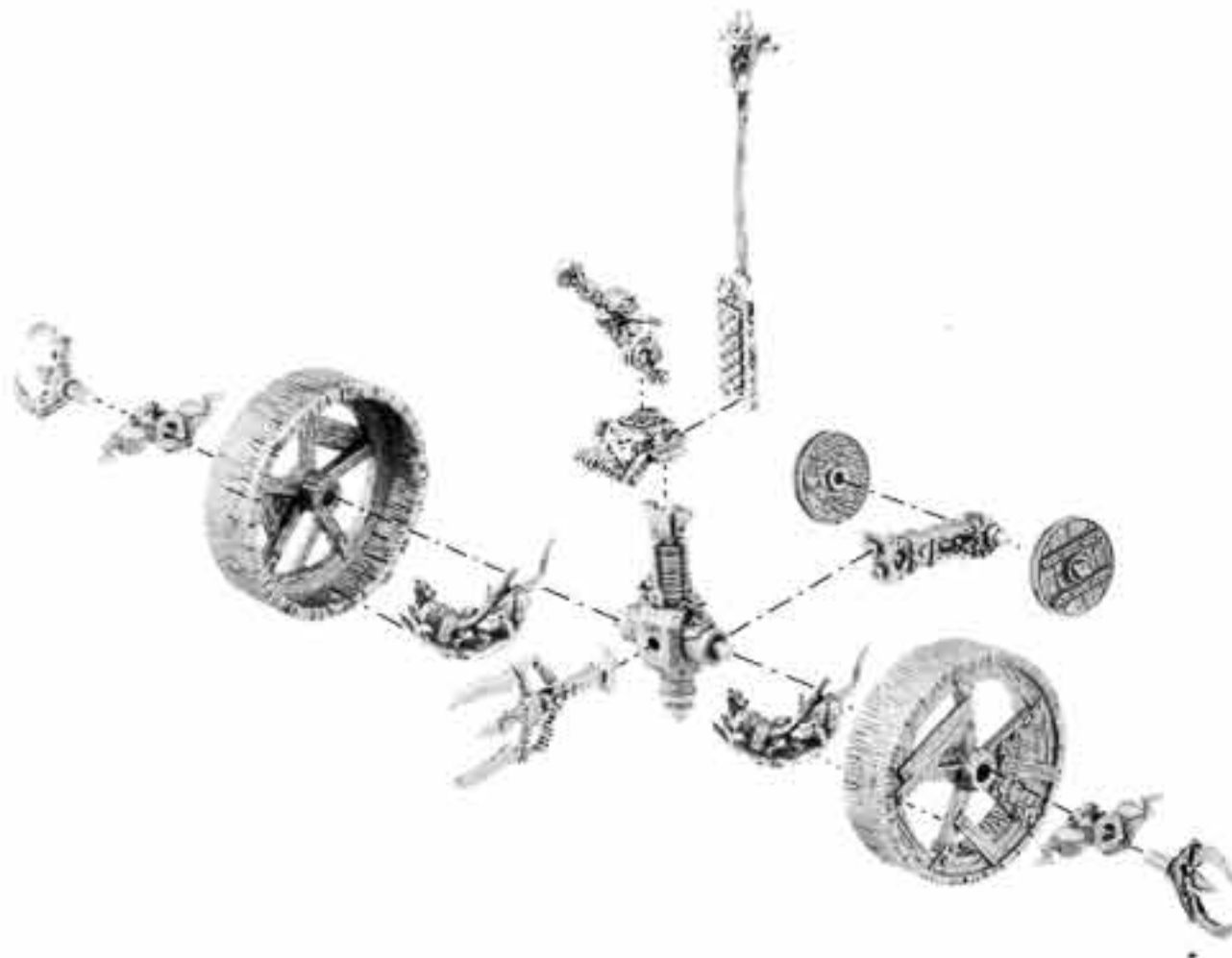

Designed by Jes Goodwin and Norman Swales

SKAVEN™

DOOMWHEEL

- THE COMPLETE SKAVEN DOOMWHEEL
CONSISTS OF:**
- 1 x DOOMWHEEL WARLOCK ENGINEERS TOP
 - 1 x DOOMWHEEL WARLOCK ENGINEERS BOTTOM
 - 1 x DOOMWHEEL CHAIR BACK
 - 1 x DOOMWHEEL GENERATOR HUB
 - 1 x DOOMWHEEL STERN AXLE
 - 1 x DOOMWHEEL FORWARD LIGHTNING PROJECTOR
 - 2 x DOOMWHEEL SIDE LIGHTNING PROJECTORS
 - 2 x DOOMWHEEL WARPSTONE GENERATOR CHAMBERS
 - 2 x DOOMWHEEL WHEELS
 - 2 x DOOMWHEEL WHEEL RATS
 - 2 x SOLID PLASTIC WHEELS

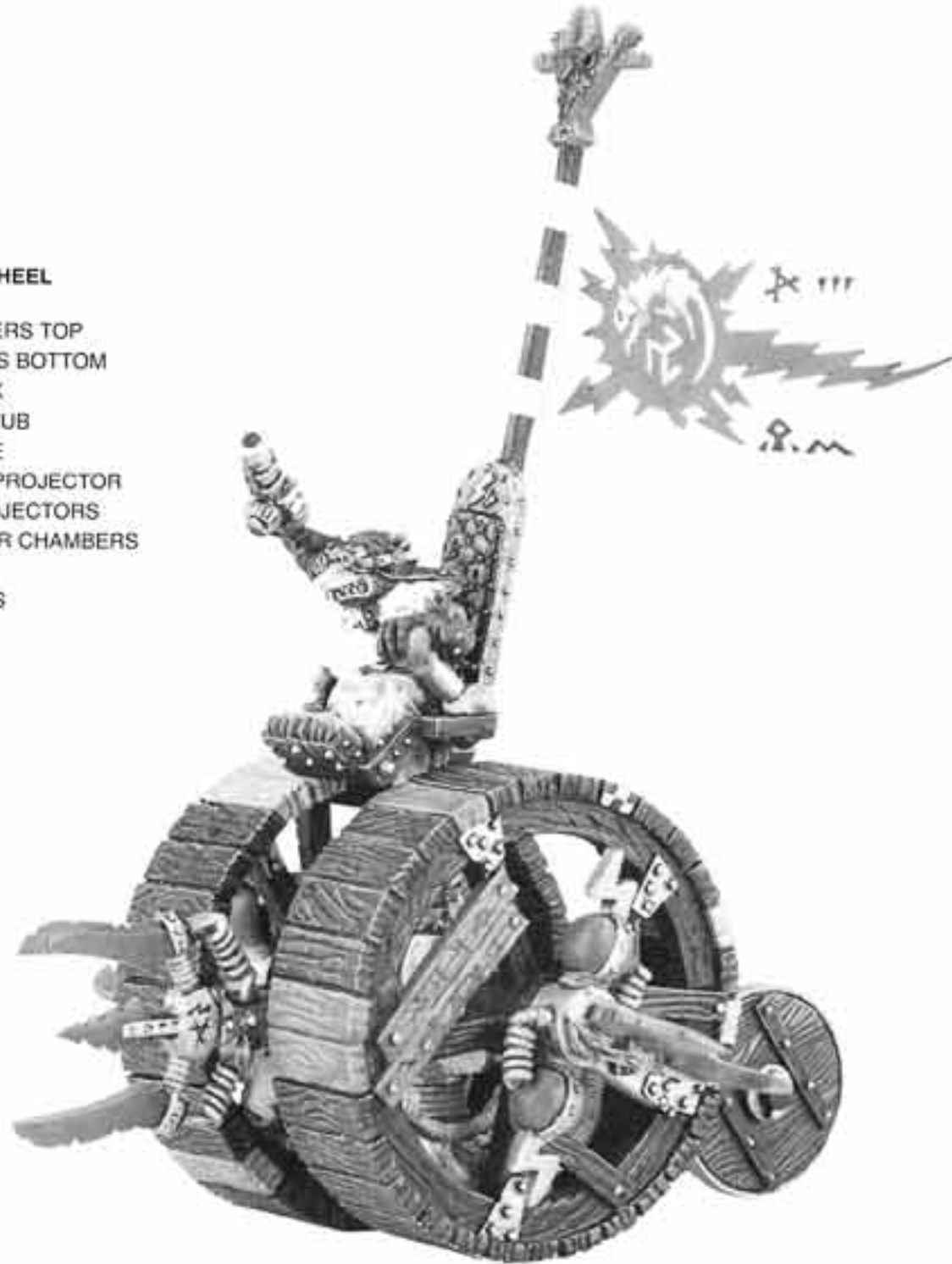

SKAVEN DOOMWHEEL

Designed by Jes Goodwin and Norman Swales



UNDEAD

SKELETON WARRIORS REGIMENT

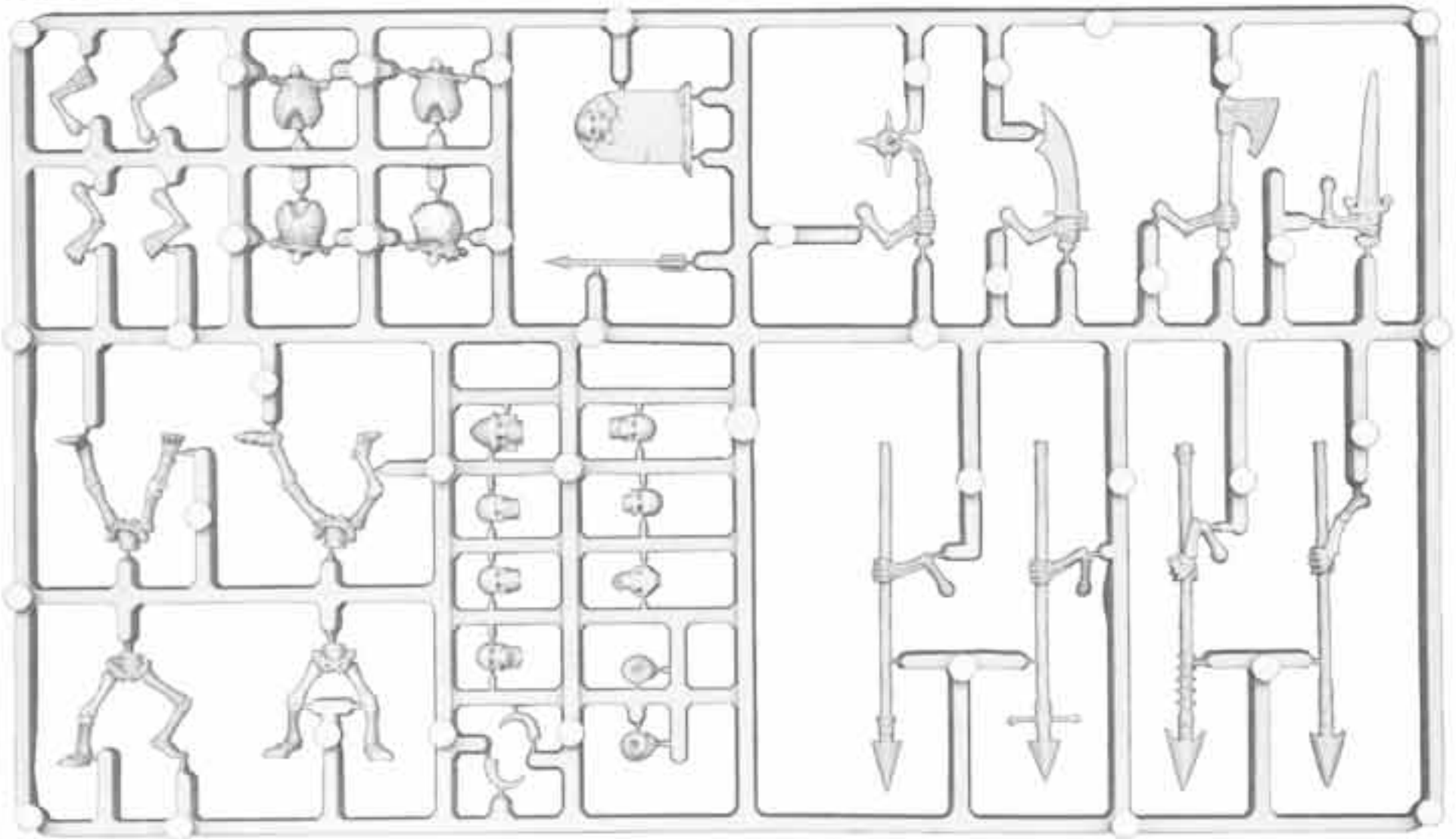

SKELETON WARRIORS SPRUE
(SPRUE SHOWN AT 75% ACTUAL SIZE)
99380207001

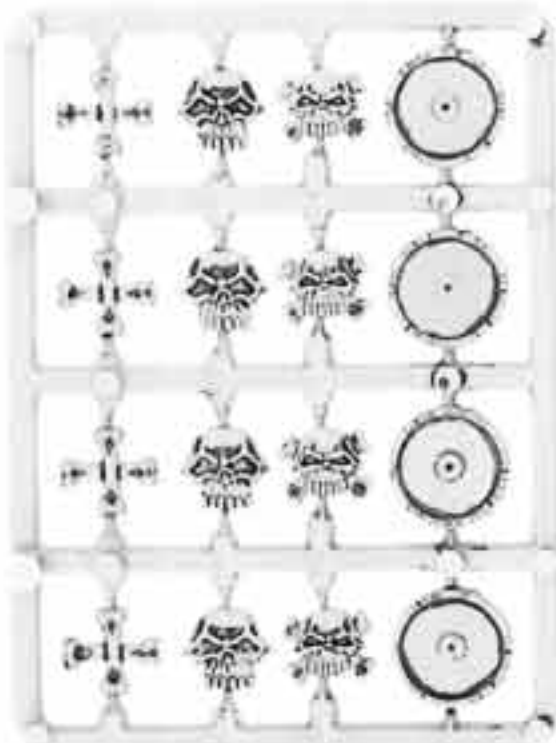

SKELETON WARRIORS SHIELD SPRUE
(SPRUE SHOWN AT 75% ACTUAL SIZE)
99360299001



HORN
020704204



LEADER'S HEAD
020704201

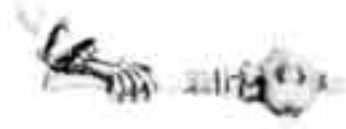

MACE
020704202



STANDARD POLE
020704203



STANDARD TOP
020704205

SHOWN BELOW ARE SOME OF THE MANY WAYS YOU CAN ASSEMBLE YOUR SKELETON WARRIORS



THE BOXED SET CONSISTS OF:

5 X SKELETON WARRIORS SPRUES, 5 X SHIELD SPRUES, 1 X HORN, 1 X LEADER'S HEAD, 1 X MACE, 1 X STANDARD POLE, 1 X STANDARD TOP, 1 X MOVEMENT TRAY

YOU GET ENOUGH PLASTIC SPRUES AND METAL ACCESSORIES FOR A COMPLETE REGIMENT OF 20 SKELETON WARRIORS INCLUDING A COMMAND GROUP

Models designed by Aly Morrison and Colin Dixon

483

Not suitable for children under 8 years due to small parts and essential pointed components. All models supplied unpainted.

© Copyright Games Workshop Ltd. 1998. All rights reserved.



UNDEAD

SKELETON WARRIORS

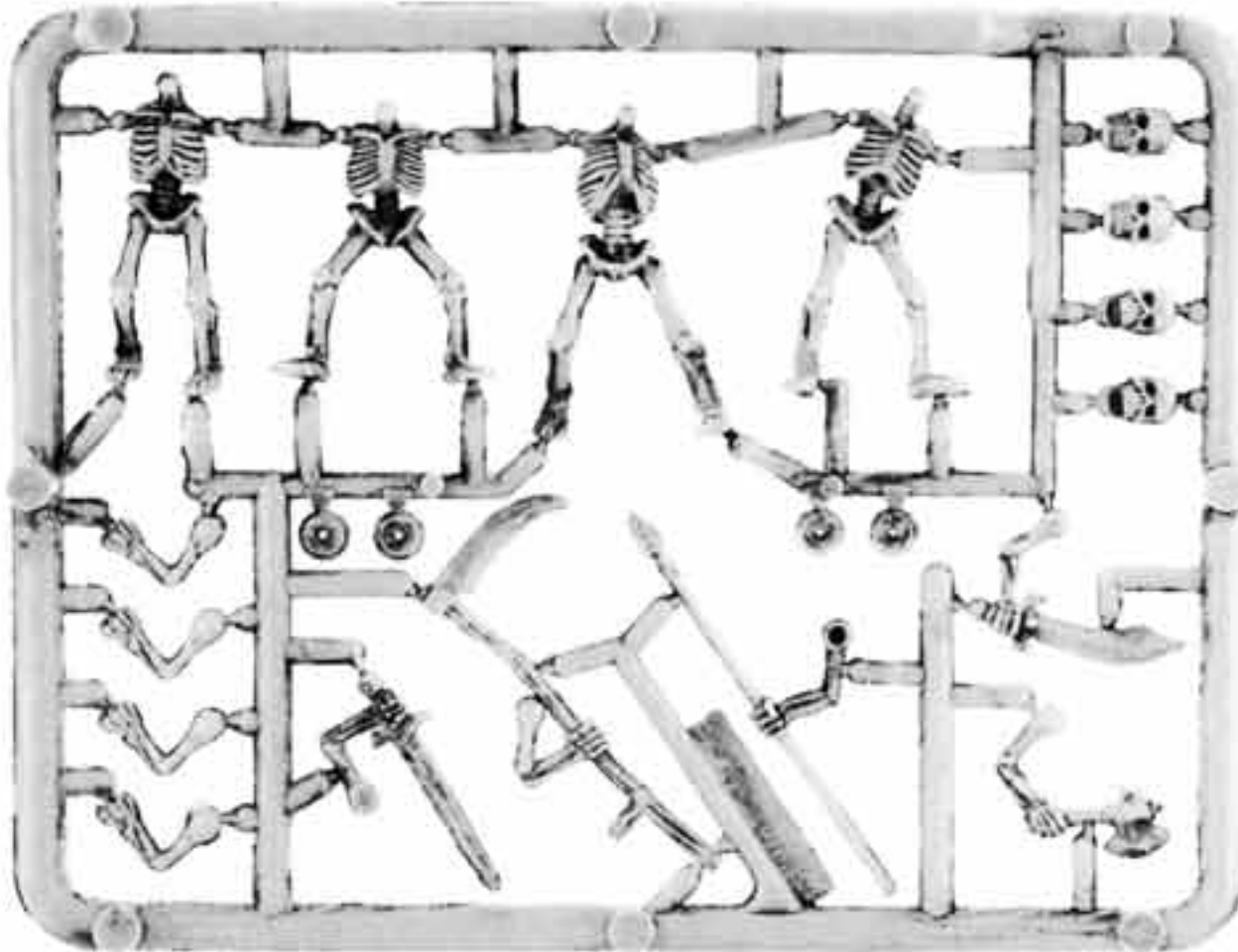

SKELETON WARRIORS SPRUE 101462

THESE FIGURES ARE SUPPLIED WITH A PLASTIC SHIELD SPRUE AS STANDARD



SKELETON WARRIOR



SKELETON WARRIOR

SKELETON HORSEMEN

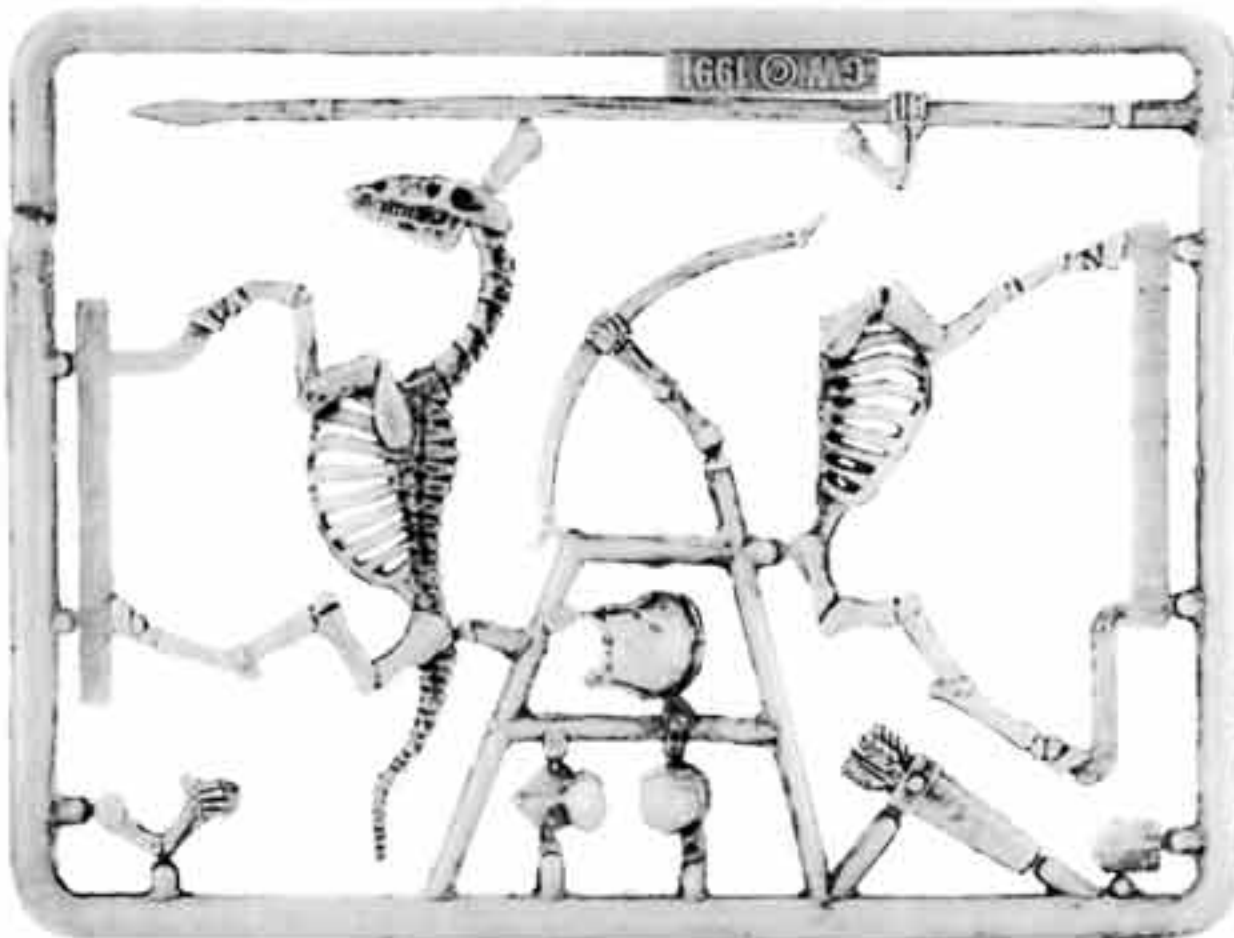

SKELETON HORSE SPRUE 129843

THE COMPLETE SKELETON HORSEMAN
CONSISTS OF:
1 x PLASTIC SKELETON WARRIOR SPRUE
1 x PLASTIC SKELETON HORSE SPRUE
1 x PLASTIC SHIELD SPRUE

NOTE: ONLY THREE OF THE FOUR
PLASTIC SKELETON WARRIOR BODIES
CAN BE MOUNTED ON THE HORSE

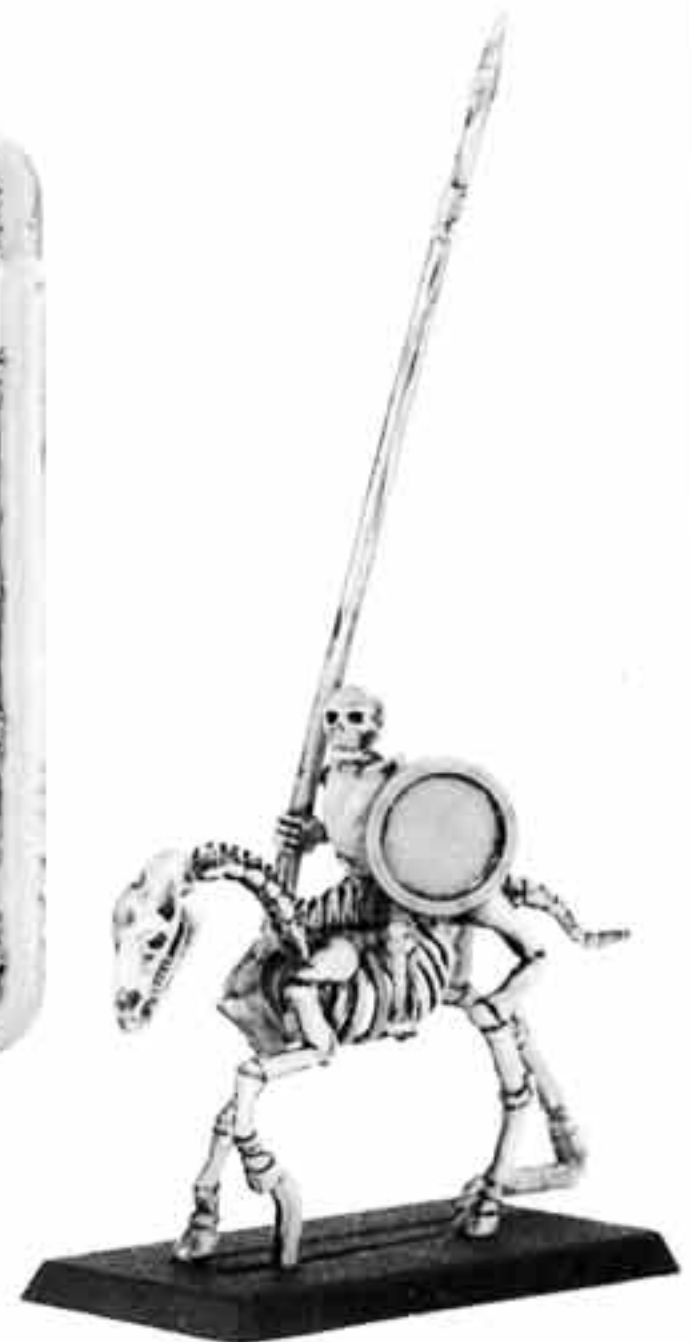

SKELETON HORSEMAN



UNDEAD

UNDEAD CHARIOT

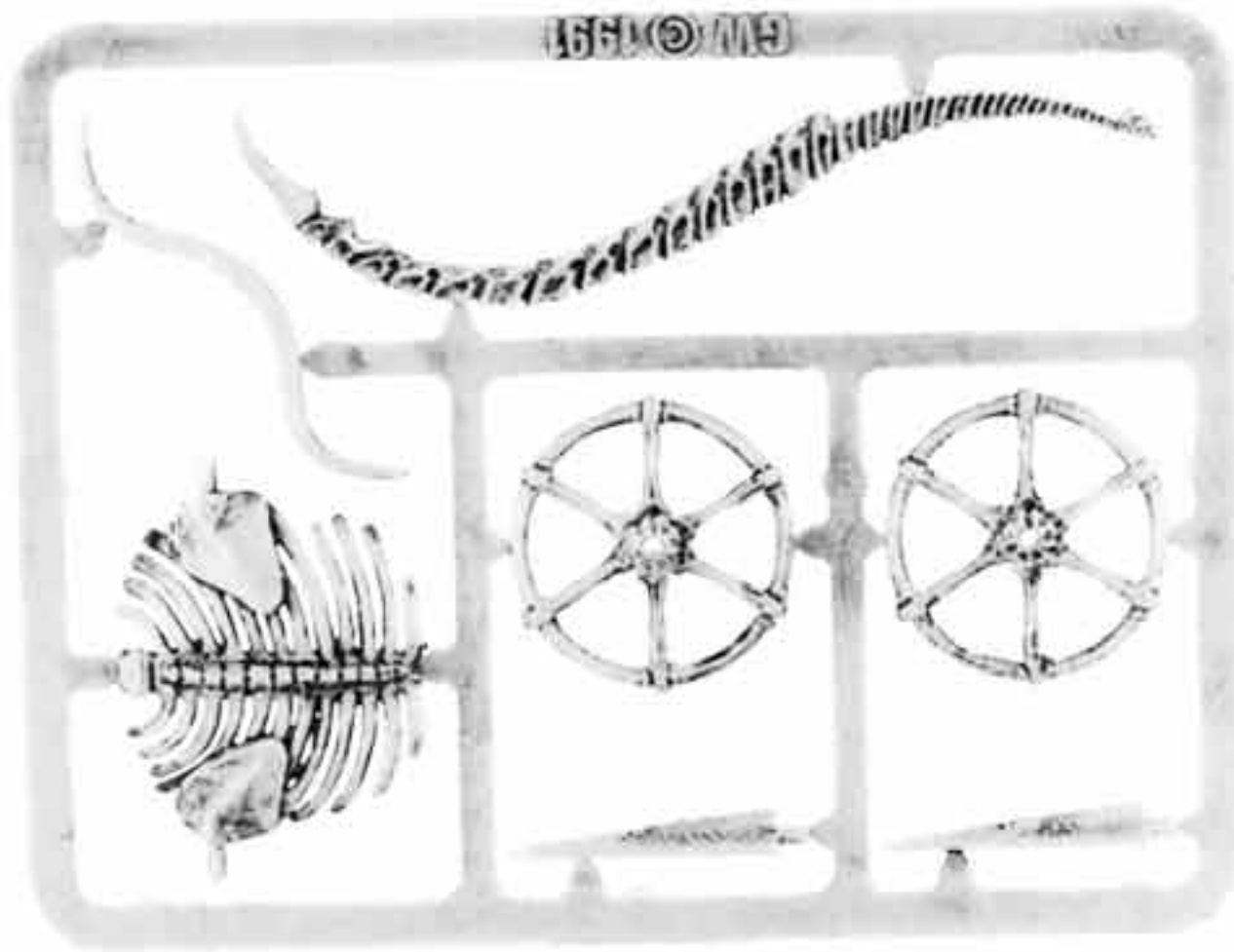

UNDEAD CHARIOT SPRUE 131769

THE COMPLETE UNDEAD CHARIOT
CONSISTS OF:
1 x PLASTIC SKELETON WARRIOR SPRUE
2 x PLASTIC SKELETON HORSE SPRUES
1 x PLASTIC UNDEAD CHARIOT SPRUE
1 x PLASTIC SHIELD SPRUE

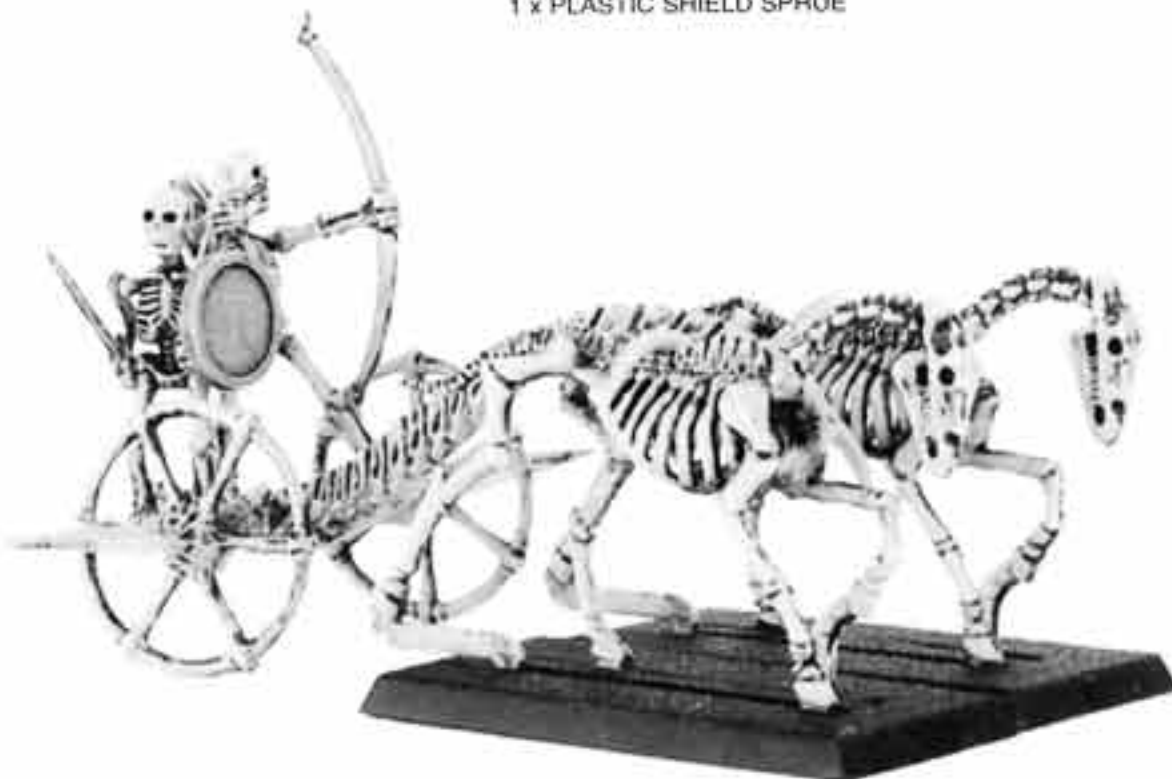

UNDEAD CHARIOT



CITADEL
MINIATURES



CITADEL
MINIATURES

UNDEAD

ARMOURED SKELETON COMMAND



ARMOURED WIGHT
CHAMPION
020703701



ARMOURED SKELETON
DRUMMER
020703802



ARMOURED SKELETON
STANDARD BEARER
020703801



ARMOURED WIGHT
CHAMPION

A COMPLETED ARMOURED
WIGHT CHAMPION CONSISTS OF:
1 x ARMOURED SKELETON WIGHT
CHAMPION
1 x PLASTIC SHIELD

A COMPLETED ARMOURED
SKELETON STANDARD BEARER
CONSISTS OF:
1 x ARMOURED SKELETON
STANDARD BEARER
1 x PLASTIC SHIELD

ARMOURED SKELETONS



ARMOURED SKELETON
WITH SPEAR 1
020703601



ARMOURED SKELETON
WITH SPEAR 2
020703602



ARMOURED SKELETON
WITH SPEAR 3
020703603



ARMOURED SKELETON
WITH SPEAR 4
020703604



ARMOURED SKELETON
WITH SPEAR 5
020703605



A COMPLETED ARMOURED
SKELETON CONSISTS OF:
1 x ARMOURED SKELETON
WITH SPEAR
1 x PLASTIC SHIELD



UNDEAD

WIGHTS



WIGHT 1
020700604



WIGHT 2
020700603



WIGHT 3
020700602



WIGHT 4
020700601



WIGHT 5
020700607



WIGHT 6
020700605



WIGHT 7
020700608



WIGHT 8
020700606

THESE MODELS ARE SUPPLIED WITH PLASTIC SHIELDS WHERE APPROPRIATE



UNDEAD WIGHTS



CITADEL
MINIATURES

Designed by Gary Morley

487

Not suitable for children under 36 months due to small parts and essential pointed components. All models supplied unpainted.
© Copyright Games Workshop Ltd., 1997. All rights reserved.

UNDEAD

MUMMIES



MUMMY 2
020702204



MUMMY 1
020702203



MUMMY 3
020702202



MUMMY 4
020702206



MUMMY 5
020702207



MUMMY 6
020702201



MUMMY 7
020702208



MUMMY 8
020702205

WRAITHS



WRAITH 6
020700706



WRAITH 7
020700707



WRAITH 5
020700705



WRAITH 3
020700703



WRAITH 4
020700704



WRAITH 2
020700702



WRAITH 8
020700708



UNDEAD

WIGHTS ON SKELETON STEEDS



MOUNTED WIGHT BODY 1
020702701



MOUNTED WIGHT BODY 2
020702702



MOUNTED WIGHT BODY 3
020702703



MOUNTED WIGHT BODY 4
020702704



MOUNTED WIGHT SPEAR 1
020702705



MOUNTED WIGHT SPEAR 2
020702706



MOUNTED WIGHT SPEAR 3
020702707



MOUNTED WIGHT SPEAR 4
020702708



MOUNTED WIGHT SHIELD 1
020702709



MOUNTED WIGHT SHIELD 2
020702710



MOUNTED WIGHT SWORD
020702711

A COMPLETE MOUNTED WIGHT CONSISTS OF:

- 1 x MOUNTED WIGHT BODY
- 1 x MOUNTED WIGHT SPEAR
- 1 x MOUNTED WIGHT SHIELD
- 1 x MOUNTED WIGHT SWORD
- 1 x PLASTIC SKELETON STEED

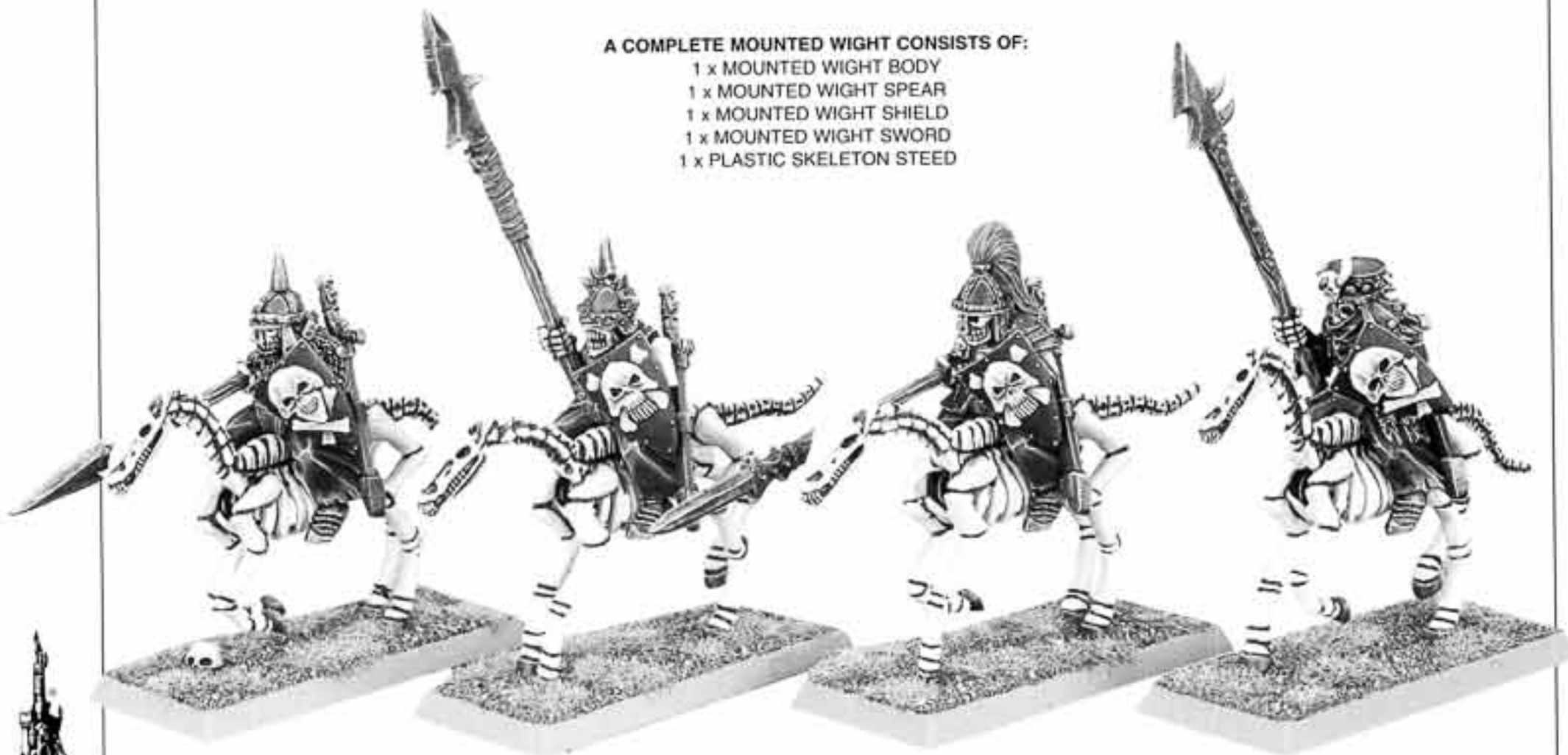

WIGHTS ON SKELETON STEEDS

Designed by Aly Morrison

Not suitable for children under 36 months due to small parts and essential pointed components. All models supplied unpainted.
© Copyright Games Workshop Ltd., 1997. All rights reserved.

UNDEAD

WIGHTS ON SKELETON STEEDS COMMAND



**MOUNTED WIGHT
STANDARD BEARER**
020703401



**MOUNTED WIGHT
HORN BLOWER**
020703501



MOUNTED WIGHT HORN
020703502



MOUNTED WIGHT SWORD
020702711



**MOUNTED WIGHT STANDARD
BEARER HELMET WINGS**
020703402

**RIGHT HELMET
WING**

**LEFT HELMET
WING**



**MOUNTED WIGHT
CHAMPION**
020703301



**MOUNTED WIGHT STANDARD
BEARER BANNER POLE**
020703403



MOUNTED WIGHT SHIELD 1
020702709



**MOUNTED WIGHT STANDARD BEARER
BANNER TOP**
020703404



MOUNTED WIGHT SHIELD 2
020702710

**A COMPLETED WIGHT
STANDARD BEARER ON SKELETON STEED
CONSISTS OF:**

- 1 x MOUNTED WIGHT STANDARD BEARER
- 1 x MOUNTED WIGHT BANNER POLE
- 1 x MOUNTED WIGHT BANNER TOP
- 1 x SET OF MOUNTED WIGHT HELMET WINGS
- 1 x MOUNTED WIGHT SHIELD
- 1 x MOUNTED WIGHT SWORD
- 1 x PLASTIC SKELETON STEED

**A COMPLETED WIGHT
CHAMPION ON SKELETON STEED
CONSISTS OF:**

- 1 x MOUNTED WIGHT CHAMPION
- 1 x MOUNTED WIGHT SHIELD
- 1 x MOUNTED WIGHT SWORD
- 1 x PLASTIC SKELETON STEED

**A COMPLETED WIGHT
HORN BLOWER ON SKELETON STEED
CONSISTS OF:**

- 1 x MOUNTED WIGHT HORN BLOWER
- 1 x MOUNTED WIGHT HORN
- 1 x MOUNTED WIGHT SHIELD
- 1 x MOUNTED WIGHT SWORD
- 1 x PLASTIC SKELETON STEED



WIGHTS ON SKELETON STEEDS COMMAND

Designed by Aly Morrison



UNDEAD

NECROMANCERS



NECROMANCER 1
020701001



NECROMANCER 2
020701002



NECROMANCER 3
079901011



CARRION



CARRION HEAD 1
020701403



CARRION HEAD 2
020701404



CARRION HEAD 3
020701405



CARRION RIDER 1
020701407



CARRION RIDER 2
020701406



CARRION BODY
020701401

A COMPLETE CARRION CONSISTS OF:

- 1 x CARRION HEAD
- 1 x CARRION RIDER
- 1 x CARRION BODY
- 1 x CARRION WINGS



CARRION WINGS
020701402



CARRION WITH UNDEAD RIDER



CITADEL
MINIATURES

Designed by Gary Morley and Trish Morrison

Not suitable for children under 8 years due to small parts and essential pointed components. All models supplied unpainted.
© Copyright Games Workshop Ltd. 1998. All rights reserved.

UNDEAD

MOUNTED NECROMANCER

THIS MODEL IS SUPPLIED WITH A CAPARISONED HORSE SPRUE AS STANDARD



NECROMANCER TORSO
020701201



NECROMANCER LEGS
020701202

A COMPLETE MOUNTED
NECROMANCER
CONSISTS OF:
1 x NECROMANCER TORSO
1 x NECROMANCER LEGS
1 x CAPARISONED HORSE SPRUE



MOUNTED NECROMANCER

Designed by Gary Morley



UNDEAD

VAMPIRE LORD



VAMPIRE LORD SKELETON STEED LEFT SIDE
020702803



VAMPIRE LORD
020702801



VAMPIRE LORD



VAMPIRE LORD SKELETON STEED RIGHT SIDE
020702804



VAMPIRE LORD CLOAK
020702802

A COMPLETE VAMPIRE LORD CONSISTS OF:
1 x VAMPIRE LORD
1 x VAMPIRE LORD CLOAK
1 x VAMPIRE LORD SKELETON STEED LEFT SIDE
1 x VAMPIRE LORD SKELETON STEED RIGHT SIDE

BAT SWARM



BAT 1
020703101



BAT 2
020703102



BAT 3
020703103



BAT 4
020703104



BAT 5
020703105

A Bat Swarm consists of
any 5 Bats supplied with a
40mm Monster Base

WRAITH CHAMPION



WRAITH CHAMPION
020703001

Vampire Lord and Wraith Champion designed by Aly Morrison, Bat Swarm designed by Trish Morrison

Not suitable for children under 8 years due to small parts and essential pointed components. All models supplied unpainted.
© Copyright Games Workshop Ltd. 1998. All rights reserved.

UNDEAD

WIGHT LORD



WIGHT LORD SKELETON STEED LEFT SIDE
020702903



WIGHT LORD SKELETON STEED RIGHT SIDE
020702904

A COMPLETE WIGHT LORD
CONSISTS OF:
1 x WIGHT LORD
1 x WIGHT LORD SHIELD
1 x WIGHT LORD SKELETON STEED
LEFT SIDE
1 x WIGHT LORD SKELETON STEED
RIGHT SIDE



WIGHT LORD



WIGHT LORD
020702901



WIGHT LORD SHIELD
020702902



UNDEAD

KRELL, LORD OF THE UNDEAD

THE COMPLETE KRELL
CONSISTS OF:
1 x KRELL'S BODY
1 x KRELL'S BANNER POLE



KRELL'S BODY
020701701



KRELL'S BANNER POLE
020701702



KRELL, LORD OF THE UNDEAD

VAMPIRE

A COMPLETE VAMPIRE
CONSISTS OF:
1 x VAMPIRE BODY
1 x VAMPIRE CLOAK



VAMPIRE BODY
020700901



VAMPIRE CLOAK
020700902



VAMPIRE

HEINRICH KEMMLER, THE LICHEMASTER



HEINRICH KEMMLER,
THE LICHEMASTER
020701301

ISABELLA VON CARSTEIN



ISABELLA VON CARSTEIN
020701601

VLAD VON CARSTEIN



VLAD VON CARSTEIN
020701602



Designed by Gary Morley

Not suitable for children under 8 years due to small parts and essential pointed components. All models supplied unpainted.
© Copyright Games Workshop Ltd. 1998. All rights reserved.

WOOD ELVES

WOOD ELF ARCHERS



WOOD ELF ARCHER 1
020401811



WOOD ELF ARCHER
WITH SWORD 1
020401809



WOOD ELF ARCHER
WITH SWORD 2
020401810



WOOD ELF ARCHER 2
020401812



WOOD ELF ARCHER 3
020401813



WOOD ELF ARCHER 4
020401804



WOOD ELF ARCHER 5
020401807



WOOD ELF ARCHER 6
020401802



WOOD ELF ARCHER 7
020401806



WOOD ELF ARCHER 8
020401803



WOOD ELF ARCHER
WITH SWORD 3
020401805



WOOD ELF ARCHER 9
020401808



CITADEL
MINIATURES



CITADEL
MINIATURES

WOOD ELVES

GLADE GUARD



GLADE GUARD 1
020402301



GLADE GUARD 2
020402302



GLADE GUARD 3
020402303



GLADE GUARD 4
020402304



GLADE GUARD 5
020402305



GLADE GUARD 6
020402306



GLADE GUARD 7
020402307



GLADE GUARD 8
020402308



GLADE GUARD 9
020402309



GLADE GUARD 10
020402310



GLADE GUARD 11
020402311



GLADE GUARD 12
020402312

A COMPLETE GLADE GUARD
CONSISTS OF:
1 x GLADE GUARD
1 x PLASTIC ELF SHIELD



PLASTIC ELF SHIELD SPRUE
101635



GLADE GUARD



Designed by Aly Morrison

WOOD ELVES

WOOD ELF COMMAND GROUPS



CHAMPION WITH SPEAR
020400602



CHAMPION WITH BOW
020400601



HORNBLOWER WITH SPEAR
020400504



HORNBLOWER WITH BOW
020400503



A COMPLETE WOOD ELF
STANDARD BEARER
CONSISTS OF:
1 x STANDARD BEARER
1 x BANNER TOP



STANDARD BEARER 2
020400506



WOOD ELF STANDARD BEARER



STANDARD BEARER 1
020400505



STANDARD TOP 2
020400508



STANDARD TOP 1
020400507



STANDARD TOP 3
020400509



WOOD ELVES

WARDANCERS



WARDANCER 1
020402102



WARDANCER 2
020402101



WARDANCER 3
020402103



WARDANCER 4
020402104

PLASTIC WOOD ELF



PLASTIC WOOD ELF SPRUE
102728



WARDANCER 5
020402105



WARDANCER 6
020402106



WARDANCER 7
020402107



PLASTIC WOOD ELF



WARDANCER 8
020402108

WARDANCER CHAMPION



WARDANCER CHAMPION
079901501



Wardancers designed by Gary Morley, Wardancer Champion designed by Jes Goodwin, plastic Wood Elf designed by Aly Morrison

Not suitable for children under 8 years due to small parts and essential pointed components. All models supplied unpainted.
© Copyright Games Workshop Ltd. 1998. All rights reserved.

WOOD ELVES

WOOD ELF SORCERESS ON FOOT



WOOD ELF SORCERESS ON FOOT
020402801

WOOD ELF SCOUT COMMAND



WOOD ELF SCOUT
CHAMPION
020402801



WOOD ELF SCOUT
HORN BLOWER
020402902



WOOD ELF SCOUT
STANDARD BEARER
020402901

WOOD ELF SCOUTS



WOOD ELF SCOUT 1
020402701



WOOD ELF SCOUT 2
020402702



WOOD ELF SCOUT 3
020402703



WOOD ELF SCOUT 4
020402704



WOOD ELF SCOUT 5
020402705



WOOD ELF SCOUT 6
020402706



WOOD ELVES

GLADE RIDERS



GLADE RIDER ARCHER BODY 1
020401201



GLADE RIDER ARCHER BODY 2
020401203



GLADE RIDER ARCHER LEGS 2
020401204



GLADE RIDER ARCHER LEGS 1
020401202



GLADE RIDER CHAMPION
020401001



ELF SHIELD SPRUE
101635

A COMPLETE GLADE RIDER CHAMPION CONSISTS OF:
1 x GLADE RIDER CHAMPION
1 x PLASTIC ELVEN STEED
1 x ELF SHIELD SPRUE



GLADE RIDER BODY 1
020402501



GLADE RIDER BODY 2
020402503



GLADE RIDER LANCE 1
020402502



GLADE RIDER LANCE 2
020402504

A COMPLETE GLADE RIDER ARCHER CONSISTS OF:
1 x GLADE RIDER ARCHER LEGS
1 x GLADE RIDER ARCHER BODY
1 x PLASTIC ELVEN STEED



GLADE RIDER WITH LONG BOW

A COMPLETE GLADE RIDER CONSISTS OF:
1 x GLADE RIDER BODY
1 x GLADE RIDER LANCE
1 x PLASTIC ELVEN STEED
1 x ELF SHIELD SPRUE



GLADE RIDER WITH LANCE



CITADEL
MINIATURES



CITADEL
MINIATURES

Glade Riders designed by Gary Morley

Not suitable for children under 8 years due to small parts and essential pointed components. All models supplied unpainted.
© Copyright Games Workshop Ltd. 1998. All rights reserved.

WOOD ELVES

WOOD ELF GENERAL

A COMPLETED WOOD ELF GENERAL
CONSISTS OF:
1 x WOOD ELF GENERAL'S BODY
1 x WOOD ELF GENERAL'S LANCE
1 x PLASTIC ELVEN STEED



WOOD ELF GENERAL'S BODY
020400701



WOOD ELF GENERAL'S LANCE
020400702

WOOD ELF MAGE

A COMPLETED
WOOD ELF MAGE
CONSISTS OF:
1 x WOOD ELF MAGE
1 x PLASTIC ELVEN STEED



WOOD ELF MAGE
020400901

WOOD ELF GLADE RIDER HORNBLOWER

A COMPLETED WOOD ELF GLADE
RIDER HORNBLOWER CONSISTS OF:
1 x WOOD ELF
GLADE RIDER
HORNBLOWER BODY
1 x WOOD ELF
GLADE RIDER LEGS
1 x PLASTIC ELVEN STEED



WOOD ELF GLADE RIDER
HORNBLOWER BODY
020401401



WOOD ELF GLADE RIDER
HORNBLOWER LEGS
020401402

WOOD ELF GLADE RIDER STANDARD BEARER

A COMPLETED WOOD ELF
GLADE RIDER STANDARD BEARER
CONSISTS OF:
1 x WOOD ELF GLADE RIDER
STANDARD BEARER
1 x PLASTIC ELVEN STEED
1 x PLASTIC ELF SHIELD SPRUE



WOOD ELF GLADE RIDER
STANDARD BEARER
020401301



WOOD ELF GLADE RIDER
STANDARD BEARER



WOOD ELVES

WOOD ELF WARHAWK RIDERS



WOOD ELF WARHAWK RIDER

A COMPLETE WARHAWK RIDER
CONSISTS OF:
1 x COMPLETE WARHAWK RIDER
1 x WARHAWK LEFT WING
1 x WARHAWK RIGHT WING
1 x WARHAWK BODY
1 x WARHAWK TAIL



WARHAWK RIDER
CHAMPION BODY
020401111



WARHAWK RIDER LEGS
020401112



WARHAWK RIDER
020401101



WARHAWK RIDER
ARCHER BODY
020401113



WARHAWK RIDER SPEAR
020401102



WARHAWK LEFT WING
020401103



WARHAWK RIGHT WING
020401104

NOTE: THE WARHAWK HEADS
AND TAILS ARE NOT
INTERCHANGEABLE

WARHAWK A

WARHAWK BODY A
020401105

WARHAWK TAIL A
020401106

WARHAWK B

WARHAWK BODY B
020401107

WARHAWK TAIL B
020401108

WARHAWK C

WARHAWK BODY C
020401109

WARHAWK TAIL C
020401110

FLYING BASE

Warhawk Riders designed by Gary Morley, Warhawk designed by Trish Morrison

Not suitable for children under 36 months due to small parts and essential pointed components. All models supplied unpainted.
© Copyright Games Workshop Ltd., 1997. All rights reserved.



WOOD ELVES

WOOD ELF MAGE ON WARHAWK



WARHAWK MAGE
020403001



WOOD ELF MAGE ON WARHAWK

A COMPLETE WOOD ELF MAGE ON WARHAWK CONSISTS OF:

- 1 x WARHAWK MAGE
- 1 x WARHAWK LEFT WING
- 1 x WARHAWK RIGHT WING
- 1 x WARHAWK BODY
- 1 x WARHAWK TAIL



WARHAWK LEFT WING
020401103



WARHAWK RIGHT WING
020401104

WARHAWK A



WARHAWK BODY A
020401105



WARHAWK TAIL A
020401106

WARHAWK B



WARHAWK BODY B
020401107



WARHAWK TAIL B
020401108

WARHAWK C



WARHAWK BODY C
020401109



WARHAWK TAIL C
020401110

NOTE: THE WARHAWK HEADS AND TAILS ARE NOT INTERCHANGEABLE



FLYING BASE



WOOD ELVES

GREAT EAGLE



WOOD ELF GREAT EAGLE

A COMPLETED GREAT EAGLE
CONSISTS OF:
1 x EAGLE HEAD
1 x EAGLE TAIL
1 x LEFT EAGLE WING
1 x RIGHT EAGLE WING
1 x FLYING BASE

NOTE: THE EAGLE HEADS
AND TAILS ARE NOT
INTERCHANGEABLE



LEFT EAGLE WING 1
020400807



RIGHT EAGLE WING 1
020400808



LEFT EAGLE WING 2
020400809



RIGHT EAGLE WING 2
020400810

GREAT EAGLE 1



EAGLE HEAD 1
020400801

GREAT EAGLE 2



EAGLE HEAD 2
020400803

GREAT EAGLE 3



EAGLE HEAD 3
020400805



EAGLE TAIL 1
020400802



EAGLE TAIL 2
020400804



EAGLE TAIL 3
020400806



Designed by Trish Morrison

WOOD ELVES

TREEMEN

A TREEMAN CONSISTS OF:
1 x TREEMAN BODY
1 x TREEMAN RIGHT ARM
1 x TREEMAN LEFT ARM

NOTE: THE ARMS OF
TREEMAN A AND B ARE NOT
INTERCHANGEABLE



WOOD ELF TREEMAN



TREEMAN A BODY
020401701



TREEMAN A RIGHT ARM
020401702



TREEMAN A LEFT ARM
020401703



TREEMAN B BODY
020401704



TREEMAN B RIGHT ARM
020401706



TREEMAN B LEFT ARM
020401705



WOOD ELVES

SKAW THE FALCONER

A COMPLETED SKAW THE FALCONER
CONSISTS OF :
1 X SKAW
1 X FALCON 1
1 X FALCON 2



SKAW
020401601



FALCON 1
020401602



FALCON 2
020401603



SKAW THE FALCONER

WOOD ELF WAYWATCHERS



WAYWATCHER 1
020401501



WAYWATCHER 2
020401502



WAYWATCHER 3
020401503



WAYWATCHER 4
020401504



WAYWATCHER 5
020401505



WAYWATCHER 6
020401506



Designed by Gary Morley

507

Not suitable for children under 36 months due to small parts and essential pointed components. All models supplied unpainted.
© Copyright Games Workshop Ltd., 1997. All rights reserved.

WOOD ELVES

WOOD ELF FOREST DRAGON

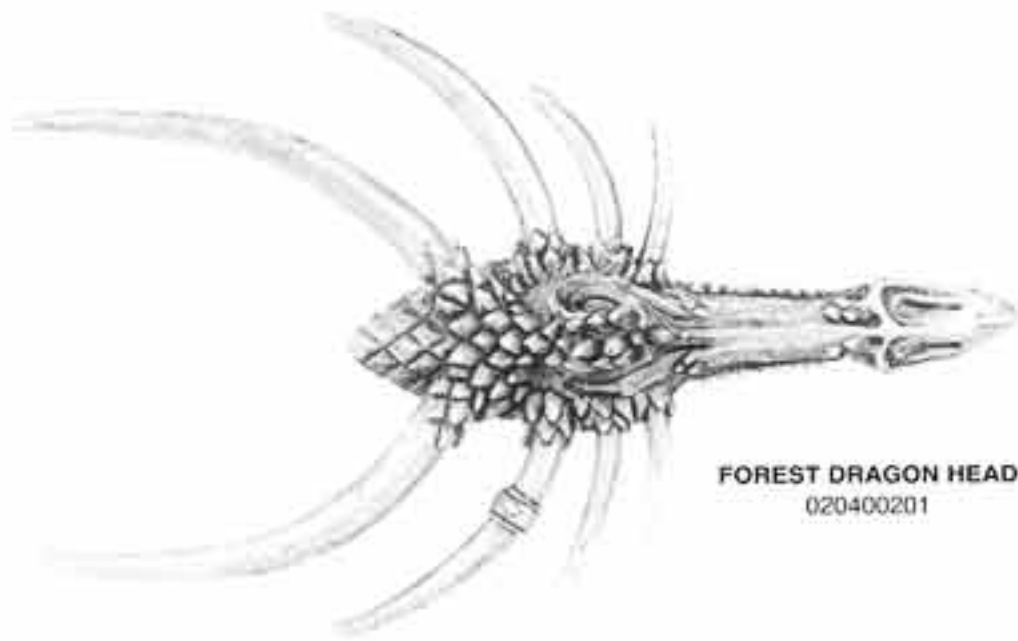

FOREST DRAGON HEAD
020400201



WOOD ELF LORD
BODY
020400215



WOOD ELF LORD
SWORD
020400216



WOOD ELF LORD
SHIELD
020400217



FOREST DRAGON NECK
020400203



WOOD ELF LORD LEFT LEG
020400214



WOOD ELF LORD RIGHT LEG
020400213



FOREST DRAGON BODY
020400204



WOOD ELF LORD LANCE
020400219



FOREST DRAGON LEFT LEG
020400209



FOREST DRAGON RIGHT LEG
020400205



FOREST DRAGON FOOT
020400208



WOOD ELF LORD SEAT BACK
020400218



FOREST DRAGON
TONGUE
020400202



FOREST DRAGON TAIL MIDDLE
020400212



FOREST DRAGON TAIL END
020400210



FOREST DRAGON TAIL BASE
020400211



FOREST DRAGON
RIGHT ARM
020400206



FOREST DRAGON
LEFT ARM
020400207



CITADEL
MINIATURES



CITADEL
MINIATURES

WOOD ELVES

WOOD ELF FOREST DRAGON



WOOD ELF FOREST DRAGON



A COMPLETED WOOD ELF FOREST DRAGON CONSISTS OF:

- 1 x FOREST DRAGON HEAD
- 1 x FOREST DRAGON TONGUE
- 1 x FOREST DRAGON NECK
- 1 x FOREST DRAGON BODY
- 1 x FOREST DRAGON LEFT LEG
- 1 x FOREST DRAGON RIGHT LEG
- 1 x FOREST DRAGON FOOT
- 1 x FOREST DRAGON TAIL BASE
- 1 x FOREST DRAGON TAIL MIDDLE
- 1 x FOREST DRAGON TAIL END
- 1 x FOREST DRAGON RIGHT ARM
- 1 x FOREST DRAGON LEFT ARM
- 1 x WOOD ELF LORD BODY
- 1 x WOOD ELF LORD SWORD
- 1 x WOOD ELF LORD SHIELD
- 1 x WOOD ELF LEFT LORD LEG
- 1 x WOOD ELF RIGHT LORD LEG
- 1 x WOOD ELF LORD LANCE
- 1 x WOOD ELF LORD SEAT BACK
- 1 x LEFT PLASTIC WING
- 1 x RIGHT PLASTIC WING
- 1 x ADHESIVE BANNER

Dragon designed by Trish Morrison and Wood Elf Lord designed by Gary Morley

Not suitable for children under 36 months due to small parts and essential pointed components. All models supplied unpainted.
© Copyright Games Workshop Ltd., 1997. All rights reserved.



WOOD ELVES

DURTHU THE TREEMAN



DURTHU HEAD
020401902



DURTHU BODY
020401901



DURTHU RIGHT LEG
020401904



DURTHU LEFT LEG
020401905



DURTHU RIGHT ARM
020401903



DURTHU LEFT ARM
020401906

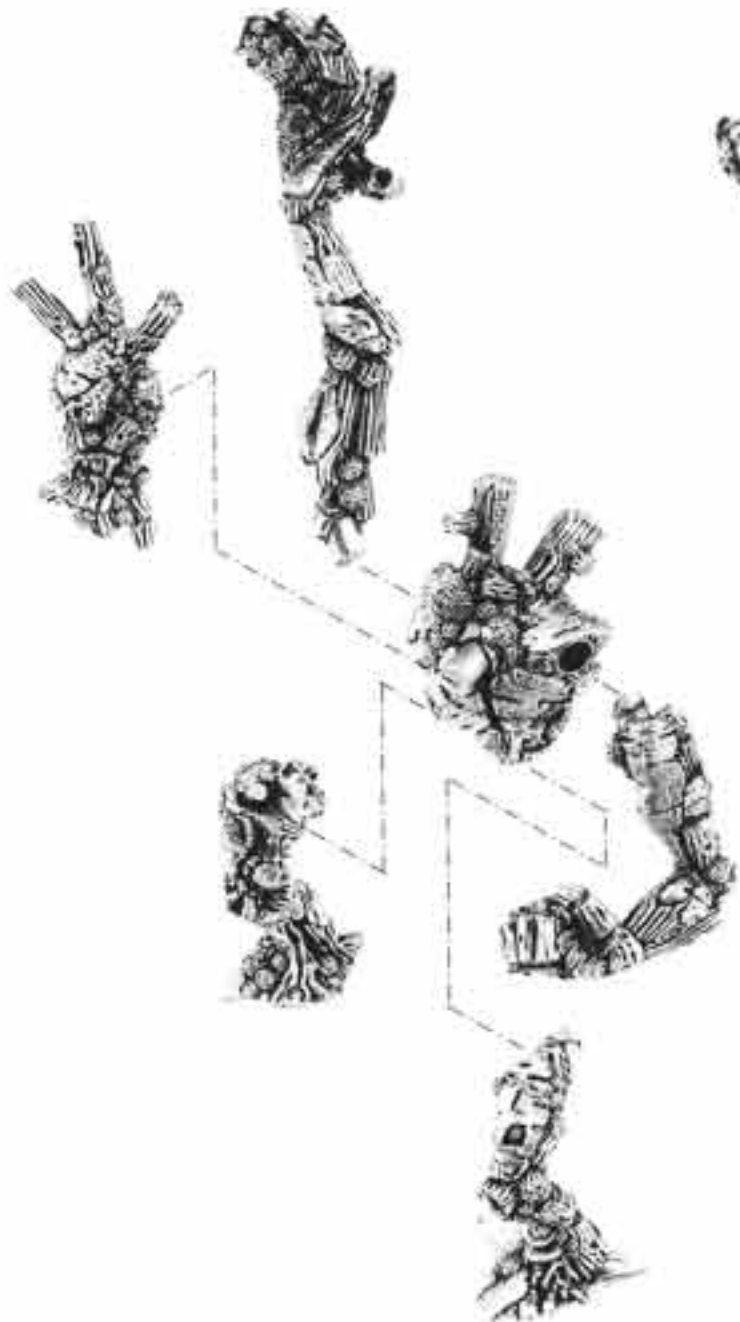

A COMPLETE DURTHU THE TREEMAN
CONSISTS OF:
1 x DURTHU HEAD
1 x DURTHU BODY
1 x DURTHU RIGHT ARM
1 x DURTHU LEFT ARM
1 x DURTHU RIGHT LEG
1 x DURTHU LEFT LEG



DURTHU THE TREEMAN



CITADEL
MINIATURES



CITADEL
MINIATURES

WOOD ELVES

ORION, KING IN THE WOODS



ORION, KING IN THE WOODS



ORION'S HEAD
020400302



ORION'S CLOAK
020400303



ORION'S HORN
020400306



SPEAR HEAD
020400304



ORION'S BODY
020400301



THE SPEAR OF KURNOUS
020400305

A COMPLETED ORION, KING IN THE WOODS CONSISTS OF:

- 1 x ORION'S HEAD
- 1 x ORION'S BODY
- 1 x ORION'S CLOAK
- 1 x ORION'S HORN
- 1 x SPEAR HEAD
- 1 x THE SPEAR OF KURNOUS

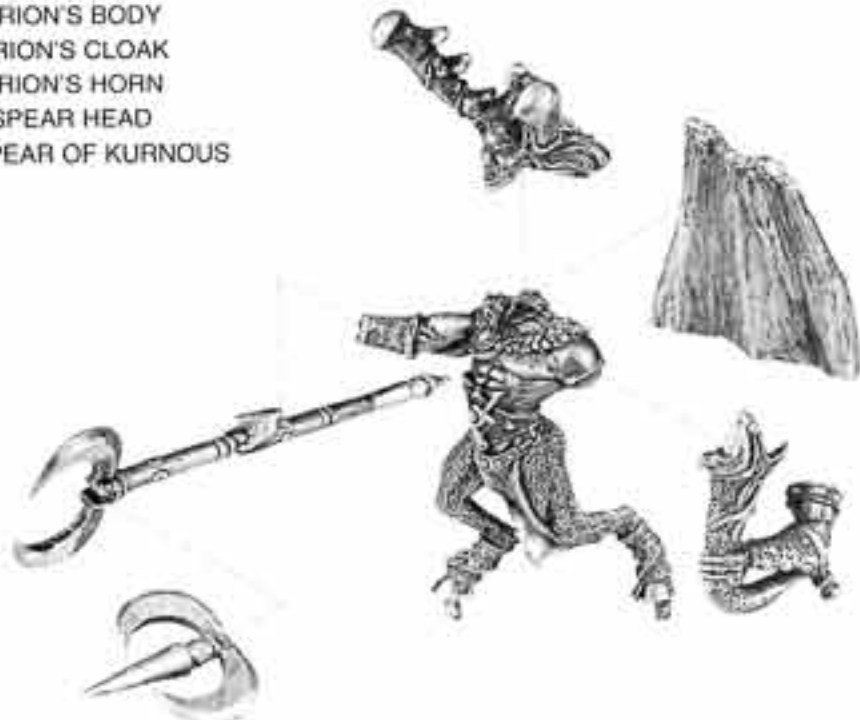

WOOD ELVES

ARIEL, MAGE QUEEN OF LOREN



ARIEL'S BODY
020400401



WAND OF WYCH ELM
020400402



A COMPLETED ARIEL, MAGE QUEEN OF LOREN

A COMPLETED ARIEL, MAGE QUEEN OF LOREN CONSISTS OF:

- 1 x ARIEL'S BODY
- 1 x WAND OF WYCH ELM
- 1 x ARIEL'S LEFT WING
- 1 x ARIEL'S RIGHT WING



ARIEL'S RIGHT WING
020400403



ARIEL'S LEFT WING
020400404



WOOD ELVES

DRYADS



DRYAD 1
020402001



DRYAD 2
020402002



DRYAD 3
020402003



DRYAD 4
020402004



DRYAD 5
020402005



DRYAD 6
020402006



DRYAD 7
020402007



DRYAD 8
020402008



Designed by Trish Morrison

Not suitable for children under 8 years due to small parts and essential pointed components. All models supplied unpainted.
© Copyright Games Workshop Ltd. 1998. All rights reserved.

BLOOD BOWL

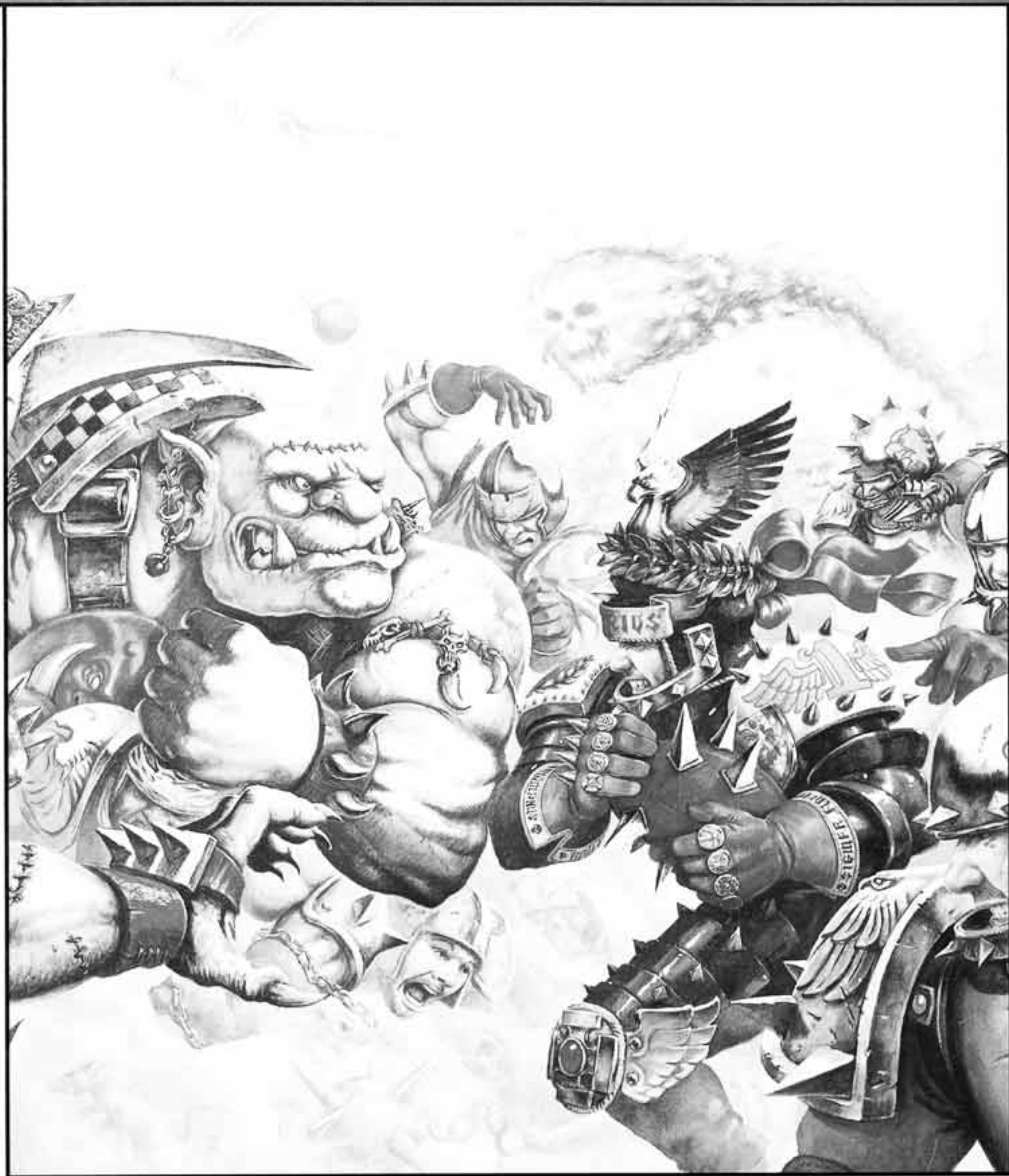

BLOOD BOWL

NORSE TEAM



NORSE THROWER
099903601



NORSE LINEMAN 1
099903602



NORSE LINEMAN 2
099903603



NORSE LINEMAN 3
099903604



NORSE CATCHER 1
099903605



NORSE CATCHER 2
099903606



NORSE BLITZER 1
099903607



NORSE BLITZER 2
099903608



Designed by Gary Morley

Not recommended for children under 8 years due to small parts and essential pointed components. All models supplied unpainted.
© Copyright Games Workshop Ltd. 1998. All rights reserved.

BLOOD BOWL

HUMAN TEAM



GRIFF OBERWALD
099900701



THE MIGHTY ZUG
099901301



HUMAN LINEMAN 1
099903701



HUMAN LINEMAN 2
099903702



HUMAN LINEMAN 3
099903703



HUMAN CATCHER 1
099903705



HUMAN CATCHER 2
099903704



HUMAN THROWER
099903706



HUMAN BLITZER 1
099903707



HUMAN BLITZER 2
099903708



HUMAN BLITZER 3
099903709

MORG 'N' THORG



MORG 'N' THORG HEAD
099900801

**A COMPLETE MORG 'N' THORG
CONSISTS OF:**

- 1 x MORG 'N' THORG BODY
- 1 x MORG 'N' THORG HEAD
- 1 x MORG 'N' THORG LEGS



MORG 'N' THORG BODY
099900802



MORG 'N' THORG LEGS
099900803



MORG 'N' THORG



BLOOD BOWL

RIPPER BOLGROT



RIPPER BOLGROT'S
TORSO
099902302



RIPPER BOLGROT'S
HEAD
099902301



RIPPER BOLGROT'S
LEGS
099902304



RIPPER BOLGROT'S
ARM
099902303

A COMPLETE RIPPER BOLGROT
CONSISTS OF:
1 x RIPPER BOLGROT'S TORSO
1 x RIPPER BOLGROT'S HEAD
1 x RIPPER BOLGROT'S LEGS
1 x RIPPER BOLGROT'S ARM



RIPPER BOLGROT

ORC TEAM



ORC LINEMAN 1
099900307



ORC LINEMAN 2
099900308



ORC LINEMAN 3
099900309



ORC BLITZER 1
099900303



ORC BLITZER 2
099900304



ORC BLITZER 3
099900305



ORC BLOCKER 1
099900301



ORC THROWER
099900306



ORC BLOCKER 2
099900302



VARAG GHOUL-CHEWER
099901401



Designed by Gary Morley

Not recommended for children under 8 years due to small parts and essential pointed components. All models supplied unpainted.
© Copyright Games Workshop Ltd. 1998. All rights reserved.

BLOOD BOWL

DWARF TEAM



GRIM IRONJAW
099901801



DWARF LONGBEARD 1
099900501



DWARF LONGBEARD 2
099900502



DWARF LONGBEARD 3
099900503



DWARF RUNNER 1
099900504



DWARF RUNNER 2
099900507



DWARF BLITZER 1
099900505



DWARF BLITZER 2
099900508



TROLLSLAYER 1
099900506



TROLLSLAYER 2
099900509

DWARF DEATHROLLER



DEATHROLLER SEAT
099901904



DEATHROLLER TOP
099901902



DEATHROLLER BOTTOM
099901903



DEATHROLLER SIDE
099901905

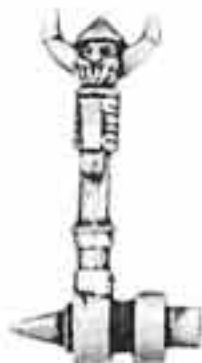

DEATHROLLER GEAR STICK
099901906



DWARF DRIVER
099901901

**A COMPLETE DWARF DEATHROLLER
CONSISTS OF:**

- 1 x DEATHROLLER SEAT
- 1 x DEATHROLLER TOP
- 1 x DEATHROLLER BOTTOM
- 1 x DEATHROLLER SIDE
- 1 x DEATHROLLER GEARSTICK
- 1 x DEATHROLLER DWARF DRIVER



DWARF DEATHROLLER



Designed by Gary Morley

BLOOD BOWL

GOBLIN TEAM



FUNGUS THE LOON
099902101



SCRAPPA SOREHEAD
099900601



BOMBER DRIBBLESNOT
099902201



NOBBLA BLACKWART
099900901



GOBLIN 1
099902501



GOBLIN 2
099902502



GOBLIN 3
099902503



GOBLIN 4
099902504



GOBLIN 5
099902505

HALFLING TEAM



HALFLING 1
099902002



HALFLING 2
099902001



HALFLING 3
099902003



HALFLING 4
099902005



HALFLING 5
099902006



HALFLING 6
099902004



BLOOD BOWL

HIGH ELF TEAM



PRINCE MORANIAN
099901701



HIGH ELF LINEMAN 1
099900101



HIGH ELF LINEMAN 2
099900102



HIGH ELF LINEMAN 3
099900103



HIGH ELF LINEMAN 4
099900104



PHOENIX WARRIOR
099900105



DRAGON WARRIOR 1
099900106



DRAGON WARRIOR 2
099900108



LION WARRIOR 1
099900109



LION WARRIOR 2
099900107



BLOOD BOWL

DARK ELF TEAM



HORKON HEARTRIPPER
099901601



DARK ELF THROWER
099900201



DARK ELF BLITZER 1
099900202



DARK ELF BLITZER 2
099900203



DARK ELF LINEMAN 3
099900208



DARK ELF LINEMAN 1
099900206



DARK ELF LINEMAN 2
099900207



WITCH ELF 1
099900204



WITCH ELF 2
099900205



Designed by Gary Morley

BLOOD BOWL

GNASHRACK BLACKHOOF



THE COMPLETE
GNASHRACK BLACKHOOF
CONSISTS OF:
1 x TORSO
1 x HEAD
1 x RIGHT ARM
1 x LEGS



HEAD
099902801



TORSO
099902802



RIGHT ARM
099902804



LEGS
099902803



WOOD ELF TEAM



WARDANCER 1
099901206



LINEMAN 1
099901201



LINEMAN 2
099901202



CATCHER 1
099901204



THROWER
099901203



CATCHER 2
099901205



WARDANCER 2
099901207



JORDELL FRESHBREEZE
73520/1



BLOOD BOWL

CHAOS TEAM



LORD BORAK THE DESPOILER
099902601



CHAOS WARRIOR 1
099901101



CHAOS WARRIOR 2
099901102



CHAOS WARRIOR 3
099901103



BEASTMAN 1
099901106



BEASTMAN 2
099901107



BEASTMAN 3
099901104



BEASTMAN 4
099901105



CHAOS MUTANT WITH CLAW &
FOUL APPEARANCE
099903101



CHAOS MUTANT WITH
TENTACLES
099903102



CHAOS MUTANT I
WITH EXTRA ARMS
099903103



Designed by Gary Morley

523

Not recommended for children under 8 years due to small parts and essential pointed components. All models supplied unpainted.
© Copyright Games Workshop Ltd 1998. All rights reserved.

BLOOD BOWL

UNDEAD TEAM



COUNT LUTHOR VON
DRAKENBURG
099901501



GHOUL 1
099901001



GHOUL 2
099901002



SKELETON 1
099901003



SKELETON 2
099901004



ZOMBIE 1
099901005



ZOMBIE 2
099901006



MUMMY 1
099901007



MUMMY 2
099901008



WIGHT 1
099901009



WIGHT 2
099901010



BLOOD BOWL

CHAOS DWARF TEAM



CHAOS DWARF BLOCKER 1
099903301



CHAOS DWARF BLOCKER 2
099903302



CHAOS DWARF BLOCKER 3
099903303



CHAOS DWARF BLOCKER 4
099903304



HOBGOBLIN 1
099903401



HOBGOBLIN 2
099903402



HOBGOBLIN 3
099903403



HOBGOBLIN 4
099903404

HTHARK THE UNSTOPPABLE



BULL CENTAUR LEFT SIDE 1
021100501



BULL CENTAUR LEFT SIDE 2
021100506



HTHARK THE UNSTOPPABLE
TORSO
099903003



BULL CENTAUR RIGHT SIDE 1
021100502



BULL CENTAUR RIGHT SIDE 2
021100505

A COMPLETE
HTHARK THE UNSTOPPABLE
CONSISTS OF:
1 x HTHARK THE UNSTOPPABLE
TORSO
1 x BULL CENTAUR LEFT SIDE
1 x BULL CENTAUR RIGHT SIDE



HTHARK THE UNSTOPPABLE



Designed by Gary Morley

525

Not recommended for children under 8 years due to small parts and essential pointed components. All models supplied unpainted.
© Copyright Games Workshop Ltd 1998. All rights reserved.

BLOOD BOWL

SKAVEN TEAM



LINEMAN 1
099900401



LINEMAN 2
099900402



LINEMAN 3
099900403



THROWER
099900406



STORM VERMIN 1
099900407



STORM VERMIN 2
099900408



GUTTER RUNNER 1
099900404



GUTTER RUNNER 2
099900405

SKAVEN MUTANTS



CLAW
099902703



EXTRA ARMS
099902702



BIG HAND
099902704



VERY LONG LEGS
099902705



HAKFLEM SKUTTLESPIKE, SKAVEN STAR PLAYER



HAKFLEM
SKUTTLESPIKE
099903201

HEADSPLITTER, RAT OGRE STAR PLAYER

THE COMPLETE
HEADSPLITTER
CONSISTS OF:
1 x HEADSPLITTER HEAD
1 x HEADSPLITTER
TORSO
1 x HEADSPLITTER LEGS



THE COMPLETED HEADSPLITTER



HEADSPLITTER HEAD
099902401



HEADSPLITTER TORSO
099902402



HEADSPLITTER LEGS
099902403

BLOOD BOWL

BLOOD BOWL CHEERLEADERS



DARK ELF CHEERLEADER
099903502



ELF CHEERLEADER
099903501



ORC CHEERLEADER
099903503



HUMAN CHEERLEADER
099903504



CHAOS CHEERLEADER
099903505



DARK ELF CHEERLEADER
099903508



GOBLIN CHEERLEADER 1
099903509



GOBLIN CHEERLEADER 2
099903510



DWARF REFEREE
099903506



HUMAN REFEREE
099903507



BLOOD BOWL

BLOOD BOWL PLASTICS

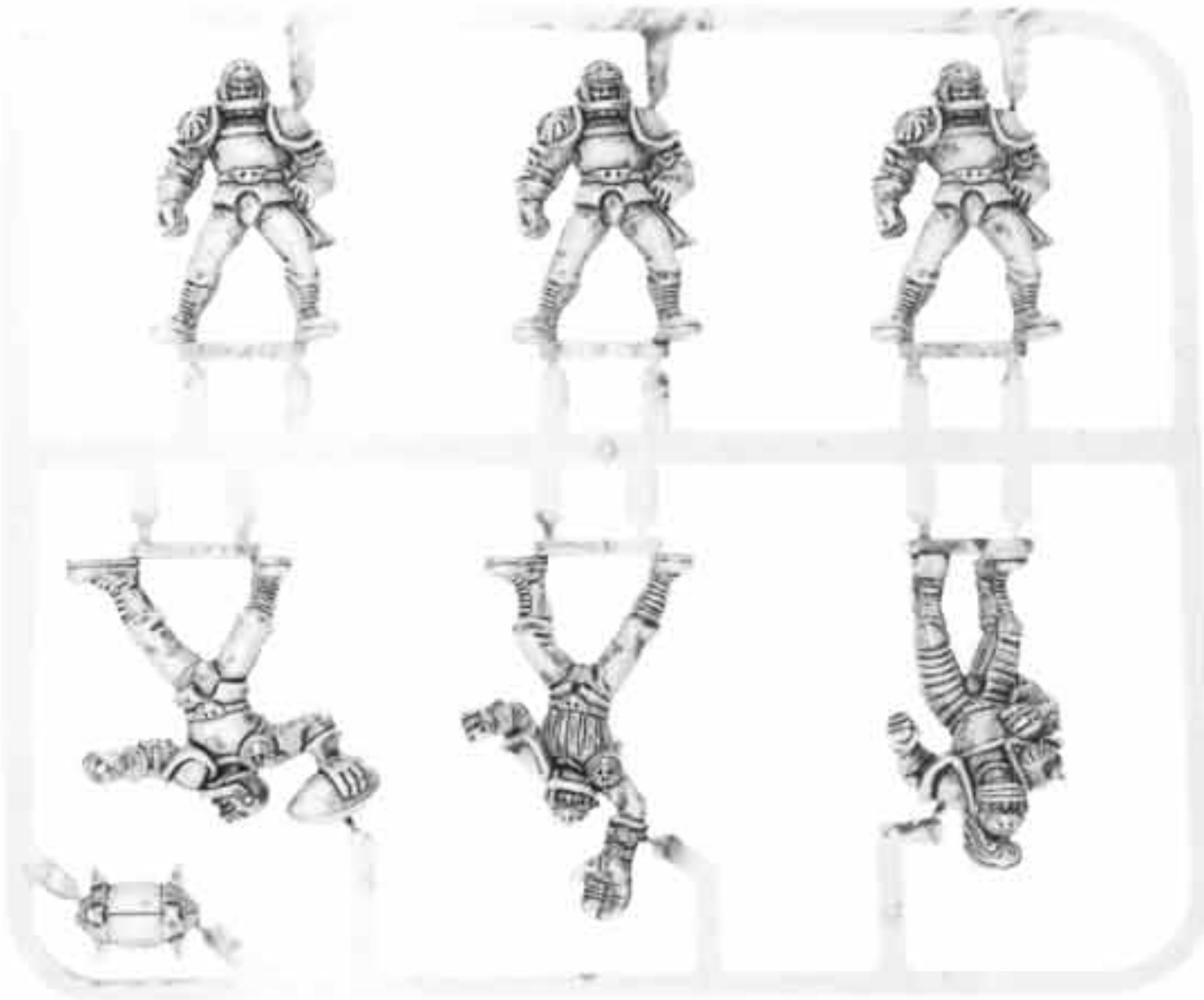

HUMAN BLOOD BOWL TEAM SPRUE
(SHOWN AT 85% ACTUAL SIZE)
99389999027

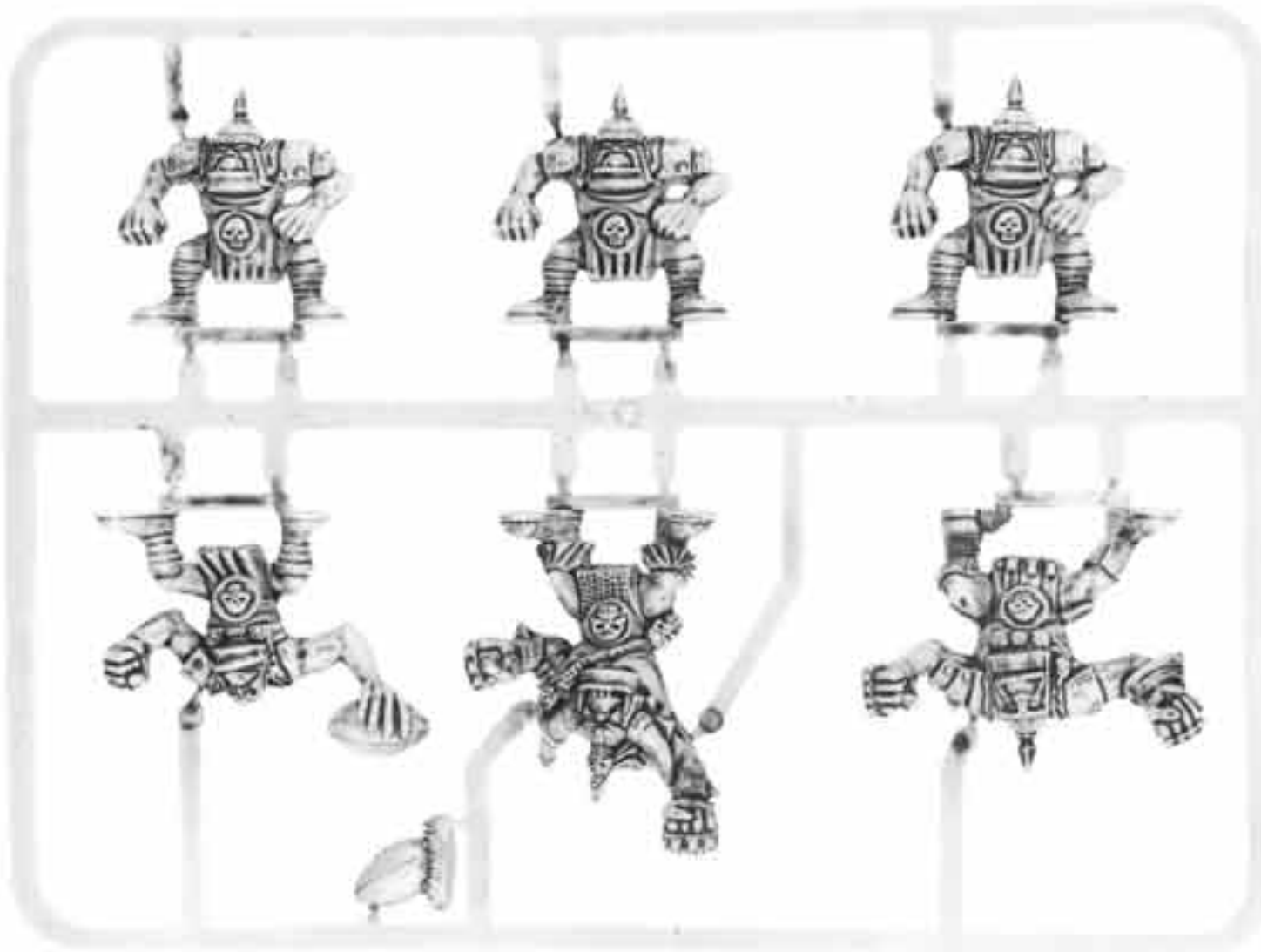

ORC BLOOD BOWL TEAM SPRUE
(SHOWN AT 85% ACTUAL SIZE)
99389999028



The Citadel Miniatures 1999 Annual is the indispensable guide to the thousands of metal and plastic Citadel models available for the current range of Games Workshop games. Packed with black and white photographs, it is an invaluable aid to all serious gamers, collectors and modellers.

DEUTSCH: Der Citadel Miniaturen-katalog 1999 ist ein unverzichtbares Nachschlagewerk zu den Tausenden von Citadel Metall- und Plastikmodellen, die es für die aktuellen Games Workshop Spiele gibt. Der mit Schwarz-Weiß-Fotographien dieser Modelle gefüllte Katalog stellt eine wichtige Hilfe für alle Spieler, Sammler und Modellbauer dar.

ESPAÑOL: El Annual 1999 de Miniaturas Citadel es la guía indispensable de las miniaturas Citadel de metal y plástico disponibles actualmente para los juegos de Games Workshop. Ilustrado con fotografías en blanco y negro de las miniaturas, este catálogo es una ayuda imprescindible para jugadores, coleccionistas y maquetistas.

ITALIANO: Il Catalogo Citadel 1999 è l'indispensabile guida alle migliaia di miniature di plastica e metallo disponibili per la gamma attuale dei giochi Games Workshop. Con le foto di tutti i modelli, questo catalogo è un inestimabile aiuto per tutti i giocatori, collezionisti e modellisti appassionati delle nostre miniature.

WARHAMMER

WARHAMMER
40,000

GORKAMORKA

WARHAMMER
EPIIC 40,000

NECROMUNDA

BLOOD BOWL

United Kingdom
Games Workshop Ltd,
Willow Road, Lenton,
Nottingham,
NG7 2WS
England

USA
Games Workshop Inc,
6721 Baymeadow Drive,
Glen Burnie, Maryland,
21060-6401
USA

Italy
Games Workshop,
Willow Road, Lenton,
Nottingham
NG7 2WS
England

Australia
Games Workshop Ltd,
23 Liverpool Street,
Ingleburn,
NSW 2565
Australia

Spain
Games Workshop SL,
Motores 300-304,
Poligono Gran Via Sur,
08908 Hospitalet De Llobregat,
Barcelona, Spain



MADE IN
THE UK



5 011921 971831

ISBN: 1 869893 66 2

Canada
Games Workshop Ltd,
1645 Bonhill Road, Units 9-11,
Mississauga,
Ontario, L5T 1R3
Canada

Hong Kong
Games Workshop,
20th Floor,
Leader Centre,
37 Wong Chuk Hang Road,
Hong Kong

Germany
Games Workshop Deutschland,
Unit 1, Glaisdale Point,
Glaisdale Industrial Estate,
Bilborough, Nottingham NG8 4GF
England

Citadel and the Citadel Castle, Games Workshop, the Games Workshop logo, Blood Bowl, Epic and Warhammer are UK registered trademarks of Games Workshop Ltd. and are trademarks of Games Workshop Ltd. in other countries around the world. Necromunda and Gorkamorka are trademarks of Games Workshop Ltd. The copyright in the contents of this package is the property of Games Workshop Ltd © 1999. All rights reserved.



CITADEL
MINIATURES

GAMES WORKSHOP