

**WHITE
DWARF**

PRESENTS



**GAMES
WORKSHOP**

CITADEL MINIATURES



1994 Catalogue



AN ULTRAMARINES CHAPLAIN LEADING A TACTICAL SQUAD OF HIS CHAPTER'S SPACE MARINES



A BLOOD BOWL MATCH BETWEEN THE CHAMPIONS OF DEATH AND THE DWARF GRUDGEBEARERS



THE FORCES OF CHAOS CONFRONT A DWARF ARMY

WHITE DWARF[®] PRESENTS

CITADEL[®] MINIATURES

1994 CATALOGUE

A compilation of catalogue pages from White Dwarf magazine

Cover art by Mark Gibbons

Black & white art by John Blanche, Wayne England, Dave Gallagher & Mark Gibbons



PRODUCED BY GAMES WORKSHOP

Games Workshop, the Games Workshop logo, Citadel, the Citadel logo, Blood Bowl, Eldar, Epic, Slannbase, Talisman, Warhammer, White Dwarf and the White Dwarf logo are all registered trademarks of Games Workshop Ltd.

Aspect Warrior, Avatar, Baneblade, Blood Angels, Carnifex, Dark Reaper, Dire Avenger, Eavy Metal, Exarch, Farseer, Fire Dragon, Gretchin, Howling Banshee, Leman Russ, Nagash, Night Goblin, Ogryn, Ork, Psyker, Shadow Sword, Skaven, Space Wolves, Squats, Storm Hammer, Swooping Hawk, Striking Scorpion, Terminator, Titan, Tyranids, Warp Spider and Weirdboy are all trademarks of Games Workshop Ltd.

All artwork in all Games Workshop products and the images contained therein have been produced either in-house or as work for hire. The exclusive copyright on the artwork and the images it depicts is the property of Games Workshop Ltd.

© Copyright Games Workshop Ltd., 1995. All rights reserved.

British Library Cataloguing-in-Publication Data. A catalogue record for this book is available from the British Library.

Game design consultant Bryan Ansell.

**A
GAMES WORKSHOP[®]
PRODUCT**

GAMES WORKSHOP LTD.
CHEWTON STREET
HILLTOP, EASTWOOD
NOTTINGHAM NG16 3HY

GAMES WORKSHOP INC.
3431-C BENSON AVENUE
BALTIMORE, MARYLAND
21227 - 1072

GAMES WORKSHOP
UNIT 7/7-9 KENT ROAD
(Cnr Church)
MASCOT NSW 2020

PRODUCT CODE: 0725

ISBN: 1 872372 89 9

CONTENTS

Welcome to the Citadel Miniatures 1994 Catalogue. This volume is a compilation of catalogue pages from White Dwarf magazine, from issue 169 up to and including issue 181. The 1994 Catalogue can be used as a reference for all the very latest and most current Citadel miniatures or as an addition to our existing range of catalogues.

BLOOD BOWL

Star Players	4
Hallings	6
Skaven Mutants	6
Grudgebearers	7
Galadrieth Gladiators	8
Chaos All-Stars	9
Skavenblight Scramblers	10
Orcland Raiders	11
Champions of death	12
Naggaroth Nightmares	13

MAN O'WAR

Flyers	15
Chaos warships	17
Empire warships	22
Chaos Dwarf warships	24
Dark Elf warships	26

WARHAMMER FANTASY BATTLE

Skaven	28
Doomwheel	28
Skaven characters	30
Clan Moulder Pack Masters	32
Gutter Runners	32
Vermin Lord	33
Skaven Screaming Bell	34
Skaven Jezzail	35
Clan Skryre	
Poisoned Wind Globadiers	35
Skaven command	36
Stormvermin	37
Plague Monks	37
Plague Censer Bearers	37
Rat Ogres	38

CHAOS

Flesh Hounds of Khorne	39
Chaos Warriors	40
Dragon Ogres	41
Chaos Knights	42
Bloodletters of Khorne	43
Daemonettes of Slaanesh	43
Chaos Warriors	43
Chaos Beastmen	44

UNDEAD

Skeleton horsemen	45
Liche King's chariot	46
Wights	48
Vampire Lord	48
Necromancer	48
Dieter Helsnicht	50
Manticore	51
Mummies	51
Zombies	52
Skeleton command	53
Undead Carrion	53
Undead Plastics	54
Zombie Dragon	56
Necromancers	57
Nagash	58
Ghoul	59
Mummies	60
Wraiths	60

ORCS & GOBLINS

Mounted Necromancer	61
Morglum Necksnapper	61
Black Orc command	63
Black Orcs	63
Savage Orc Boarboyz	64
Night Goblin Fanatics	65
Night Goblin Clubbers	65
Night Goblin Netters	65
Skarsnik and Gobbla	66
Squig Hoppers	66
Cave Squigs and Hunters	66

CHAOS DWARFS

Chaos Dwarf command	68
Chaos Dwarf axemen	68
Chaos Dwarf blunderbusses	68
Chaos Dwarf Sorcerer on Lammasu	69

HOBGOBLINS

Hobgoblin bolt thrower	71
------------------------	----

HIGH ELVES

Prince Imrik Lord of Dragons	72
Dragon Princes of Caledor	75
High Elf command group	76
High Elf warriors	76
High Elf repeater bolt thrower	77

WOOD ELVES

Wood Elf archers	78
Wood Elf Wardancers	79
Treeman	79

EMPIRE

Kislev horse archers	80
Reiksguard Knights	81
Knights of the Blazing Sun	81
Elector Counts	82
Heroes of the Empire	82
Imperial War Wagon	83
Imperial Steam Tank	84

DWARFS

Troll Slayers	85
Giant Slayers	85
Dragon Slayer	85
Daemon Slayer	85
Anvil of Doom	86
Dwarf flame cannon	87
Hammerers	88
Long Beards	88
Ironbreakers	88

EPIC

Squat Colossus	89
Iron Eagle gyrocopter	89
Goliath mega-cannon	89
Overlord airship	89
Shadow Sword	90
Baneblade	90
Stormhammer	90
Imperial Mole	90
Squat Cyclops	91
Whirlwind	92
Hellhound	92
Hydra	92
Manticore	92
Gorgon	92
Bombard	92
Deathstrike missile launcher	92
Basilisk	92
Leman Russ battle tank	93
Leviathan	93
Thunderfire cannon	93
Reaver Titans	94
Warhound Titans	95
Knight Errant	95
Knight Crusader	95
Bowel Burna	97
Squig catapult	97
Squiggoths	97
Gobsmasha	97
Spleenrippa	97
Pulsa Rokkit	97
Weirdboy Battle Tower	97
Doomdiver Magna Cannon	97

Mekboy Speedstas	97
Mekboy Gargant	99
Slasher Gargant	99
Phantom Titan	100
Eldar Nightwing	101
Tempest Grav Tank	101
Eldar Wave Serpent	101
Eldar Warp Hunter	101
Eldar Firestorm	101
Eldar Doomweaver	101
Eldar Deathstalker	101
Deathdealer	102
Doom Blaster	102
Angron	102
Bloodthirster	102
Blood Reaper	102
Tower of Skulls	102
Cauldron of Blood	102
Lungbursta	103
Giblet Grinda	103
Skullhamma	103
Brass Scorpion	103
Mortarion	103

WARHAMMER 40,000

IMPERIUM

Jump Pack Assault troops	104
Space Marines	105
Space Marine Devastators	106
Space Marines with special weapons	106
Space Marine Razorback	108
Blood Angels Death company	109
Hobgoblin Hero on Wolf	109
Space Marine Chaplains	110
Space Marine Land Speeder	112
Space Wolves Dreadnought	114
Space Wolves	
Wolf Scout Sergeants	116
Space Marine Scouts	116
Ragnar Blackmane	117
Ulrik the Slayer	117
Njal Stormcaller	117
Space Wolf Grey Hunters	117
Adeptus Arbites	118
Catachan Jungle Fighters	118
Imperial Psykers	119
Ogryns	119

ELDAR

Eldar Avatar	120
Eldrad Ulthran	120
Eldar Farseer	121
Eldar Warlocks	121
Karandas	122
Asurmen	122
Fuegan	122
Maugan Ra	123
Jain Zar	123
Baharroth	123
Eldar Shrieker jetbike	125
Eldar jetbike	125
Eldar Dreadnought	126

Eldar gun crew	127
Anti-grav weapons platform	127
Eldar War Walker	128
Eldar Wraithguard	129
Warp Spider Aspect Warriors	130
Warp Spider Exarch	130
Eldar Guardians	131
Howling Banshees	132
Swooping Hawks	132
Swooping Hawk Exarchs	132
Howling Banshee Exarch	132
Warp Spiders	133
Dire Avengers	133
Dark Reapers	134
Striking Scorpions	134
Fire Dragons	134

ORKS

Ork Bosses	136
Weirdboyz	137
Minderz	137
Goff Nobz	138
Goff Skarboyz	138
Traktor kannon	139
Gretchin assistants	140
Gretchin with autoguns	140
Gretchin with autopistols and swords	140
Pulsa Rokkit	141
Stormboyz	142
Bloodaxe Kommandos	142
Smasha Gun	143
Zodgrod Wortsnagga	144
Splatta Kannon	145
Ork Dreadnought	147
Snakebite Nobz	148
Snakebite Boarboyz Nobz	148
Snakebites	149
Snakebite Boarboyz	149

CHAOS

Nurgle Plague Marines	150
World eater Assault Marines	150
World eaters of Khorne	150

TYRANIDS

Carnifex	152
----------	-----

GAMES WORKSHOP GAMES & BOOKS

Codex Orks	153
Warhammer Chaos Dwarfs	154
Warhammer Chaos	155
Citadel Colour	156
'Eavy Metal Modelling Guide	157
Talisman	158
Dungeon of Doom	160
City of Adventure	161
Titan Legions	162
Blood Bowl	164

BOXED CITADEL MINIATURES

Chaos Warriors	166
Chaos Dwarfs	166
Chaos Knights	167
Chaos Beastmen	167
Skeleton Warriors	168
Undead Chariot	168
Skeleton Horsemen	168
Imperial Space Marines	170
Space Ork Warriors	170
Gretchin	170
Space Marines	171
Eldar Guardians	172
World eaters	173
Tyranid Warriors	174
Genestealers	174
Knight Paladins	175
Ork Bonebreakas	175
Citadel catalogues	176

IMPORTANT

Citadel miniatures and Marauder miniatures are intended for collectors, modellers and gamers.

THEY ARE NOT TOYS

Our metal models contain lead which can be harmful if ingested, but there is no real danger if you are sensible. Please follow these simple instructions:

- Please do not put them in your mouth or lick them.
- Do not buy them for or give them to small children.

Our miniatures should never be given to children under 14, nor to anyone who you cannot trust not to suck them.

Citadel miniatures are supplied unpainted and without banners. For painting your miniatures we recommend Citadel paints and brushes. Where our models require construction, we recommend you use Citadel Polystyrene Cement and Citadel Superglue.



CITADEL
MINIATURES

BLOOD BOWL

STAR PLAYERS



COUNT LUTHOR VON
DRAKENBURG
73514/1



LORD BORAK THE DESPOILER
73516/1



PRINCE MORANIAN
73511/1



VARAG GHOUL-CHEWER
73509/1



HURKON HEARTRIPPER
73515/1



THE MIGHTY ZUG
73505/1



GRIFF OBERWALD
73503/1



GRIM IRONJAW
73512/1



FUNGUS THE LOON
73506/1



SCRAPPA SOREHEAD
73502/1



BOMBER DRIBBLESNOT
73507/1



NOBBLA BLACKWORT
73501/1

BLOODBOWL

HEADSPLITTER



EXAMPLE OF COMPLETED HEADSPLITTER



TORSO
73510/2



HEADS
73510/1



LEGS
73510/3

THE COMPLETED HEADSPLITTER
CONSISTS OF:
1 x HEAD
1 x TORSO
1 x LEGS

MORG 'N' THORG



EXAMPLE OF COMPLETED MORG 'N' THORG



TORSO
73504/2



HEAD
73504/1



LEGS
73504/3

THE COMPLETED MORG 'N'
THORG CONSISTS OF:
1 x HEAD
1 x TORSO
1 x LEGS

RIPPER BOLGROT



EXAMPLE OF COMPLETED RIPPER BOLGROT

THE COMPLETE RIPPER
BOLGROT CONSISTS OF:
1 x HEAD
1 x TORSO
1 x RIGHT ARM
1 x LEGS



HEAD
73508/1



TORSO
73598/2



RIGHT ARM
73508/3



LEGS
73508/4

BLOOD BOWL

HALFLINGS



HALFLING 1
73517/2



HALFLING 2
73517/1



HALFLING 3
73517/3



HALFLING 4
73517/5



HALFLING 5
73517/6



HALFLING 6
73517/4

SKAVEN MUTANTS



EXTRA ARMS
73518/2



BIG HAND
73518/4



CLAW
73518/3



VERY LONG LEGS
73518/5

BLOOD BOWL



Models supplied unpainted.

Miniatures designed by Gary Morley

★ GRUDGEBEARERS ★

Dwarfs are ideal Blood Bowl players, being short, tough, well armoured and having the stubborn knack of refusing to give any ground to their opponents. Most successful Dwarf teams work to the principle that if they can take out all of the opposing team's potential scorers and wear down the rest, then there won't be anybody left to stop them scoring the winning touchdowns! The Grudgebearers are no exception and have become famous for their intricate and well-planned plays, as well as never forgetting an insult or dirty trick carried out by an opposing team!



TROLL SLAYER

THE GRUDGEBEARERS BOXED SET CONTAINS A COMPLETE DWARF BLOOD BOWL TEAM CONSISTING OF:

- 2 Troll Slayers
- 2 Blitzers
- 6 Long Beards
- 2 Runners

1 Grudgebearers transfer sheet to allow you to detail your team with numbers and symbols.



INCLUDES GRUDGEBEARERS' TRANSFER SHEET



WARNING! This product contains lead and may be harmful if chewed or swallowed. Citadel Miniatures are not recommended for children under 14 years of age.

Games Workshop, the Games Workshop logo, Blood Bowl, Citadel and the Citadel castle are registered trademarks of Games Workshop Ltd.

Grudgebearers is a trademark of Games Workshop Ltd. © Copyright Games Workshop Ltd, 1994. All rights reserved.



BLOOD BOWL



Models supplied unpainted.

Miniatures designed by Gary Morley

★ GALADRIETH GLADIATORS ★

When Blood Bowl was first played, the High Elves disdained the sport, however it didn't take them long to realise that there is nothing to beat seeing your team wipe out the opposition in a hard-fought game. High Elves are now renowned for their high-speed passing game, relying on the accuracy of their Phoenix Warriors and the icy calm of their catchers to score fast throwing touchdowns.



DRAGON WARRIOR

THIS BOXED SET CONTAINS A COMPLETE HIGH ELF BLOOD BOWL TEAM CONSISTING OF:

- 2 Dragon Warriors
- 2 Lion Warriors
- 1 Phoenix Warrior
- 7 Linemen
- 1 Galadrieth Gladiators transfer sheet to allow you to detail your team with numbers and symbols.

High Elf teams are also remarkable for their combination of speed and agility, which makes their players the epitome of grace when it comes to the running game.



INCLUDES GALADRIETH GLADIATORS TRANSFER SHEET



WARNING! This product contains lead and may be harmful if chewed or swallowed. Citadel Miniatures are not recommended for children under 14 years of age.

Games Workshop, the Games Workshop logo, Blood Bowl, Citadel and the Citadel castle are registered trademarks of Games Workshop Ltd.

Galadrieth Gladiators is a trademark of Games Workshop Ltd. © Copyright Games Workshop Ltd, 1994. All rights reserved.



BLOOD BOWL



Models supplied unpainted.

Miniatures designed by Gary Morley

★ CHAOS ALL-STARS ★

Chaos teams are not noted for the subtlety of their game play. A simple drive up the centre of the field, maiming and injuring as many opposing players as possible, is about the limit of their game plan.

They rarely, if ever, worry about minor considerations such as picking up the ball and scoring touchdowns – not while there are any players left alive in the opposing team, anyway!

The Chaos All-Stars boxed set contains a complete Chaos Blood Bowl team consisting of 3 Chaos Warriors and 8 Beastmen together with a Chaos All-Stars transfer sheet to allow you to add numbers and symbols to your team.



CHAOS WARRIOR



**INCLUDES
CHAOS ALL-STARS
TRANSFER
SHEET**



WARNING! This product contains lead and may be harmful if chewed or swallowed.
Citadel Miniatures are not recommended for children under 14 years of age.

Games Workshop, the Games Workshop logo, Blood Bowl, Citadel and the Citadel castle are registered trademarks of Games Workshop Ltd.

Chaos All-Stars is a trademark of Games Workshop Ltd.
© Copyright Games Workshop Ltd, 1994. All rights reserved.



BLOOD BOWL



Models supplied unpainted.

Miniatures designed by Gary Morley

★ SKAVENBLIGHT SCRAMBLERS ★

Skaven are not the toughest or strongest players to take to the Blood Bowl pitch but they are among the fastest!

Against most teams, Skaven Gutter Runners dominate the game, dashing through any gaps in their opponents' line to snatch a lightning fast touchdown.



STORM VERMIN

THIS BOXED SET CONTAINS A COMPLETE SKAVEN BLOOD BOWL TEAM CONSISTING OF:

- 2 Storm Vermin
- 3 Gutter Runners
- 1 Thrower
- 6 Linemen
- 1 Skavenblight Scramblers transfer sheet to allow you to detail your team with numbers and symbols.

As Skaven teams develop, the players' consumption of deadly Warpstone results in many grotesque, but often useful mutations that are always popular with the fans.



INCLUDES SKAVENBLIGHT SCRAMBLERS TRANSFER SHEET



WARNING! This product contains lead and may be harmful if chewed or swallowed. Citadel Miniatures are not recommended for children under 14 years of age.

Games Workshop, the Games Workshop logo, Blood Bowl, Citadel and the Citadel castle are registered trademarks of Games Workshop Ltd.

Skavenblight Scramblers is a trademark of Games Workshop Ltd. © Copyright Games Workshop Ltd. 1994. All rights reserved.

GAMES WORKSHOP

BLOOD BOWL



Miniatures supplied unpainted.

Miniatures designed by Gary Morley

★ ORCLAND RAIDERS™ ★



ORC BLITZER

Orcs have been playing Blood Bowl since the game began. They just love the mayhem and treat every game as an excuse for a good brawl.

This approach has also made them very successful. The Orcland Raiders were the first-ever winners of the Blood Bowl Open Championship, and this famous team is rightly feared across the Old World for its ferocity and power.

Their aggressive and violent approach to the game has often been mimicked but rarely bettered, and the team are sure-fire candidates to walk away with the coveted Blood Bowl Open Championship trophy for a second time.

THIS BOXED SET CONTAINS THE COMPLETE ORCLAND RAIDERS BLOOD BOWL TEAM CONSISTING OF:

- 1 Orc Thrower
- 2 Black Orc Blockers
- 3 Orc Blitzers
- 5 Orc Linemen
- 1 Orcland Raiders transfer sheet to allow you to detail your team with numbers and symbols.



INCLUDES ORCLAND RAIDERS TRANSFER SHEET

WARNING! This product contains lead and may be harmful if chewed or swallowed. Citadel Miniatures are not recommended for children under 14 years of age.

Games Workshop, the Games Workshop logo, Blood Bowl, Citadel and the Citadel castle are registered trademarks of Games Workshop Ltd

Orcland Raiders is a trademark of Games Workshop Ltd. © Copyright Games Workshop Ltd, 1994. All rights reserved.



BLOOD BOWL



Models supplied unpainted.

Miniatures designed by Gary Morley

★ CHAMPIONS OF DEATH ★



BLOOD BOWL WIGHT

Blood Bowl fans both love and fear Undead teams. Although they have a tendency to fall to pieces in the middle of the scrimmage, they are renowned for their ability to make a come back!

Their opponents often stand aghast as Skeletons and Zombies rise from fatal blows and return to the fray with renewed vigour. Many Blood Bowl teams have even found themselves playing against a formerly deceased team mate or Star Player who has been returned to undeath!

THIS BOXED SET CONTAINS THE COMPLETE CHAMPIONS OF DEATH BLOOD BOWL TEAM CONSISTING OF:

- 2 Mummies 2 Ghouls
- 2 Wights 3 Zombies
- 3 Skeletons

1 Champions of Death transfer sheet to allow you to detail your team with numbers and symbols.



INCLUDES CHAMPIONS OF DEATH™ TRANSFER SHEET



WARNING! This product contains lead and may be harmful if chewed or swallowed. Citadel Miniatures are not recommended for children under 14 years of age.

Games Workshop, the Games Workshop logo, Blood Bowl, Citadel and the Citadel castle are registered trademarks of Games Workshop Ltd.

Champions of Death is a trademark of Games Workshop Ltd. © Copyright Games Workshop Ltd, 1994. All rights reserved.



BLOOD BOWL



★ NAGGAROTH NIGHTMARES™ ★



WITCH ELF

Dark Elves make superb Blood Bowl players, combining their strength, speed and agility with a low cunning and an evil temperament.

Although best suited to the throwing game, sheer spite makes the Dark Elves enjoy the violent conflict of the running game. Witch Elves and Dark Elf Blitzers in particular, excel at punching a hole in the opposing line of scrimmage through which their fleet-footed team mates can run.

THIS BOXED SET CONTAINS THE COMPLETE NAGGAROTH NIGHTMARES BLOOD BOWL TEAM CONSISTING OF:

- 1 Dark Elf Thrower
- 2 Witch Elves
- 2 Dark Elf Blitzers
- 7 Dark Elf Linemen
- 1 Naggaroth Nightmares transfer sheet to allow you to detail your team with numbers and symbols.



INCLUDES NAGGAROTH NIGHTMARES™ TRANSFER SHEET

WARNING! This product contains lead and may be harmful if chewed or swallowed. Citadel Miniatures are not recommended for children under 14 years of age.

Games Workshop, the Games Workshop logo, Blood Bowl, Citadel and the Citadel castle are registered trademarks of Games Workshop Ltd

Naggaroth Nightmares is a trademark of Games Workshop Ltd. © Copyright Games Workshop Ltd, 1994. All rights reserved.

GAMES WORKSHOP



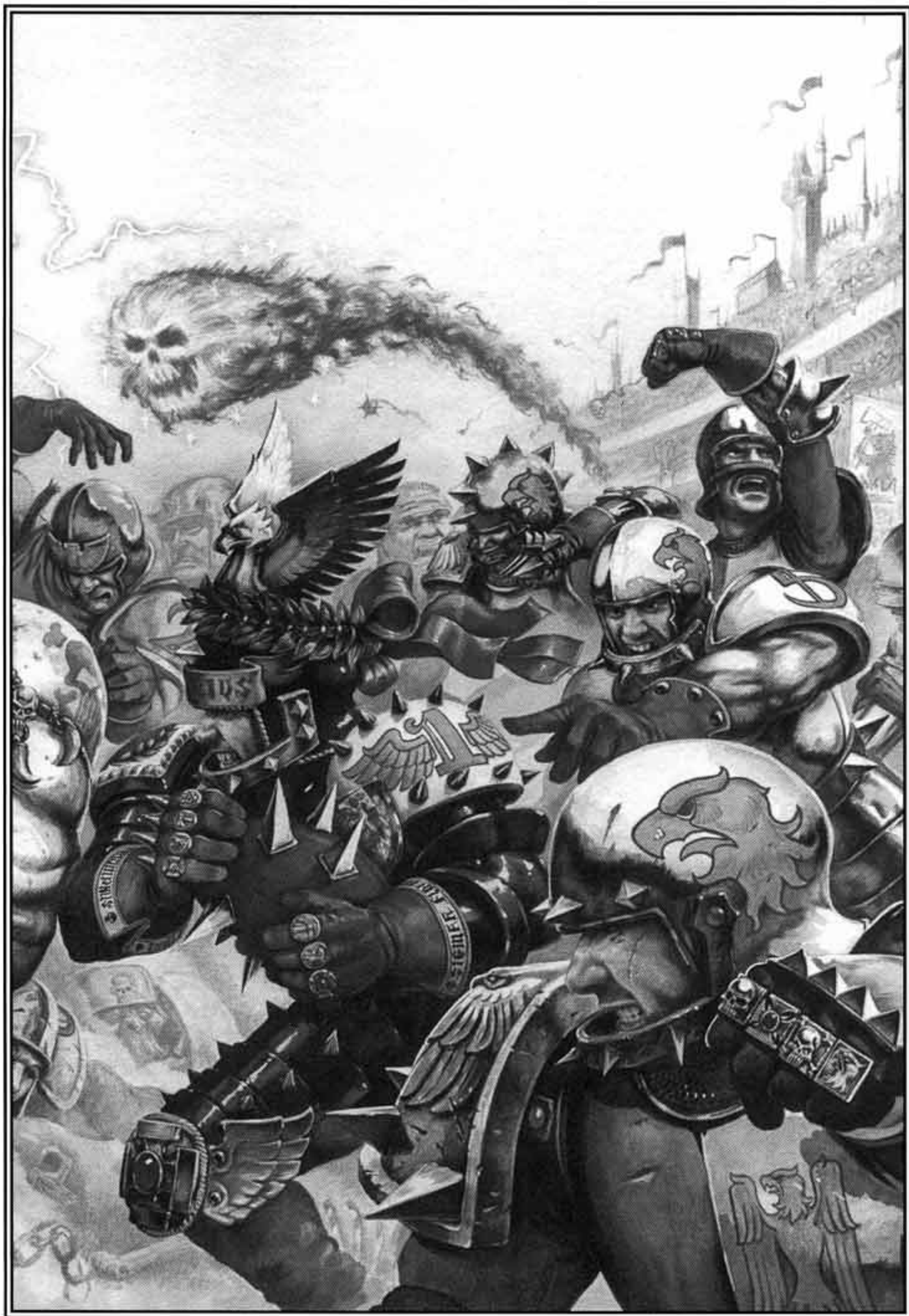

MAN O' WAR

IMPERIAL GRIFFON RIDER



GRIFFON BODY
78066/2



WINGS 1
78004/1

THE COMPLETE
IMPERIAL GRIFFON RIDER
CONSISTS OF:
1 x GRIFFON BODY
1 x WINGS 1

ORC WYVERN RIDER



WYVERN BODY
78034/2



WINGS 2
78005/1

THE COMPLETE
ORC WYVERN RIDER
CONSISTS OF:
1 x WYVERN BODY
1 x WINGS 2

HIGH ELF EAGLE RIDER



EAGLE BODY
78004/2



WINGS 1
78004/1

THE COMPLETE
HIGH ELF EAGLE RIDER
CONSISTS OF:
1 x EAGLE BODY
1 x WINGS 1

HIGH ELF DRAGON RIDER



DRAGON BODY
78005/2



WINGS 2
78005/1

THE COMPLETE
HIGH ELF DRAGON RIDER
CONSISTS OF:
1 x DRAGON BODY
1 x WINGS 2

DWARF GYROCOPTER



GYROCOPTER WINGS
78063/2



GYROCOPTER BODY
78063/1

THE COMPLETE
DWARF GYROCOPTER
CONSISTS OF:
1 x GYROCOPTER BODY
1 x GYROCOPTER WINGS

DWARF WAR BALLOON



BALLOON
78065/1



GONDOLA
78065/2

THE COMPLETE
DWARF WAR BALLOON
CONSISTS OF:
1 x BALLOON
1 x ARMoured GONDOLA

© Copyright Games Workshop Ltd 1993. All rights reserved. Miniatures supplied unpainted. This product contains lead which may be harmful if swallowed. Critical Miniatures are not recommended for children under 14 years of age.



MAN O'WAR

BRETONNIAN PEGASUS RIDER



PEGASUS BODY
78014/2



WINGS 1
78004/1

THE COMPLETE BRETONNIAN PEGASUS RIDER CONSISTS OF:
1 x PEGASUS BODY
1 x WINGS 1



DARK ELF MANTICORE RIDER



MANTICORE BODY
78024/2



WINGS 2
78005/1

THE COMPLETE DARK ELF MANTICORE RIDER CONSISTS OF:
1 x MANTICORE BODY
1 x WINGS 2



Designed by Michael Perry

SEA OF BLOOD



SEA OF BLOOD IS THE SECOND SUPPLEMENT TO THE MAN O'WAR GAME OF RAGING SEA BATTLES.

Sea of Blood contains new rules for sea monsters and flying creatures, to be used in conjunction with the Man O'War game and the Plague Fleet supplement:

Sea Monsters

The Triton, Sea Elemental, Sea Dragon, Megaladon, Promethean, Black Leviathan, Gargantuan and Behemoth rise to the surface to vent their fury against the fleets of the Known World.

Airpower

Bretonnian Pegasus Riders, Dwarf Gyrocopters and War Balloons, Elf Dragon Riders and War Eagles, Imperial Griffon Riders, Orc Wyvern Riders, Dark Elf Manticore Lords, Chaos Dwarf Taurus Riders and Lords of Change fill the smoke-laden skies above the battle.

MAN O'WAR™
SUPPLEMENT

SEA OF BLOOD IS NOT A COMPLETE GAME. YOU WILL NEED A COPY OF THE MAN O'WAR GAME TO USE THE CONTENTS OF THIS BOX

GAMES®
WORKSHOP

CHAOS WARSHIPS

PLAGUE CRUSHER

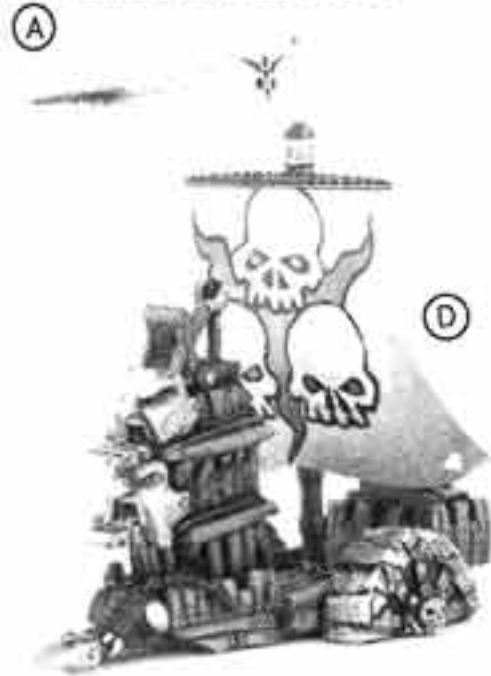

CATAPULT TOWER
8042/2

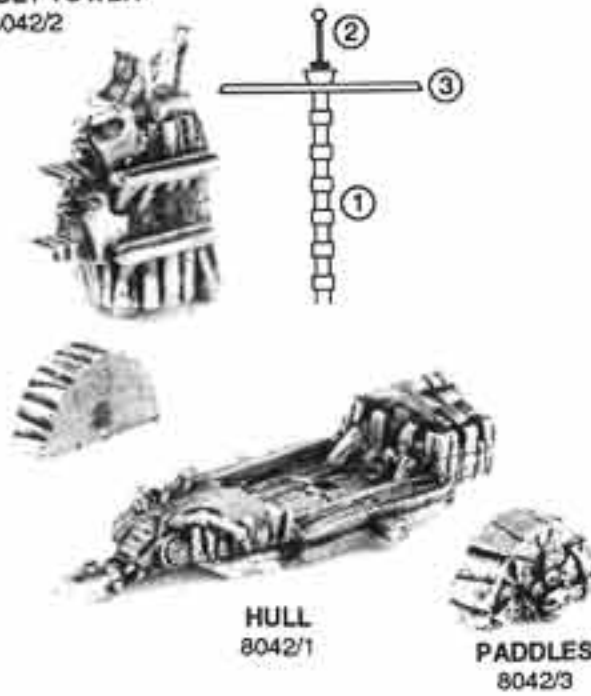

THE COMPLETE
NURGLE PLAGUE CRUSHER
CONSISTS OF:
1 x HULL
1 x CATAPULT TOWER
2 x PADDLES

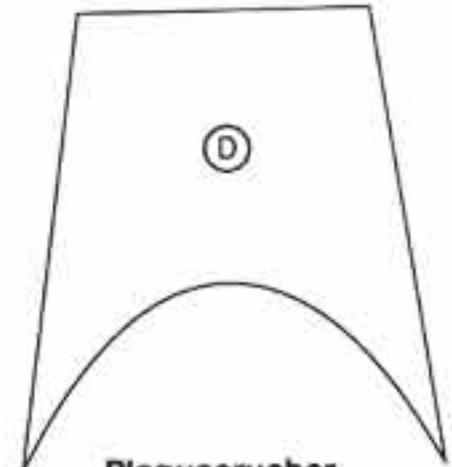

Plaguecrusher
Masts: one 1, one 2
Yard: one 3

PLAGUE SHIP

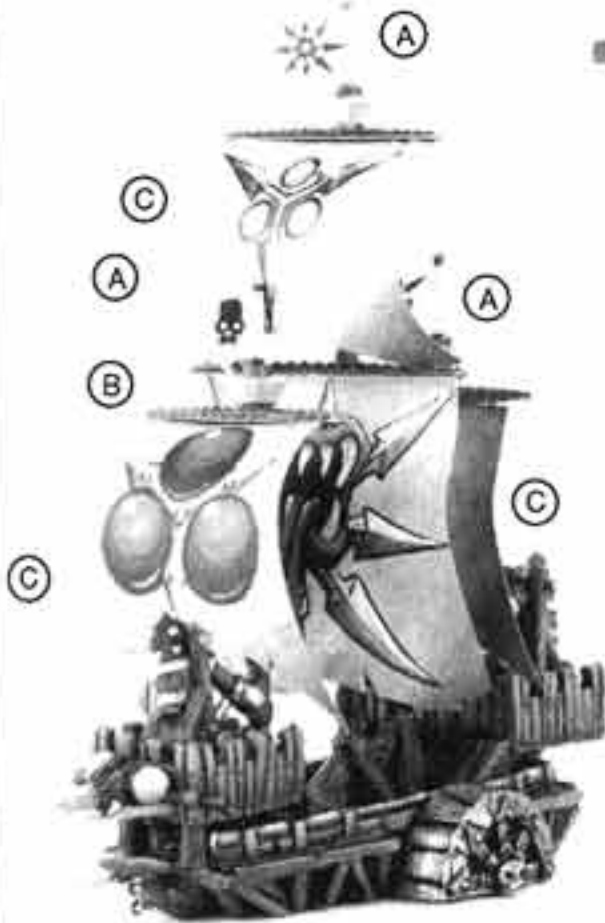

HULL
8041/1

THE COMPLETE
NURGLE PLAGUE SHIP
CONSISTS OF:
1 x HULL
1 x ART CASTLE
1 x FORECASTLE
2 x PADDLES
3 x PLAGUE CATAPULT

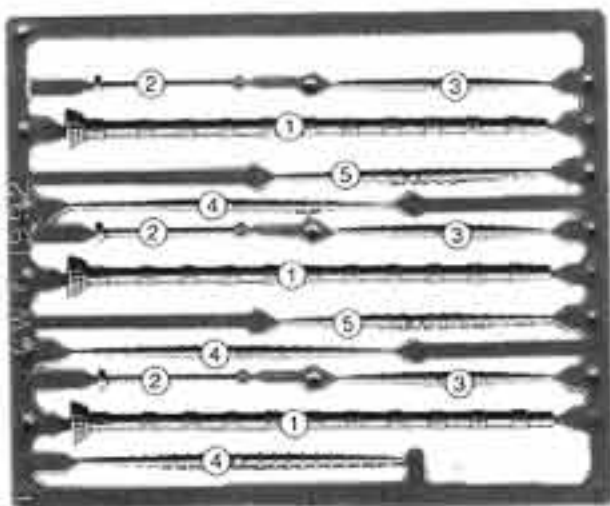
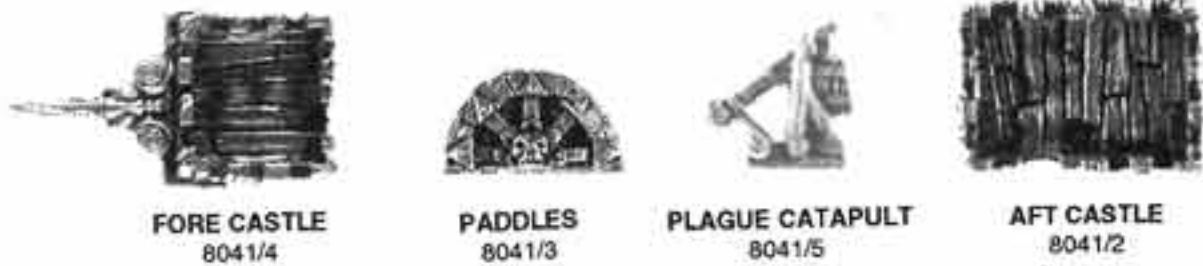

MAN O' WAR PLASTIC
MAST SPRUE
MOWPLA/2

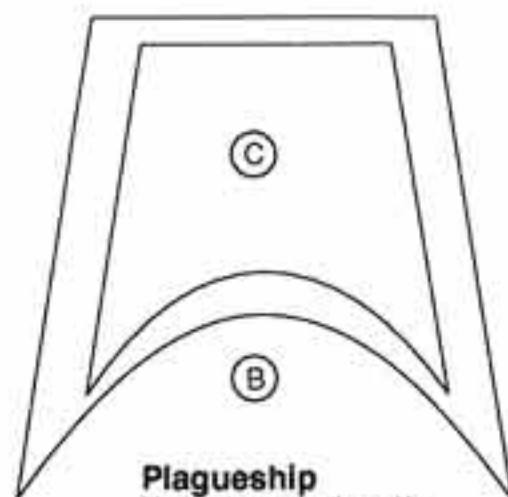

Plagueship
Masts: three 1's, three 2's
Yard: three 3's, one 5

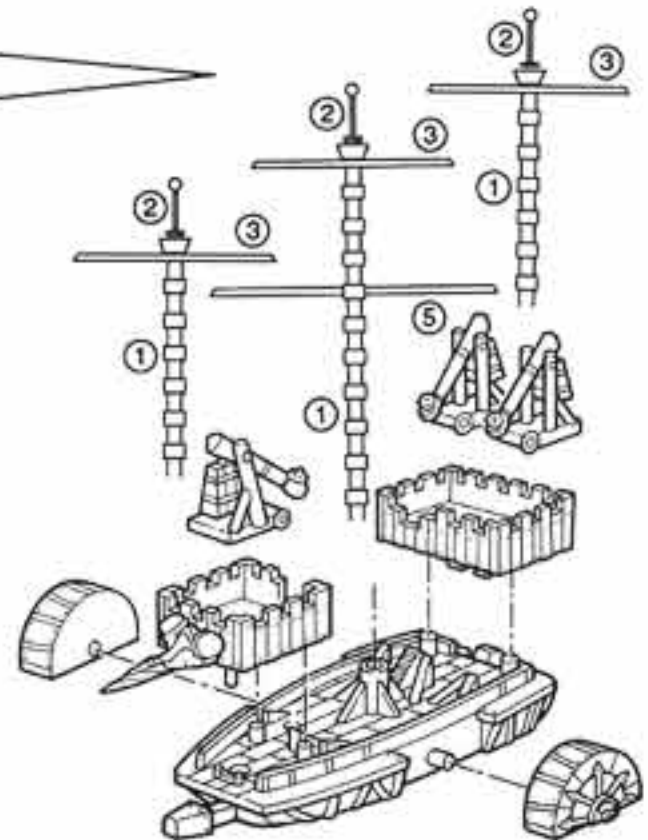

THE DIAGRAM ABOVE ILLUSTRATES THE CORRECT LENGTH FOR EACH MAST AND THE TYPE AND NUMBER OF YARD ARMS.

THE SAILS AND PENNANTS ABOVE MAY BE PHOTOCOPIED, CUT OUT, PAINTED AND STUCK ONTO YOUR MINIATURES.

PERMISSION GRANTED TO PHOTOCOPY FOR PERSONAL USE ONLY.

CHAOS WARSHIPS

SLAANESH HELLSHIP

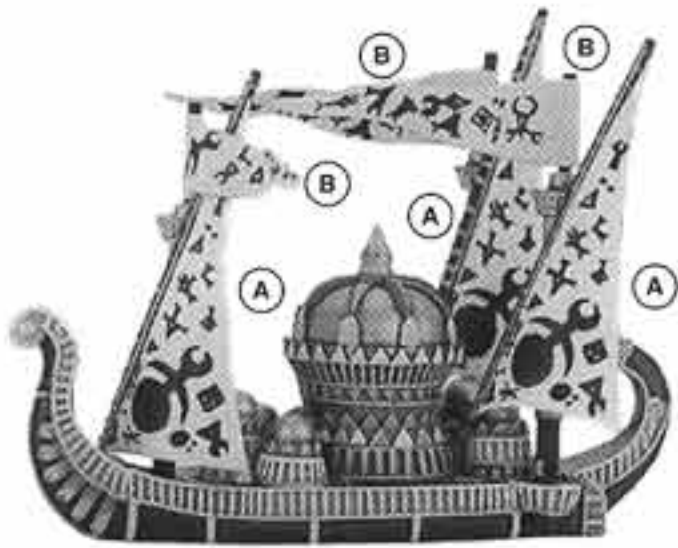

EXAMPLE OF COMPLETED AND PAINTED HELLSHIP

THE COMPLETE HELLSHIP
CONSISTS OF:

- 1 x HELLSHIP HULL
- 1 x HELLSHIP PROW
- 1 x HELLSHIP STERN
- 1 x HELLSHIP DOME
- 1 x PLASTIC MAST SPRUE

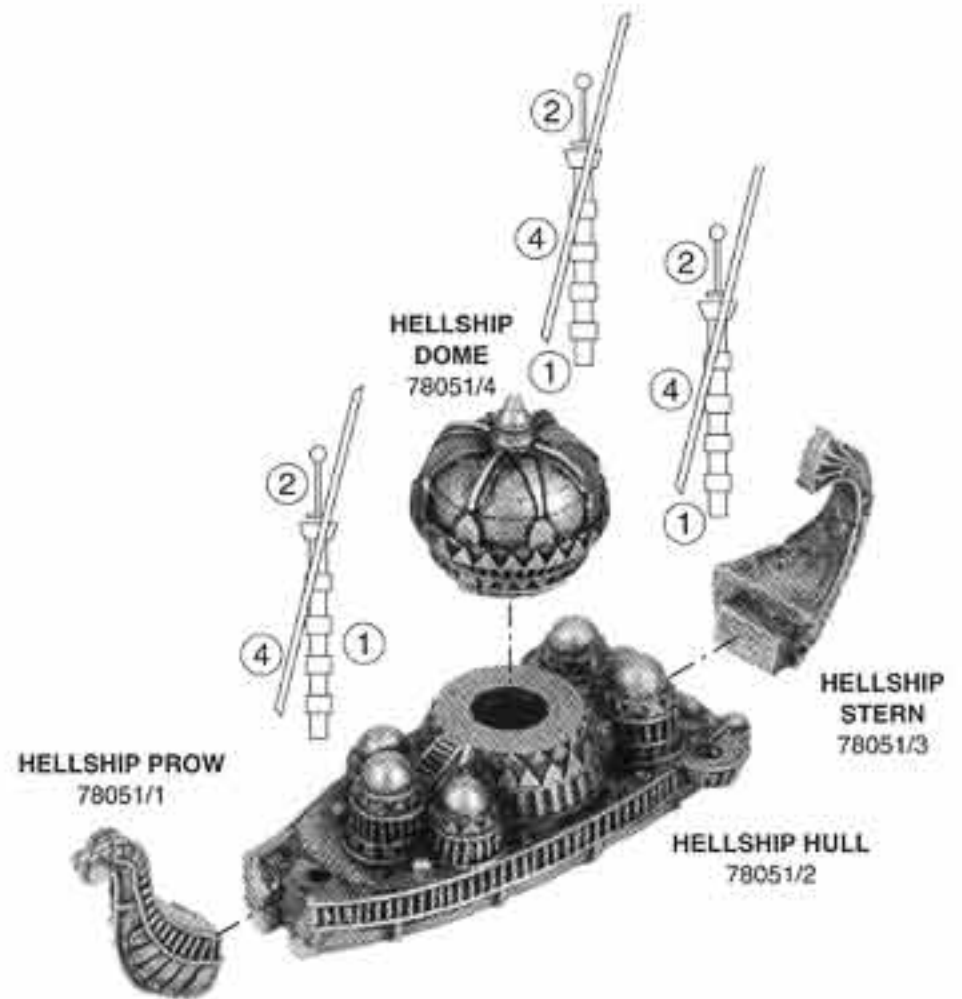
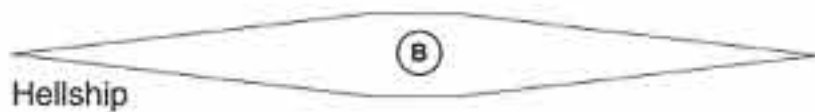
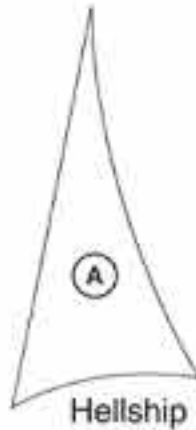

SLAANESH HELLRAMMER

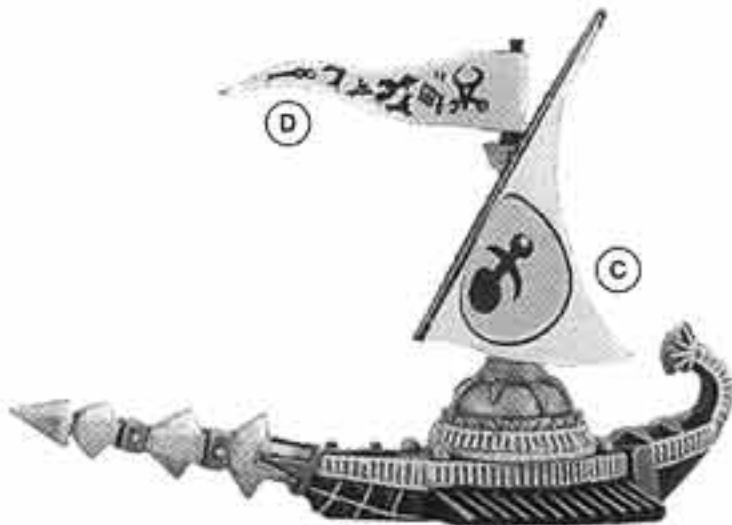

EXAMPLE OF COMPLETED AND PAINTED HELLRAMMER

THE COMPLETE HELLRAMMER
CONSISTS OF:

- 1 x HELLRAMMER HULL
- 1 x HELLRAMMER FORE & AFT SECTION
- 1 x HELLRAMMER DOME
- 1 x PLASTIC MAST SPRUE

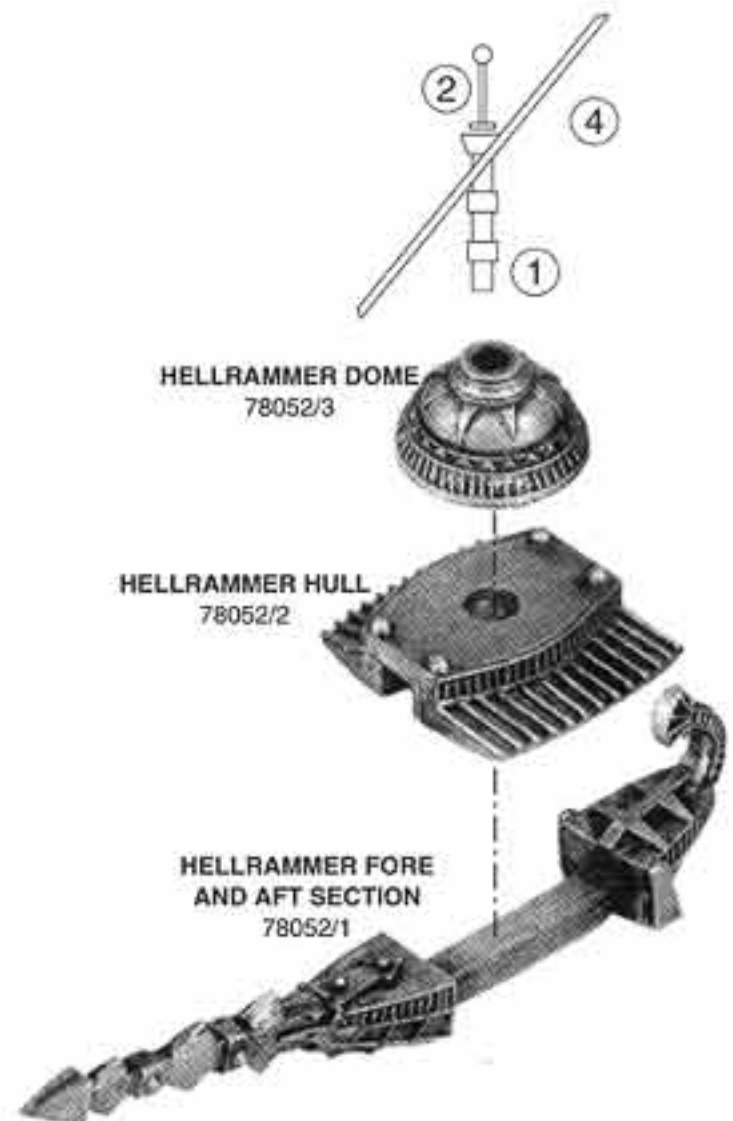
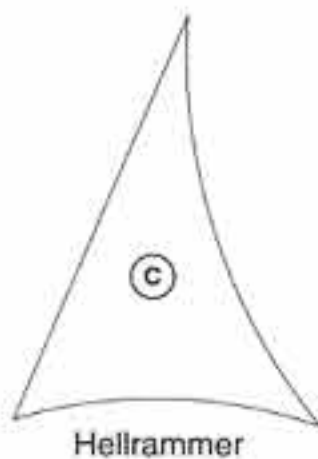

CHAOS WARSHIPS

BLOODSHIP OF KHORNE

THESE MINIATURES ARE SUPPLIED WITH A PLASTIC MAST SPRUE AS STANDARD

THE COMPLETED BLOODSHIP OF KHORNE CONSISTS OF:
 1 x BLOODSHIP HULL
 1 x BLOODSHIP CLAWS
 1 x BLOODSHIP AFT
 2 x BLOODSHIP CANNON

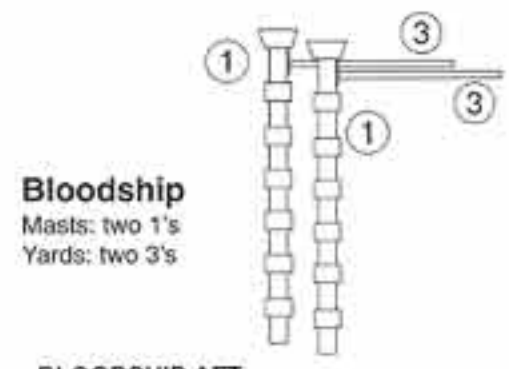
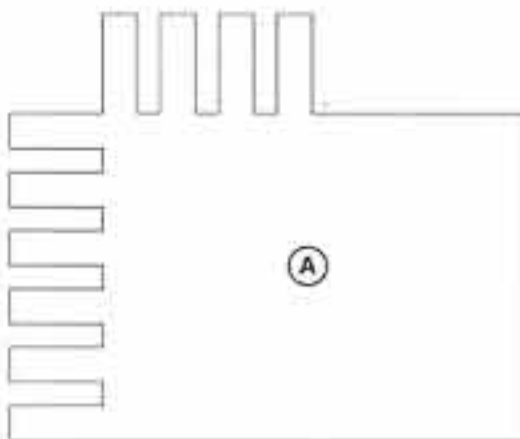

Bloodship
 Masts: two 1's
 Yards: two 3's

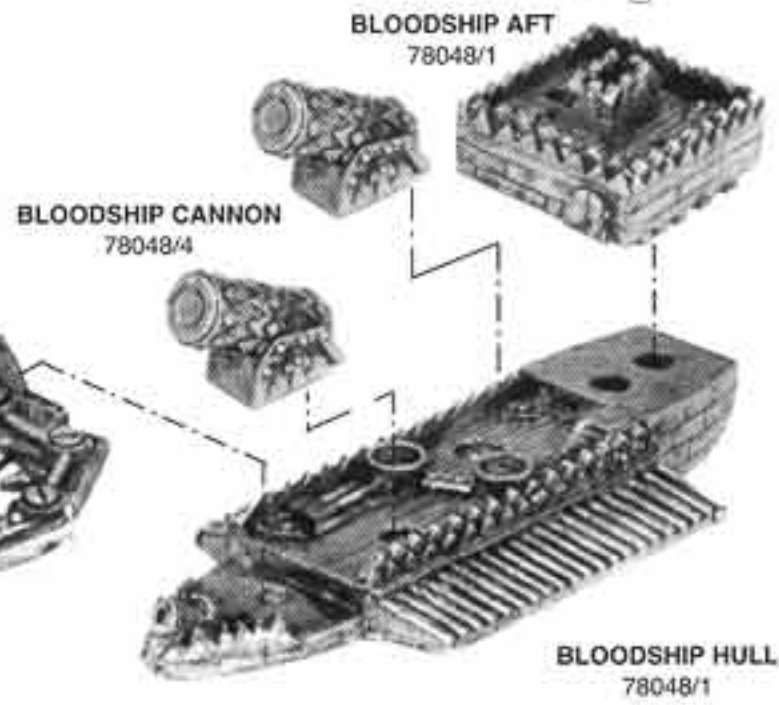

IRONSHARK OF KHORNE

THE COMPLETED IRONSHARK OF KHORNE CONSISTS OF:
 1 x IRONSHARK HULL
 1 x IRONSHARK HEAD

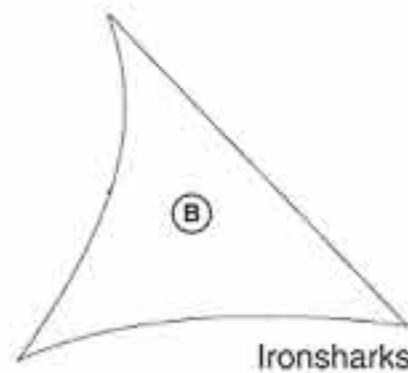

Ironshark
 Masts: one 1, one 2
 Yard: one 5

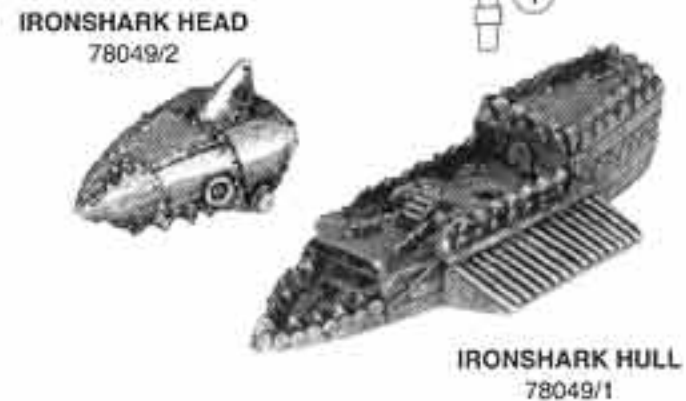
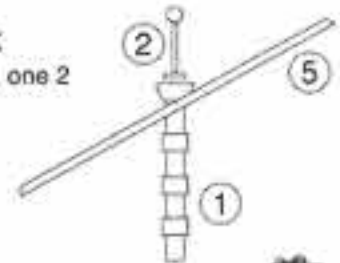

DEATHGALLEY

Deathgalley
 Masts: one 1, one 2
 Yard: one 3

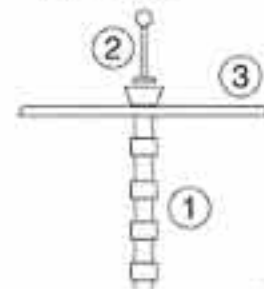
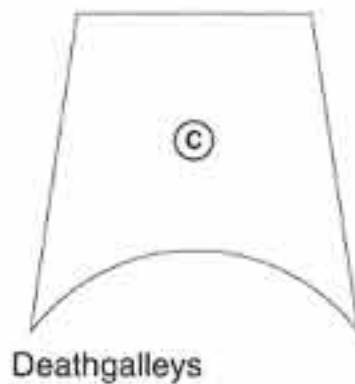
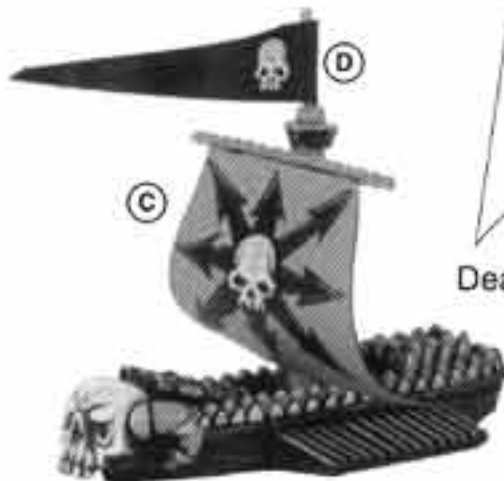

Deathgalley and Ironshark

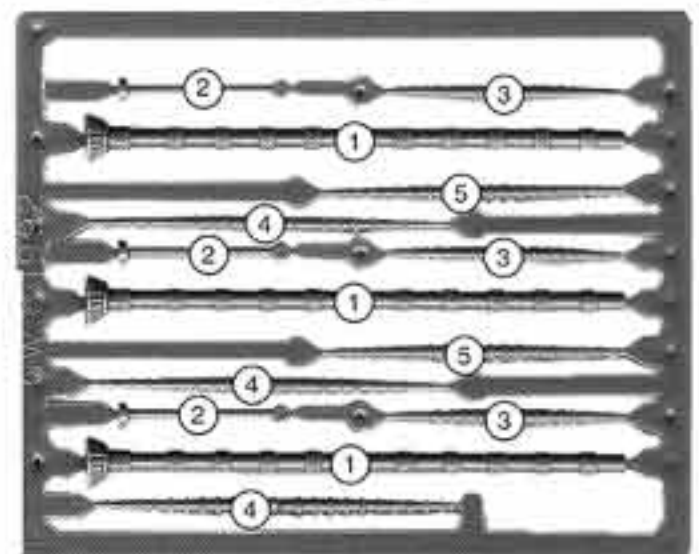
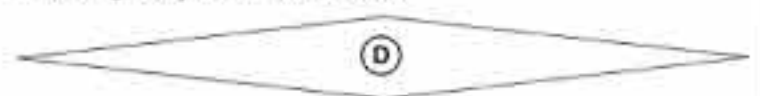

PLASTIC MAST SPRUE MOW PLA/2



CHAOS WARSHIPS

SLAANESH HELLSLICER

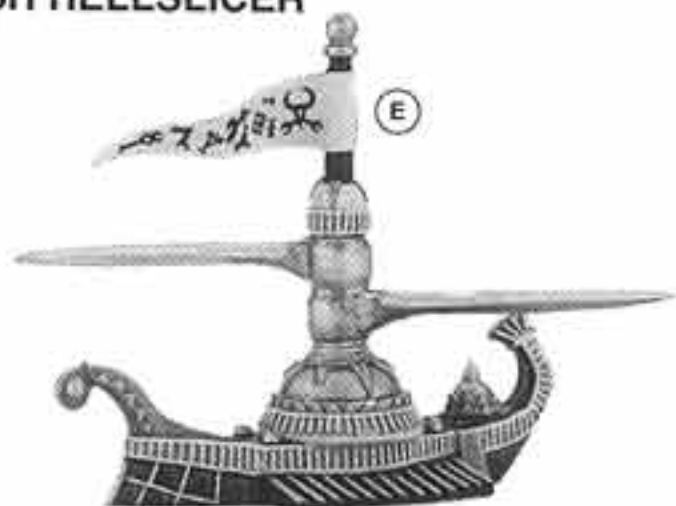

EXAMPLE OF COMPLETED AND PAINTED HELLSLICER

- THE COMPLETE HELLSLICER CONSISTS OF:**
- 1 x HELLSLICER HULL
 - 1 x HELLSLICER FORE & AFT SECTION
 - 1 x HELLSLICER DOME
 - 1 x HELLSLICER TOP BLADE
 - 1 x HELLSLICER BOTTOM BLADE
 - 1 x PLASTIC MAST SPRUE

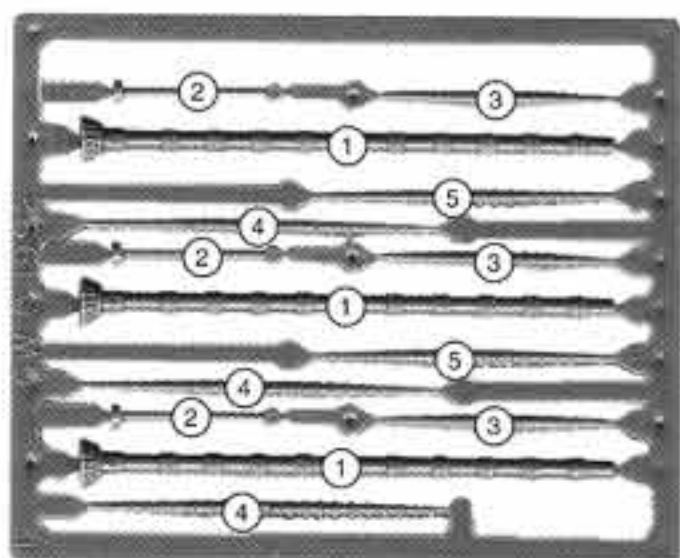

PLASTIC MAST SPRUE MOW PLA/2

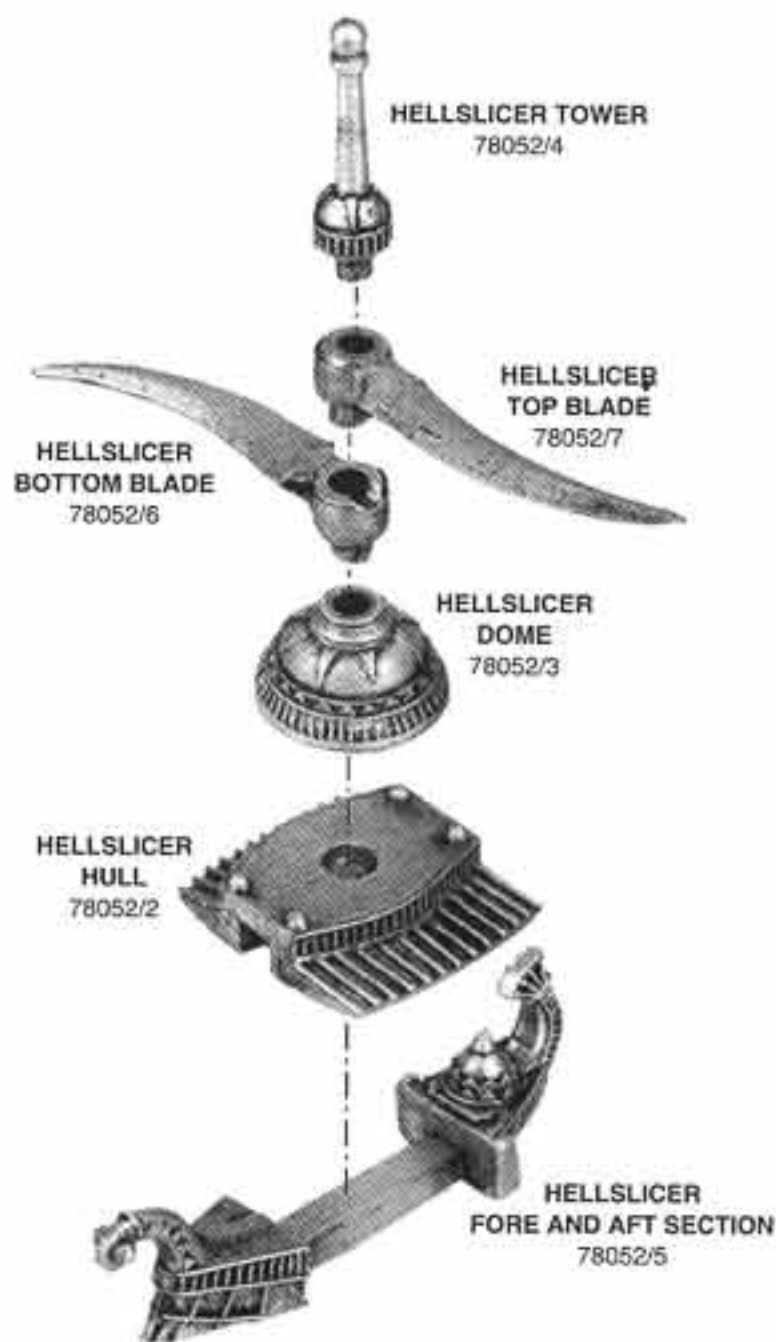

Hellslicer

Designed by Norman Swales

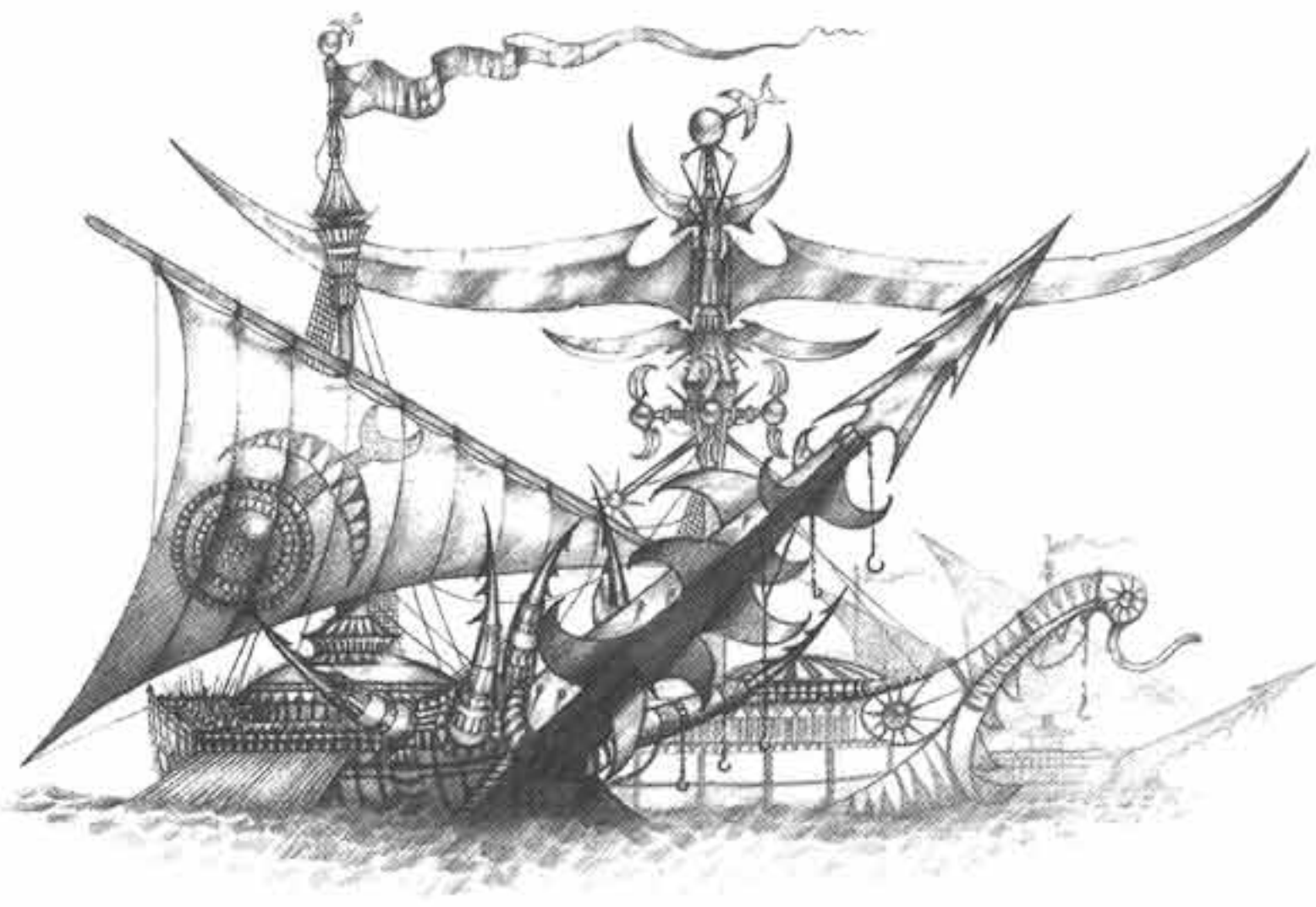

EMPIRE WARSHIPS

IMPERIAL GREATSHIP

AN IMPERIAL GREATSHIP CONSISTS OF:

- 1 x HULL
- 1 x AFT CASTLE
- 1 x FORE CASTLE

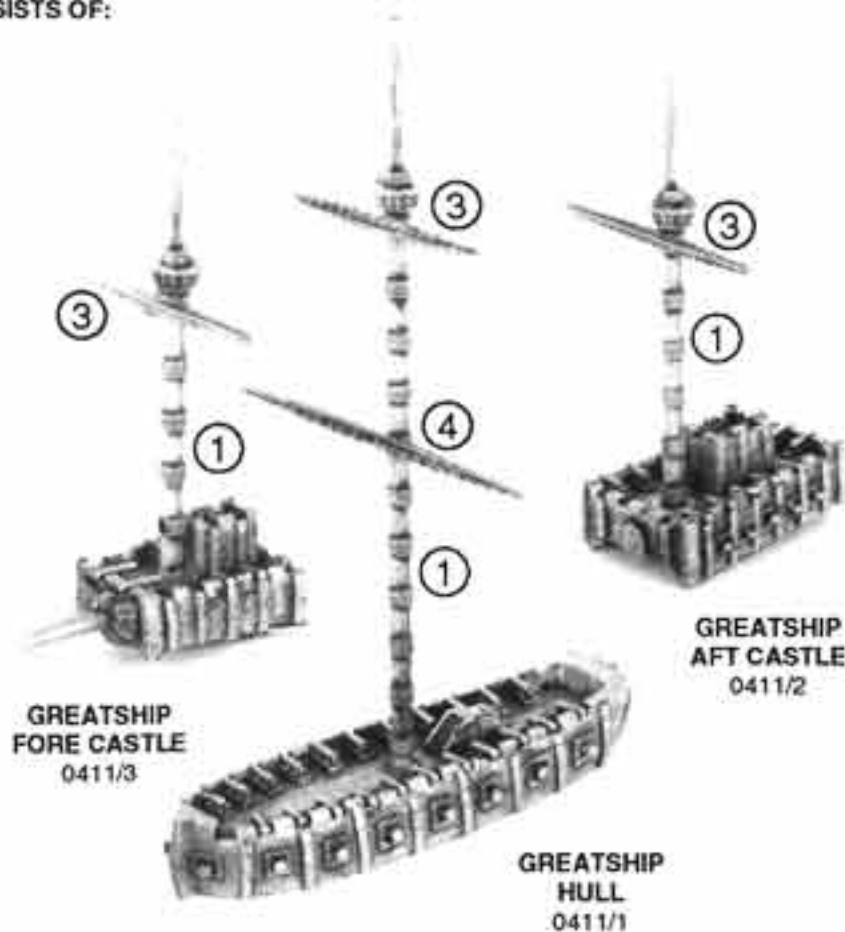
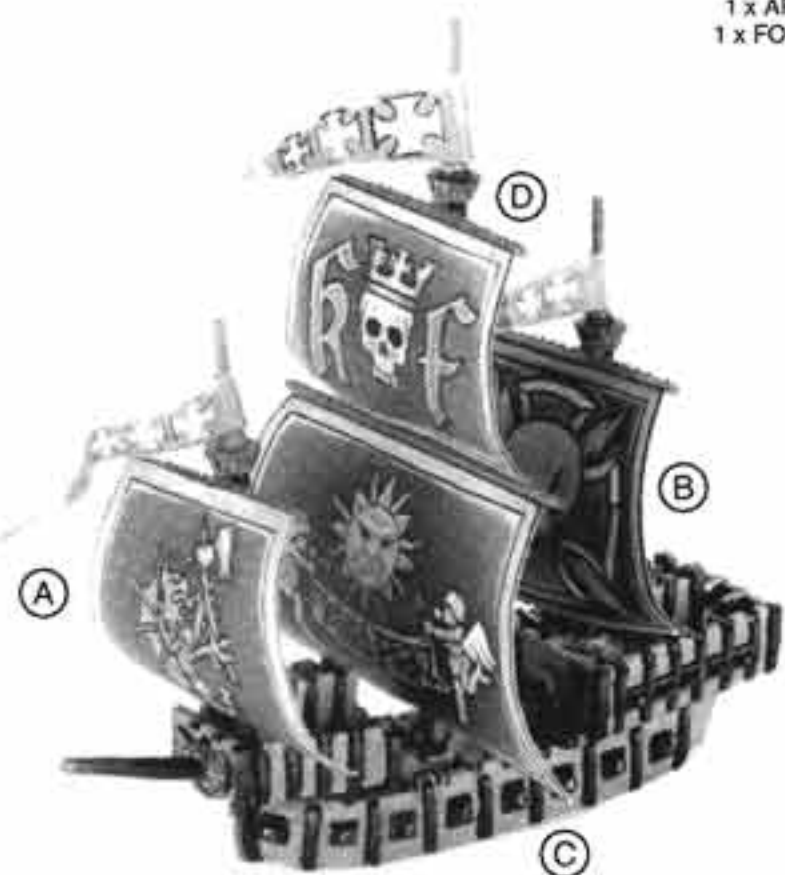

EXAMPLE OF COMPLETED AND FULLY PAINTED GREATSHIP

NOTE THAT SOME OF THESE SHIPS' MASTS HAVE BEEN SHORTENED TO MAKE THEM THE CORRECT LENGTH FOR EACH TYPE OF SHIP; REFER TO THE MAN O' WAR PAINTING GUIDE FOR MORE DETAILS ON HOW TO DO THIS.

IMPERIAL WOLFSHIP

AN IMPERIAL WOLFSHIP CONSISTS OF:

- 1 x HULL
- 1 x AFT CASTLE

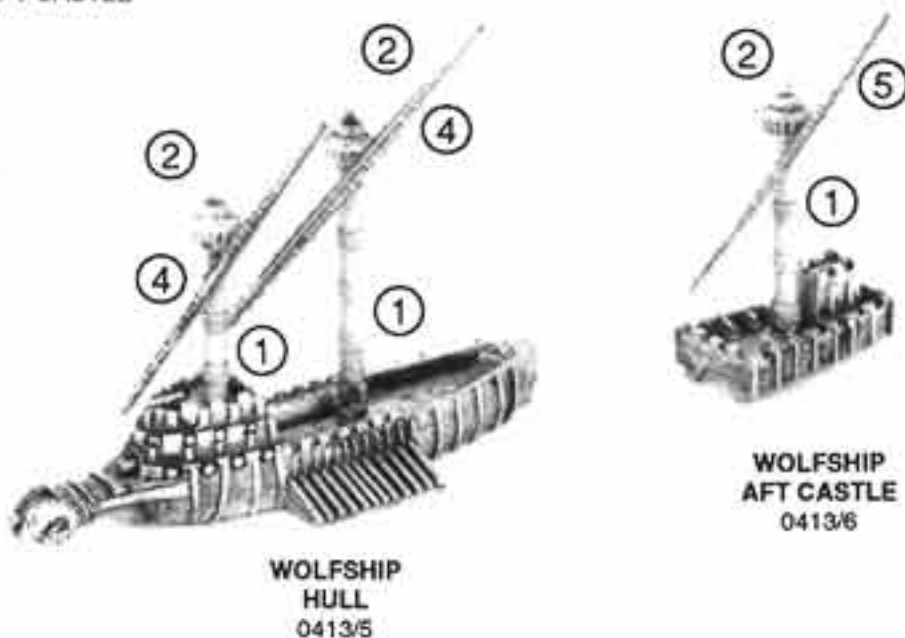
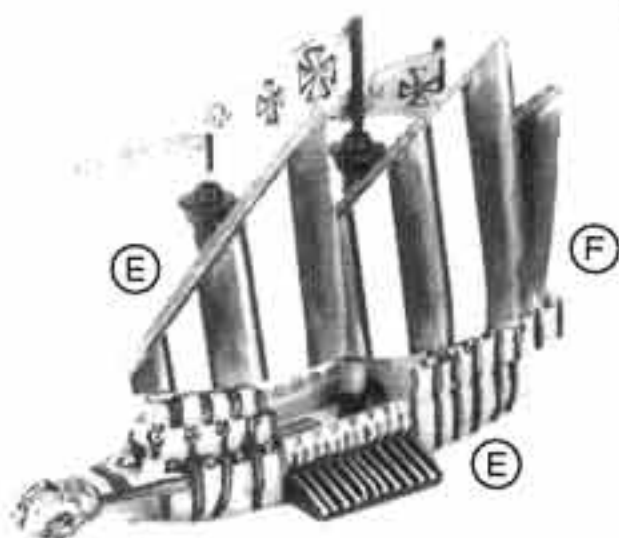

EXAMPLE OF COMPLETED AND FULLY PAINTED WOLFSHIP

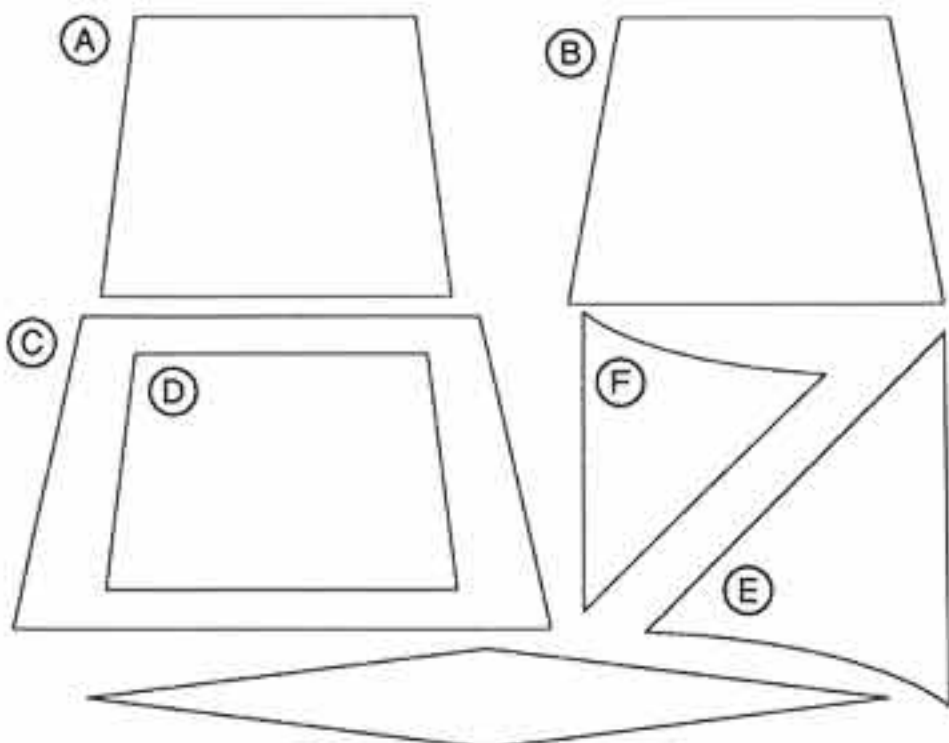

THESE SAILS AND PENNANTS MAY BE PHOTOCOPIED, CUT OUT, PAINTED AND STUCK ONTO YOUR MINIATURES. PERMISSION GRANTED TO PHOTOCOPY FOR PERSONAL USE ONLY.

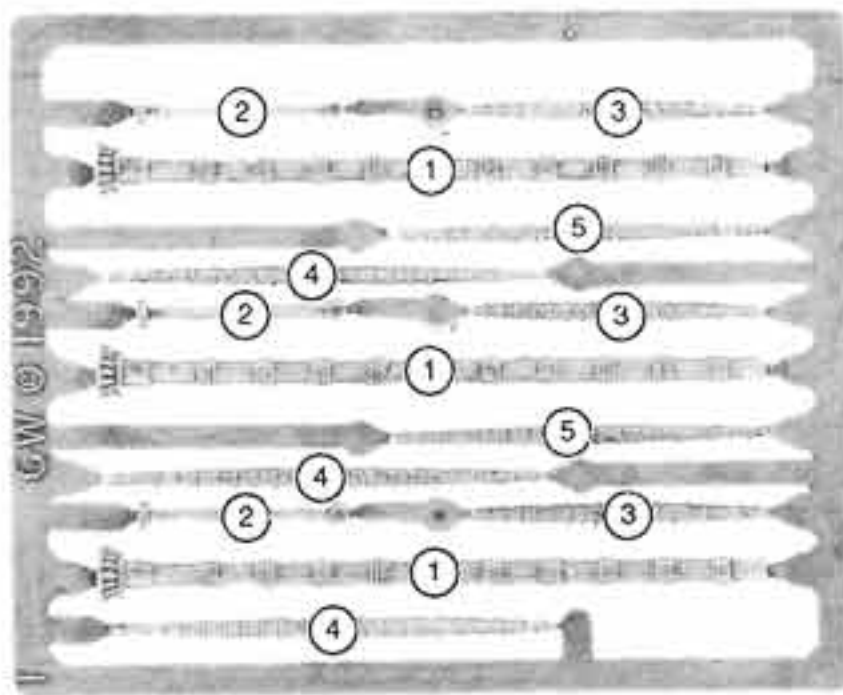

MAN O' WAR PLASTIC MAST SPRUE
MOWPLA2

THESE MODELS ARE SUPPLIED WITH ONE OR MORE MAST SPRUES WHERE NECESSARY.

© Copyright Games Workshop Ltd 1994. All rights reserved.



EMPIRE WARSHIPS

IMPERIAL WARGALLEY



IMPERIAL
WARGALLEY
0412/7

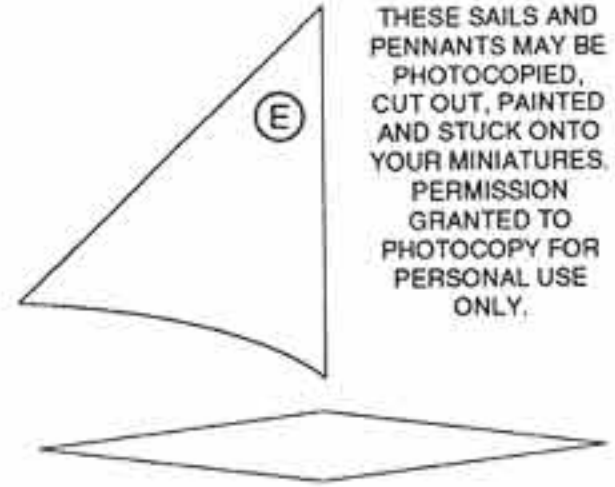

THESE SAILS AND
PENNANTS MAY BE
PHOTOCOPIED,
CUT OUT, PAINTED
AND STUCK ONTO
YOUR MINIATURES.
PERMISSION
GRANTED TO
PHOTOCOPY FOR
PERSONAL USE
ONLY.

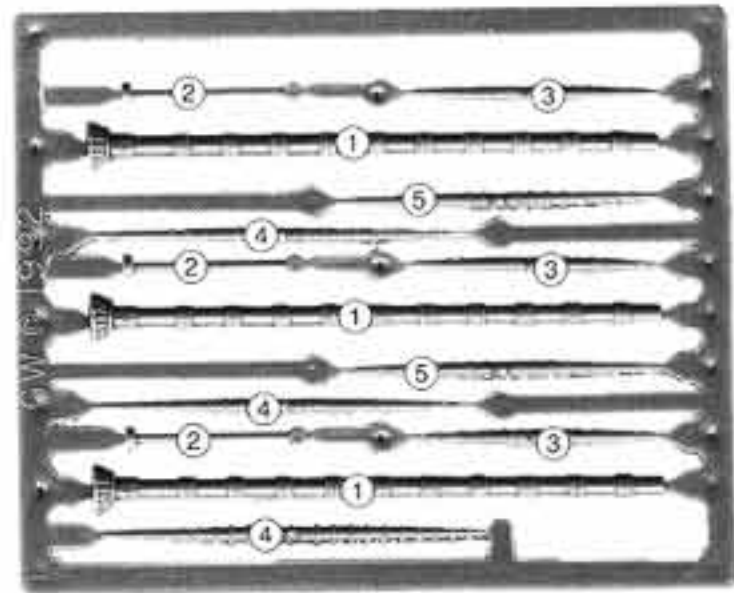
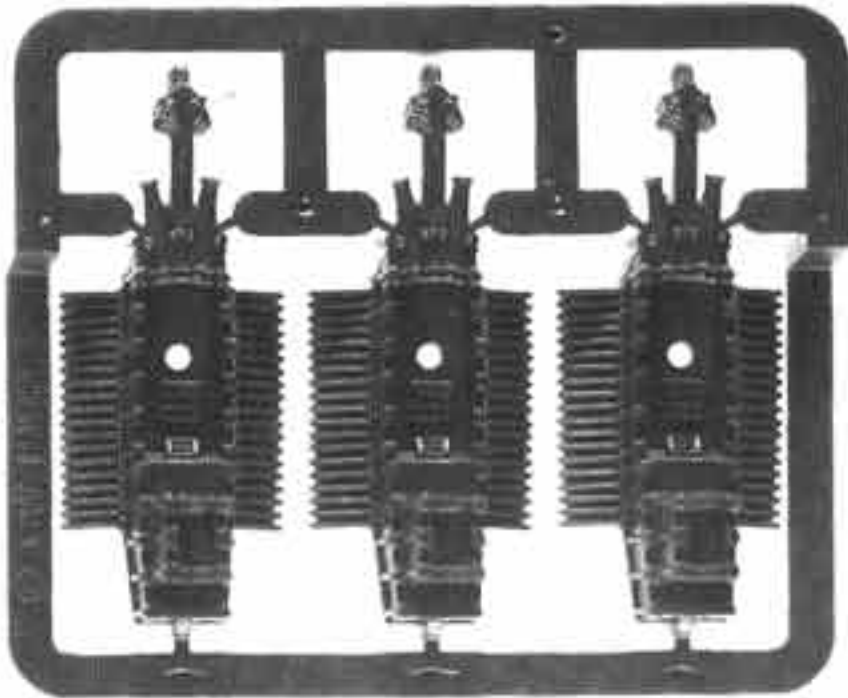

MAN O'WAR PLASTIC MAST SPRUE
MOWPLA/2

HELLHAMMER



CANNON
78064/2



HULL
78064/1

THE COMPLETE
HELLHAMMER
CONSISTS OF:
1 x HELLHAMMER HULL
1 x HELLHAMMER CANNON



THESE SAILS AND PENNANTS MAY BE PHOTOCOPIED,
CUT OUT, PAINTED AND STUCK ONTO YOUR MINIATURES.
PERMISSION GRANTED TO PHOTOCOPY FOR PERSONAL USE ONLY.

CHAOS DWARF SHIPS

THUNDER ROLLERS

THE COMPLETE THUNDER ROLLER
CONSISTS OF:

- 1 x THUNDER ROLLER TOWER
- 1 x THUNDER ROLLER HULL
- 1 x THUNDER ROLLER GUN
- 1 x THUNDER ROLLER



EXAMPLE OF ASSEMBLED AND PAINTED THUNDER ROLLER



THUNDER ROLLER BANNER

THUNDER ROLLER GUN
78055/11

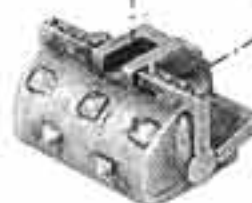

THUNDER ROLLER
78055/10



THUNDER ROLLER TOWER
78055/8



THUNDER ROLLER HULL
78055/9

HULL DESTROYER



HULL DESTROYER BANNER



EXAMPLE OF ASSEMBLED AND PAINTED HULL DESTROYER



HULL DESTROYER TOP
78054/8



HULL DESTROYER BOTTOM
78054/7

THE COMPLETE HULL DESTROYER
CONSISTS OF:

- 1 x HULL DESTROYER TOP
- 1 x HULL DESTROYER BOTTOM

GREAT TAURUS



THE COMPLETE GREAT TAURUS CONSISTS OF:

- 1 x PLASTIC FLYING BASE
- 1 x GREAT TAURUS
- 1 x WINGS 2



WINGS 2
78005/1



GREAT TAURUS
78054/12

Designed by Norman Swales

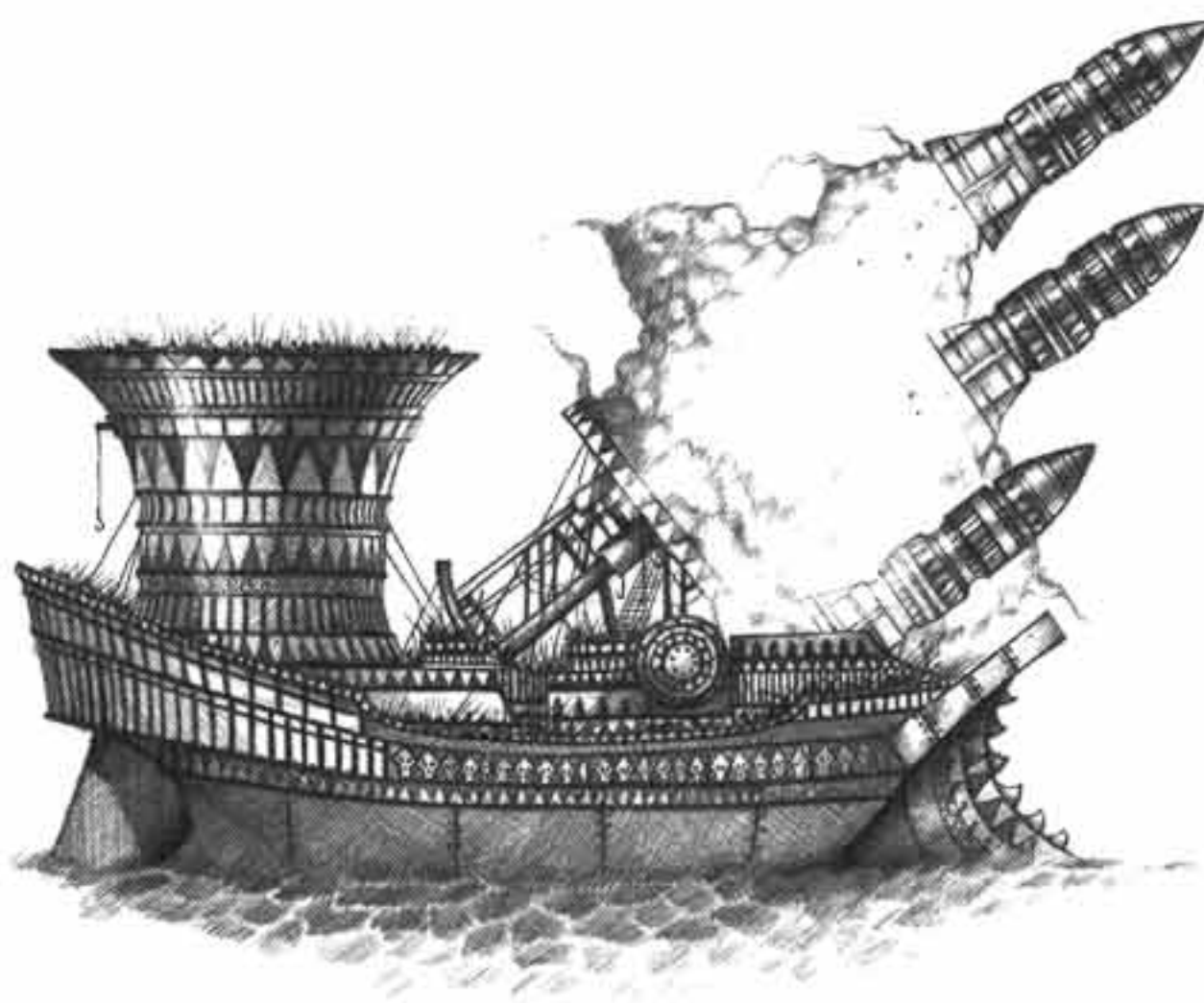

CHAOS DWARF SHIPS

HELLFIRE BATTLEBARGE



EXAMPLE OF ASSEMBLED AND PAINTED HELLFIRE BATTLEBARGE



HELLFIRE BATTLEBARGE BANNER

THE COMPLETE HELLFIRE BATTLEBARGE CONSISTS OF:

- 1 x BATTLEBARGE BANNER POLE
- 1 x BATTLEBARGE TOWER TOP
- 1 x BATTLEBARGE TOWER
- 1 x BATTLEBARGE HULL
- 1 x HELLFIRE CANNON
- 1 x HELLFIRE CANNON RIGHT SUPPORT
- 1 x HELLFIRE CANNON LEFT SUPPORT

HELLFIRE CANNON
78055/7



HELLFIRE CANNON RIGHT SUPPORT
78055/6



HELLFIRE CANNON LEFT SUPPORT
78055/5



BATTLEBARGE BANNER POLE
78054/4



BATTLEBARGE TOWER TOP
78054/3



BATTLEBARGE TOWER
78054/2



BATTLEBARGE HULL
78054/1



GREAT LEVELLER BATTLEBARGE



EXAMPLE OF ASSEMBLED AND PAINTED GREAT LEVELLER BATTLEBARGE

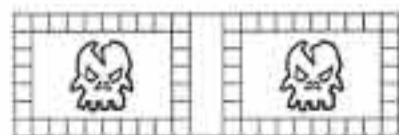

GREAT LEVELLER BATTLEBARGE BANNER

THE COMPLETE GREAT LEVELLER BATTLEBARGE CONSISTS OF:

- 1 x BATTLEBARGE BANNER POLE
- 1 x BATTLEBARGE TOWER TOP
- 1 x BATTLEBARGE TOWER
- 1 x BATTLEBARGE HULL
- 1 x RIGHT MISSILES
- 1 x LEFT MISSILES

GREAT LEVELLER RIGHT MISSILES
78054/6



GREAT LEVELLER LEFT MISSILES
78054/5



BATTLEBARGE BANNER POLE
78054/4



BATTLEBARGE TOWER TOP
78054/3



BATTLEBARGE TOWER
78054/2



BATTLEBARGE HULL
78054/1



© Copyright Games Workshop Ltd 1994. All rights reserved.



DARK ELF WARSHIPS

BLACK ARK OF NAGGAROTH

THE COMPLETE
BLACK ARK OF NAGGAROTH
CONSISTS OF:
2 x LARGE TOWERS
2 x SMALL TOWERS
1 x SKULL PROW
1 x STERN GATE
1 x RIGHT SIDE
1 x LEFT SIDE
1 x DECK 1
2 x DECK 2
2 x PLASTIC MAST SPRUES

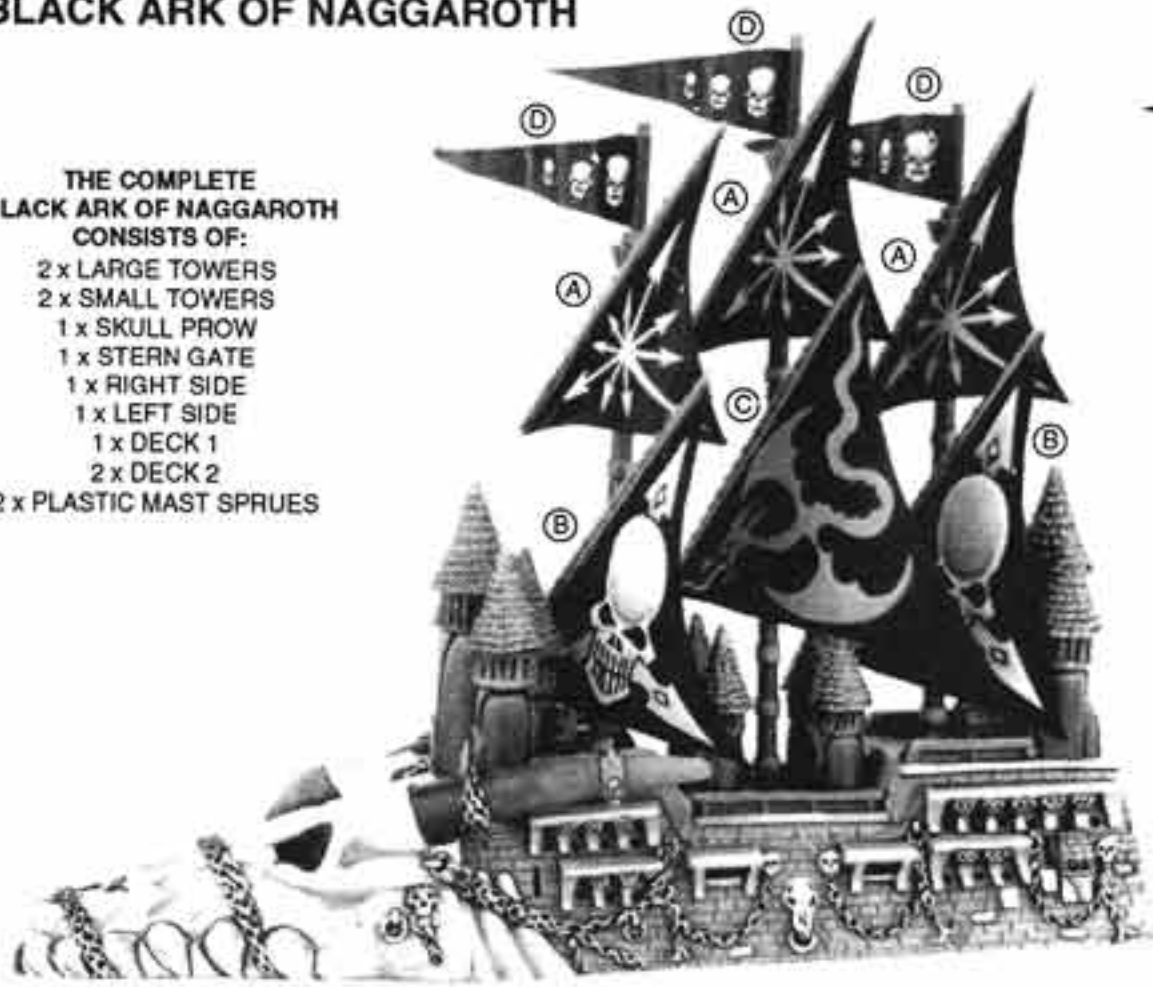

EXAMPLE OF COMPLETED AND FULLY PAINTED BLACK ARK OF NAGGAROTH

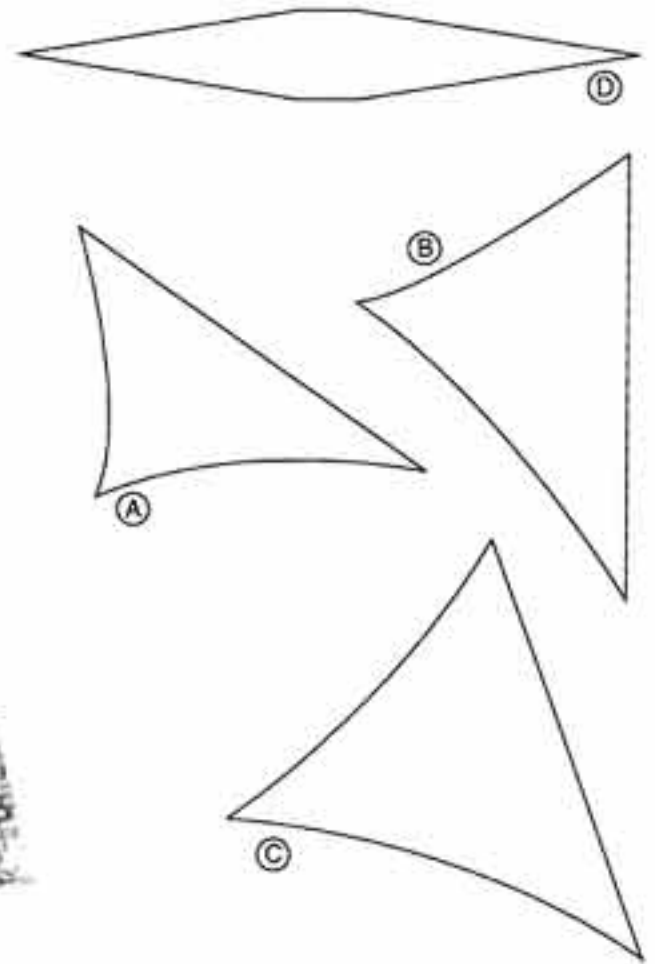

SKULL PROW
78021/1



BLACK ARK SMALL TOWER
78021/5



BLACK ARK DECK 2
78021/8



BLACK ARK DECK 1
78021/7



BLACK ARK STERN GATE
78021/6



BLACK ARK LARGE TOWER
78021/4



BLACK ARK RIGHT SIDE
78021/3



BLACK ARK LEFT SIDE
78021/2

SHIP CONSTRUCTION DIAGRAMS

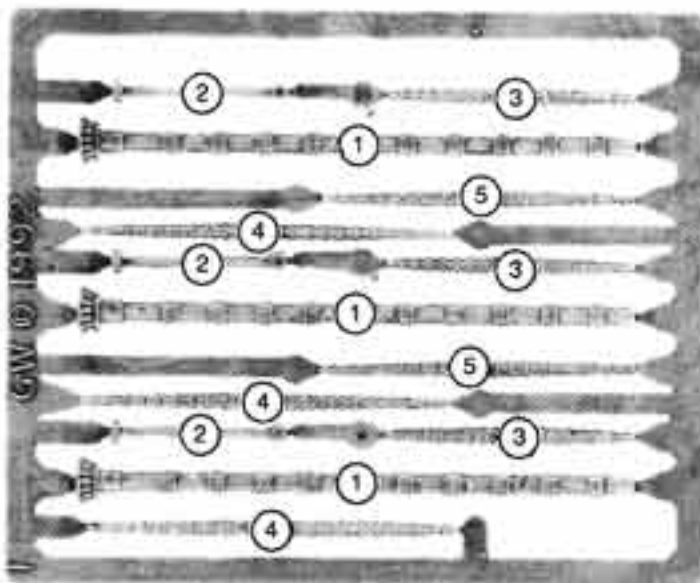

MAN O' WAR PLASTIC MAST SPRUE MOW PLA/2

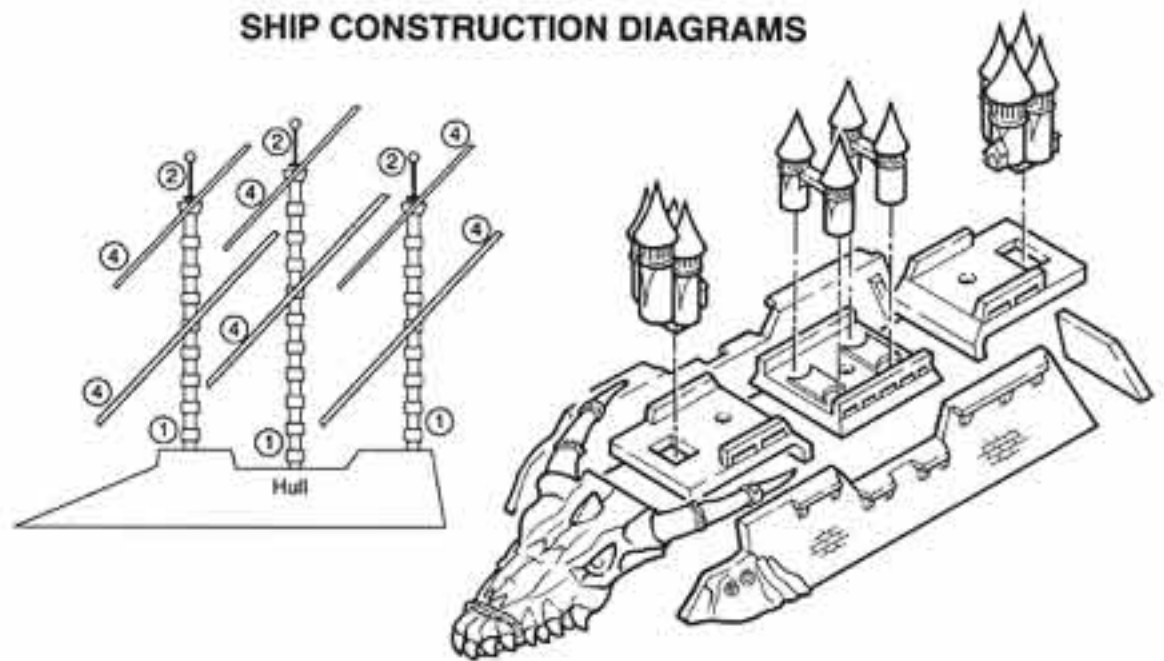

THE DIAGRAM ABOVE ILLUSTRATES THE CORRECT LENGTH FOR EACH MAST AND THE TYPE AND NUMBER OF YARD ARMS.

THE SAILS AND PENNANTS ABOVE MAY BE PHOTOCOPIED, CUT OUT, PAINTED AND STUCK ONTO YOUR MINIATURES.

PERMISSION GRANTED TO PHOTOCOPY FOR PERSONAL USE ONLY.



SKAVEN

DOOMWHEEL



LIGHTNING PROJECTOR
0517/10



WARLOCK
ENGINEER TOP
0517/1



CHAIR BACK
0517/3



WARPSTONE
GENERATOR CHAMBER
0517/8



WARLOCK
ENGINEER BOTTOM
0517/2

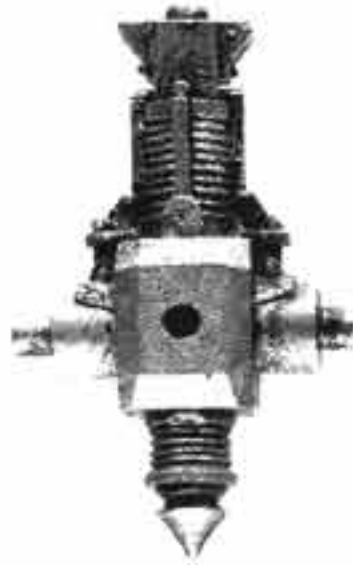

GENERATOR HUB
0517/6



STERN AXLE
0517/7



DOOMWHEEL
0517/4



WHEEL RATS
0517/5



PLASTIC WHEEL



FORWARD
LIGHTNING PROJECTOR
0517/9

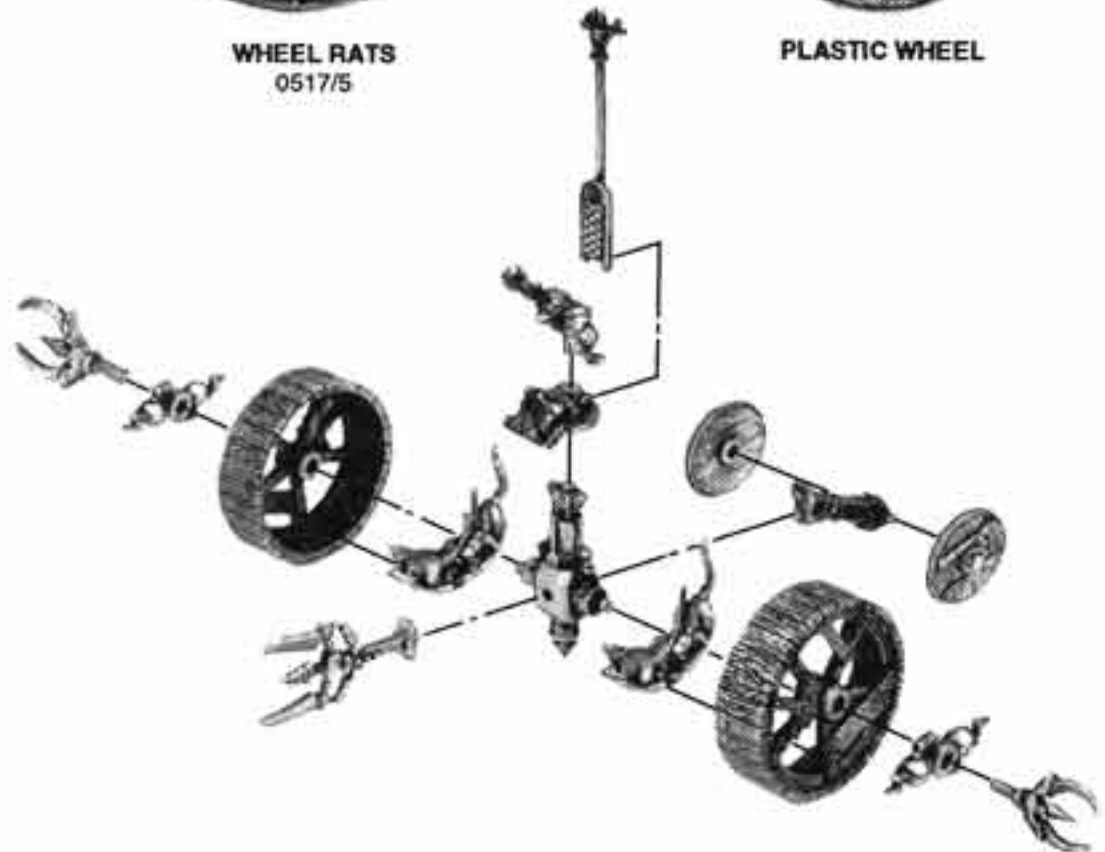

SKAVEN

DOOMWHEEL



**THE COMPLETED DOOMWHEEL
CONSISTS OF:**
1 x WARLOCK ENGINEER TOP
1 x WARLOCK ENGINEER BOTTOM
1 x CHAIR BACK
1 x GENERATOR HUB
1 x STERN AXLE
1 x FORWARD LIGHTNING PROJECTOR
2 x LIGHTNING PROJECTOR
2 x WARPSTONE GENERATOR CHAMBER
2 x DOOMWHEEL
2 x WHEEL RATS
2 x SOLID PLASTIC WHEELS

EXAMPLE OF COMPLETED DOOMWHEEL

Designed by Jes Goodwin and Norman Swales



SKAVEN

GREY SEER THANQUOL AND BONERIPPER



EXAMPLE OF COMPLETED BONERIPPER



GREY SEER
THANQUOL
74464/1



BONERIPPER
HEAD
74467/1



BONERIPPER
TORSO
74467/2



BONERIPPER
LEFT ARM
74467/3

THE COMPLETE BONERIPPER
CONSISTS OF:
1 x BONERIPPER HEAD
1 x BONERIPPER TORSO
1 x BONERIPPER LEGS
1 x BONERIPPER LEFT ARM



BONERIPPER
LEGS
74467/4



SKAVEN

LORDS



LORD SKROLK
74463/1

THE COMPLETED DEATHMASTER
SNIKCH
CONSISTS OF:
1 x DEATHMASTER SNIKCH BODY
1 x SWORD ARM



DEATHMASTER SNIKCH BODY
74462/2



SWORD ARM
74462/3



EXAMPLE OF COMPLETED
DEATHMASTER SNIKCH



EXAMPLE OF COMPLETED WARLORD QUEEK

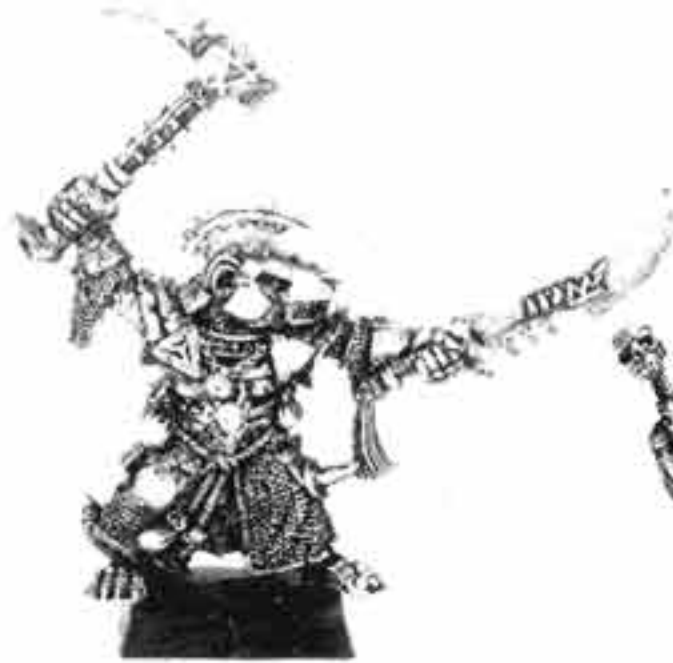

WARLORD QUEEK
74465/1



QUEEK'S TROPHY RACK
74465/2

THE COMPLETED IKIT CLAW CHIEF WARLOCK
CONSISTS OF:
1 x IKIT CLAW
1 x BANNER



IKIT CLAW
CHIEF WARLOCK
74466/1



IKIT CLAW'S BANNER
74466/2



EXAMPLE OF COMPLETED IKIT CLAW

SKAVEN

CLAN MOULDER PACK MASTERS



PACK MASTER
WITH WHIP 1
74461/45



PACK MASTER
WITH WHIP 2
74461/85



PACK MASTER WITH
WHIP AND SWORD
74461/50



THROT THE UNCLEAN
74461/19



GIANT RAT 5
74461/5



GIANT RAT 6
74461/2



GIANT RAT 7
74461/1



GIANT RAT 8
74461/4



GIANT RAT 9
74461/3

GUTTER RUNNERS



GUTTER RUNNER
WITH DAGGER 1
74455/7



GUTTER RUNNER WITH
DAGGER AND NET 1
74455/5



GUTTER RUNNER WITH
DAGGER AND NET 2
74455/6



GUTTER RUNNER
WITH DAGGER 3
74455/8



GUTTER RUNNER WITH
SHURIKEN AND DAGGER
74455/91



GUTTER RUNNER
WITH DAGGER 3
74455/89



GUTTER RUNNER WITH
DAGGER AND NET 3
74455/90



GUTTER RUNNER
WITH TWO DAGGERS
74455/88

SKAVEN

VERMIN LORD, GREATER DAEMON OF THE HORNED RAT

THE COMPLETED VERMIN LORD
CONSISTS OF:
1 X HEAD
1 X TORSO
1 X LEGS
1 X LEFT ARM
1 X RIGHT ARM
1 X TAIL



EXAMPLE OF COMPLETED VERMIN LORD



HEAD
0516/1



TORSO
0516/2



LEGS
0516/3



RIGHT ARM
WITH HALBERD
0516/4



LEFT ARM
0516/5



TAIL
0516/6



SKAVEN

SKAVEN SCREAMING BELL

THE COMPLETE SCREAMING BELL CONSISTS OF:
 1 x GREY SEER
 1 x BELL STRIKER
 1 x PLATFORM
 2 x BELL SUPPORTS
 2 x BELL HALVES
 1 x COUNTERWEIGHT
 1 x WARPSTONE BRAZIER
 1 x BELL CLANGER
 6 x PLASTIC WHEELS

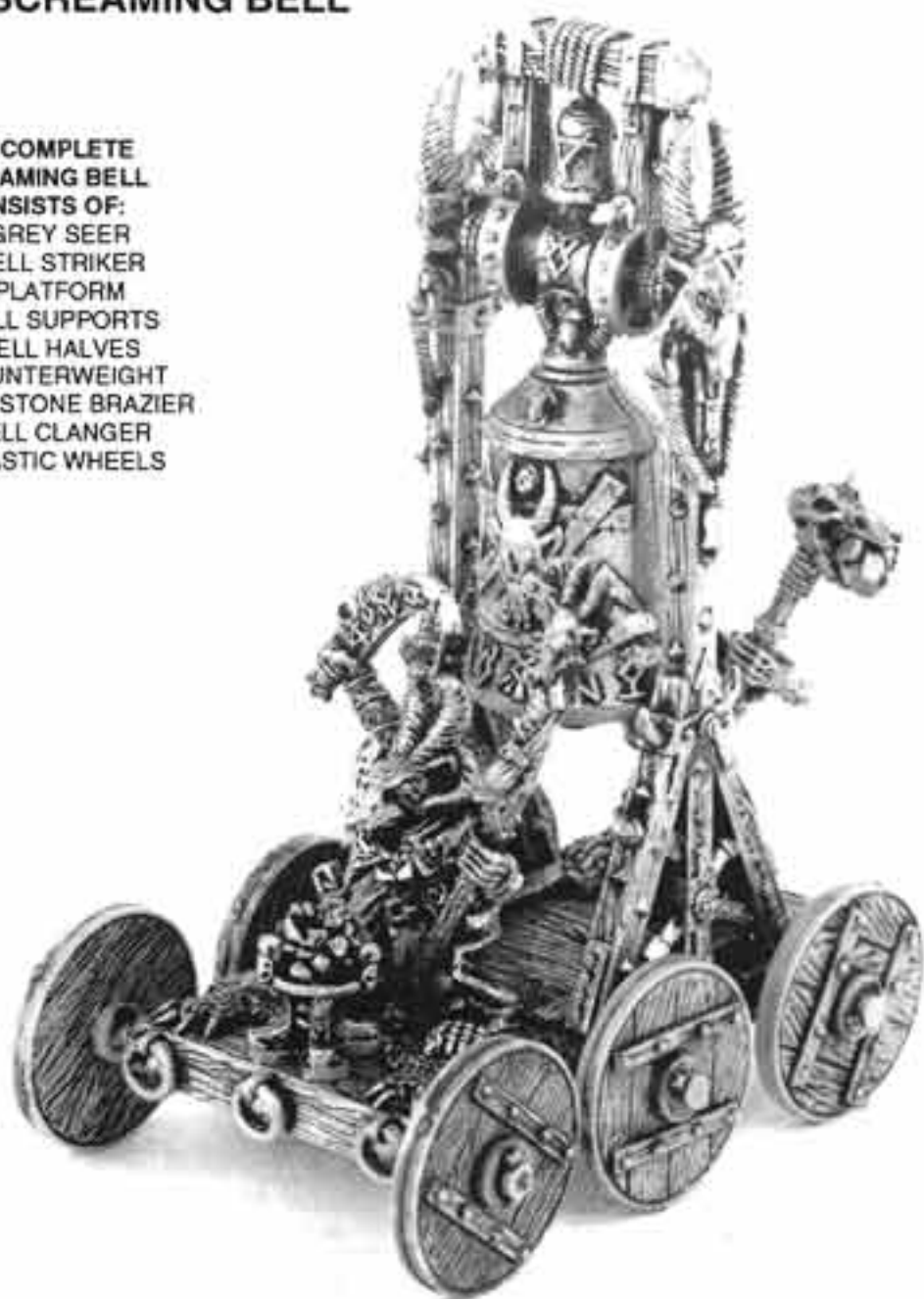

GREY SEER
0839/1



BELL STRIKER
0839/2



WARPSTONE BRAZIER
0839/7

EXAMPLES OF COMPLETED SKAVEN SCREAMING BELL

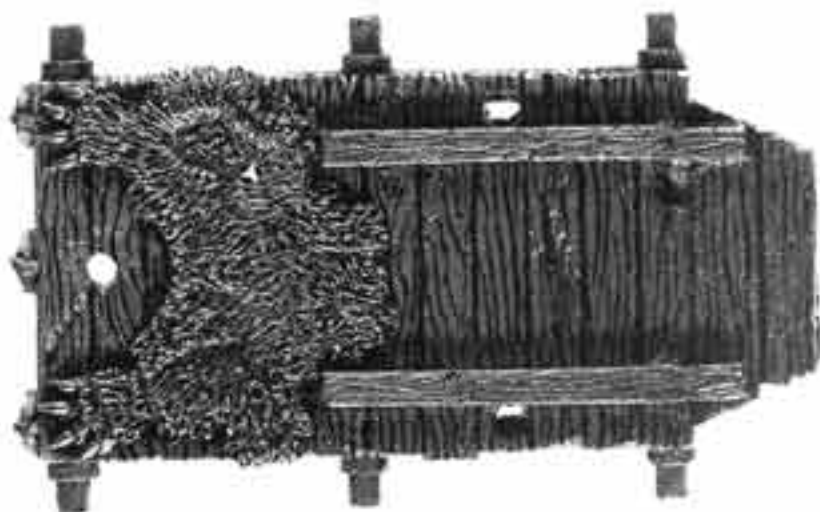

PLATFORM
0839/3



BELL CLANGER
0839/8



PLASTIC WHEEL
100558



BELL SUPPORT
0839/4



COUNTERWEIGHT
0839/6



BELL HALF
0839/5

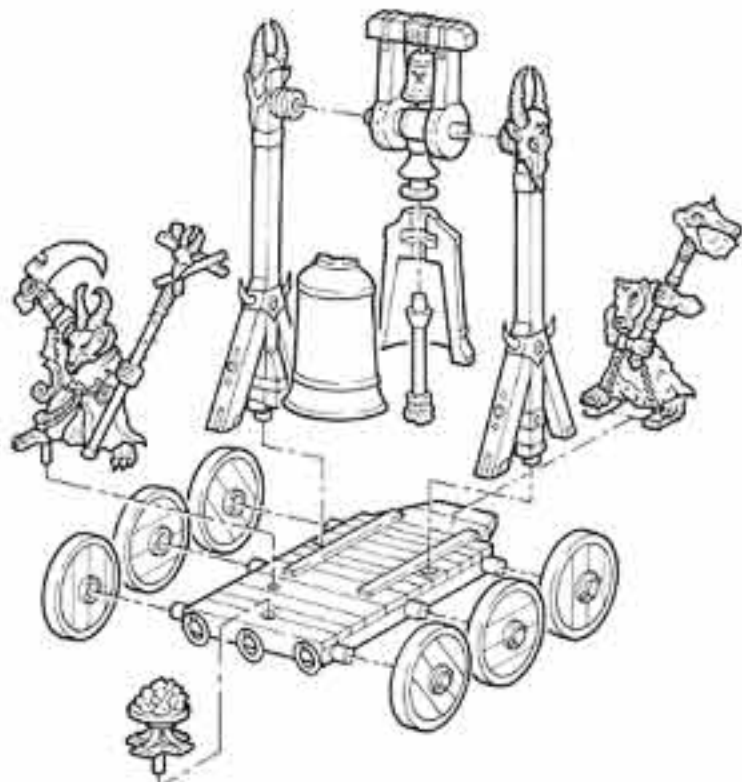

© Copyright Games Workshop Ltd 1993. All rights reserved.



CITIZEN MINIATURES

Designed Jes Goodwin and Norman Swales

SKAVEN

SKAVEN JEZZAIL



JEZZAIL 1
74469/1



JEZZAIL REST 1
7469/2



JEZZAIL 2
74469/3



JEZZAIL REST 2
7469/4



EXAMPLE OF COMPLETED SKAVEN JEZZAIL TEAM

THE COMPLETED SKAVEN JEZZAIL
TEAM CONSISTS OF:
1 x JEZZAIL
1 x JEZZAIL REST

CLAN SKRYRE POISONED WIND GLOBADIERS



GLOBADIER 1
74458/2



GLOBADIER 2
74458/3



GLOBADIER BACKPACK
74458/4

EXAMPLES OF COMPLETED POISONED WIND GLOBADIERS



THE COMPLETED POISONED WIND
GLOBADIERS CONSIST OF:
1 x GLOBADIER
1 x GLOBADIER BACKPACK

© Copyright Games Workshop Ltd 1994. All rights reserved.



ADEL
ARTURES

SKAVEN

CLAN PESTILENS PLAGUE MONK COMMAND



CHAMPION
74451/5



MUSICIAN
74451/7



STANDARD BEARER
74451/6

STORMVERMIN COMMAND



MUSICIAN
74451/10

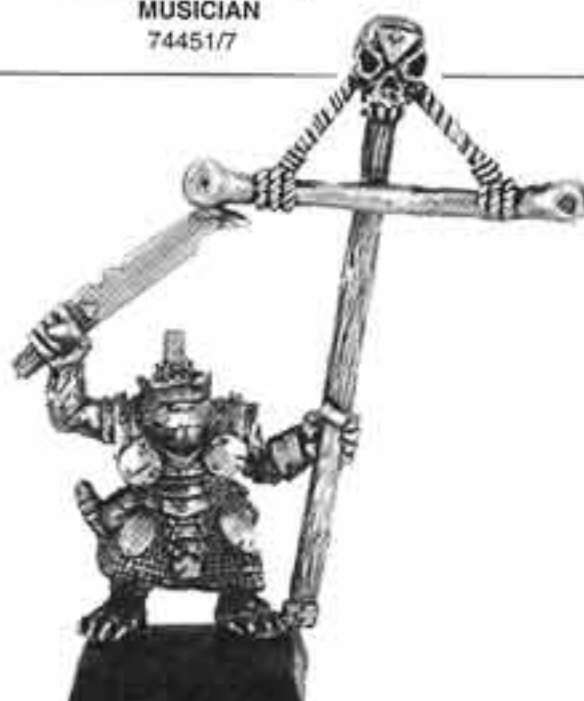

STANDARD BEARER
74451/9



CHAMPION
74451/8

CLAN SKRYRE POISONED WIND GLOBADIERS



GLOBADIER 1
74458/2



GLOBADIER 2
74458/3



GLOBADIER BACKPACK
74458/4

THE COMPLETED POISONED WIND
GLOBADIERS CONSIST OF:
1 x GLOBADIER
1 x GLOBADIER BACKPACK

EXAMPLES OF COMPLETED POISONED WIND GLOBADIERS



SKAVEN

STORMVERMIN

THESE FIGURES ARE SUPPLIED WITH PLASTIC SHIELDS WHERE APPROPRIATE



STORMVERMIN
WITH HALBERD 4
74453/71

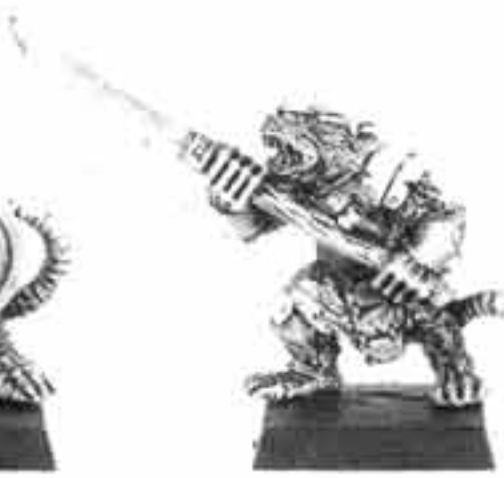

STORMVERMIN
WITH HALBERD 5
74453/73



STORMVERMIN
WITH HALBERD 6
74453/72



STORMVERMIN
WITH HALBERD 7
74453/74

PLAGUE MONKS



PLAGUE MONK 1
74454/75



PLAGUE MONK 2
74454/76



PLAGUE MONK 3
74454/77



PLAGUE MONK 4
74454/78

PLAGUE CENSER BEARERS



CENSER BEARER 1
74459/86



CENSER BEARER 2
74459/81



CENSER BEARER 3
74459/87



CENSER BEARER 4
74459/80

SKAVEN

RAT OGRES



RAT OGRE
HEAD 1
74460/2



RAT OGRE
HEAD 2
74460/3



RAT OGRE
HEAD 3
74460/1



RAT OGRE
TORSO 1
74460/5



RAT OGRE
TORSO 2
74460/4



RAT OGRE
TORSO 3
74460/6



RAT OGRE
LEGS 1
74460/7



RAT OGRE
LEGS 2
74460/8

THE COMPLETED RAT OGRE
MODELS CONSIST OF:
1 X RAT OGRE HEAD
1 X RAT OGRE TORSO
1 X RAT OGRE LEGS



EXAMPLES OF COMPLETED RAT OGRES

CHAOS

FLESH HOUNDS OF KHORNE



EXAMPLE OF ASSEMBLED
KHORNE FLESH HOUND 1



EXAMPLE OF ASSEMBLED
KHORNE FLESH HOUND 2



EXAMPLE OF ASSEMBLED
KHORNE FLESH HOUND 3



FLESH HOUND 1 LEFT BODY
73006/10



FLESH HOUND 2 LEFT BODY
73006/1



FLESH HOUND 3 LEFT BODY
73006/6



FLESH HOUND 1 RIGHT BODY
73006/11

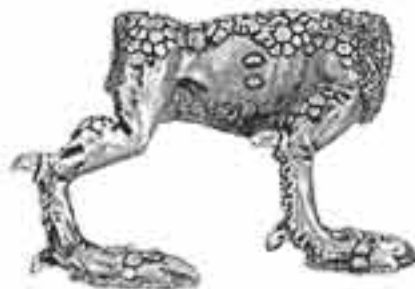

FLESH HOUND 2 RIGHT BODY
73006/2



FLESH HOUND 3 RIGHT BODY
73006/7



FLESH HOUND 1 RUFF
73006/14



FLESH HOUND 2 RUFF
73006/5



FLESH HOUND 3 TAIL
73006/9



FLESH HOUND 1 TAIL
73006/13



FLESH HOUND 2 TAIL
73006/4



FLESH HOUND 1 HEAD
73006/12



FLESH HOUND 2 HEAD
73006/3



FLESH HOUND 3 HEAD
73006/8

CHAOS

CHAOS WARRIORS



CHAOS CHAMPION
73005/1



CHAOS DRUMMER
73005/4



CHAOS STANDARD BEARER
73005/2

THE COMPLETED CHAOS WARRIOR
STANDARD BEARER CONSISTS OF:
1 x CHAOS STANDARD BEARER BODY
1 x CHAOS STANDARD TOP



CHAOS STANDARD TOP
73005/3



EXAMPLE OF COMPLETED CHAOS STANDARD BEARER



CHAOS WARRIOR 2
73007/3



CHAOS WARRIOR 1
73007/2



CHAOS WARRIOR 3
73007/6

CHAOS

DRAGON OGRES



OGRE TORSO A1
73003/4



OGRE TORSO B1
73003/6



OGRE TORSO C1
73003/14



DRAGON OGRE LEG 1
73003/2



OGRE TORSO A2
73003/12



OGRE TORSO B2
73003/13



OGRE TORSO C2
73003/8



DRAGON OGRE LEG 2
73003/15

LEG 1 FITS BODY 1
LEG 2 FITS BODY 2



DRAGON OGRE ARM 'A'
73003/5



DRAGON OGRE ARM 'B'
73003/7



DRAGON OGRE ARM 'C'
73003/9



DRAGON OGRE CLAW 1
73003/3



DRAGON OGRE CLAW 2
73003/11

A COMPLETED DRAGON OGRE
CONSISTS OF:

- 1 x OGRE TORSO
- 1 x WEAPON ARM
- 1 x DRAGON OGRE BODY
- 1 x DRAGON OGRE LEG
- 1 x DRAGON OGRE CLAW

ARM 'A' FITS TORSOS A1 AND A2 ONLY; ARM 'B' TORSOS FITS B1 AND B2; ARM 'C' FITS TORSOS C1 AND C2



DRAGON OGRE BODY 1
73003/1



DRAGON OGRE BODY 2
73003/10



EXAMPLE OF A COMPLETED DRAGON OGRE

© Copyright Games Workshop Ltd. 1994. All Rights Reserved.



CHAOS

CHAOS KNIGHTS



CHAOS CHAMPION
73004/2

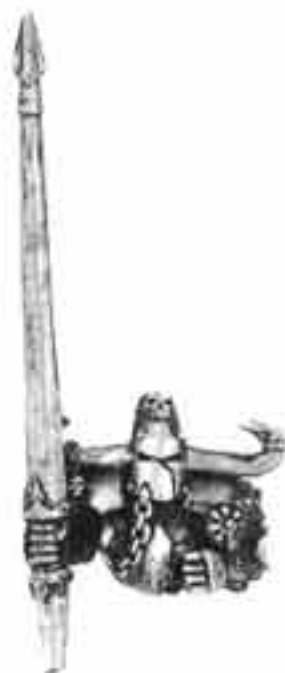

CHAOS KNIGHT 1
0525/4



CHAOS KNIGHT 2
0525/3



CHAOS KNIGHT 3
0525/2



CHAOS KNIGHT
STANDARD BEARER
73004/3



CHAOS KNIGHT LEGS
0525/1

A COMPLETED CHAOS KNIGHT
CONSISTS OF:
1 x CHAOS KNIGHT
1 x CHAOS KNIGHT LEGS
1 x CHAOS STEED HEAD
1 x PLASTIC ARMoured HORSE SPRUE



CHAOS KNIGHT BANNER TOP
73004/4



CHAOS STEED HEAD 1
0525/5



CHAOS STEED HEAD 2
0525/6



CHAOS STEED HEAD 3
0525/7



CHAOS STEED HEAD 4
73004/5



CHAOS STEED HEAD 5
73004/6



THESE MODELS ARE SUPPLIED WITH A PLASTIC ARMoured HORSE SPRUE AND APPROPRIATE PLASTIC SHIELDS AS STANDARD

CHAOS

BLOODLETTERS OF KHORNE



BLOODLETTER 4
73007/1



BLOODLETTER 1
73007/4



BLOODLETTER 3
73007/2



BLOODLETTER 2
73007/3

DAEMONETTES OF SLAANESH



DAEMONETTE 1
73008/3



DAEMONETTE 2
73008/4



DAEMONETTE 4
73008/1



DAEMONETTE 3
73008/2

CHAOS WARRIORS



CHAOS WARRIOR 3
73201/53



CHAOS WARRIOR 1
73201/54



CHAOS WARRIOR 2
73201/55

CHAOS

CHAOS BEASTMEN



BEASTMAN
HORNBLOWER 1
73001/7



BEASTMAN
SHAMAN 2
73002/2



BEASTMAN
HORNBLOWER 2
73001/8



BEASTMAN
CHAMPION 2
73001/2



BEASTMAN
CHAMPION 1
73001/1

A COMPLETED BEASTMAN
STANDARD BEARER
CONSISTS OF:
1 x BEASTMAN
STANDARD BEARER
1 x BEASTMAN BANNER TOP



BEASTMAN
STANDARD BEARER 2
73001/4



BEASTMAN
STANDARD BEARER 1
73001/3



BEASTMAN 2
73000/2



BEASTMAN
SHAMAN 1
73002/1



BEASTMAN 4
73000/4



BEASTMAN BANNER TOP 1
73001/5



BEASTMAN BANNER TOP 2
73001/6



BEASTMAN 7
73000/7



BEASTMAN 3
73000/3



BEASTMAN 5
73000/5



BEASTMAN 8
73000/8



BEASTMAN 6
73000/6



BEASTMAN 1
73000/1

UNDEAD

SKELETON HORSEMEN



SKELETON HORSEMAN
WITH BOW
74519/4



SKELETON HORSEMAN
WITH AXE
74519/2



SKELETON HORSEMAN
WITH SWORD
74519/1



SKELETON HORSEMAN
WITH SPEAR
74519/3

THESE MODELS ARE SUPPLIED WITH PLASTIC SHIELDS WHERE APPROPRIATE AND A PLASTIC SKELETON STEED SPRUE AS STANDARD



EXAMPLES OF COMPLETED SKELETON HORSEMEN

UNDEAD

LICHE KING'S CHARIOT



WHEEL
0519/9



CHARIOT BASE
0519/2



LECTERN
0519/7



LEFT WING
0519/4



RIGHT WING
0519/3



YOKE
0519/6



CHARIOT HAFT
0519/5



BANNER
0519/8



LICHE KING
0519/1



© Copyright Games Workshop Ltd 1994. All rights reserved.



CITADEL
MINIATURES

UNDEAD

LICHE KING'S CHARIOT



- THE COMPLETED LICHE KING'S CHARIOT CONSISTS OF:**
- 1 X LICHE KING
 - 1 X CHARIOT BASE
 - 1 X LECTERN
 - 1 X CHARIOT HAFT
 - 1 X BANNER
 - 1 X LEFT WING
 - 1 X RIGHT WING
 - 2 X YOKE
 - 2 X WHEEL
 - 4 X PLASTIC SKELETON HORSES

EXAMPLE OF COMPLETED LICHE KING'S CHARIOT

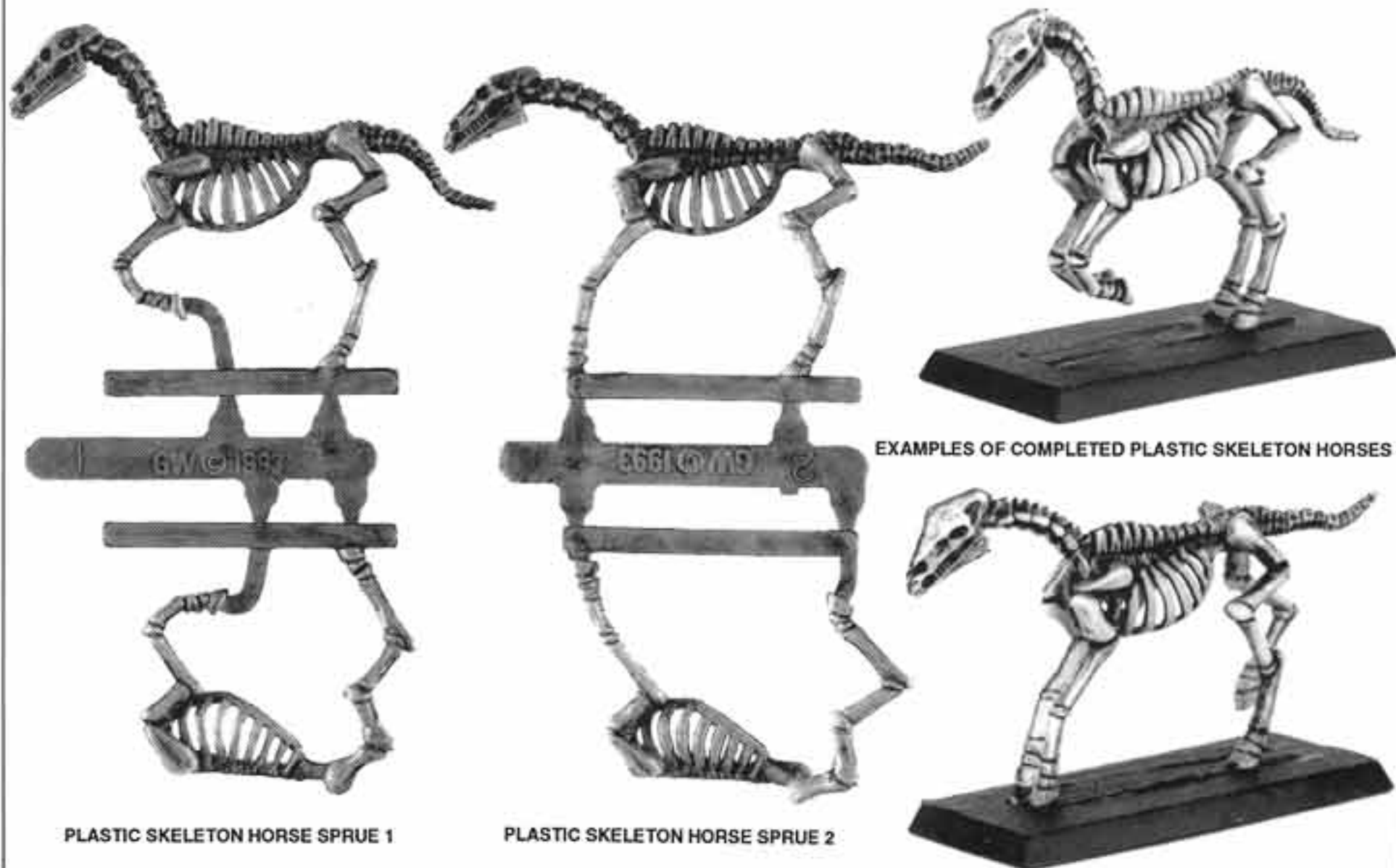

EXAMPLES OF COMPLETED PLASTIC SKELETON HORSES

PLASTIC SKELETON HORSE SPRUE 1

PLASTIC SKELETON HORSE SPRUE 2

UNDEAD

WIGHTS

THESE FIGURES ARE SUPPLIED WITH PLASTIC SHIELDS WHERE APPROPRIATE



WIGHT 1
74517/4



WIGHT 2
74517/3



WIGHT 3
74517/2



WIGHT 4
74517/1



WIGHT 5
74517/7



WIGHT 6
74517/5



WIGHT 7
74517/8



WIGHT 8
74517/6

VAMPIRE LORD



VAMPIRE LORD
74520/1

THE COMPLETED VAMPIRE LORD CONSISTS OF:
1 x VAMPIRE LORD BODY
1 x CLOAK



CLOAK
74520/2



EXAMPLE OF COMPLETED VAMPIRE LORD

NECROMANCER



NECROMANCER
74521/1



UNDEAD

DIETER HELSNICHT ON MANTICORE



THE COMPLETED DIETER HELSNICHT ON MANTICORE CONSISTS OF:

- 1 x BANNER TOP
- 1 x DIETER HELSNICHT LEGS
- 1 x DIETER HELSNICHT BODY
- 1 x MANTICORE HEAD
- 1 x MANTICORE LEFT BODY
- 1 x MANTICORE RIGHT BODY
- 1 x BACK LEG
- 1 x FRONT PAW
- 1 x MANTICORE TAIL
- 1 x LEFT WING
- 1 x RIGHT WING

EXAMPLE OF COMPLETED DIETER HELSNICHT ON MANTICORE



BANNER TOP
0518/3



DIETER HELSNICHT BODY
0518/1



DIETER HELSNICHT LEGS
0518/2

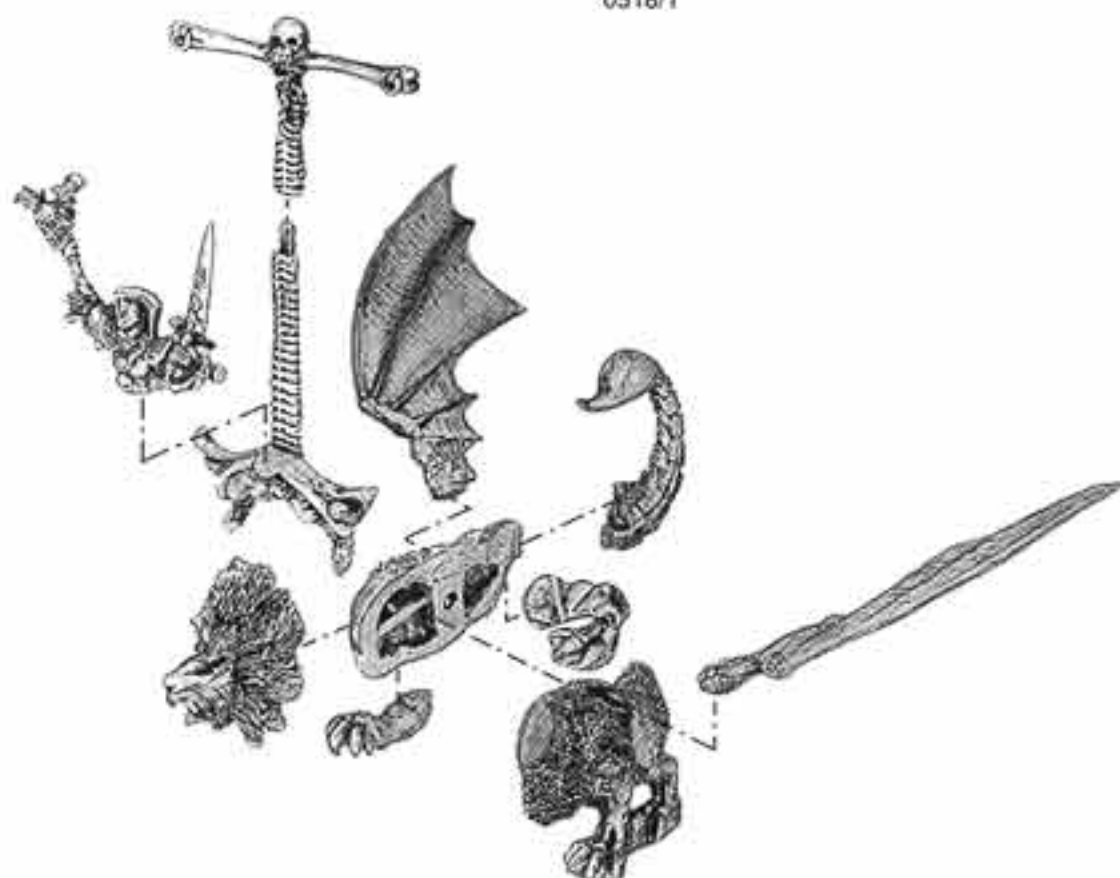

UNDEAD

MANTICORE



LEFT WING
0810/5



RIGHT WING
0810/6



MANTICORE HEAD
0518/4



MANTICORE TAIL
0518/9



MANTICORE RIGHT BODY
0518/6



MANTICORE LEFT BODY
0518/5



MANTICORE BACK LEG
0518/7



MANTICORE FRONT PAW
0518/8

MUMMIES



MUMMY 2
74510/4



MUMMY 1
74510/3



MUMMY 3
74510/2



MUMMY 4
74510/6



MUMMY 5
74510/7



MUMMY 6
74510/1



MUMMY 7
74510/8



MUMMY 8
74510/5

Designed by Gary Morley and Trish Morrison

UNDEAD

ZOMBIES

THESE FIGURES ARE SUPPLIED WITH PLASTIC SHIELDS WHERE APPROPRIATE



ZOMBIE STANDARD BEARER 1
74514/1



ZOMBIE MUSICIAN
74514/2



ZOMBIE STANDARD BEARER 2
74514/3



ZOMBIE 1
74515/5



ZOMBIE 2
74515/13



ZOMBIE 3
74515/9



ZOMBIE 4
74515/7



ZOMBIE 5
74515/11



ZOMBIE 6
74515/6



ZOMBIE 7
74515/10



ZOMBIE 8
74515/8



ZOMBIE 9
74515/12



ZOMBIE 10
74515/4



ZOMBIE 11
74515/2



ZOMBIE 12
74515/3



ZOMBIE 13
74515/1

Designed by Gary Morley

UNDEAD

SKELETON COMMAND



**SKELETON STANDARD
BEARER 1**
74516/7



**SKELETON STANDARD
BEARER 2**
74516/5



**SKELETON STANDARD
BEARER 3**
74516/6



SKELETON DRUMMER 1
74516/2



SKELETON HORNBLOWER
74516/1



SKELETON DRUMMER 2
74516/3

CARRION



EXAMPLE OF COMPLETED CARRION



CARRION HEAD 1
88420/3



CARRION HEAD 2
88420/4



CARRION HEAD 3
88420/5



CARRION WINGS
88420/2



CARRION BODY
88420/1



CARRION RIDER 1
88420/7



CARRION RIDER 2
88420/6

THE COMPLETED CARRION
CONSISTS OF:
1 x CARRION RIDER
1 x CARRION HEAD
1 x CARRION BODY
1 x CARRION WINGS

PLASTICS

SKELETON WARRIORS

THESE FIGURES ARE SUPPLIED WITH A PLASTIC SHIELD SPRUE AS STANDARD

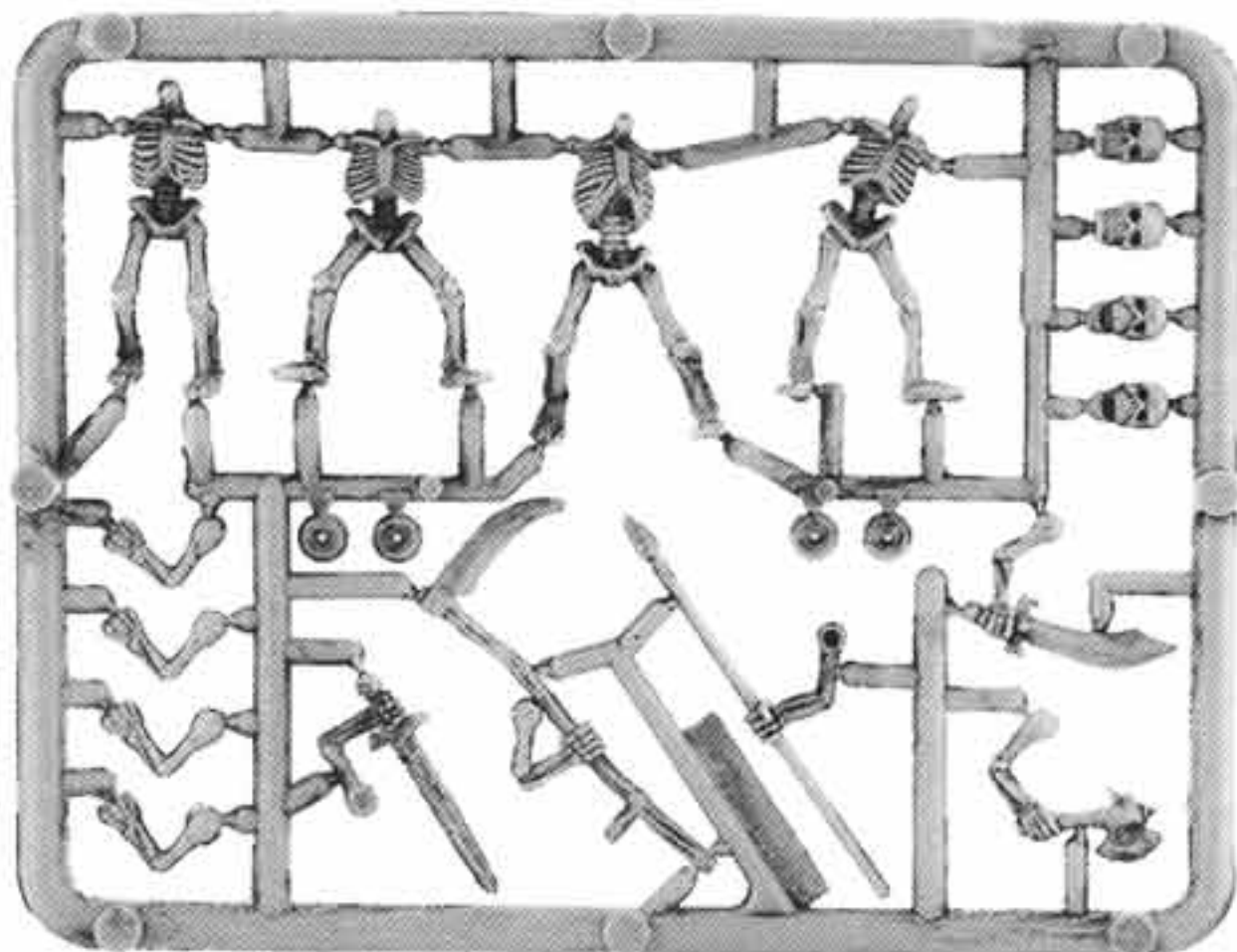

SKELETON WARRIORS SPRUE 101462



EXAMPLES OF COMPLETED PLASTIC SKELETON WARRIORS

SKELETON HORSEMEN

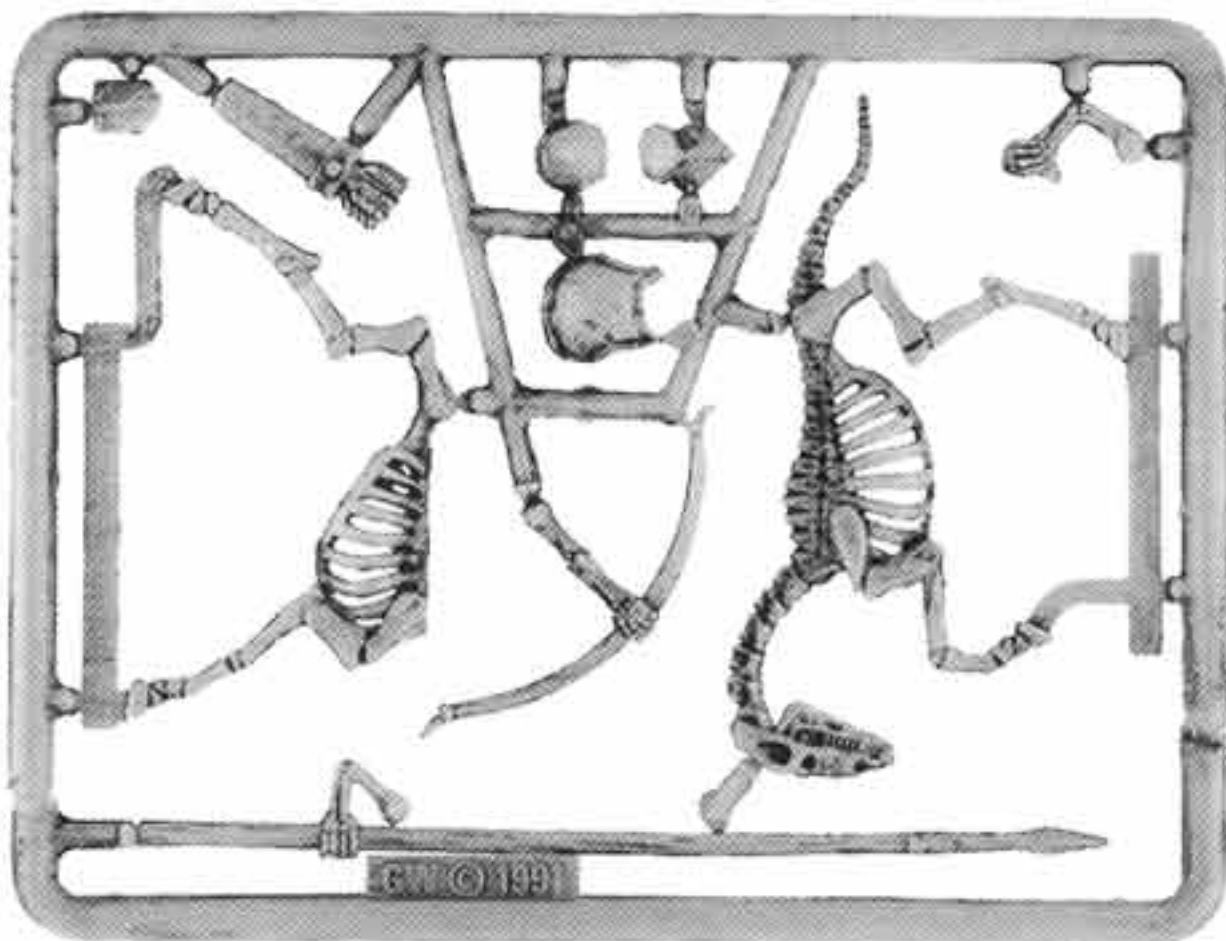

SKELETON HORSE SPRUE 129843

THE COMPLETE SKELETON HORSEMAN
CONSISTS OF:
1 x PLASTIC SKELETON WARRIORS SPRUE
1 x PLASTIC SKELETON HORSE SPRUE
1 x PLASTIC SHIELD SPRUE

NOTE: ONLY THREE OF THE FOUR
PLASTIC SKELETON WARRIOR BODIES
CAN BE MOUNTED ON THE HORSE.

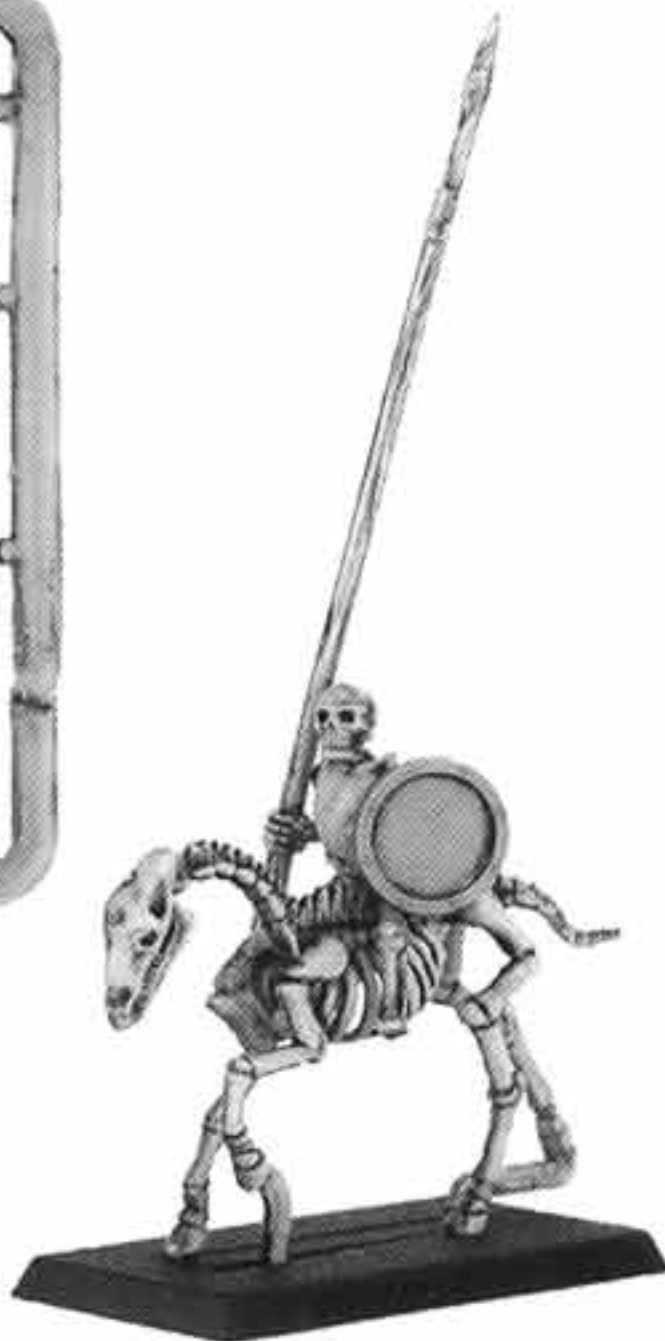

EXAMPLE OF COMPLETED PLASTIC SKELETON HORSEMAN

PLASTICS

UNDEAD CHARIOT

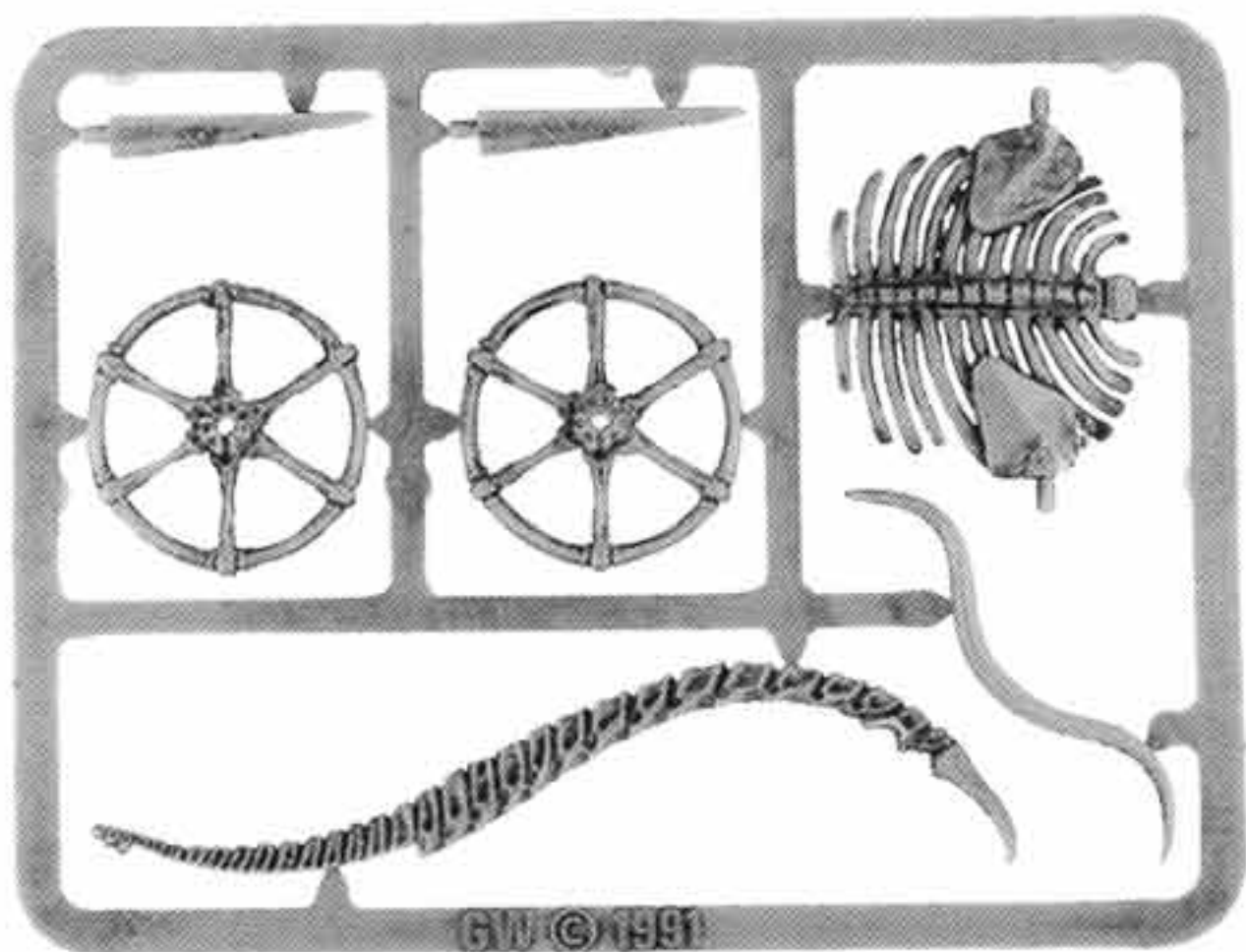

UNDEAD CHARIOT SPRUE 131769

THE COMPLETE UNDEAD CHARIOT CONSISTS OF:

- 1 x PLASTIC SKELETON WARRIORS SPRUE
- 2 x PLASTIC SKELTON HORSE SPRUE
- 1 x PLASTIC UNDEAD CHARIOT SPRUE
- 1 x PLASTIC SHIELD SPRUE



EXAMPLE OF THE COMPLETED PLASTIC UNDEAD CHARIOT

UNDEAD

ZOMBIE DRAGON



EXAMPLE OF THE COMPLETED ZOMBIE DRAGON AND RIDER



ZOMBIE DRAGON
RIDER TORSO
0524/11



BANNER
0524/13



ZOMBIE DRAGON
RIDER LEGS
0524/12



BACK LEFT LEG
0524/8



BACK RIGHT LEG
0524/7



FRONT LEFT LEG
0524/6



FRONT RIGHT LEG
0524/5



BODY
0524/3



NECK
0524/2



HEAD
0524/1



TAIL
0524/4

THE COMPLETED ZOMBIE DRAGON AND RIDER CONSISTS OF:

- 1 x RIDER TORSO
- 1 x RIDER LEGS
- 1 x BANNER
- 1 x BODY
- 1 x HEAD
- 1 x NECK
- 1 x FRONT LEFT LEG
- 1 x FRONT RIGHT LEG
- 1 x BACK LEFT LEG
- 1 x BACK RIGHT LEG
- 1 x TAIL
- 1 x LEFT WING
- 1 x RIGHT WING

UNDEAD

ZOMBIE DRAGON



LEFT WING
0524/10

RIGHT WING
0524/9



NECROMANCERS



NECROMANCER 1
74521/1



NECROMANCER 2
74521/2

UNDEAD

NAGASH



EXAMPLE OF COMPLETED NAGASH



HEAD
0523/4

THE COMPLETED NAGASH
CONSISTS OF:
1 x HEAD
1 x TORSO
1 x FRONT BODY
1 x REAR BODY
1 x STAFF
1 x SWORD



TORSO
0523/3



SWORD
0523/6



STAFF
0523/5



FRONT BODY
0523/2



REAR BODY
0523/1



UNDEAD

GHOULS



GHOUL 1
74522/1



GHOUL 2
74522/2



GHOUL 3
74522/3



GHOUL 4
74522/4



GHOUL 5
74522/5



GHOUL 6
74522/6



GHOUL 7
74522/7



GHOUL 8
74522/8



GHOUL 9
74522/9



GHOUL 10
74522/10



GHOUL 11
74522/11



GHOUL 12
74522/12

© Copyright Games Workshop Ltd 1994. All rights reserved.



GADELS
ENTERTAINMENT

UNDEAD

MUMMIES



MUMMY 2
74510/4



MUMMY 1
74510/3



MUMMY 3
74510/2



MUMMY 4
74510/6



MUMMY 5
74510/7



MUMMY 6
74510/1



MUMMY 7
74510/8



MUMMY 8
74510/5

WRAITHS



WRAITH 8
74518/8



WRAITH 7
74518/7



WRAITH 5
74518/5



WRAITH 6
74518/6



WRAITH 4
74518/4



WRAITH 1
74518/1



WRAITH 2
74518/2



WRAITH 3
74518/3

ORCS

MORGLUM NECKSNAPPER

THIS MODEL IS SUPPLIED WITH A PLASTIC BOAR SPRUE AS STANDARD



EXAMPLE OF COMPLETED MORGLUM NECKSNAPPER

THE COMPLETE MORGLUM NECKSNAPPER CONSISTS OF:

- 1 x HEAD
- 1 x BODY
- 1 x LEFT ARM
- 1 x RIGHT ARM
- 1 x BANNER POLES
- 1 x BOAR HEAD
- 1 x PLASTIC BOAR SPRUE



HEAD
75241/2



BODY
75241/1



BANNER POLES
75241/5



BOAR HEAD
75241/6



RIGHT ARM
75241/4



LEFT ARM
75241/3

Designed by Alan Perry

UNDEAD

MOUNTED NECROMANCER

THIS MODEL IS SUPPLIED WITH A CAPARISONED HORSE SPRUE AS STANDARD



EXAMPLE OF COMPLETED MOUNTED NECROMANCER

THE COMPLETE MOUNTED NECROMANCER CONSISTS OF:

- 1 x TORSO
- 1 x LEGS
- 1 x CAPARISONED HORSE SPRUE



TORSO
74524/1



LEGS
74524/2

Designed by Gary Morley



ORCS

BLACK ORC COMMAND



BLACK ORC BOSS
75260/2



BLACK ORC DRUMMER
75260/5



BLACK ORC BANNER BEARER
75260/3



BLACK ORC BIG BOSS
75260/1



BANNER TOP
75260/4

THE COMPLETE BLACK ORC
BANNER BEARER CONSISTS OF:
1 x BLACK ORC BANNER BEARER
1 x BANNER TOP

BLACK ORCS



BLACK ORC WITH AXE 1
75255/4



BLACK ORC WITH AXE 2
75255/5



BLACK ORC WITH AXE 3
75255/6



**BLACK ORC WITH
AXE AND CLEAVER 1**
75255/3



**BLACK ORC WITH
AXE AND CLEAVER 2**
75255/2



**BLACK ORC WITH
AXE AND SWORD**
75255/1

SAVAGE ORCS

COMMAND

THESE FIGURES ARE SUPPLIED WITH A PLASTIC BOAR SPRUE AND THE APPROPRIATE PLASTIC SHIELDS AS STANDARD

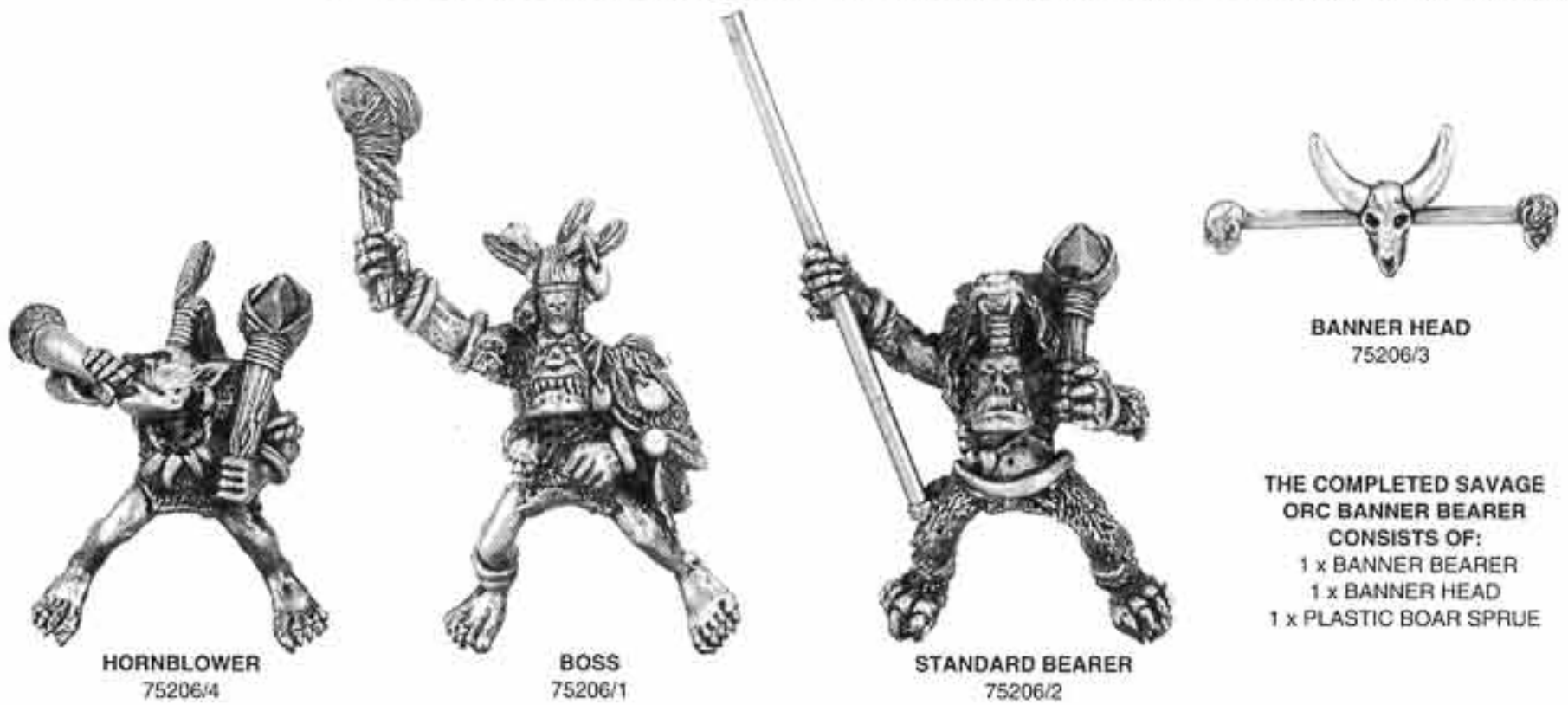

BOARBOYZ

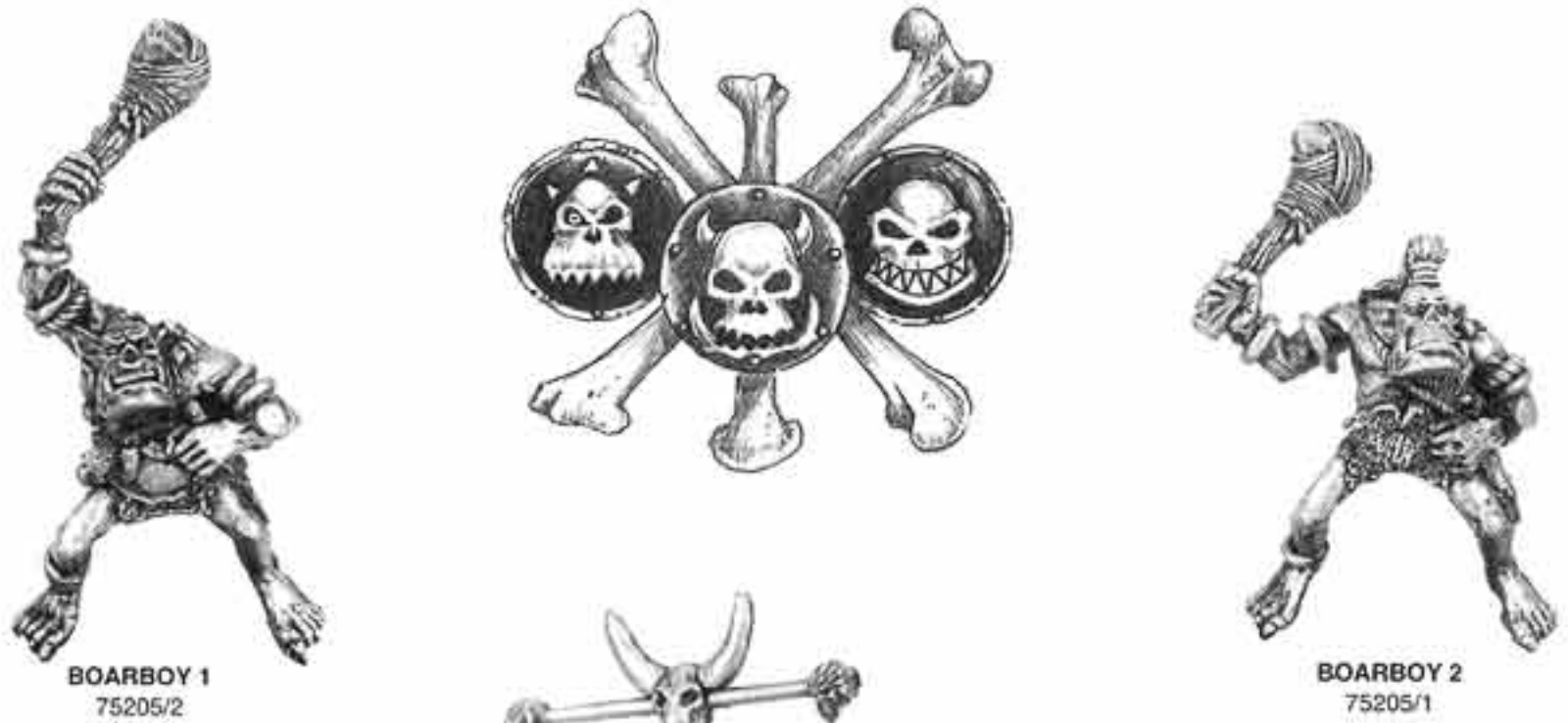

EXAMPLES OF COMPLETED SAVAGE ORC BOARBOYZ

Designed by Alan Perry

NIGHT GOBLINS

FANATICS



NIGHT GOBLIN
BALL AND CHAIN
FANATIC 1
075420/1



NIGHT GOBLIN
BALL AND CHAIN
FANATIC 2
075420/2



NIGHT GOBLIN
BALL AND CHAIN
FANATIC 3
075420/3



NIGHT GOBLIN
BALL AND CHAIN
FANATIC 4
075420/4



NIGHT GOBLIN
BALL AND CHAIN
FANATIC 5
075420/5



NIGHT GOBLIN
BALL AND CHAIN
FANATIC 6
075420/6

CLUBBERS



CLUBBER 1
075457/3



CLUBBER 2
075457/4



CLUBBER 3
75457/6



CLUBBER 4
75457/5

NETTERS



NETTER 1
074557/1



NETTER 2
074557/2



NETTER 3
074557/8



NETTER 4
074557/7

NIGHT GOBLINS

SKARSNIK AND GOBBLA



GOBBLA
75425/2



SKARSNIK
75425/1

SQUIG HOPPERS



NIGHT GOBLIN
SQUIG HOPPER 4
75440/4



NIGHT GOBLIN
SQUIG HOPPER 3
75440/3



NIGHT GOBLIN
SQUIG HOPPER 2
75440/2



NIGHT GOBLIN
SQUIG HOPPER 1
75440/1

CAVE SQUIGS AND HUNTERS



CAVE SQUIG 1
075469/2



CAVE SQUIG 2
075469/3



CAVE SQUIG 3
075469/4



NIGHT GOBLIN
SQUIG HUNTERS 2
075469/5



CAVE SQUIG 4
075469/6



CAVE SQUIG 5
075469/7



CAVE SQUIG 6
075469/8



CAVE SQUIG 7
075469/9



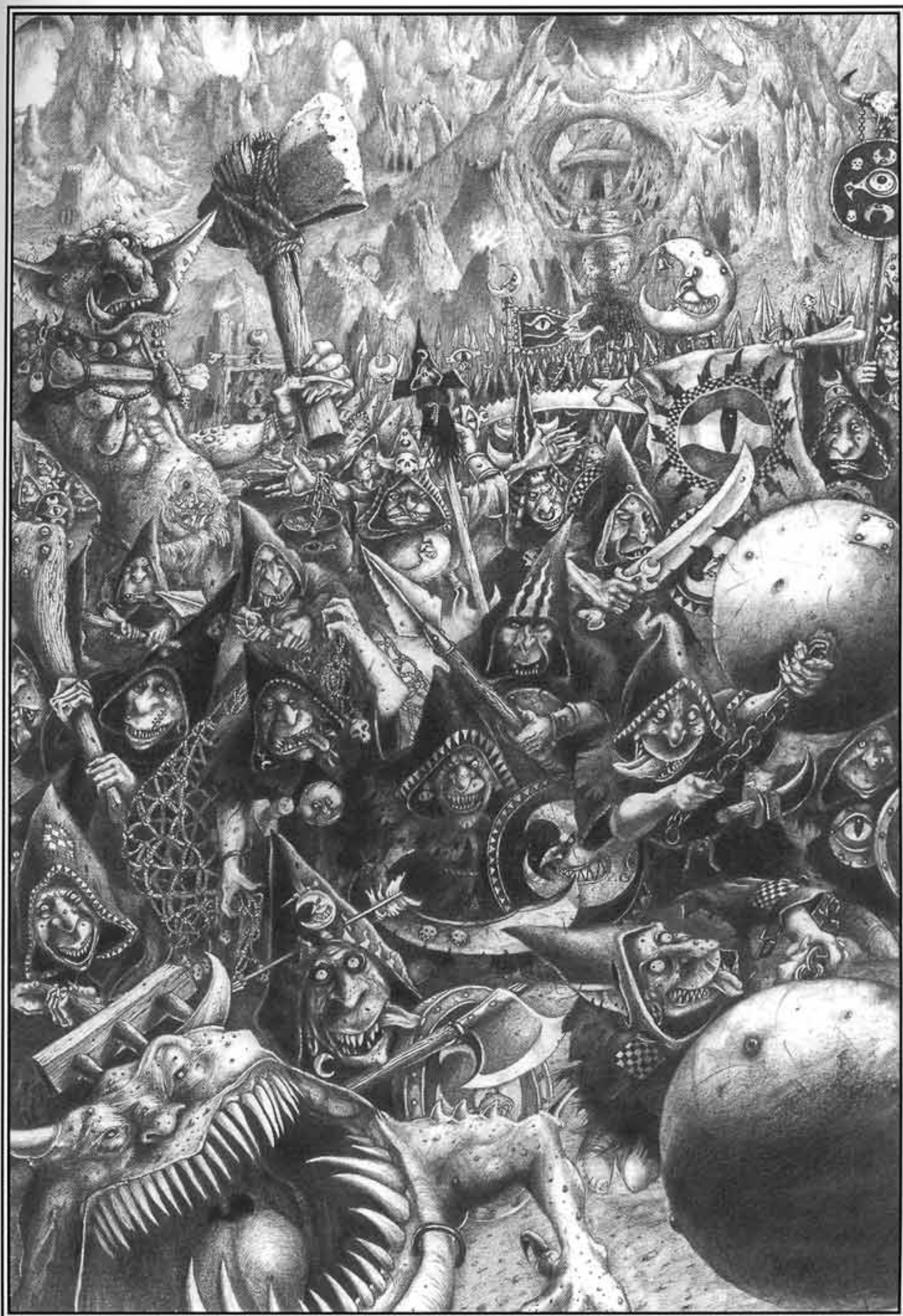

CHAOS DWARFS

COMMAND

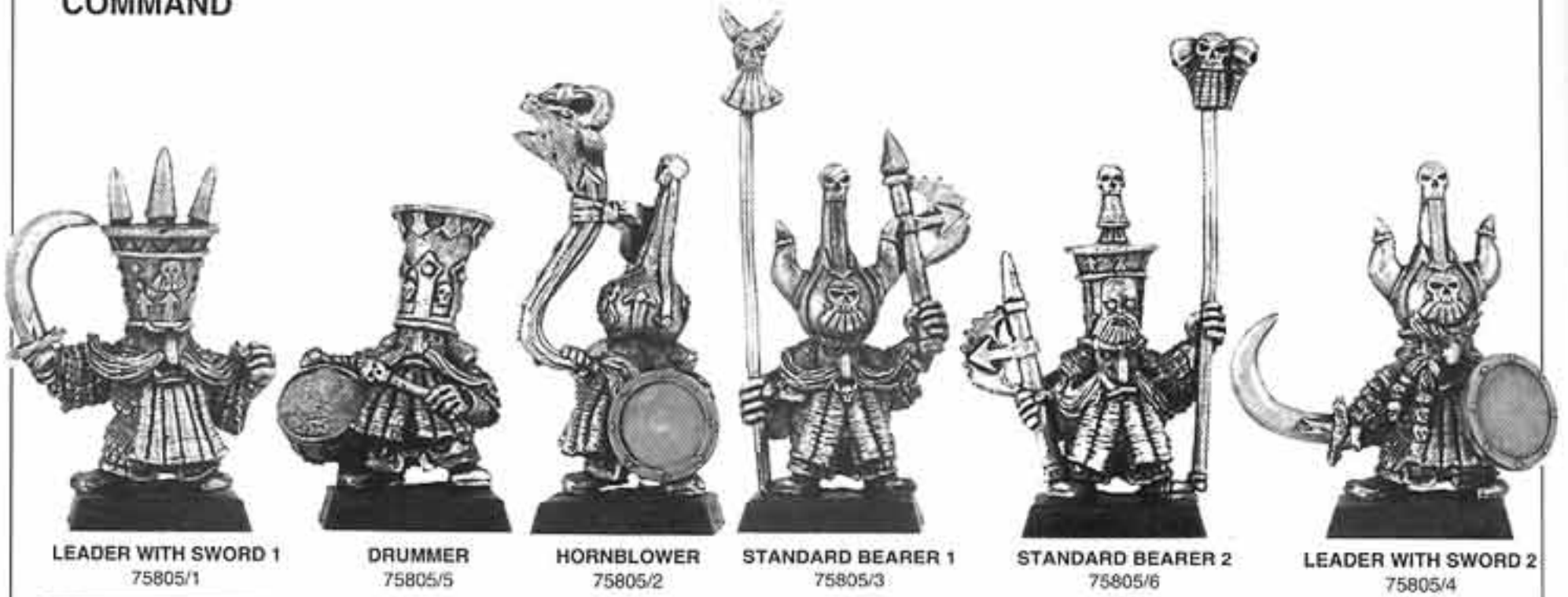

AXEMEN

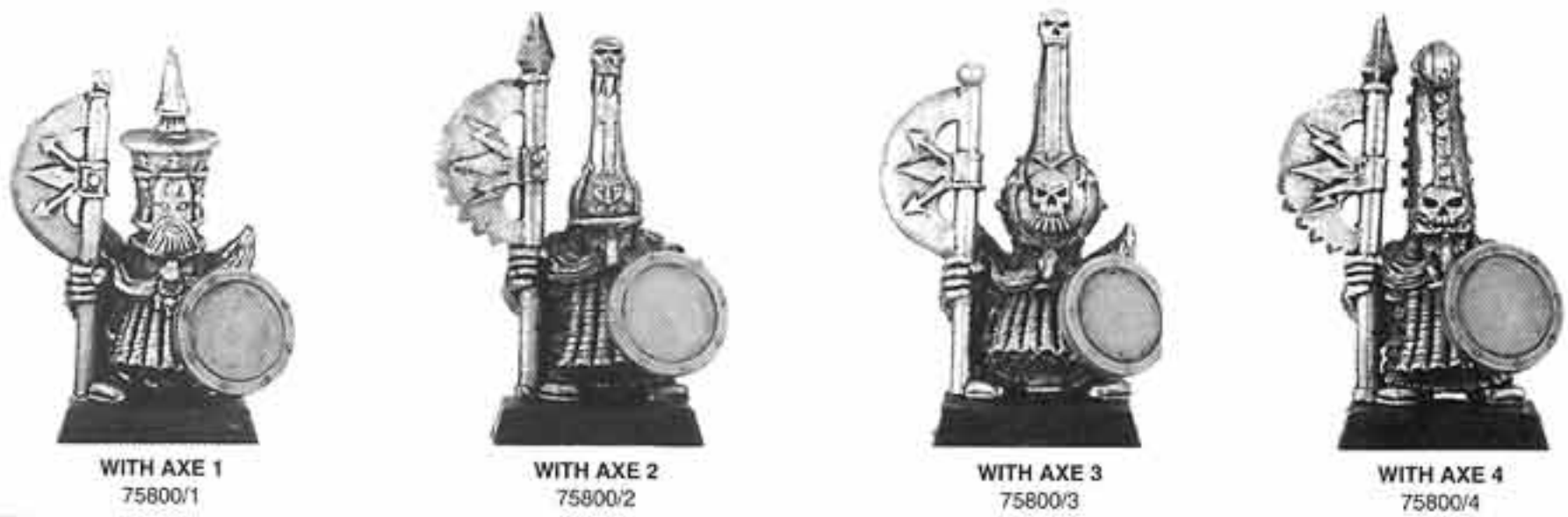

BLUNDERBUSSES



© Copyright Games Workshop Ltd 1994. All rights reserved.



Designed by Alan Perry

CHAOS DWARFS

CHAOS DWARF SORCERER ON LAMMASU



THE COMPLETE CHAOS DWARF SORCERER ON LAMMASU CONSISTS OF:

- 1 x SORCERER'S BACKBANNER
- 1 x SORCERER
- 1 x LAMMASU'S RIGHT TORSO
- 1 x LAMMASU'S LEFT TORSO
- 1 x LAMMASU'S HEAD
- 1 x RIGHT WING
- 1 x LEFT WING



SORCERER'S BACK BANNER
0838/2



CHAOS DWARF SORCERER
0838/1

EXAMPLE OF COMPLETED CHAOS DWARF SORCERER ON LAMMASU



LAMMASU'S LEFT BODY
0838/5



LAMMASU'S RIGHT BODY
0838/4



LEFT WING
0838/6

RIGHT WING
0838/7



LAMMASU'S HEAD
0838/3



© Copyright Games Workshop Ltd 1984. All rights reserved.



HOBGOBLINS

COMMAND

THESE MINIATURES ARE SUPPLIED WITH APPROPRIATE PLASTIC SHIELDS AS STANDARD



HOBGOBLIN
BIG BOSS 1
75860/4



HOBGOBLIN
BOSS 1
75860/3



HOBGOBLIN
DRUMER
75860/2



HOBGOBLIN
STANDARD BEARER 1
75860/1



HOBGOBLIN
BIG BOSS 2
75860/8



HOBGOBLIN
STANDARD BEARER 2
75860/5



HOBGOBLIN
BOSS 2
75860/7



HOBGOBLIN
TRUMPETER
75860/6

SNEAKY GITS



SNEAKY GIT 1
75873/1



SNEAKY GIT 2
75873/2



SNEAKY GIT 3
75873/3

Designed by Alan Perry

HOBGOBLINS

HOBGOBLIN BOLT THROWER

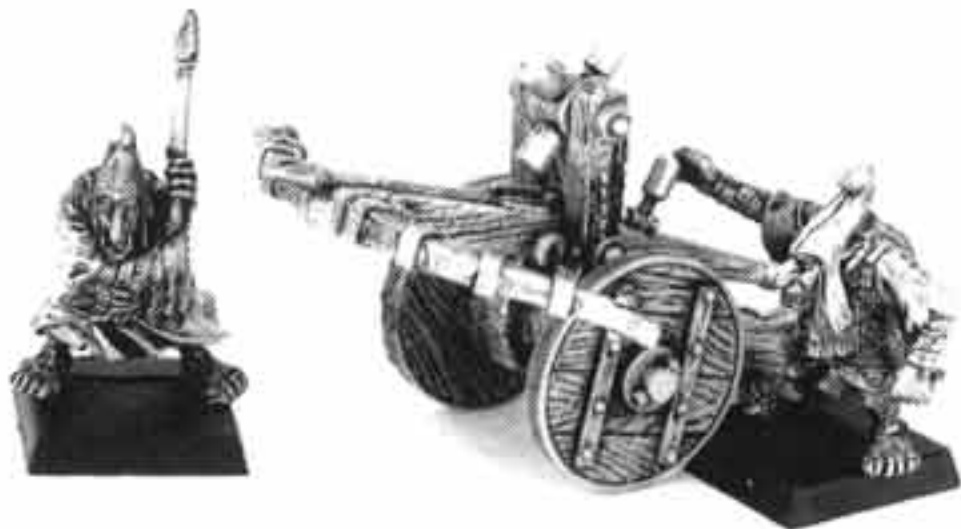

THE COMPLETED HOBGOBLIN BOLT THROWER CONSISTS OF:
 1 x HOBGOBLIN BOLT FIRER
 1 x HOBGOBLIN SPEAR LOADER
 1 x RIGHT SIDE
 1 x LEFT SIDE
 1 x BOLT THROWER
 1 x BOW
 1 x TOWING RING
 1 x WINDLASS
 2 x SOLID PLASTIC WHEELS

EXAMPLE OF COMPLETED HOBGOBLIN BOLT THROWER



RIGHT SIDE
75874/3



LEFT SIDE
75874/4



SOLID PLASTIC WHEEL



BOW
75874/6



BOLT THROWER
75874/5



TOWING RING
75874/7



WINDLASS
75874/8



HOBGOBLIN SPEAR LOADER
75874/2



HOBGOBLIN BOLT FIRER
75874/1

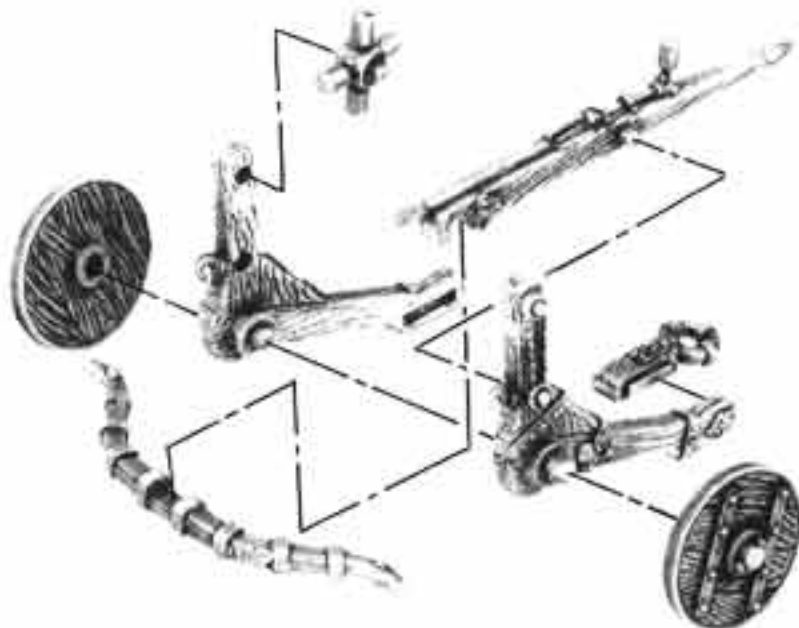

© Copyright Games Workshop Ltd 1993. All rights reserved.

ADEL
ARTIFICES

HIGH ELVES

PRINCE IMRIK LORD OF THE DRAGONS

THE COMPLETE HIGH ELF DRAGON RIDER

CONSISTS OF:

- 1 x DRAGON HEAD
- 1 x DRAGON HORNS
- 1 x DRAGON NECK
- 1 x DRAGON BODY
- 1 x DRAGON TAIL
- 1 x DRAGON LEFT ARM
- 1 x DRAGON RIGHT ARM
- 1 x DRAGON LEFT LEG
- 1 x DRAGON RIGHT LEG
- 1 x DRAGON LEFT WING
- 1 x DRAGON RIGHT WING
- 1 x PRINCE IMRIK
- 1 x PRINCE IMRIK'S BACK BANNER
- 1 x STARBLADE LANCE



EXAMPLE OF COMPLETED PRINCE IMRIK LORD OF THE DRAGONS

NECK
0527/3



BODY
0527/4



HORNS
0527/2



TAIL
0527/5



HEAD
0527/1

HIGH ELVES

PRINCE IMRIK
LORD OF THE DRAGONS



LEFT LEG
0527/9



RIGHT LEG
0527/8



LEFT ARM
0527/7



RIGHT ARM
0527/6



PRINCE IMRIK
0527/12

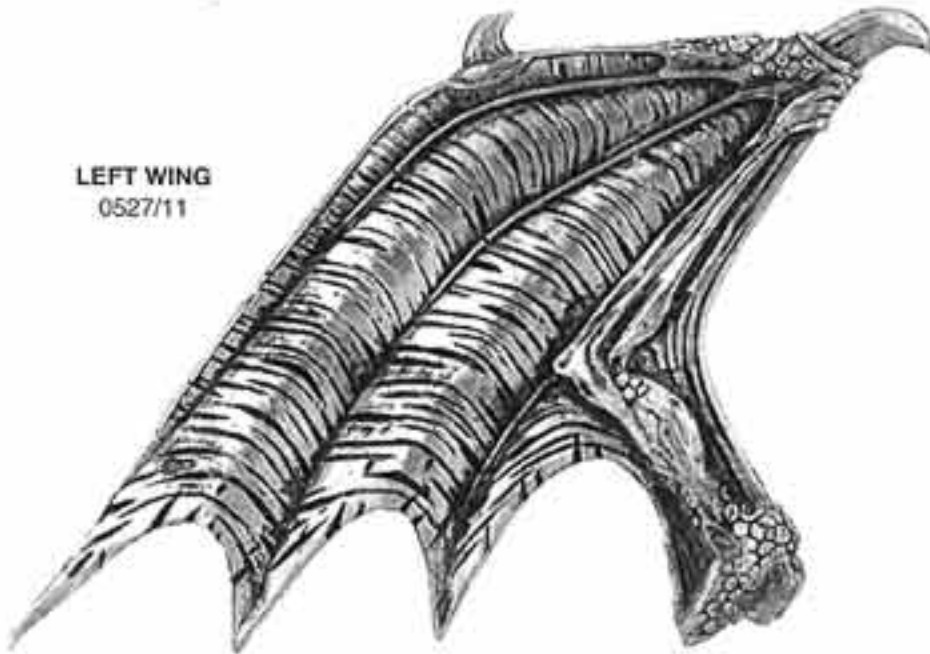

LEFT WING
0527/11

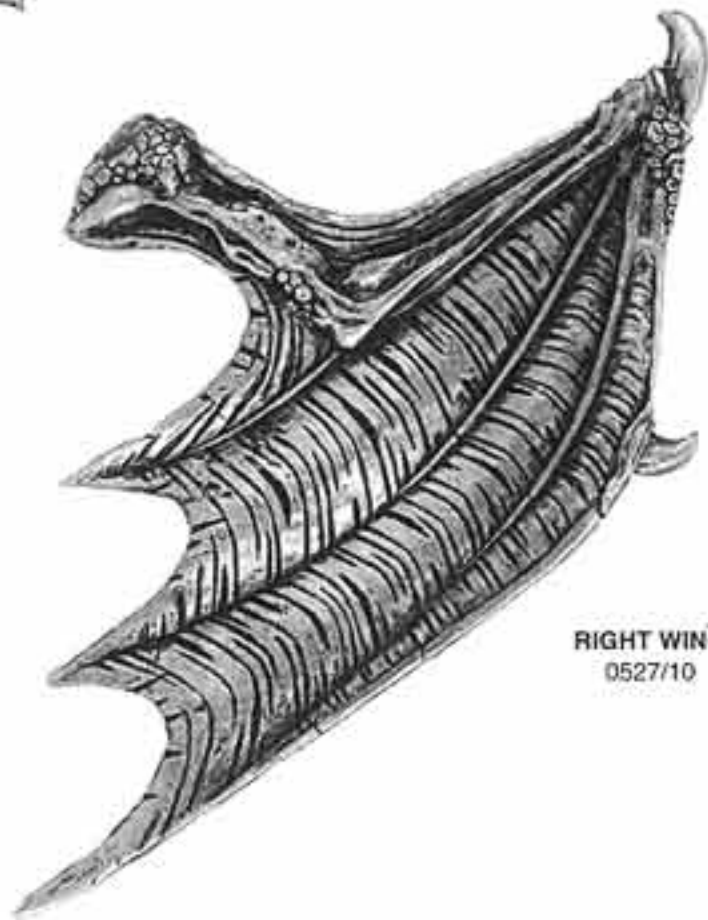

RIGHT WING
0527/10



STARBLADE LANCE
0527/13



PRINCE IMRIK'S
BACK BANNER
0527/14

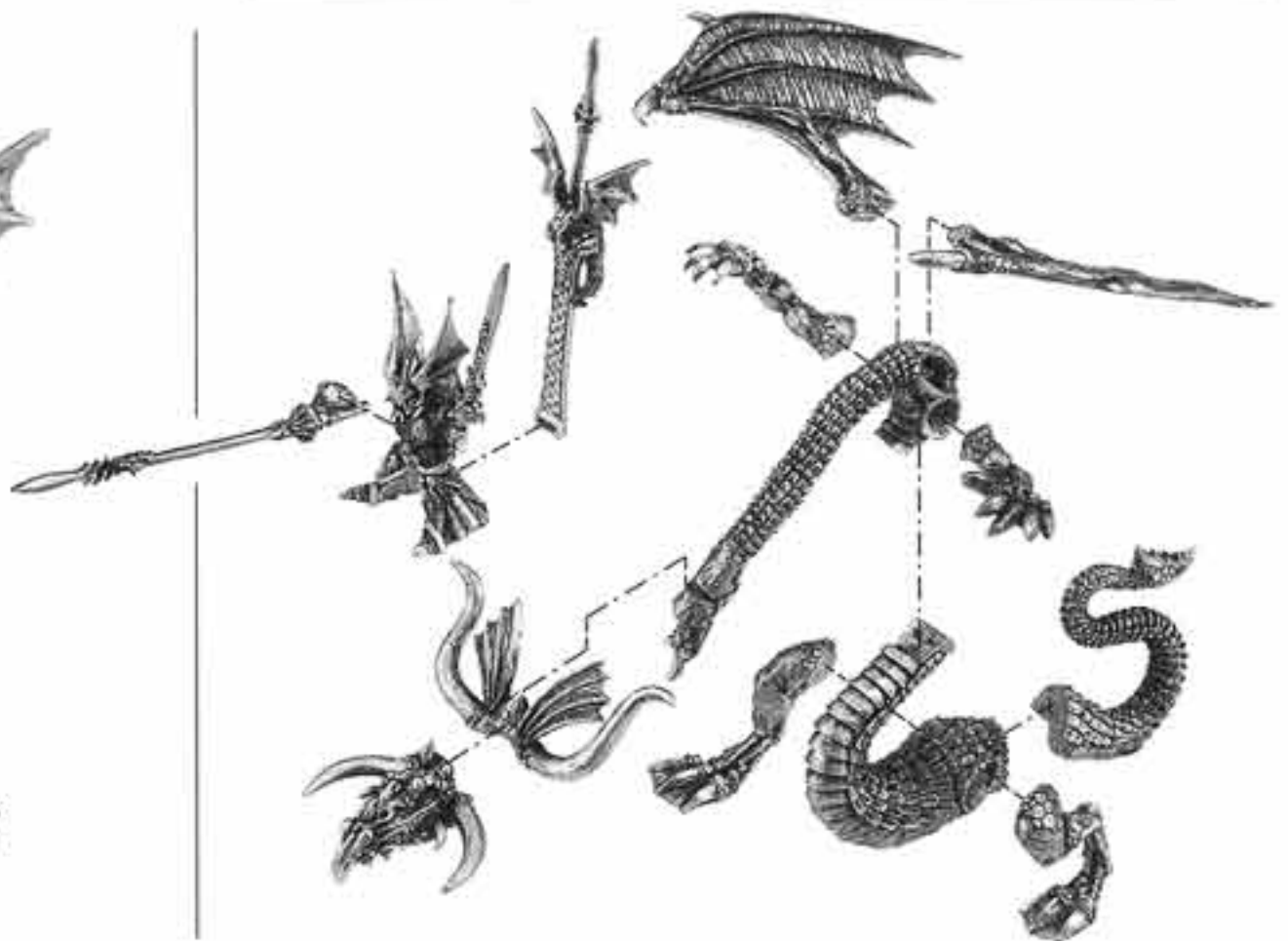

© Copyright Games Workshop Ltd 1988. All rights reserved.

ADEL
STATUES

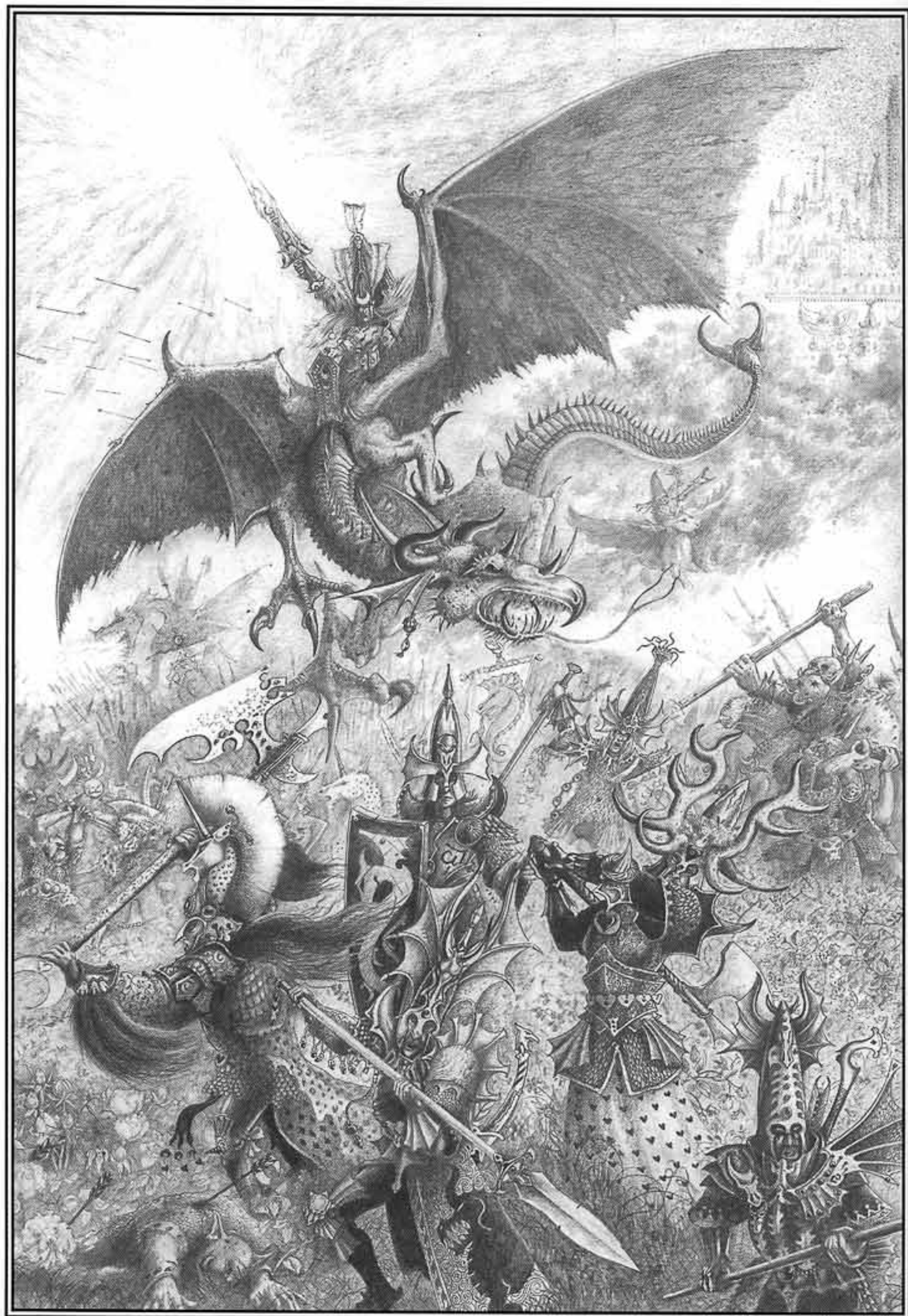

HIGH ELVES

DRAGON PRINCES OF CALEDOR



DRAGON PRINCE 1
0841/4



STANDARD BEARER
75675/4



HERO WITH SWORD
75675/5



DRAGON PRINCE 2
0841/5



DRAGON PRINCE 3
0841/6



DRAGON PRINCE
HORSE HEAD 1
0841/2



DRAGON PRINCE
HORSE HEAD 2
0841/3



DRAGON PRINCE
LEGS
0841/1



EXAMPLES OF COMPLETED DRAGON PRINCES OF CALEDOR

THESE MINIATURES ARE SUPPLIED WITH THE APPROPRIATE PLASTIC SHIELDS AND PLASTIC ARMoured HORSES AS STANDARD

HIGH ELVES

HIGH ELF COMMAND GROUP



HIGH ELF HERO
WITH SWORD AND BOW 1
075613/4



HIGH ELF HERO
WITH SWORD AND SHIELD 1
075613/3



HIGH ELF
STANDARD BEARER 1
075613/1



HIGH ELF
TRUMPETER 1
075613/2

HIGH ELF WARRIORS



HIGH ELF
ARCHER 1
075625/1



HIGH ELF
ARCHER 2
075625/2



HIGH ELF
ARCHER 3
075625/3



HIGH ELF
ARCHER 4
075625/4



HIGH ELF
SPEARMAN 1
075600/1



HIGH ELF
SPEARMAN 2
075600/2



HIGH ELF
SPEARMAN 3
075600/3



HIGH ELF
ARCHER 5
075625/5

THESE MINIATURES ARE SUPPLIED WITH THE APPROPRIATE PLASTIC SHIELDS AS STANDARD

Designed by Jes Goodwin

HIGH ELVES

HIGH ELF COMMAND GROUP



HIGH ELF HERO
SWORD AND BOW 2
75613/8



HIGH ELF
TRUMPETER 2
75613/6



HIGH ELF
STANDARD BEARER 2
75613/5



HIGH ELF HERO
WITH SPEAR
75613/7

THESE MINIATURES ARE SUPPLIED WITH THE APPROPRIATE PLASTIC SHIELDS AS STANDARD

HIGH ELF REPEATER BOLT THROWER

THE COMPLETE HIGH ELF BOLT THROWER
CONSISTS OF:

- 1 X UPPER BOW
- 1 X LOWER BOW
- 2 X HIGH ELF CREWMAN
- 1 X BOLT THROWER STAND
- 1 X BOLT THROWER LEVER



BOLT THROWER
UPPER BOW
075649/4



BOLT THROWER
LEVER
075649/6



THE ASSEMBLED BOLT THROWER MODEL



BOLT THROWER
LOWER BOW
075649/3



BOLT THROWER
STAND
075649/5



HIGH ELF
CREW 1
075649/1



HIGH ELF
CREW 2
075649/2

WOOD ELVES

WOOD ELF ARCHES



BOW 1
RR4/EA



BOW 2
RR4/HA



BOW 3
RR4/GA



BOW 4
RR4/GB



BOW 5
RR4/FA



BOW 6
RR4/FB



BOW 7
RR4/EB



BOW 8
RR4/HB



BOW 9
074213/10



BOW 10
074213/11



BOW 11
074213/7



BOW 12
074213/25



BOW 13
074213/9



BOW 14
074213/6



BOW 15
074213/23



BOW 16
074213/40

THESE MODELS ARE SUPPLIED WITH AN ELF SHIELDS SPRUE AS STANDARD

Designed by Jes Goodwin

WOOD ELVES

WOOD ELF WAR DANCES



DOUBLE HANDED SWORD 1
074237/14



SWORD 6
074237/19



SWORDS 2
074237/17



SWORD 1
074237/7



SPEAR 1
074237/24



SPEAR 2
074237/23



DOUBLE HANDED AXE 1
074237/30



DOUBLE HANDED SWORD 2
074237/2

Designed by Jes Goodwin

TREEMAN A



TREEMAN BODY A
MM48/1



TREEMAN A
RIGHT ARM
MM48/2



TREEMAN A
LEFT ARM
MM48/3

THE COMPLETE
MARAUDER TREEMAN A
CONSISTS OF:
1 x TREEMAN BODY
1 x TREEMAN LEFT ARM
1 x TREEMAN RIGHT ARM



TREEMAN B



TREEMAN BODY B
MM48/4



TREEMAN B
RIGHT ARM
MM48/6



TREEMAN B
LEFT ARM
MM48/5

THE COMPLETE
MARAUDER TREEMAN B
CONSISTS OF:
1 x TREEMAN BODY
1 x TREEMAN LEFT ARM
1 x TREEMAN RIGHT ARM



Designed by Trish Morrison

EMPIRE

KISLEV HORSE ARCHERS



HORSE ARCHER 1
073749/7



HORSE ARCHER 2
073749/8



HORSE ARCHER 3
073749/10



HORSE ARCHER 4
073749/11



HORSE ARCHER
CHIEFTAIN
073749/1



HORSE ARCHER
STANDARD BEARER
073749/3



HORSE ARCHER
HORN MUSICIAN
073749/2



HORSE ARCHER
WITH SWORD 1
073749/9



HORSE ARCHER'S
LEGS 1
073749/12



HORSE ARCHER'S
LEGS 2
073749/4



HORSE ARCHER'S
LEGS 3
073749/5



HORSE ARCHER
WITH SWORD 2
073749/6

EXAMPLE OF COMPLETED KISLEV HORSE ARCHERS



THESE MINIATURES ARE SUPPLIED WITH PLASTIC UNARMoured HORSES AS STANDARD

© Copyright Games Workshop Ltd 1992. All rights reserved.



CITADEL
MINIATURES

Designed by Alan Perry

EMPIRE

REIKSGUARD KNIGHTS



REIKSGUARD KNIGHT 1
073788/1



REIKSGUARD KNIGHT 2
073788/2



REIKSGUARD
KNIGHT'S LEGS
073788/3

EXAMPLE OF A COMPLETED REIKSGUARD KNIGHT

Designed by Michael Perry

KNIGHTS OF THE BLAZING SUN



EXAMPLE OF A COMPLETED KNIGHT OF THE BLAZING SUN



BLAZING SUN KNIGHT 1
073713/1



BLAZING SUN KNIGHT 2
073713/2



KNIGHT OF THE BLAZING SUN
STANDARD BEARER
073713/3



KNIGHT'S LEGS
073764/3



GRAND MASTER OF THE
KNIGHTS OF THE BLAZING SUN
073713/4

THESE MINIATURES ARE SUPPLIED WITH PLASTIC ARMoured HORSES AND THE APPROPRIATE PLASTIC SHIELD AS STANDARD

Designed by Alan Perry

EMPIRE

ELECTOR COUNTS



EXAMPLE OF A COMPLETED ELECTOR COUNT



ELECTOR COUNT
OF HOCHLAND
0821/3



ELECTOR COUNT
OF MIDDENHEIM
0821/4



ELECTOR COUNT
OF AVERLAND
0821/2



ELECTOR COUNT
OF OSTLAND
0821/1

HEROES OF THE EMPIRE



EXAMPLE OF A COMPLETED HERO OF THE EMPIRE



LUDWIG SCHWARZHELM
THE EMPEROR'S CHAMPION
0820/2



IMPERIAL HERALD WITH
BATTLE STANDARD
0820/4



SUPREME PATRIARCH OF THE
COLLEGES OF MAGIC
0820/3



CAPTAIN OF THE
REIKSGUARD
0820/1

THESE MINIATURES ARE SUPPLIED WITH PLASTIC ARMoured OR CAPARISON HORSES AS STANDARD

Designed by Michael Perry

EMPIRE

IMPERIAL WAR WAGON

**THE COMPLETE WAR WAGON
CONSISTS OF:**

- 1 x WAR WAGON HAFT
- 1 x WAR WAGON YOKE
- 2 x WAR WAGON SIDE PANELS
- 2 x FRONT/REAR PANELS
- 2 x FRONT/REAR FRAMES
- 4 x PLASTIC WHEELS
- 2 x ARMORED HORSES
- 1 x CREWMAN WITH MANCATCHER
- 1 x CREWMAN WITH HOOK HALBERD
- 1 x CREWMAN WITH BALL AND CHAIN
- 1 x CREWMAN WITH HOCHLAND LONG RIFLE
- 1 x CREWMAN WITH BLUNDERBUSS
- 1 x CREWMAN WITH REPEATING MUSKET
- 1 x WAR WAGON DECK

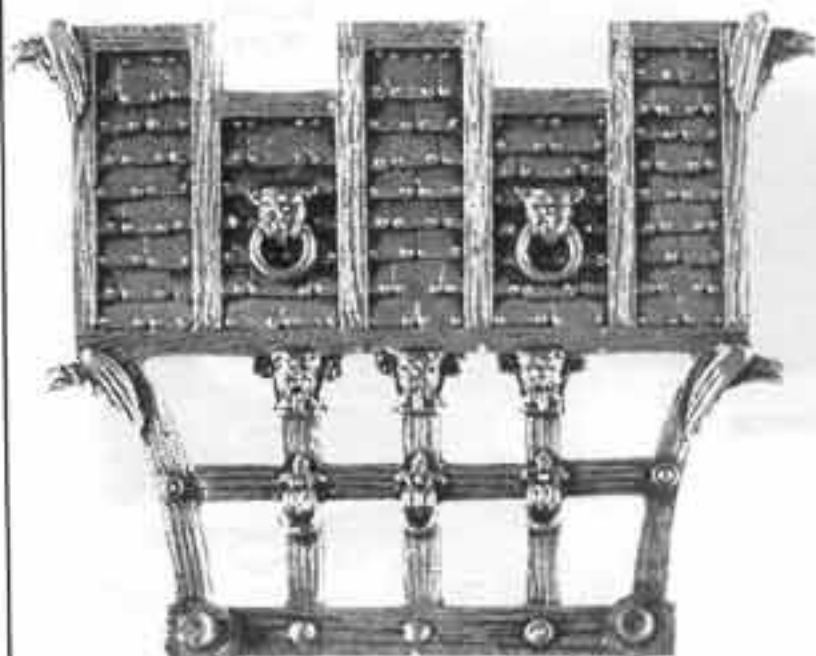

**WAR WAGON
RIGHT / LEFT SIDE PANELS**
00811/1



**WAR WAGON
FRONT / REAR PANELS**
00811/3



WAGON YOKE
00811/6



WAGON HAFT
00811/5

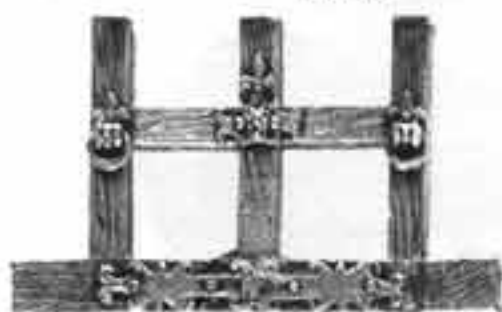

**WAR WAGON
FRONT / REAR FRAMES**
00811/4



WAGON DECK
00811/2



PLASTIC WHEEL

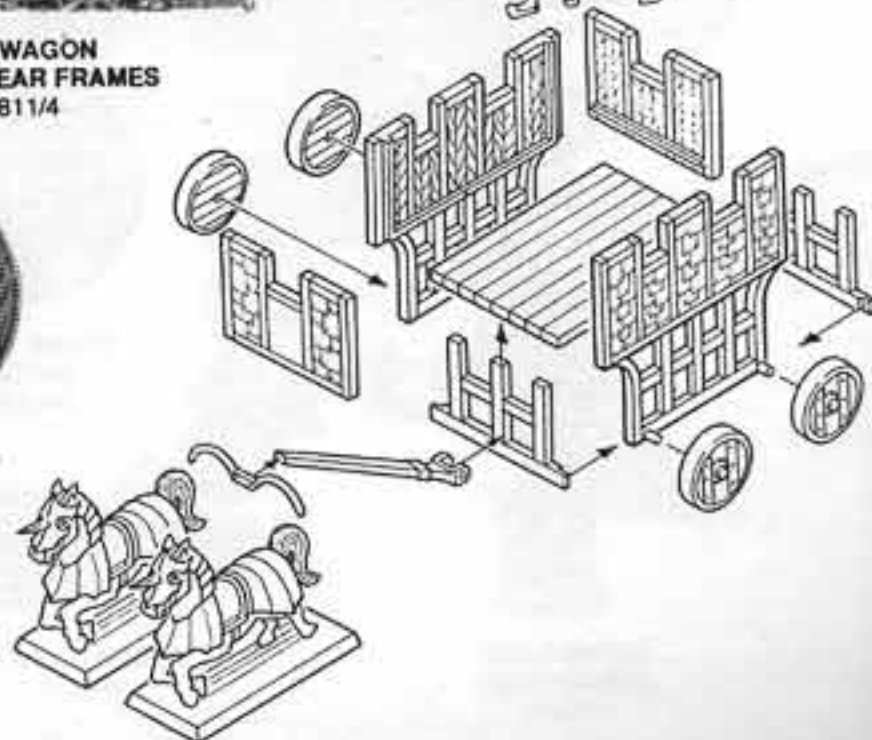

EMPIRE

IMPERIAL STEAM TANK



- THE COMPLETE IMPERIAL STEAM TANK
CONSISTS OF;
- 1 x COMMANDER
 - 4 x PLASTIC WHEELS
 - 1 x R/HAND SIDE ARMOUR
 - 1 x L/HAND SIDE ARMOUR
 - 1 x FRONT ARMOUR
 - 1 x STEAM CANNON
 - 1 x BACK PLATE
 - 1 x BOILER
 - 1 x ENGINE
 - 1 x HATCH
 - 1 x ROOF
 - 1 x BASE



STEAM TANK
BACK PLATE
0812/6



STEAM TANK
ENGINE
0812/7



FRONT ARMOUR
0812/9



STEAM TANK
BOILER
0812/8



L/HAND SIDE ARMOUR
0812/2



R/HAND SIDE ARMOUR
0812/3



STEAM TANK ROOF
0812/4

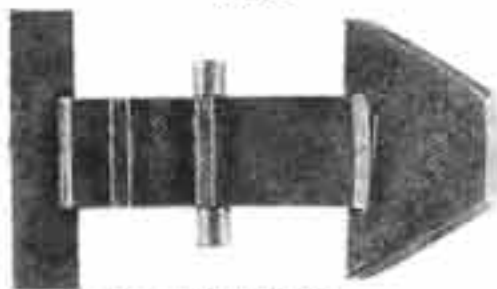

STEAM TANK BASE
0812/1



PLASTIC WHEEL



STEAM TANK
HATCH
0812/5



STEAM CANNON
0812/10



STEAM TANK
COMMANDER
0812/11

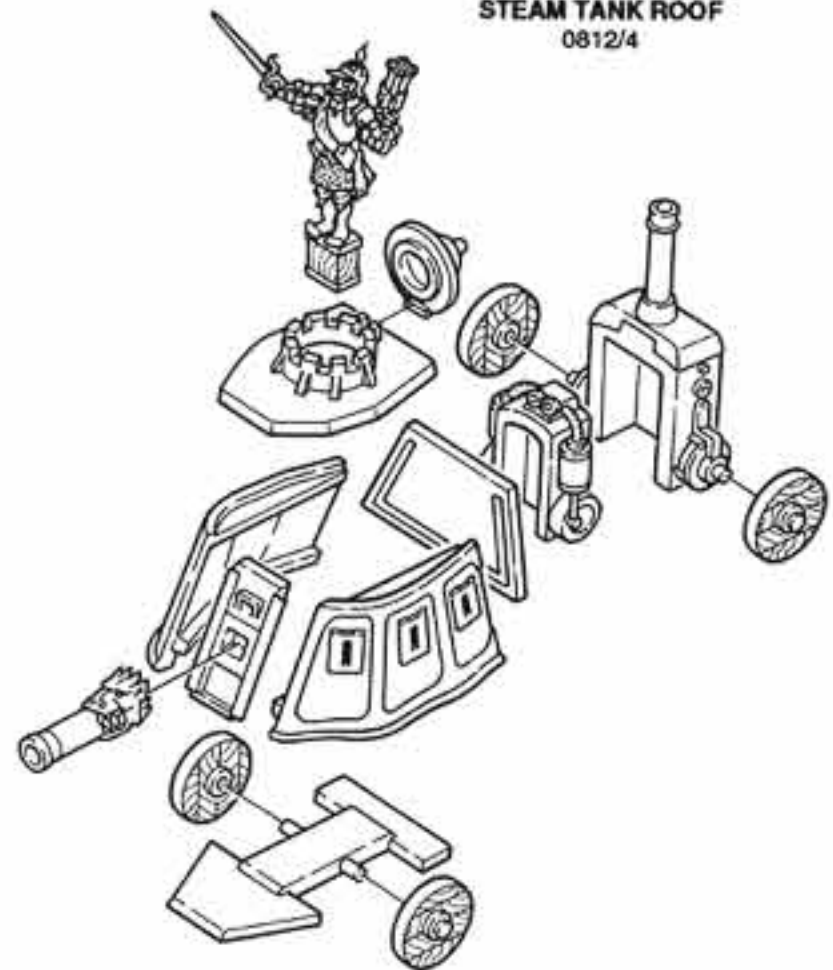

Miniatures supplied unpainted. WARNING: This product contains lead which may be harmful if chewed or swallowed. Citadel Miniatures are not recommended for children under 14 years of age. © Copyright Games Workshop Ltd 1992. All rights reserved.



DWARF SLAYERS

TROLL SLAYERS



TROLL SLAYER 1
88091/57



TROLL SLAYER 2
88091/51



TROLL SLAYER 3
88091/52

GIANT SLAYERS



GIANT SLAYER 1
88092/54



GIANT SLAYER 2
88092/53

DRAGON SLAYER



DRAGON SLAYER
88097/55

DAEMON SLAYER



DAEMON SLAYER
88098/98



ANVIL OF DOOM

DWARF RUNESMITH'S ANVIL OF DOOM

THE COMPLETE ANVIL OF DOOM
CONSISTS OF:
1 x RUNEPRIEST
2 x GUARDIAN
1 x ANVIL OF DOOM
1 x ANVIL PEDESTAL
1 x ANVIL BASE
2 x BANNER POLE
4 x PLASTIC SPOKED WHEELS



EXAMPLE OF COMPLETED DWARF RUNESMITH AND THE ANVIL OF DOOM



BANNER POLE
0836/6



ANVIL OF DOOM
0836/3



ANVIL BASE
0836/4



PLASTIC
SPOKED WHEELS
100557



ANVIL PEDESTAL
0836/5



RUNEPRIEST
0836/2



GUARDIAN
0836/1

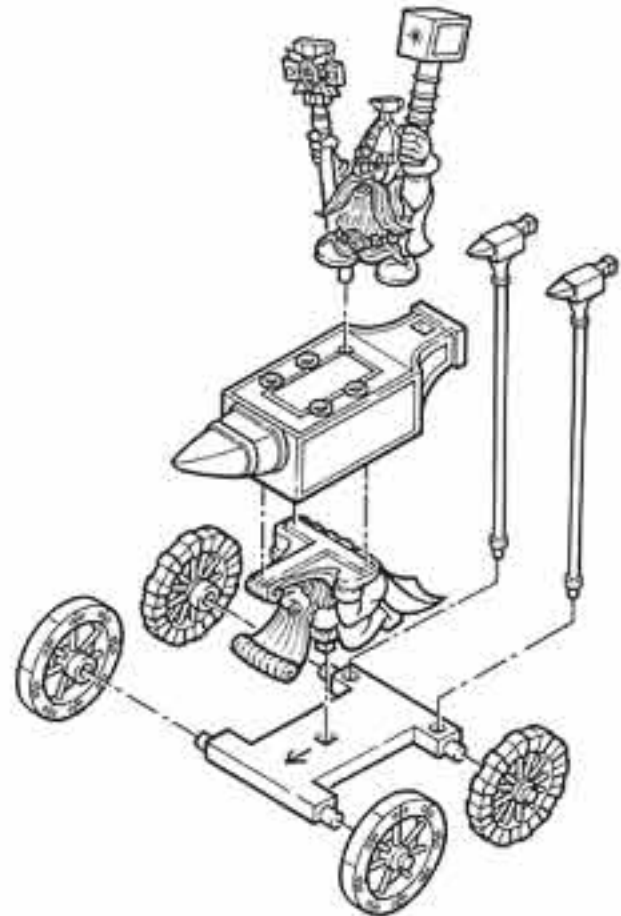

Miniatures supplied unpainted. WARNING: This product contains lead which may be harmful if swallowed. © Copyright Games Workshop Ltd 1993. All rights reserved.



FLAME CANNON

DWARF FLAME CANNON

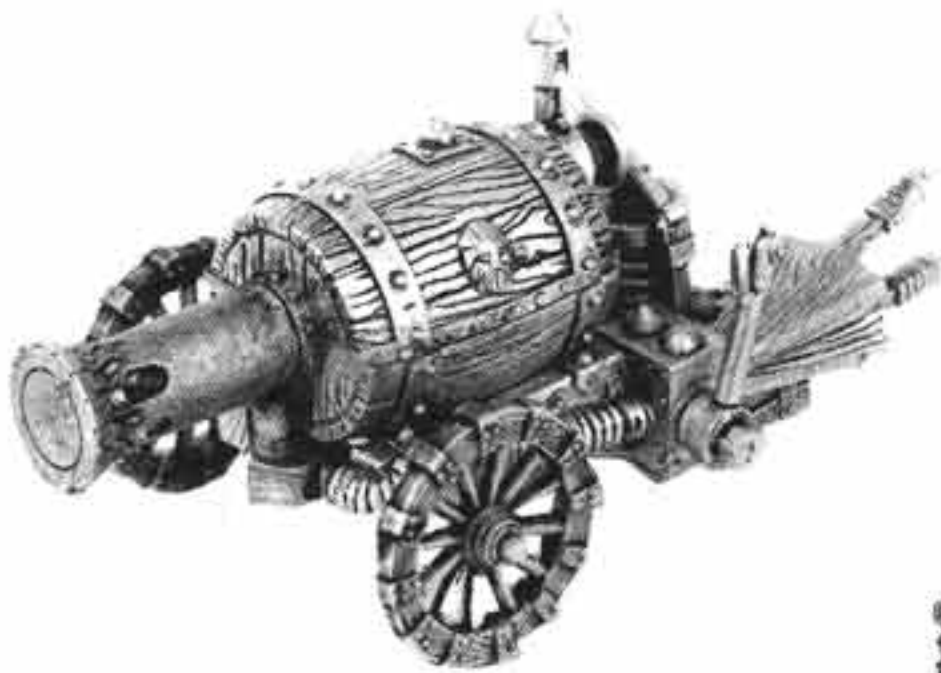

THE COMPLETE DWARF FLAME CANNON
CONSISTS OF:

- 3 x CREW
- 1 x CANNON
- 1 x UPPER BARREL
- 1 x LOWER BARREL
- 1 x LEVER
- 1 x BELLOWS
- 1 x PUMP
- 1 x STEAM WHISTLE
- 1 x INSTRUMENTS PANEL
- 1 x FRONT BASE
- 1 x REAR BASE
- 2 x PLASTIC SPOKED WHEELS

EXAMPLE OF COMPLETED DWARF FLAME CANNON



MASTER GUNNER
0837/1



LOADER
0837/2



SWABBER
0837/3



FRONT BASE
0837/7

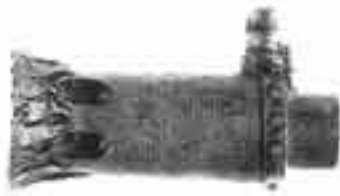

CANNON
0837/8



LEVER
0837/11



BELLOWS
0837/13

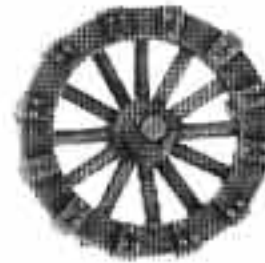

PLASTIC
SPOKED WHEELS
100557



REAR BASE
0837/6



UPPER BARREL
0837/5



PUMP
0837/10



STEAM WHISTLE
0837/12

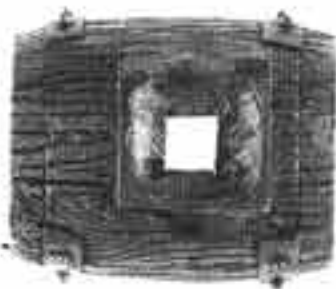
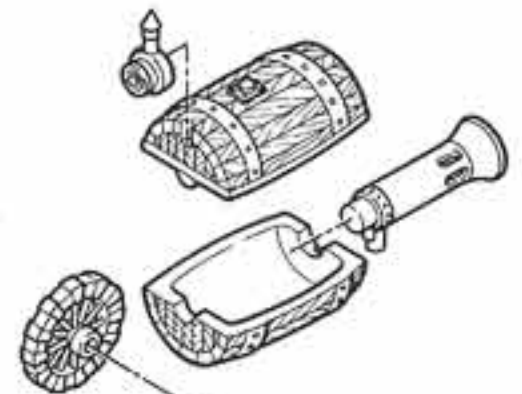

LOWER BARREL
0837/4



INSTRUMENTS PANEL
0837/9

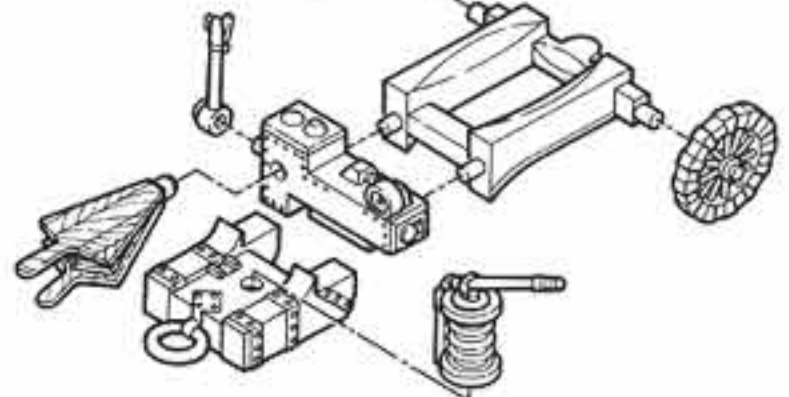

DWARFS

HAMMERERS



LONG BEARDS



IRON BREAKERS



Marauder Miniatures are supplied unpainted. Banners not included.

Designed by Aly Morrison and Colin Dixon

© Copyright Marauder Miniatures Ltd. 1993. All rights reserved.

Warning! These miniatures contain lead which may be harmful if chewed or swallowed. Marauder Miniatures are not recommended for children under 14 years of age.

EPIC SQUATS

SQUAT COLOSSUS

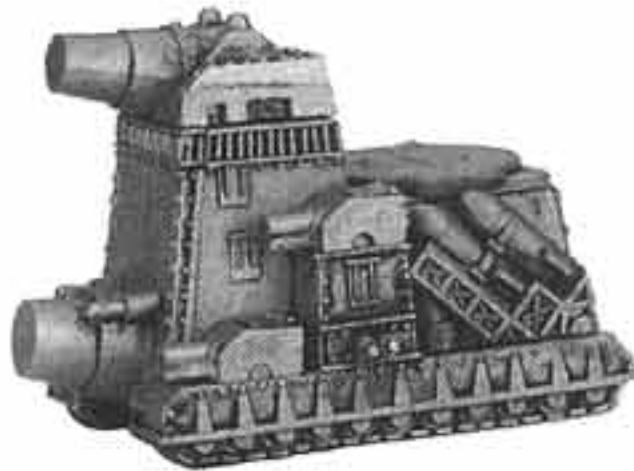

EXAMPLE OF A COMPLETED SQUAT COLOSSUS

THE COMPLETE SQUAT COLOSSUS CONSISTS OF:

- 1 x COLOSSUS THUNDERER CANNON
- 1 x COLOSSUS DOOMSDAY CANNON
- 4 x BATTLE CANNON TURRETS
- 1 x COLOSSUS RIGHT SIDE
- 1 x COLOSSUS LEFT SIDE
- 2 x MISSILE RACKS
- 1 x LANDING PAD
- 1 x IRON EAGLE GYROCOPTER
- 1 x PLASTIC FLYING STAND

MISSILE RACKS
76722/7



COLOSSUS THUNDERER CANNON
76722/4



MISSILE RACKS
76722/7



BATTLE CANNON TURRETS
76722/6



LANDING PAD
76722/5



COLOSSUS RIGHT SIDE
76722/2

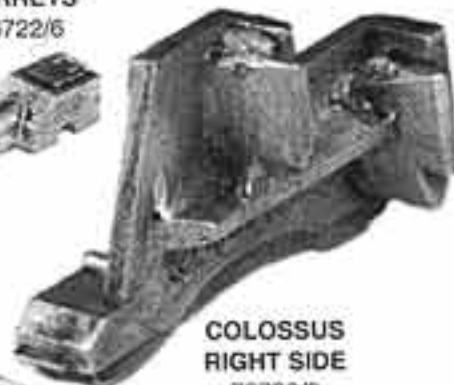

COLOSSUS LEFT SIDE
76722/1

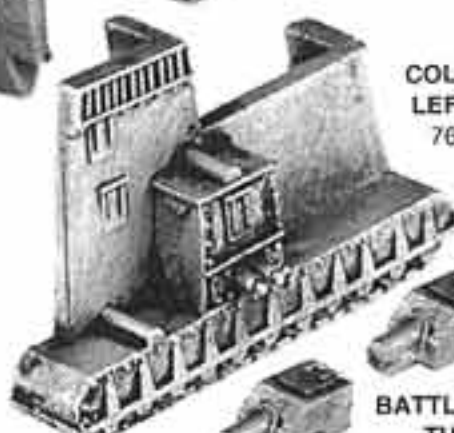

BATTLE CANNON TURRETS
76722/6



COLOSSUS DOOMSDAY CANNON
76722/3



GOLIATH MEGA CANNON

A COMPLETE GOLIATH MEGA CANNON CONSISTS OF:

- 1 x GOLIATH MEGA CANNON BARREL
- 1 x GOLIATH MEGA CANNON TRACK UNIT

GOLIATH MEGA CANNON BARREL
76734/2



EXAMPLE OF A COMPLETED GOLIATH MEGA CANNON

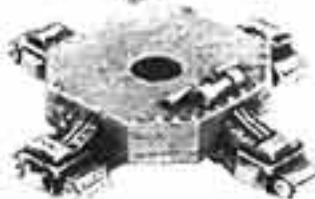

GOLIATH MEGA CANNON TRACK UNIT
76734/1

OVERLORD AIRSHIP

A COMPLETE OVERLORD AIRSHIP CONSISTS OF:

- 1 x OVERLORD AIRSHIP UPPER HALF
- 1 x OVERLORD AIRSHIP BOTTOM HALF
- 2 x OVERLORD AIRSHIP BATTLE CANNONS
- 1 x PLASTIC FLYING STAND



EXAMPLE OF A COMPLETED OVERLORD AIRSHIP

OVERLORD AIRSHIP UPPER HALF
076746/1



OVERLORD AIRSHIP LOWER HALF
076746/2

OVERLORD AIRSHIP BATTLE CANNONS
076746/3



OVERLORD AIRSHIP BATTLE CANNONS
076746/3

EPIC® IMPERIAL

BANEBLADE

A COMPLETE BANEBLADE
CONSISTS OF:
1 x BANEBLADE TURRET
1 x BANEBLADE CHASSIS
2 x SPONSON TURRETS 1



EXAMPLE OF A COMPLETED BANEBLADE

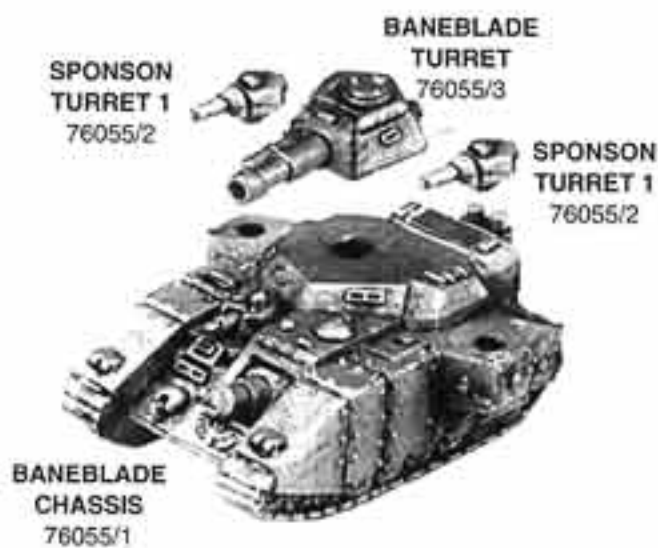

SHADOW SWORD

A COMPLETE SHADOW SWORD
CONSISTS OF:
1 x SHADOW SWORD CHASSIS
1 x VOLCANO CANNON
2 x SPONSON TURRETS 2



EXAMPLE OF A COMPLETED SHADOW SWORD

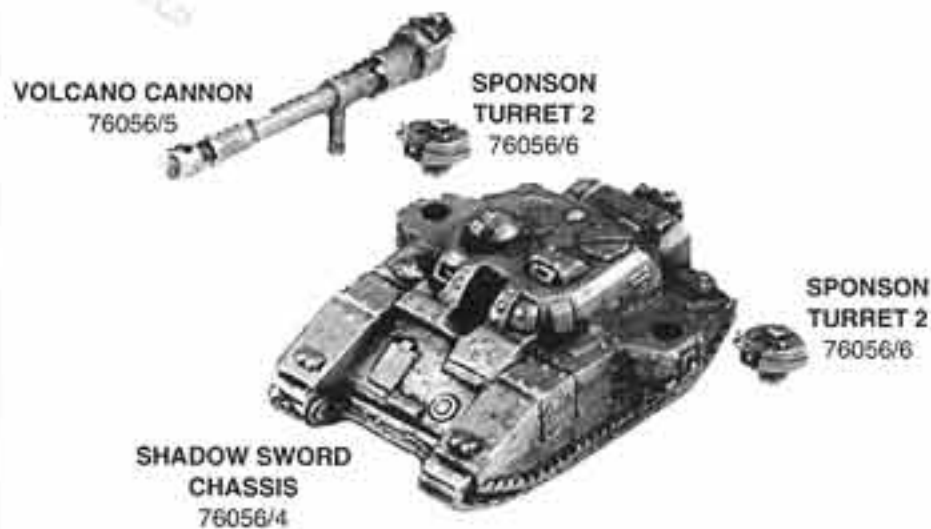

STORMHAMMER

THE COMPLETE STORMHAMMER CONSISTS OF
2 x STORMHAMMER TURRETS
4 x SPONSON TURRETS 2
1 x STORMHAMMER CHASSIS



EXAMPLE OF A COMPLETED STORMHAMMER

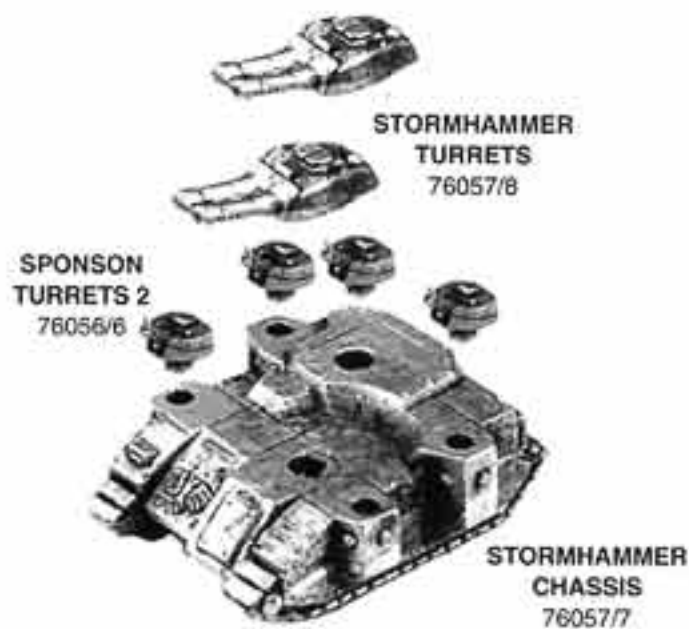

IMPERIAL MOLE

THE COMPLETE IMPERIAL MOLE CONSISTS OF
1 x MOLE
1 x TRANSPORTER
1 x LAUNCH RAMP
1 x HYDRAULIC PISTON



EXAMPLE OF A COMPLETED IMPERIAL MOLE

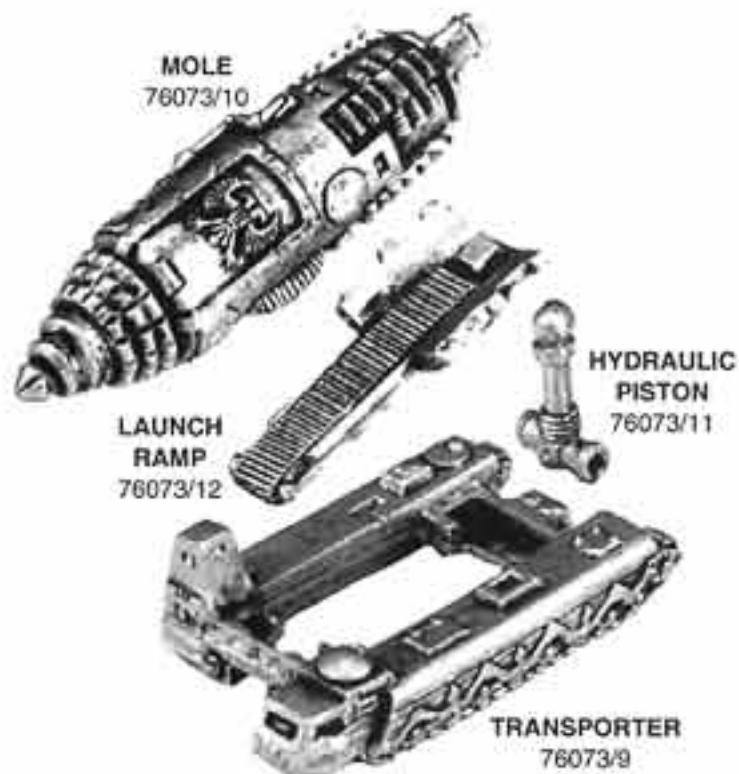

EPIC SQUAT

SQUAT CYCLOPS

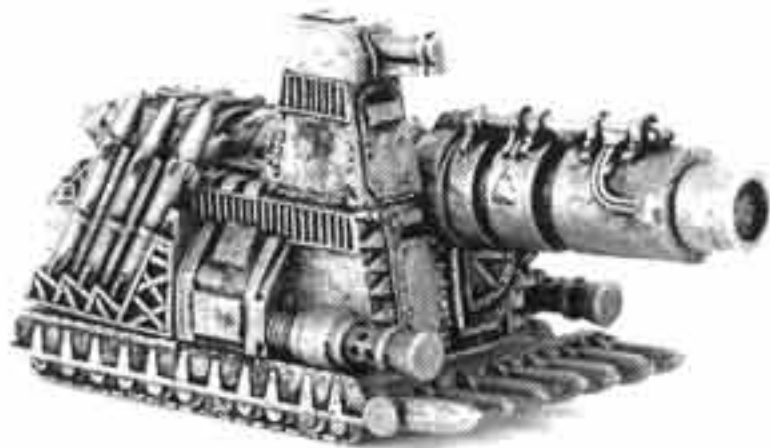

THE COMPLETED SQUAT CYCLOPS CONSISTS OF:

- 1 x HELLFURY CANNON BARREL
- 1 x HELLFURY CANNON END
- 1 x HELLFURY CANNON TOP
- 2 x DOOMSTORM MISSILES
- 1 x RAM
- 1 x BATTLE CANNON TURRET
- 2 x MELTA CANNON
- 1 x HULL LEFT SIDE
- 1 x HULL RIGHT SIDE
- 1 x HULL REAR
- 1 x BARREL SUPPORT

EXAMPLE OF COMPLETED SQUAT CYCLOPS

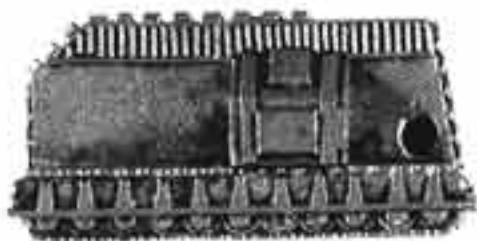

HULL RIGHT SIDE
0500/1

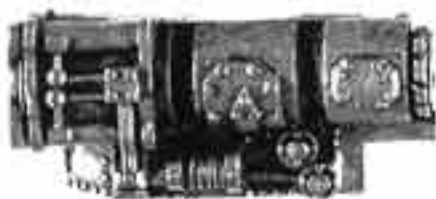

HELLFURY CANNON TOP
0500/3

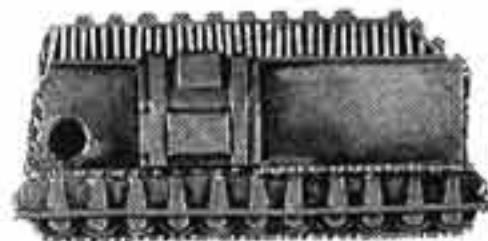

HULL LEFT SIDE
0500/2



HULL REAR
0500/5



BARREL SUPPORT
0500/4



HELLFURY CANNON BARREL
0500/6



HELLFURY CANNON END
0500/7



RAM
0500/10



MELTA CANNON
0500/8



DOOMSTORM MISSILES
0500/11



BATTLE CANNON TURRET
0500/9

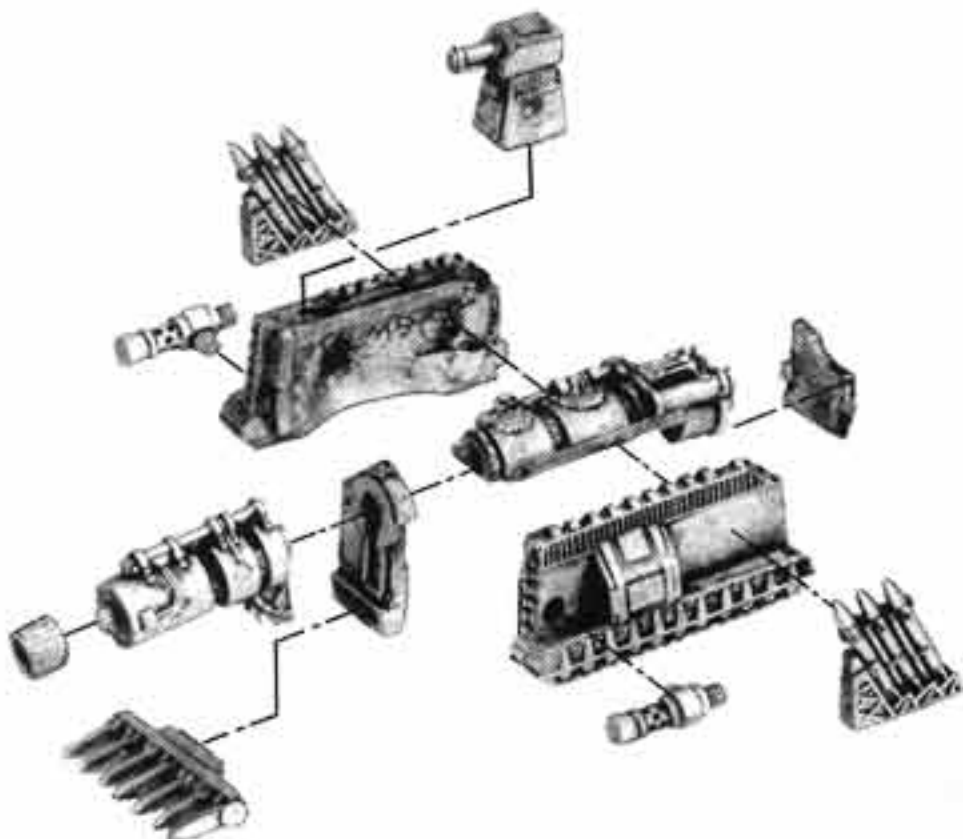

EPIC IMPERIAL

WHIRLWIND

A COMPLETED WHIRLWIND CONSISTS OF:
1 x RHINO CHASSIS
1 x MULTI - LAUNCHER

WHIRLWIND
MULTI - LAUNCHER
76049/16

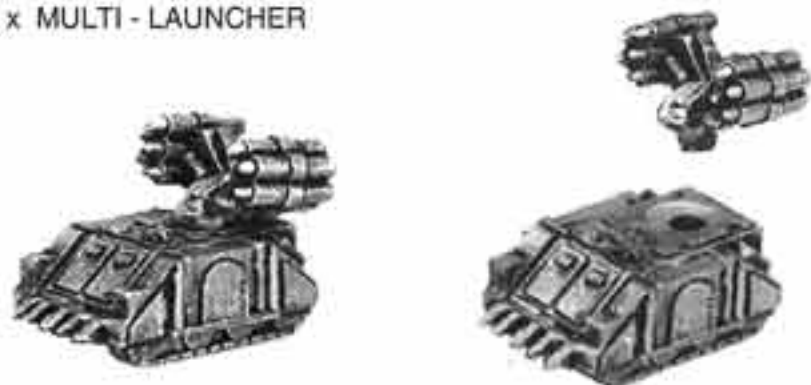

EXAMPLE OF A COMPLETED WHIRLWIND

RHINO CHASSIS
76007/1

HELLHOUND

A COMPLETED HELLHOUND CONSISTS OF:
1 x HELLHOUND CHASSIS
1 x DRAGON FIRE THROWER

DRAGON FIRE
THROWER
76048/23



EXAMPLE OF A COMPLETED HELLHOUND

HELLHOUND CHASSIS
76048/22

HYDRA

A COMPLETED HYDRA CONSISTS OF:
1 x ARTILLERY CHASSIS
1 x HYDRA CANNON RIGHT
1 x HYDRA CANNON LEFT

HYDRA RIGHT
CANNON
76005/1

HYDRA LEFT
CANNON
76005/2

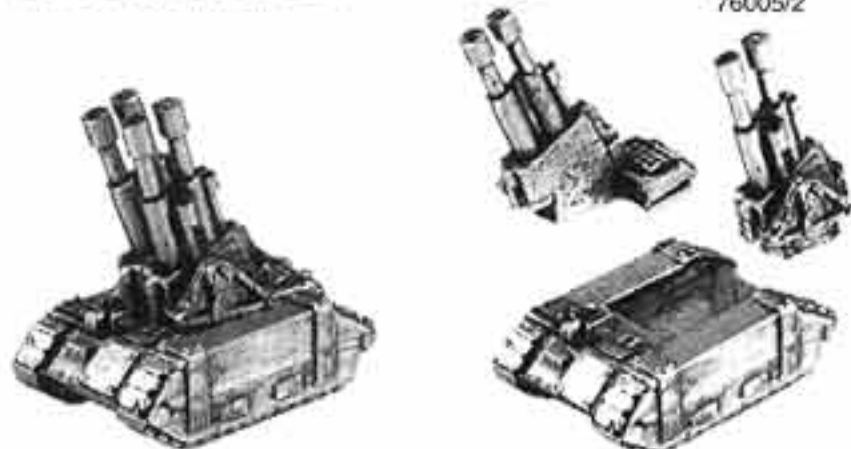

EXAMPLE OF A COMPLETED HYDRA

ARTILLERY CHASSIS
76091/15

MANTICORE

A COMPLETED MANTICORE CONSISTS OF:
1 x ARTILLERY CHASSIS
1 x STORM EAGLE ROCKETS

STORM EAGLE ROCKETS
76092/7

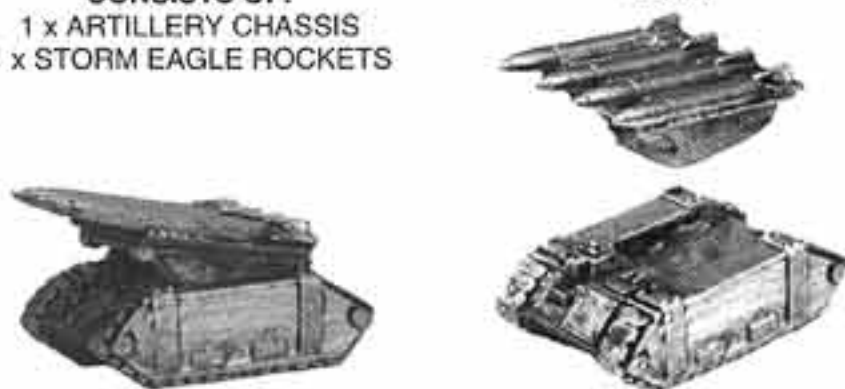

EXAMPLE OF A COMPLETED MANTICORE

ARTILLERY CHASSIS
76091/15

GORGON

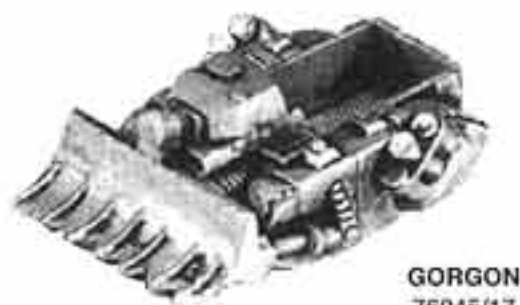

GORGON
76045/17

DEATHSTRIKE MISSILE LAUNCHER

A COMPLETED DEATHSTRIKE MISSILE LAUNCHER CONSISTS OF:
1 x MISSILE CARRIER
1 x DEATHSTRIKE MISSILE

DEATHSTRIKE MISSILE
76095/13

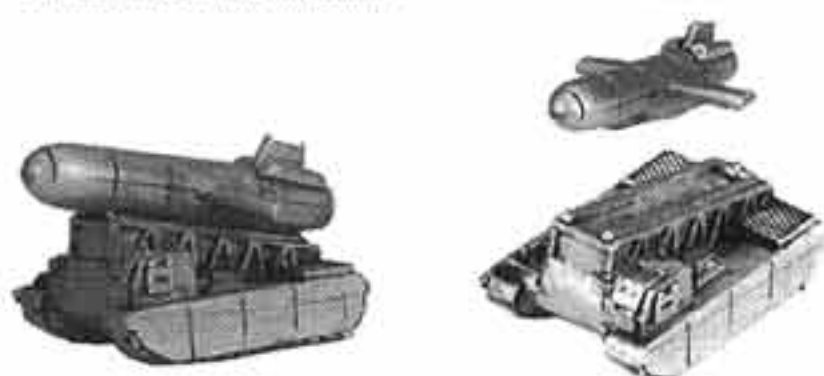

EXAMPLE OF A COMPLETED DEATHSTRIKE MISSILE LAUNCHER

DEATHSTRIKE MISSILE CARRIER
76095/12

BOMBARD

A COMPLETED BOMBARD CONSISTS OF:
1 x BOMBARD CHASSIS
1 x BOMBARD SIEGE MORTAR

BOMBARD SIEGE MORTAR
76094/2



EXAMPLE OF A COMPLETED BOMBARD

BOMBARD CHASSIS
76094/1

BASILISK

A COMPLETED BASILISK CONSISTS OF:
1 x ARTILLERY CHASSIS
1 x EARTHSHAKER CANNON

EARTHSHAKER
CANNON
76091/5



EXAMPLE OF A COMPLETED BASILISK

ARTILLERY CHASSIS
76091/15

IMPERIAL TANKS

LEMAN RUSS BATTLE TANK

A COMPLETE LEMAN RUSS
BATTLE TANK CONSISTS OF:
1 x TURRET
1 x CHASSIS



EXAMPLE OF A COMPLETED
LEMAN RUSS

COMMAND TURRET
0496/3



LEMAN RUSS CHASSIS
0496/1

RECOVERY TURRET
0496/5



LEMAN RUSS RECOVERY CHASSIS
0496/2

STANDARD TURRET
0496/4



LEMAN RUSS CHASSIS
0496/1

Designed by Norman Swales

EPIC® SQUATS

LEVIATHAN

THE COMPLETE LEVIATHAN CONSISTS OF:
1 x CHASSIS RIGHT
1 x CHASSIS LEFT
1 x BATTLE TOWER
1 x BATTLECANNON
1 x DOOMSDAY CANNON

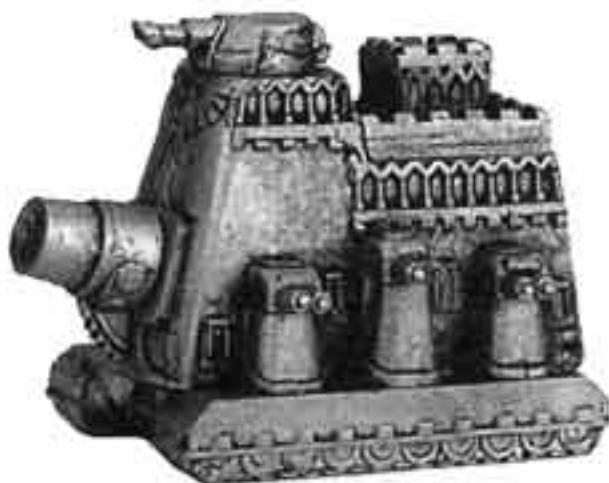

EXAMPLE OF A COMPLETED LEVIATHAN

BATTLECANNON
76113/4



CHASSIS
RIGHT
76113/2



DOOMSDAY
CANNON
76113/3

BATTLE
TOWER
76113/5



CHASSIS
LEFT
76113/1

THUNDERFIRE CANNON



EXAMPLE OF A COMPLETED THUNDERFIRE CANNON

THE COMPLETE SQUAT THUNDERFIRE
CANNON CONSISTS OF
1 x CANNON BASE
1 x UPPER CANNON
1 x LOWER CANNON

UPPER
CANNON
76747/3



LOWER
CANNON
76747/2



CANNON
BASE
76747/1

Designed by Norman Swales

IMPERIAL TITANS

REAYER TITANS

A COMPLETE REAYER TITAN

CONSISTS OF:

- 1 x HEAD
- 2 x SHOULDER GUARD
- 1 x CARAPACE
- 2 x FEET
- 1 x LEGS
- 3 x WEAPONS



EXAMPLES OF COMPLETED REAYER TITANS

SHOULDER
GUARD 1
0499/12



BANNER POLE
76002/19



MULTIPLE
ROCKET LAUNCHER
0499/14



REAYER
CARAPACE
0499/8



SHOULDER
GUARD 2
0499/12



VULCAN
MEGA-BOLTER
00493/7

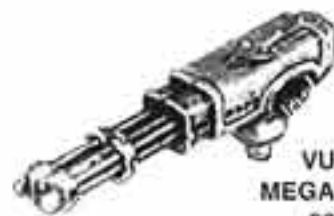

REAYER
HEAD
0499/17



REAYER
LEGS
0499/9



PLASMA BLAST GUN
00493/6

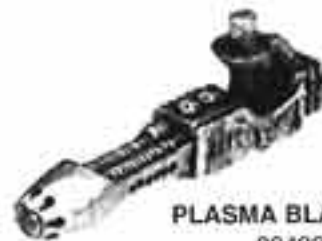

REAYER POWERFIST
00499/18



REAYER FOOT
0499/10



REAYER FOOT
0499/10



INFERNO GUN
00493/5



REAYER CHAINFIST
76002/16



TURBO-LASER
DESTRUCTOR
00493/4



© Copyright Games Workshop Ltd 1994. All rights reserved.



EPIC® IMPERIAL

WARHOUND TITANS

A COMPLETE WARHOUND TITAN CONSISTS OF:
 1 x HEAD AND TORSO
 2 x WEAPONS
 1 x LEGS
 1 x CONNECTING RING



EXAMPLES OF COMPLETED WARHOUND TITANS

VULCAN MEGA-BOLTER
 00493/7



TORSO AND HEAD
 076015/2



PLASMA BLASTGUN
 00493/6



INFERNO GUN
 00493/5



CONNECTING RING
 076015/3



TURBO-LASER DESTROYER
 00493/4



LEGS 1
 076015/1



LEGS 2
 00493/8



Designed by Jes Goodwin

KNIGHT ERRANT

A COMPLETE KNIGHT ERRANT CONSISTS OF:
 1 x ERRANT BODY
 1 x THERMAL CANNON
 1 x POWER FIST



EXAMPLE OF A COMPLETED KNIGHT ERRANT

THERMAL CANNON
 76008/2



POWER FIST
 76008/3



ERRANT BODY
 76008/1



KNIGHT CRUSADER

A COMPLETE KNIGHT CRUSADER CONSISTS OF:
 1 x CRUSADER BODY
 1 x LASCANNON
 1 x QUAKE CANNON



EXAMPLE OF A COMPLETED KNIGHT CRUSADER

LASCANNON
 76008/2



QUAKE CANNON
 76008/3



CRUSADER BODY
 76008/1



Designed by Dave Andrews

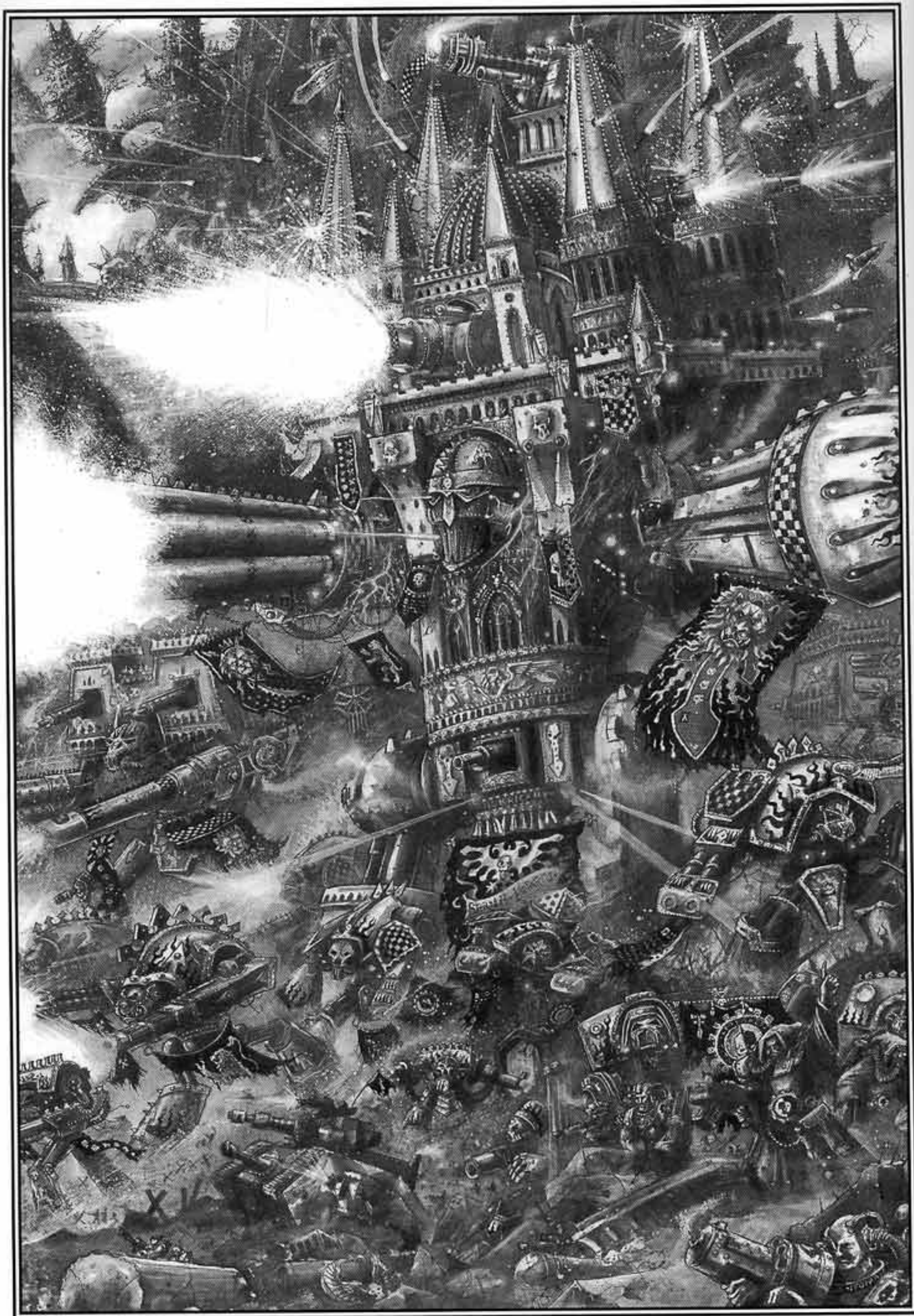

EPIC ORKS

BOWEL BURNA

A COMPLETE BOWEL BURNA
CONSISTS OF:
1 x BOWEL BURNA CHASSIS
1 x BOWEL BURNA TURRET



EXAMPLE OF A COMPLETED
BOWEL BURNA

BOWEL BURNA
TURRET
76256/10



BOWEL BURNA CHASSIS
76256/9

SQUIG CATAPULT

A COMPLETE SQUIG CATAPULT
CONSISTS OF:
1 x SQUIG CATAPULT TOWER
1 x SQUIG CATAPULT BASE



EXAMPLE OF A COMPLETED
SQUIG CATAPULT

SQUIG
CATAPULT
TOWER
76267/6



SQUIG
CATAPULT
BASE
76267/5

SQUIGGOTHS



SQUIGGOTH 1
76266/4



SQUIGGOTH 2
76266/7

GOBSMASHA



GOBSMASHA
76257/11

SPLEENRIPPA

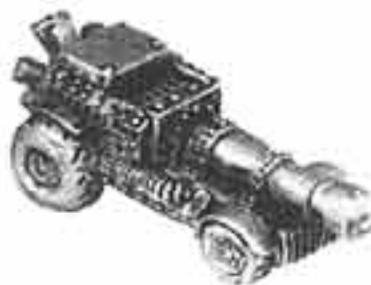

SPLEENRIPPA
76258/12

PULSA ROKKIT



PULSA ROKKIT
76274/1

WIERDBOY BATTLE TOWER

A COMPLETE WIERDBOY BATTLE TOWER
CONSISTS OF:
1 x WIERDBOY TOWER
1 x BATTLEWAGON



EXAMPLE OF A COMPLETED
WIERDBOY BATTLE TOWER

WIERDBOY
TOWER
76291/14

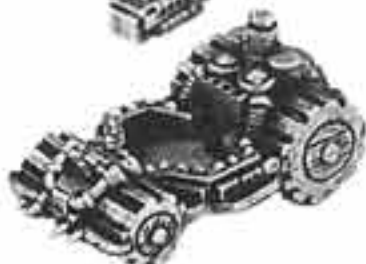

BATTLEWAGON
76291/13

DOOMDIVER MAGNA CANNON

A COMPLETE DOOMDIVER MAGNA CANNON
CONSISTS OF:
1 x MAGNA CANNON
1 x DOOMDIVER CHASSIS



EXAMPLE OF A COMPLETED
DOOMDIVER MAGNA CANNON

MAGNA CANNON
76200/1



DOOMDIVER CHASSIS
76200/1

MEKBOY SPEEDSTAS



SPEEDSTA VARIANT 1
76234/7



SPEEDSTA VARIANT 2
76233/5



SPEEDSTA VARIANT 3
76233/5

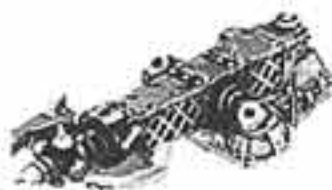

LIFTA DROPPA
TURRET
76234/3



DESTRUKTA ROKKITS
TURRET
76233/6



BUBBLE CHUKKA
TURRET
76233/8



MEKBOY DRAGSTER
76234/1



A COMPLETE
MEKBOY SPEEDSTA
CONSISTS OF:
1 x SPEEDSTA VARIANT
1 x SPEEDSTA TURRET

EXAMPLES OF COMPLETED ORK SPEEDSTAS

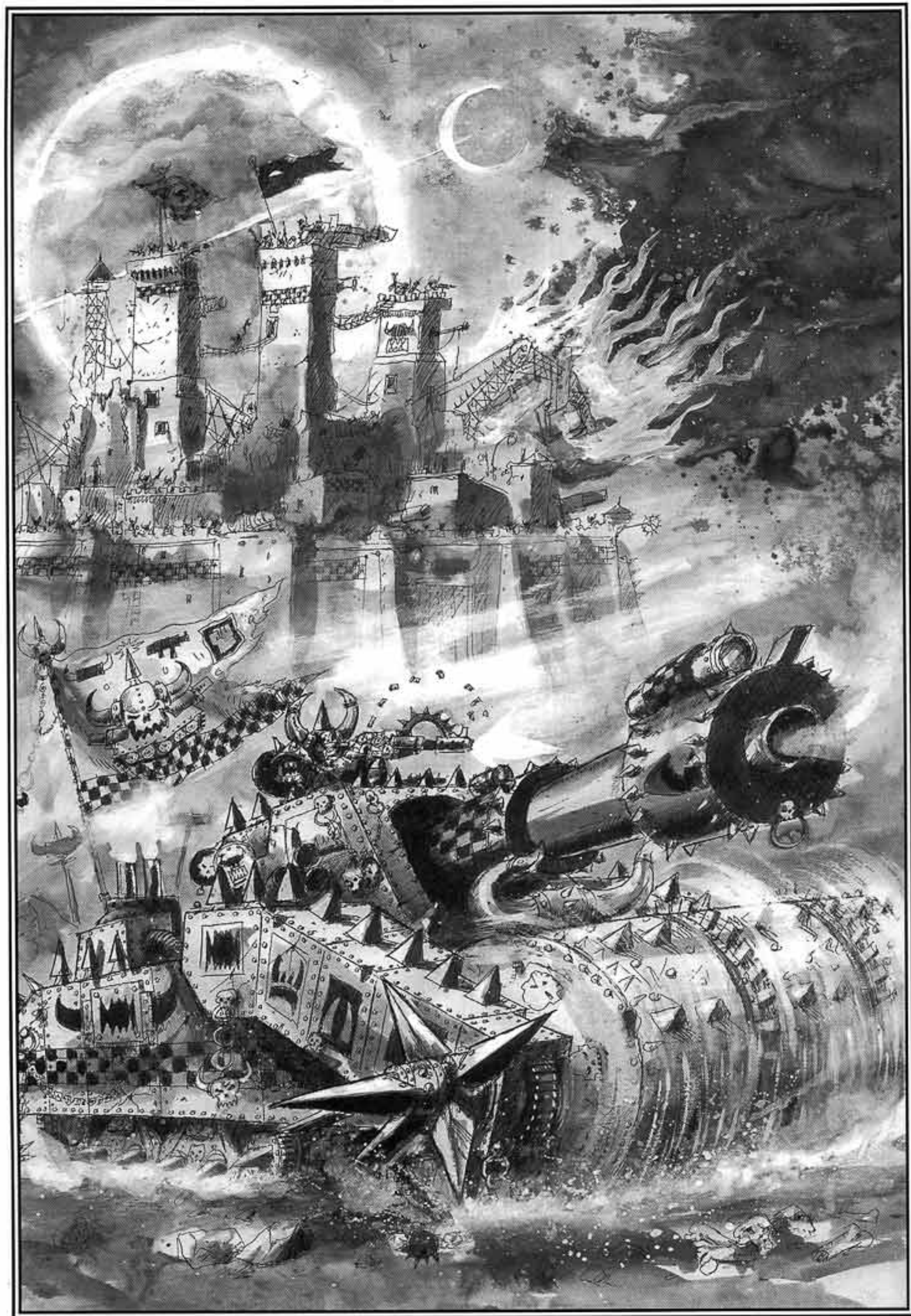

ORK GARGANTS

MEKBOY GARGANT

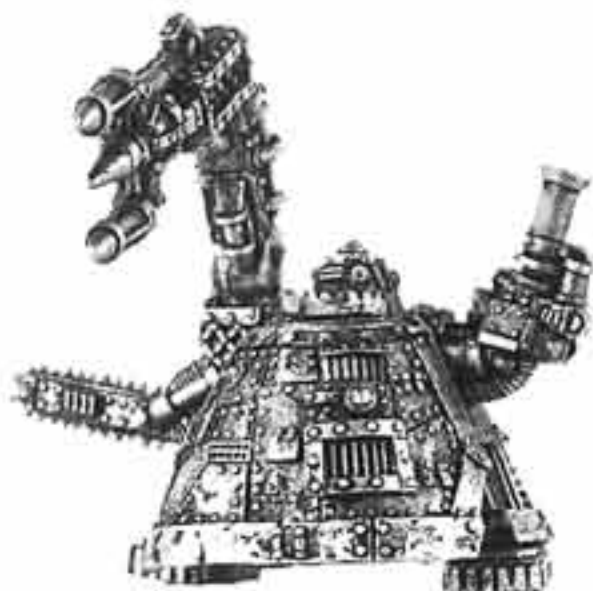

EXAMPLE OF A COMPLETED MEKBOY GARGANT

A COMPLETE MEKBOY GARGANT
CONSISTS OF:
1 x MEKBOY GARGANT BODY
1 x MEKBOY GARGANT BELLY
1 x MEKBOY GARGANT ARM VARIANT



SUPER LIFTA
DROPPA ARM
0495/4



BUZZ SAW ARM
0495/3



KRUSHER ARM
0495/5

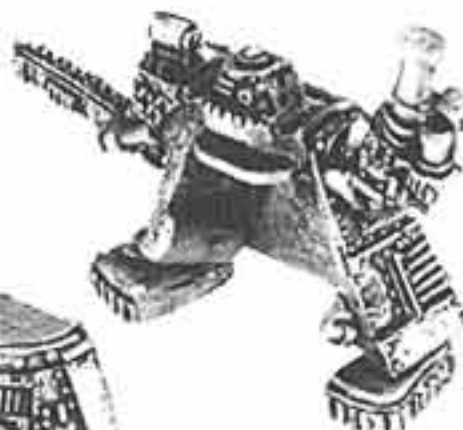

MEKBOY
GARGANT
BODY
0495/1

MEKBOY
GARGANT
BELLY
0495/2



SLASHER GARGANT



EXAMPLE OF A COMPLETED SLASHER GARGANT



CLUSTER BUSTER
0497/11



SLASHER MORK
HEAD 2
76211/9



RIPPER FIST
0497/6



SLASHA ATTACK GUN
0497/7



SLASHER GORK
HEAD 1
0497/5

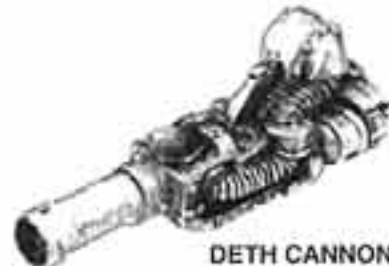

DETH CANNON
0497/10



SLASHER
RIGHT SIDE
0497/2

SLASHER
FRONT
0497/4



SLASHER
BACK
0497/3

A COMPLETE SLASHER GARGANT
CONSISTS OF:
1 x SLASHER FRONT
1 x SLASHER BACK
1 x SLASHER RIGHT SIDE
1 x SLASHER LEFT SIDE
1 x SLASHER BELLY GUN
1 x SLASHER HEAD
2 x SLASHER WEAPONS



SLASHER BELLY GUN
0497/8



SLASHER
LEFT SIDE
0497/1

ELDAR TITANS

PHANTOM TITAN

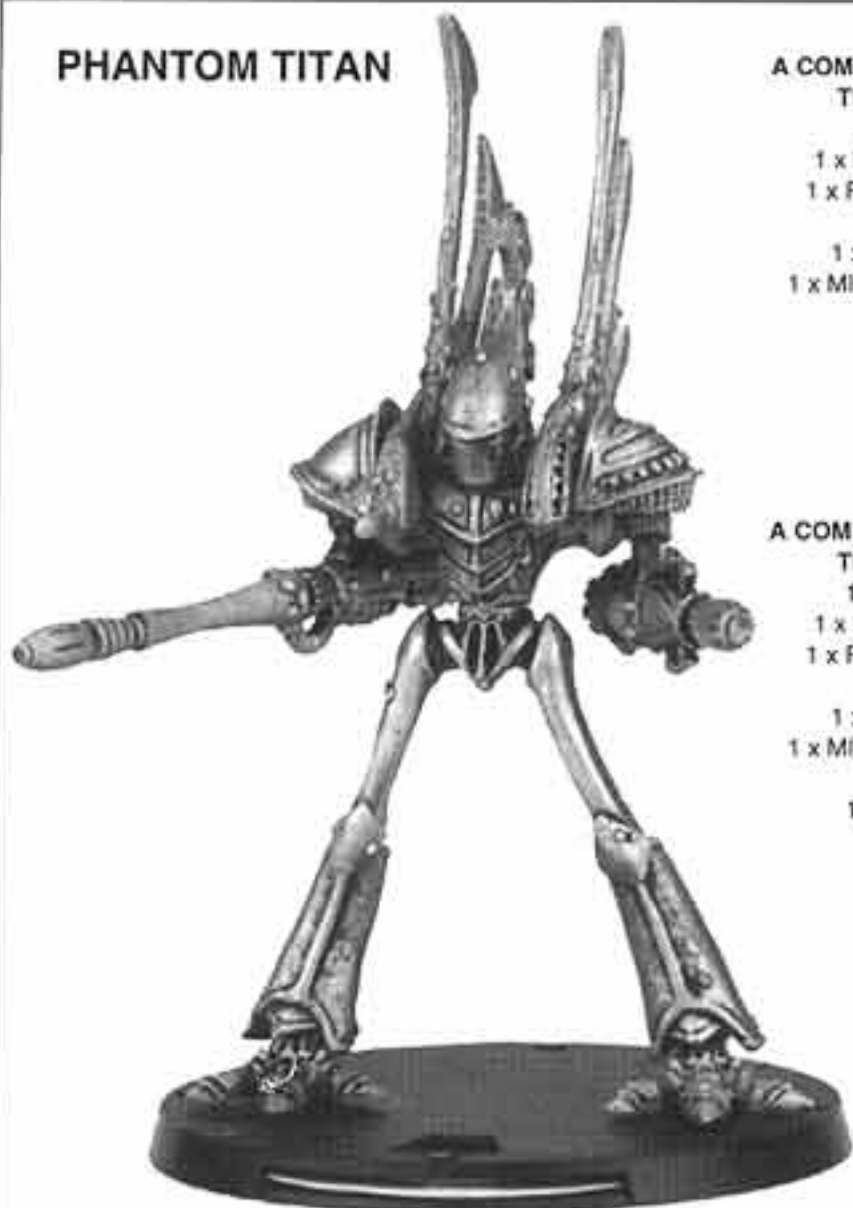

EXAMPLE OF COMPLETE ELDAR PHANTOM TITAN

A COMPLETE ELDAR PHANTOM TITAN CONSISTS OF:

- 1 x HEAD
- 1 x LEFT SHOULDER PAD
- 1 x RIGHT SHOULDER PAD
- 1 x TORSO
- 1 x LASCANNON WING
- 1 x MISSILE LAUNCHER WING
- 2 x WEAPONS
- 1 x LEGS
- 2 x FEET

WARLOCK TITAN

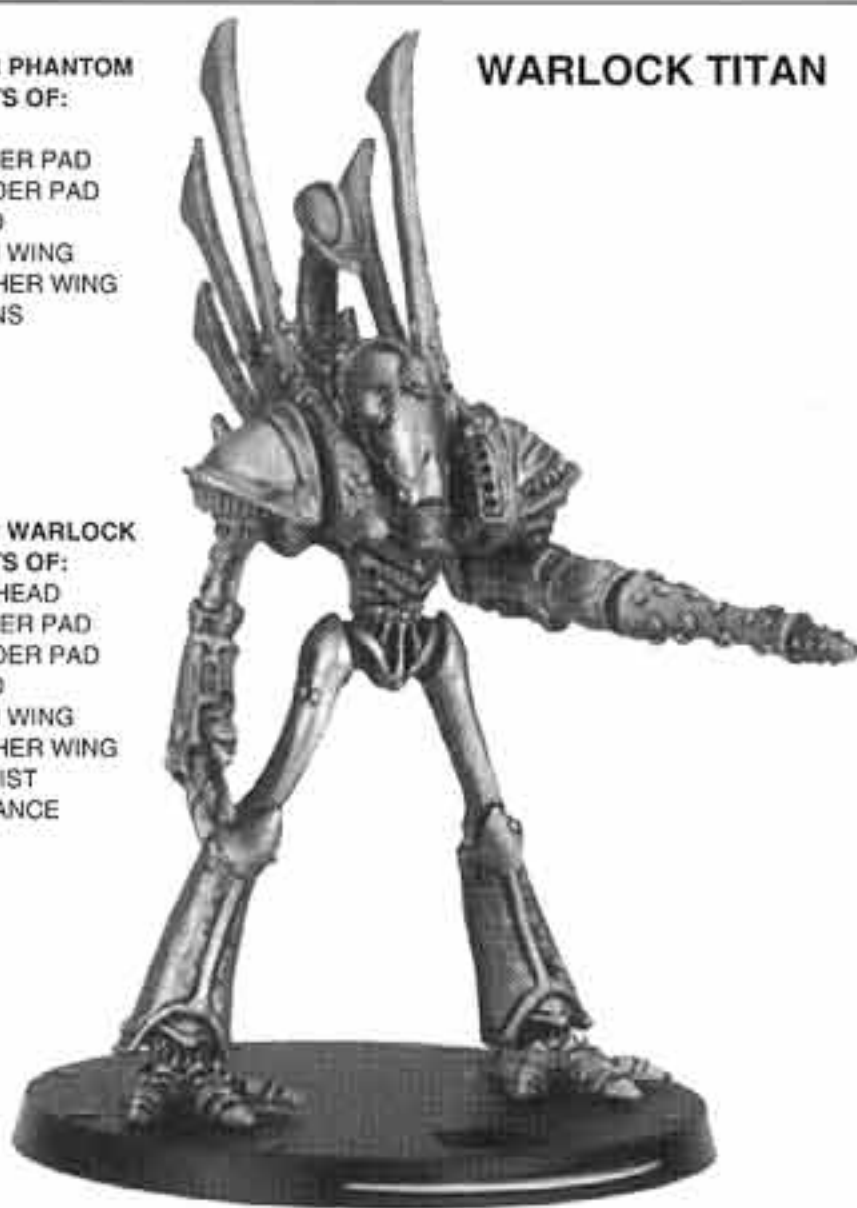

EXAMPLE OF COMPLETE ELDAR WARLOCK TITAN

A COMPLETE ELDAR WARLOCK TITAN CONSISTS OF:

- 1 x WARLOCK HEAD
- 1 x LEFT SHOULDER PAD
- 1 x RIGHT SHOULDER PAD
- 1 x TORSO
- 1 x LASCANNON WING
- 1 x MISSILE LAUNCHER WING
- 1 x POWER FIST
- 1 x PSYCHIC LANCE
- 1 x LEGS
- 2 x FEET

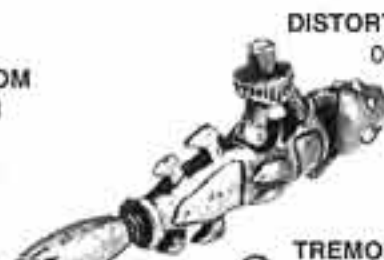
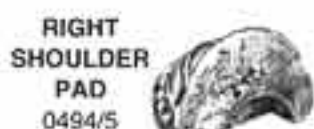
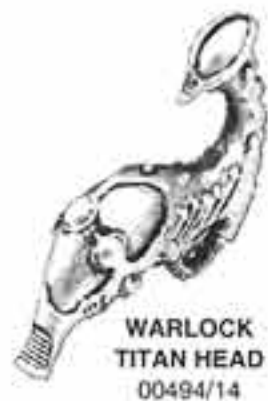

EPIC ELДАР

ELДАР NIGHTWING

A COMPLETE ELДАР NIGHTWING CONSISTS OF:
 1 x NIGHTWING HULL
 1 x NIGHTWING TAIL
 1 x NIGHTWING GUN



EXAMPLE OF COMPLETE NIGHTWING

NIGHTWING GUN
 76435/3



NIGHTWING HULL
 76435/1



NIGHTWING TAIL
 76435/2

TEMPEST GRAV TANK

A COMPLETE TEMPEST GRAV TANK CONSISTS OF:
 1 x TEMPEST GRAV CHASSIS
 1 x LASER AND SHURIKEN TURRETS



EXAMPLE OF COMPLETE TEMPEST GRAV TANK

TEMPEST LASER AND SHURIKEN CANNON TURRETS
 76420/2



TEMPEST GRAV CHASSIS
 76420/1



ELДАР WAVE SERPENT

A COMPLETE ELДАР WAVE SERPENT CONSISTS OF:
 1 x WARP ENERGY GENERATOR
 1 x WAVE SERPENT HULL



EXAMPLE OF COMPLETE WAVE SERPENT

WARP ENERGY GENERATOR
 76421/7



WAVE SERPENT HULL
 76421/6

ELДАР WARP HUNTER



WARP HUNTER
 76422/3

ELДАР FIRESTORM

A COMPLETE ELДАР FIRESTORM CONSISTS OF:
 1 x FIRESTORM LASER BATTERY
 1 x ELДАР GRAV HULL



EXAMPLE OF COMPLETE FIRESTORM

FIRESTORM LASER BATTERY
 76436/1



ELДАР GRAV HULL
 76423/4



ELДАР DEATHSTALKER

A COMPLETE ELДАР DEATHSTALKER CONSISTS OF:
 1 x PRISM CANNON
 1 x ELДАР GRAV HULL



EXAMPLE OF COMPLETE DEATHSTALKER

PRISM CANNON
 76423/5



ELДАР GRAV HULL
 76423/4



ELДАР DOOMWEAVER

A COMPLETE ELДАР DOOMWEAVER CONSISTS OF:
 1 x DOOMWEAVER WEB SPINNER
 1 x ELДАР GRAV HULL



EXAMPLE OF COMPLETE DOOMWEAVER

DOOMWEAVER WEB SPINNER
 76424/8



ELДАР GRAV HULL
 76423/4



© Copyright Games Workshop Ltd 1994. All rights reserved.



EPIC CHAOS

DEATHDEALER



EXAMPLE OF COMPLETE DEATHDEALER

THE COMPLETE DEATHDEALER CONSISTS OF:
 1 x DEATHDEALER GUN TOWER
 1 x DEATHDEALER BASE
 1 x DEATHDEALER MACHINE WARRIOR



DEATHDEALER GUN TOWER
76543/2

DEATHDEALER MACHINE WARRIOR
76543/3



DEATHDEALER BASE
76543/1



DOOM BLASTER



EXAMPLE OF COMPLETE DOOM BLASTER

THE COMPLETE DOOM BLASTER CONSISTS OF:
 1 x DOOM BLASTER LEFT MORTAR
 1 x DOOM BLASTER RIGHT MORTAR
 1 x BATTLE SCYTHE
 1 x DOOM BLASTER BASE



DOOM BLASTER RIGHT MORTAR
76545/15



DOOM BLASTER LEFT MORTAR
76545/14



BATTLE SCYTHE 3
76545/16

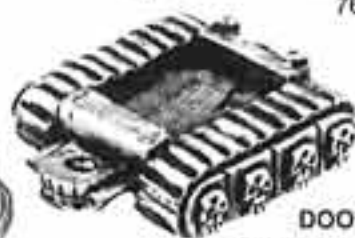

DOOM BLASTER BASE
76545/13

TOWER OF SKULLS

THE COMPLETE TOWER OF SKULLS CONSISTS OF:
 1 x SKULL TOWER
 1 x BATTLE SCYTHE
 1 x TOWER OF SKULLS BASE



EXAMPLE OF COMPLETE TOWER OF SKULLS



SKULL TOWER
76541/8



TOWER OF SKULLS BASE
76541/7



BATTLE SCYTHE 2
76541/9

ANGRON



DAEMON PRIMARCH OF KHORNE
76550/21

BLOODTHIRSTER



GREATER DAEMON OF KHORNE
76551/17

BLOOD REAPER



EXAMPLE OF COMPLETE BLOOD REAPER

THE COMPLETE BLOOD REAPER CONSISTS OF:
 1 x SKULL CANNON
 1 x BATTLE SCYTHE
 1 x BLOOD REAPER RIGHT TOWER
 1 x BLOOD REAPER LEFT TOWER

EXAMPLE OF COMPLETE BLOOD REAPER

SKULL CANNON
76546/19



BLOOD REAPER RIGHT TOWER
76546/17



BATTLE SCYTHE 4
76546/20



BLOOD REAPER LEFT TOWER
76546/18



CAULDRON OF BLOOD

THE COMPLETE CAULDRON OF BLOOD CONSISTS OF:
 1 x CAULDRON OF BLOOD TOWER
 1 x BATTLE SCYTHE
 1 x CAULDRON OF BLOOD BASE



EXAMPLE OF COMPLETE CAULDRON OF BLOOD

CAULDRON OF BLOOD TOWER
76542/5



CAULDRON OF BLOOD BASE
76542/4



BATTLE SCYTHE 1
76542/6



EPIC® ORKS

LUNGBURSTA



LUNGBURSTA
76251

GIBLET GRINDA

THE COMPLETE GIBLET GRINDA CONSISTS OF

- 1 x GIBLET GRINDA CHASSIS
- 1 x GIBLET GRINDA TOWER
- 2 x GIBLET GRINDA TURRET



EXAMPLE OF A COMPLETED GIBLET GRINDA

GIBLET GRINDA
TOWER
76230/5



GIBLET GRINDA
TURRET
76230/6



GIBLET GRINDA
CHASSIS
76230/4

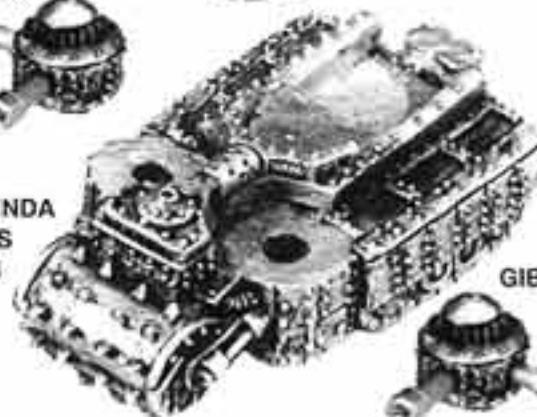

GIBLET GRINDA
TURRET
76230/6



SKULLHAMMA

THE COMPLETE SKULLHAMMA CONSISTS OF

- 1 x SKULLHAMMA CHASSIS
- 1 x SKULLHAMMA BOILER
- 2 x SKULLHAMMA TURRET



EXAMPLE OF A COMPLETED SKULLHAMMA

SKULLHAMMA
TURRET
76230/4



SKULLHAMMA
BOILER
76231/2



SKULLHAMMA
CHASSIS
76231/1



SKULLHAMMA
TURRET
76230/4



EPIC® CHAOS

BRASS SCORPION

THE COMPLETE BRASS SCORPION CONSISTS OF

- 1 x BRASS SCORPION CHASSIS
- 1 x BRASS SCORPION CANNON
- 2 x POWER SAWS



EXAMPLE OF A COMPLETED BRASS SCORPION

BRASS SCORPION
CANNON
76544/11



POWER
SAW
76544/12



BRASS SCORPION
CHASSIS
76544/10



POWER
SAW
76544/12

MORTARION



MORTARION
76506/20

SPACE MARINES

JUMP PACK ASSAULT TROOPS



JUMP PACK TROOPER 1
0426/2



JUMP PACK TROOPER 2
0426/1



JUMP PACK SERGEANT 1
0426/3



JUMP PACK TROOPER 3
70100/2



JUMP PACK TROOPER 4
70100/3



JUMP PACK SERGEANT 2
70100/1

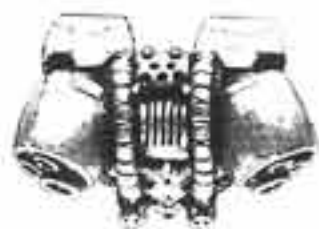

JUMP PACK
0426/4

A COMPLETE JUMP PACK ASSAULT
TROOPER CONSISTS OF:
1 x JUMP PACK MARINE
1 x JUMP PACK
1 x PLASTIC MARINE ARMS SPRUE
1 x MARINE CLOSE COMBAT SPRUE



EXAMPLES OF COMPLETED JUMP PACK ASSAULT TROOPS

SPACE MARINES®



SPACE MARINE
MK2 'CRUSADE' ARMOUR
70106/45



SPACE MARINE
MK3 'IRON' ARMOUR
70106/44



SPACE MARINE
MK4 'MAXIMUS' ARMOUR
70106/47



SPACE MARINE
MK5 'HERESY' ARMOUR
70106/46



SPACE MARINE
MK6 ARMOUR 1
70106/48



SPACE MARINE
MK6 ARMOUR 2
70106/49



SPACE MARINE
MK6 ARMOUR 3
70119/42



SPACE MARINE
MK6 ARMOUR 4
70119/43



SPACE MARINE
MK7 ARMOUR 1
70106/50



SPACE MARINE
MK7 ARMOUR 2
70106/51



SPACE MARINE
MK7 ARMOUR 3
0819/1



SPACE MARINE
MK7 ARMOUR 4
0819/2



SPACE MARINE
MK7 ARMOUR 5
70106/55



SPACE MARINE
MK7 ARMOUR 6
70106/58



SPACE MARINE
MK7 ARMOUR 7
70106/54



SPACE MARINE
MK8 'ERRANT' ARMOUR
70106/57

THESE MINIATURES ARE SUPPLIED WITH A SEPARATE PLASTIC SPACE MARINE ARM SPRUE AND A SPACE MARINE BOLTER AND BACKPACK SPRUE.



EXAMPLES OF COMPLETED MK7, MK6 AND MK3 SPACE MARINES.

SPACE MARINES

SPACE MARINE DEVASTATORS

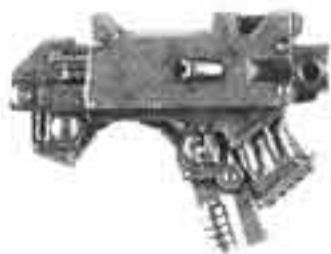

HEAVY BOLTER
0813/6



IMPERIAL LASCANNON
0813/5



MISSILE LAUNCHER
0813/4



MK7 SPACE MARINE
DEVASTATOR 1
0813/2



MK7 SPACE MARINE
DEVASTATOR 2
0813/3

THESE MINIATURES ARE SUPPLIED WITH A SEPARATE PLASTIC SPACE MARINE ARM SPRUE AND A PLASTIC SPACE MARINE BACKPACK SPRUE.



EXAMPLES OF COMPLETED MK7 SPACE MARINE DEVASTATORS

SPACE MARINES WITH SPECIAL WEAPONS



SPACE MARINE
WITH FLAMER
0819/4



SPACE MARINE
WITH MELTA GUN
0808/2



SPACE MARINE
WITH PLASMA GUN
0421/2

THESE MINIATURES ARE SUPPLIED WITH A SEPARATE PLASTIC SPACE MARINE BACKPACK SPRUE.

Miniatures supplied unpainted. WARNING: This product contains lead which may be harmful if chewed or swallowed. Citadel Miniatures are not recommended for children under 14 years of age.
© Copyright Games Workshop Ltd 1993. All rights reserved.





SPACE MARINE RAZORBACK™

RAZORBACK



EXAMPLE OF AN ASSEMBLED SPACE MARINE RAZORBACK PAINTED IN THE COLOURS OF THE ULTRAMARINES



GUNNER
0433/1



LEFT HATCH
0433/7



MIDDLE HATCH
0433/6



RIGHT HATCH
0433/8

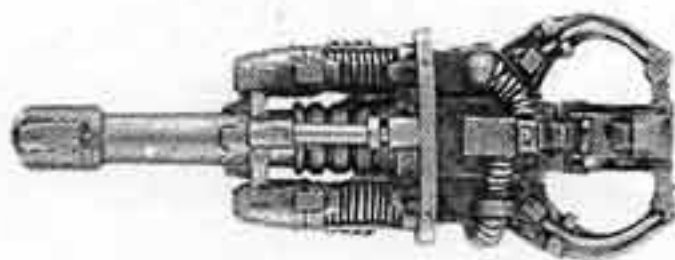

RAZORBACK GUN
0433/5



GUN SHIELD
0433/4

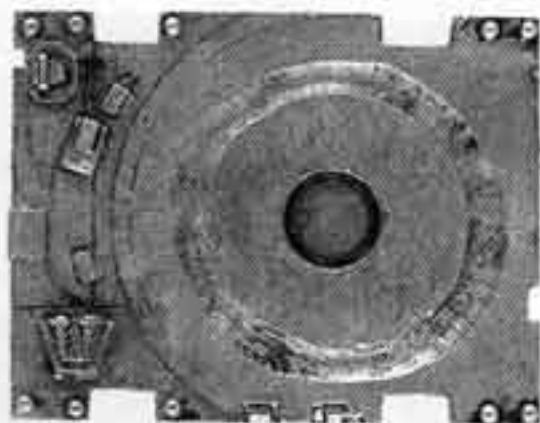

TOP PLATE
0433/2

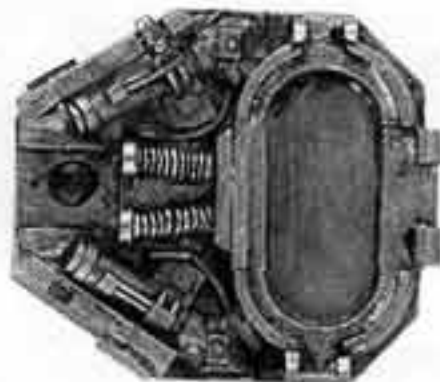

TURRET
0433/3

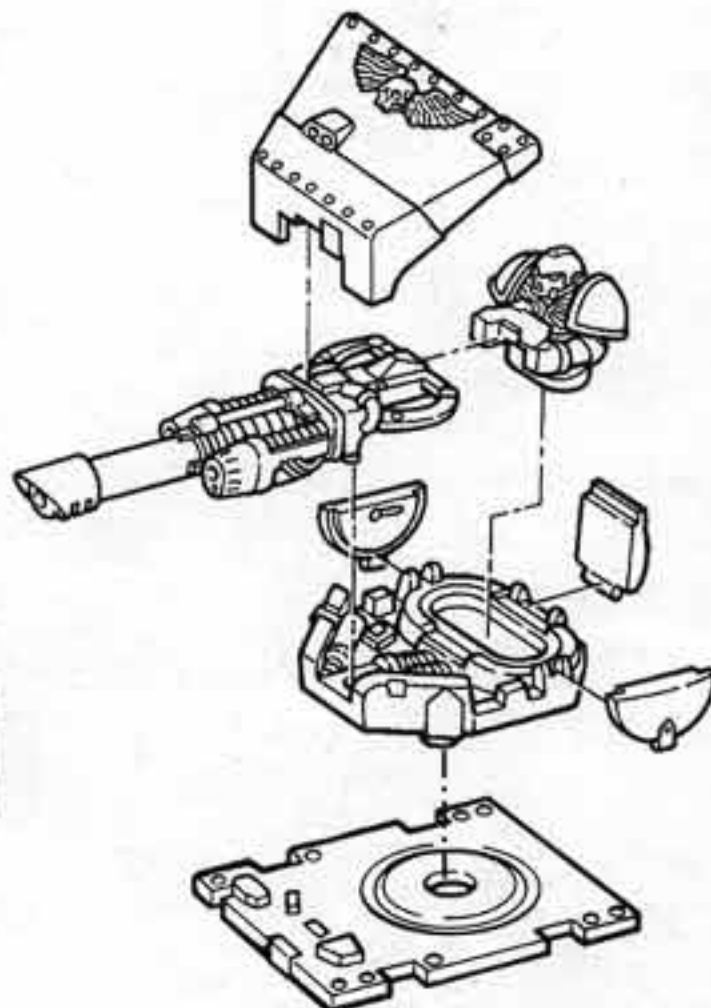

THE COMPLETE SPACE MARINE RAZORBACK CONSISTS OF:
 2 x RHINO CHASSIS SPRUE
 2 x RHINO TRACK SPRUE
 1 x GUNNER
 1 x LEFT HATCH
 1 x MIDDLE HATCH
 1 x RIGHT HATCH
 1 x RAZORBACK GUN
 1 x GUN SHIELD
 1 x TURRET
 1 x TOP PLATE

THIS MODEL INCLUDES A DETAILED CONSTRUCTION SHEET AND FIVE CITADEL TRANSFER SHEETS WHICH INCLUDE ALL THE MARKINGS NEEDED FOR THE DARK ANGELS, ULTRAMARINES, SPACE WOLVES AND BLOOD ANGELS CHAPTERS.

Designed by Norman Swales and Jes Goodwin

SPACE MARINES

BLOOD ANGEL DEATH COMPANY



BLOOD ANGEL DEATH
COMPANY TROOPER 1
0424/3



BLOOD ANGEL DEATH
COMPANY TROOPER 2
0424/4



BLOOD ANGEL DEATH
COMPANY TROOPER 3
0424/2



BLOOD ANGEL
CHAPLAIN
0424/1

THESE MINIATURES ARE SUPPLIED WITH PLASTIC SPACE MARINE ARMS, CLOSE COMBAT AND BACKPACK SPRUES



EXAMPLES OF COMPLETED DEATH COMPANY

Designed by Jes Goodwin

HOBGOBLINS

HOBGOBLIN HERO ON WOLF

THIS MODEL IS SUPPLIED WITH A PLASTIC WOLF SPRUE AS STANDARD

THE COMPLETED HOBGOBLIN HERO ON WOLF CONSISTS OF:
1 x HOBGOBLIN HERO BODY
1 x CLOAK
1 x QUIVER
1 x WOLF HEAD
1 x PLASTIC WOLF SPRUE



EXAMPLE OF COMPLETED
HOBGOBLIN HERO ON WOLF



HOBGOBLIN HERO BODY
75863/1



CLOAK
75863/2



QUIVER
75863/3



WOLF HEAD
75863/4

Designed by Alan Perry

SPACE MARINES®

SPACE MARINE CHAPLAINS



CHAPLAIN 1
70701/3



CHAPLAIN 2
70101/2



CHAPLAIN 3
70101/1



CHAPLAIN 4
70101/4



CHARACTER EQUIPMENT SPRUE
102533

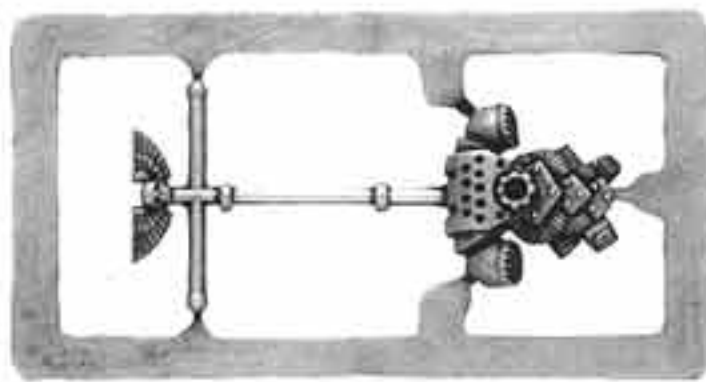

CHARACTER BACKPACK SPRUE
102532

EACH OF THESE MINIATURES IS SUPPLIED WITH A PLASTIC CHARACTER EQUIPMENT SPRUE AND A PLASTIC CHARACTER BACKPACK SPRUE ALLOWING A VARIETY OF POSES



EXAMPLES OF COMPLETED SPACE MARINE CHAPLAINS

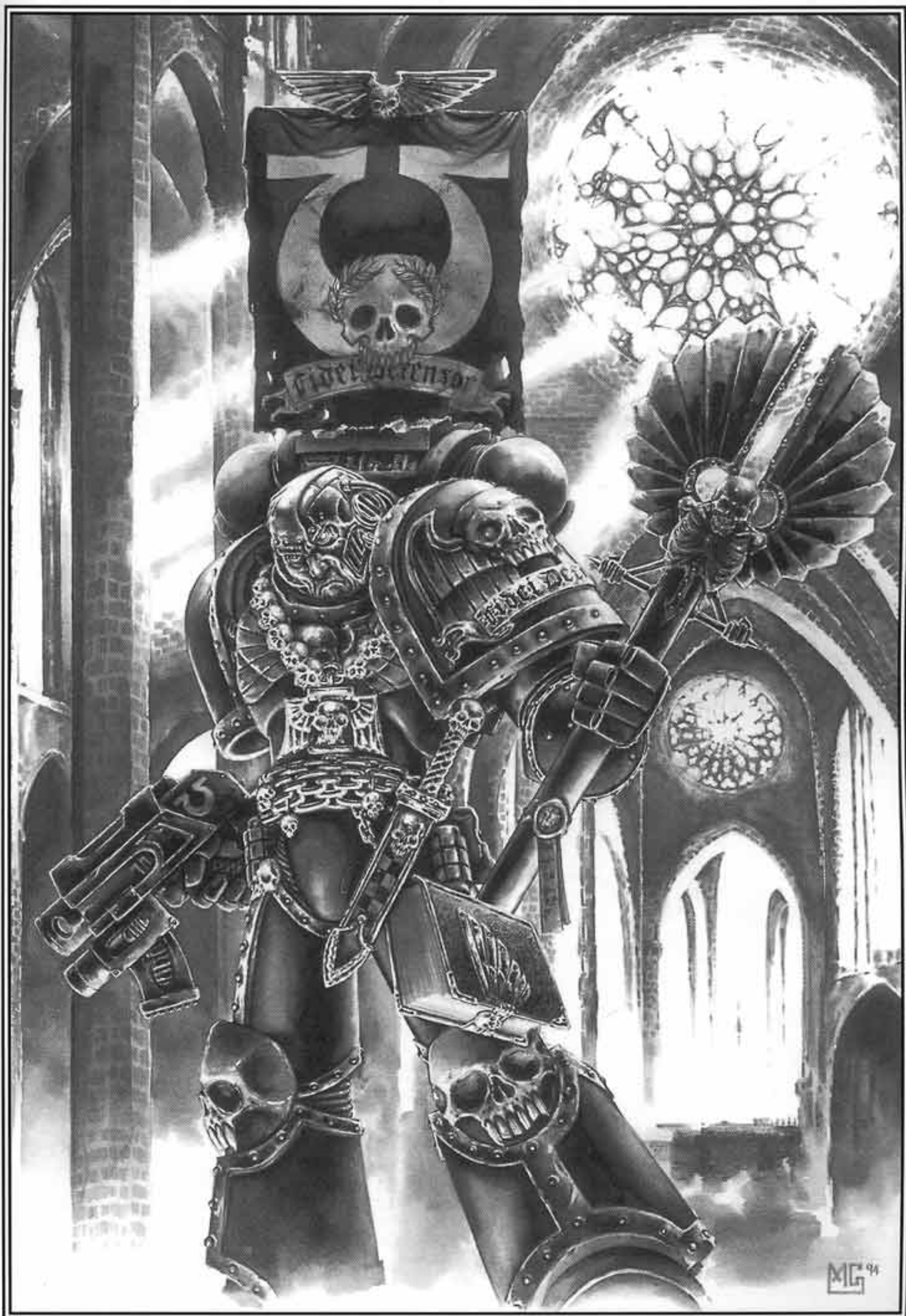

SPACE MARINES®

SPACE MARINE LAND SPEEDER

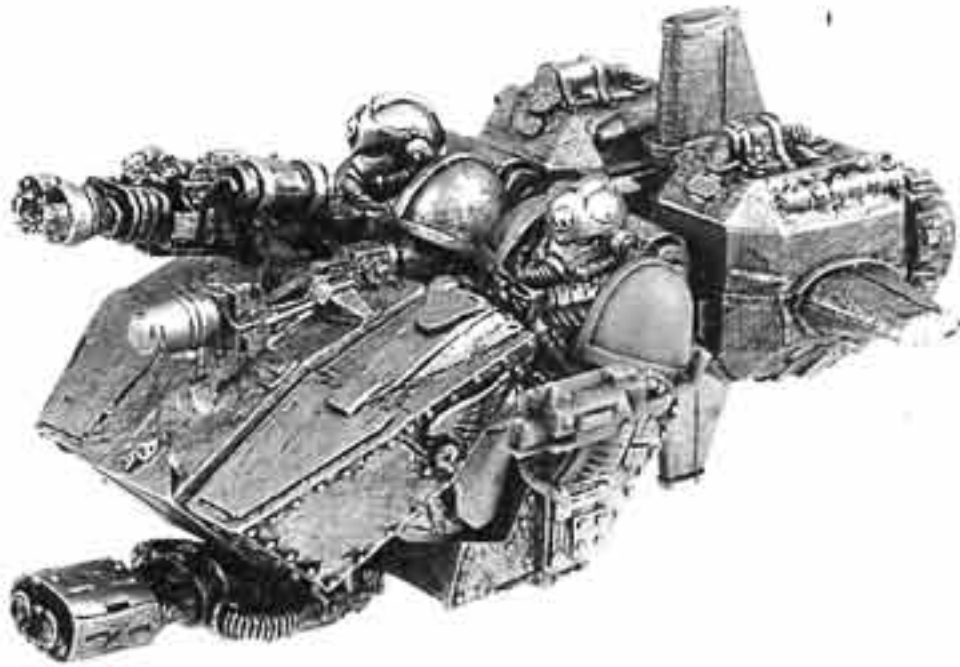

EXAMPLE OF A COMPLETED SPACE MARINE LAND SPEEDER

- THE COMPLETED SPACE MARINE LAND SPEEDER CONSISTS OF**
- 1 x SPACE MARINE PILOT
 - 1 x SPACE MARINE GUNNER
 - 1 x HEAVY FLAMER
 - 1 x MULTIMELTA
 - 1 x LAND SPEEDER CHASSIS
 - 1 x LAND SPEEDER FOOT REST
 - 1 x STABILISER FIN
 - 1 x LEFT FAIRING
 - 1 x RIGHT FAIRING
 - 2 x ENGINE NOZZLES
 - 2 x LAND SPEEDER SEATS
 - 2 x LAND SPEEDER BACK RESTS
 - 1 x PLASTIC CHARACTER EQUIPMENT SPRUE
 - 1 x ENGINE POD TOP
 - 1 x ENGINE POD BOTTOM
 - 1 x PLASTIC FLYING BASE



MULTIMELTA
00439/13

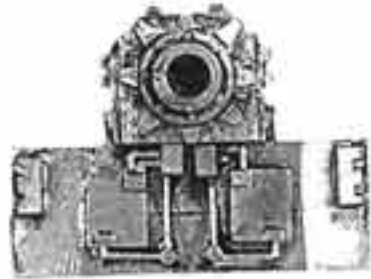

LAND SPEEDER FOOT REST
00439/8



RIGHT FAIRING
00439/7



LEFT FAIRING
00439/6



HEAVY FLAMER
00439/14



ENGINE POD BOTTOM
00439/4



SPACE MARINE PILOT
00439/2



SPACE MARINE GUNNER
00439/1

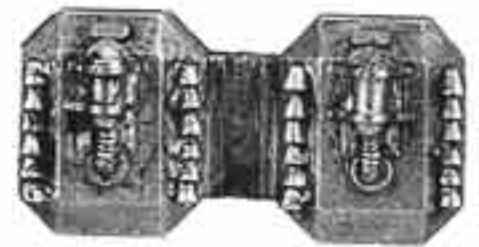

ENGINE POD TOP
00439/5



BACK REST
00439/11



STABILISER FIN
00439/9



SEAT
00439/10



CHASSIS
00439/3



ENGINE NOZZLE
00439/12

SPACE MARINES®

ASSEMBLY STAGE 1

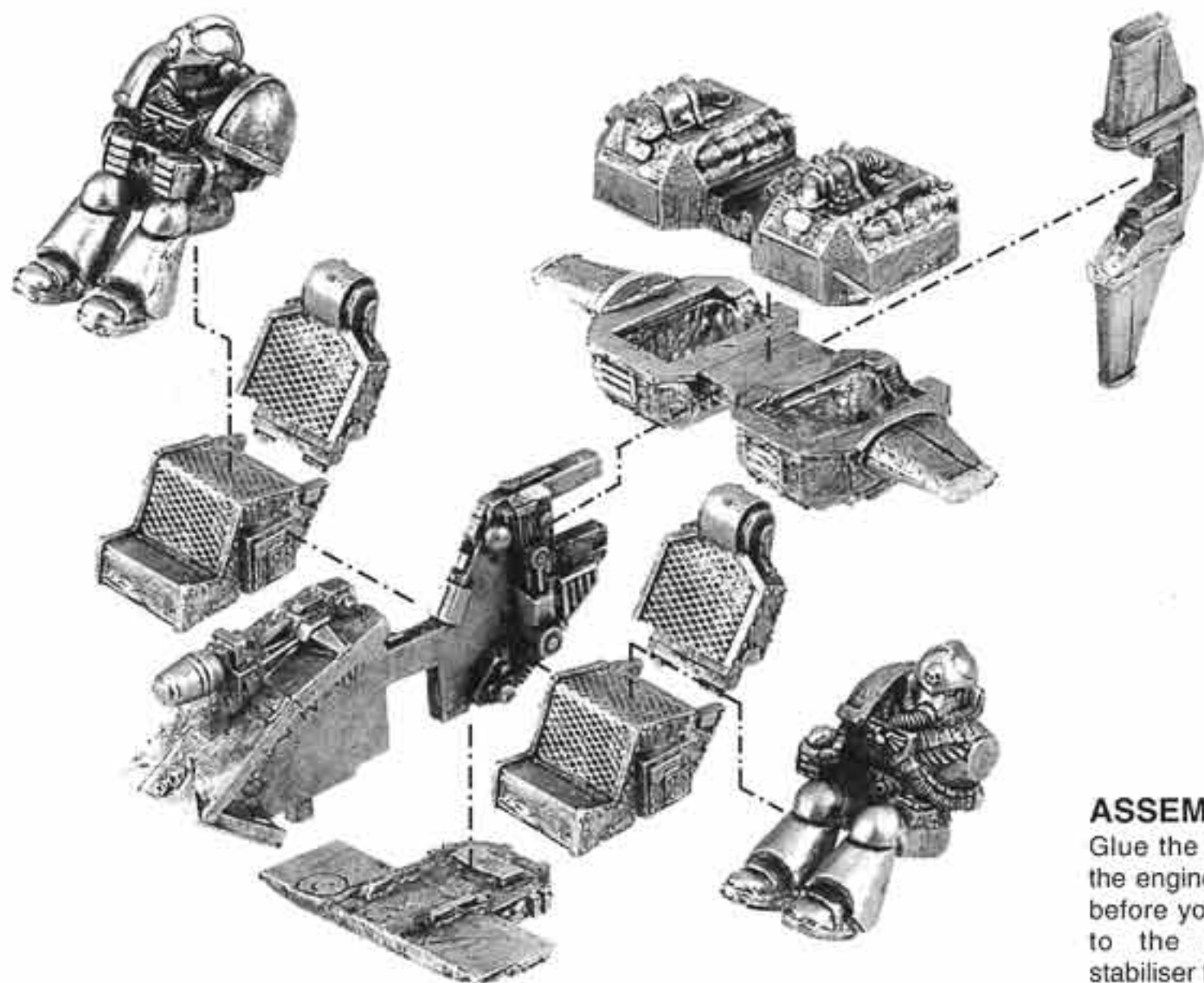

ASSEMBLY NOTE

Glue the two halves of the engine pod together before you attach them to the chassis and stabiliser fin.

ASSEMBLY STAGE 2



ASSEMBLY NOTE

To ensure that your model remains stable, carefully remove the pin at the top of the flying base with a sharp modelling knife, as shown above. Then glue your finished model to the base.

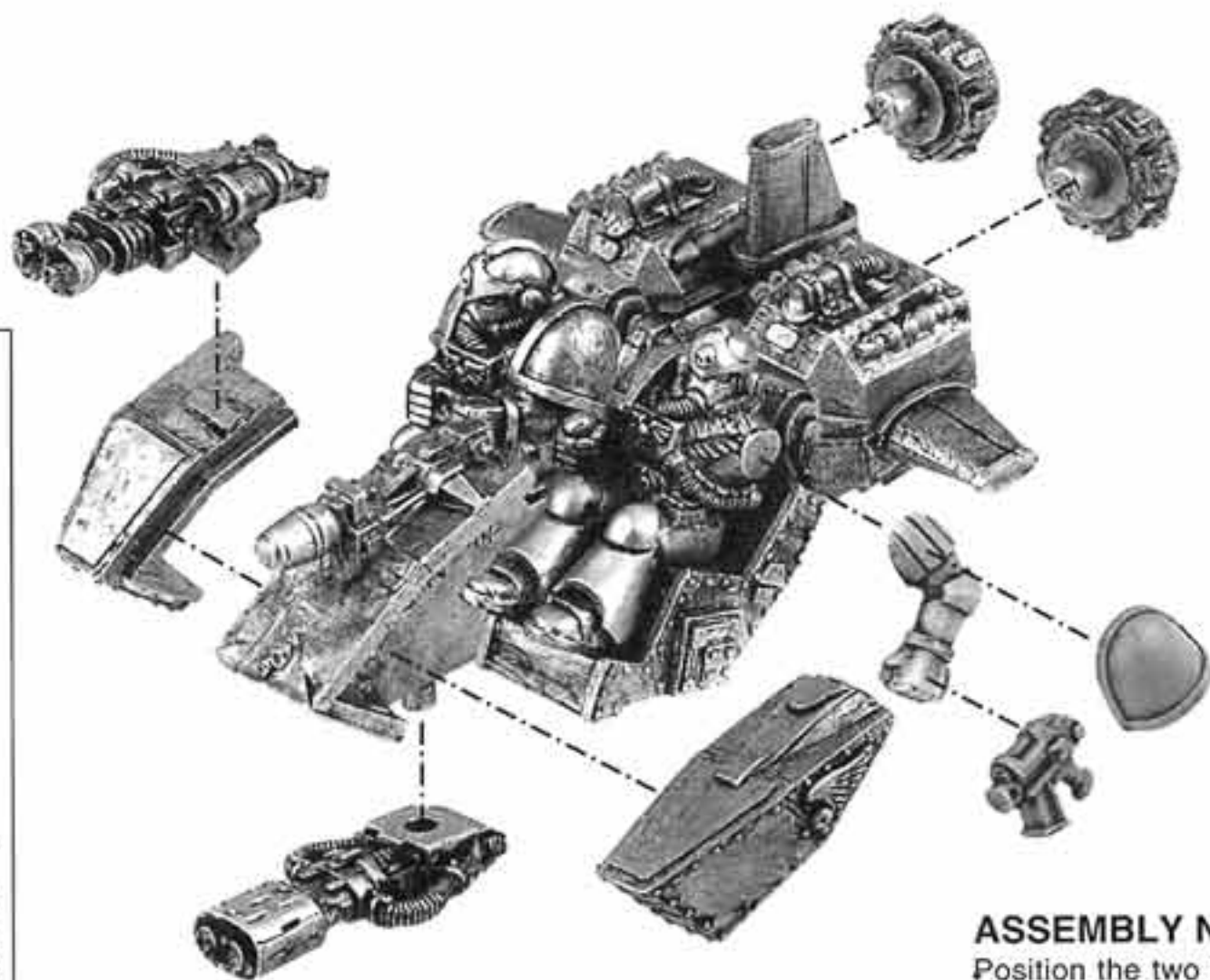

ASSEMBLY NOTE

Position the two Space Marine crew members onto your Land Speeder before you attach the fairings to your model.

SPACE WOLVES DREADNOUGHT

BJORN THE FELL-HANDED

THE COMPLETED BJORN THE FELL-HANDED

- CONSISTS OF:
 1 x SARCOPHAGUS 2
 1 x REAR BODY
 1 x LOWER BODY
 1 x LEGS
 2 x FOOT
 1 x BACK SECTION
 1 x ASSAULT CANNON
 1 x POWER CLAW ARM
 1 x POWER CLAW
 1 x AUTO LAUNCHER
 1 x BANNER POLE 2

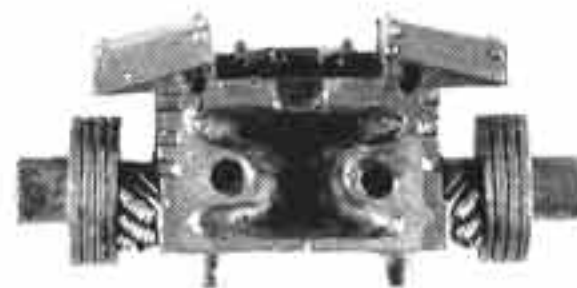

REAR BODY
0425/11



LOWER BODY
0425/2



LEGS
0425/9



BANNER POLE 2
0427/15

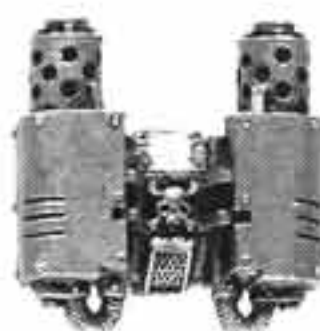

BACK SECTION
0425/4

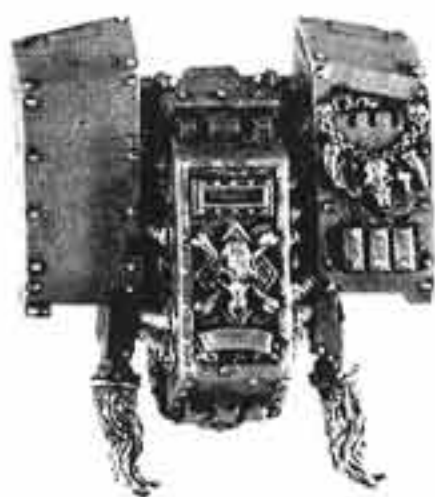

SARCOPHAGUS 2
0427/10

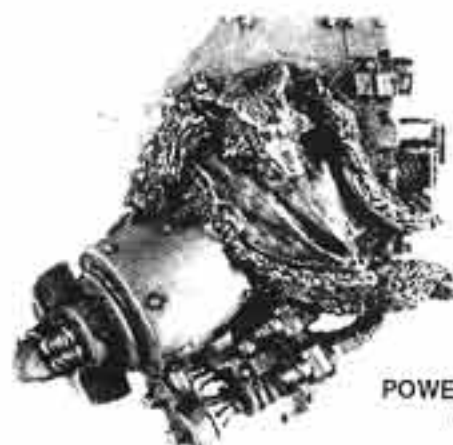

POWER CLAW ARM
0427/13

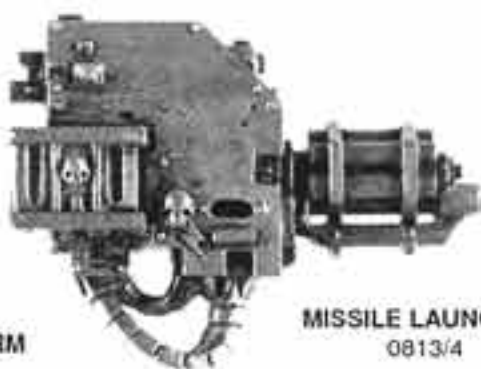

MISSILE LAUNCHER
0813/4

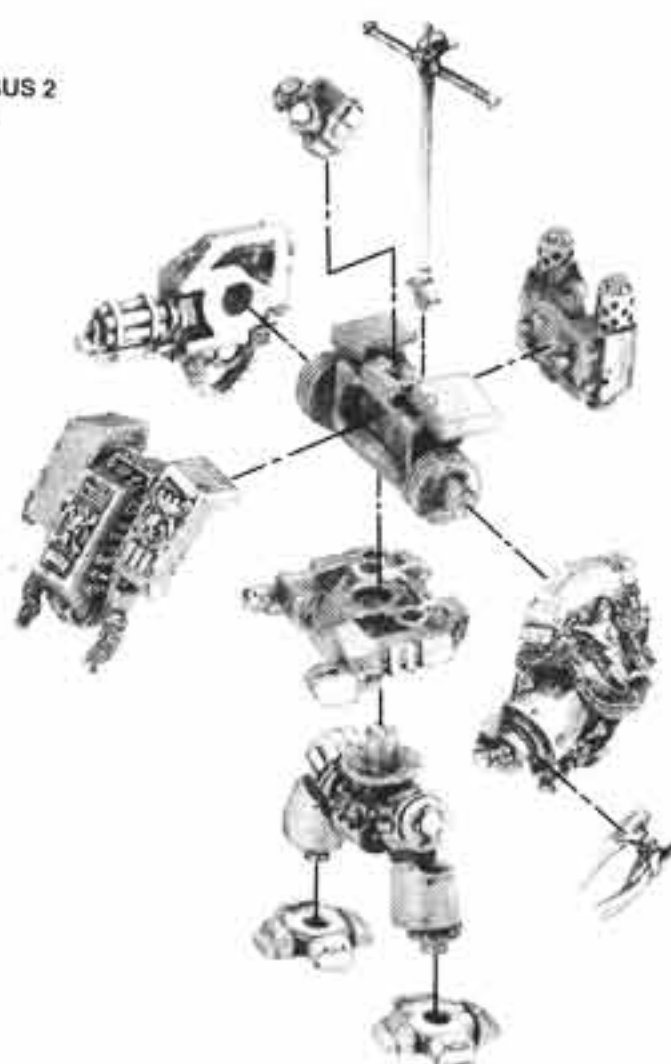

POWER CLAW
0427/14



FOOT
0425/8



AUTO LAUNCHER
0425/7

© Copyright Games Workshop Ltd 1993. All rights reserved.



CITADEL
MINIATURES

Designed by Jes Goodwin



SCOUTS

SPACE WOLVES WOLF SCOUT SERGEANTS



WOLF SCOUT SERGEANT 1
70005/1



WOLF SCOUT SERGEANT 2
70005/2



WOLF SCOUT SERGEANT 3
70005/3

THE COMPLETE
WOLF SCOUT SERGEANTS
CONSIST OF:
1 x WOLF SCOUT SERGEANT
1 x WOLF SCOUT BACKPACK



WOLF SCOUT
BACKPACK
70005/4

Designed by Jes Goodwin

SPACE MARINE SCOUTS



BOLTER 1
070295/11



BOLT PISTOL AND
COMBAT KNIFE 1
070295/10



SHURIKEN CATAPULT
AND BIONIC EYE
070295/4



BOLTER AND HORNED
SHOULDER PAD
070295/5



BOLT PISTOL AND
COMBAT KNIFE 3
070295/1



BOLT PISTOL AND
COMBAT KNIFE 4
070295/3



BOLT PISTOL AND
COMBAT KNIFE 5
070295/2



BOLT PISTOL
070295/13



LAS GUN AND
PUNCH DAGGER
070295/6



BOLT PISTOL AND
COMBAT KNIFE 2
070295/12



BOLT PISTOLS
070295/9



BOLTER 2
070295/8

Miniatures supplied unpainted. WARNING: This product contains lead which may be harmful if chewed or swallowed. Citadel Miniatures are not recommended for children under 15 years of age. © Copyright Games Workshop Ltd 1994. All rights reserved.



SPACE WOLVES



**WOLF LORD
RAGNAR BLACKMANE**



**RAGNAR BLACKMANE
WOLF LORD**
70008/1



**SPACE WOLF
BACK BANNER 1**
70008/2

**WOLF PRIEST
ULRIK THE SLAYER**



**ULRIK THE SLAYER
WOLF PRIEST**
70011/1



**SPACE WOLF
BACK BANNER 2**
70023/2

**RUNEPRIEST
NJAL STORMCALLER**



**SPACE WOLF
RUNEPRIEST**
70023/1

SPACE WOLF GREY HUNTERS

A SPACE WOLF SQUAD MAY INCLUDE OTHER MODELS FROM OUR SPACE MARINE RANGES



**GREY HUNTER
SPACE MARINE
SERGEANT**
0802/1



**GREY HUNTER 1
MK7 SPACE MARINE**
0802/2



**GREY HUNTER 2
MK7 SPACE MARINE**
0802/3



**GREY HUNTER 3
MK7 SPACE MARINE**
0802/4



**EXAMPLE OF A COMPLETED
SPACE WOLF GREY HUNTER**

THE GREY HUNTERS ARE SUPPLIED WITH A PLASTIC SPACE MARINE ARM SPRUE AND PLASTIC BOLTER AND BACKPACK SPRUE

IMPERIAL

ADEPTUS ARBITES



ADEPTUS ARBITES
WITH BOLTER
72400/2



ADEPTUS ARBITES
CHAMPION WITH SHOTGUN
72401/3



ADEPTUS ARBITES WITH
GRENADE LAUNCHER
74201/4



ADEPTUS ARBITES
WITH SHOTGUN
72400/1

Designed by Jes Goodwin

IMPERIAL GUARD

CATACHAN JUNGLE FIGHTERS



JUNGLE FIGHTER
WITH LASGUN 1
0437/2



JUNGLE FIGHTER
WITH LASGUN 2
0437/3



JUNGLE FIGHTER
SERGEANT 1
0437/4



JUNGLE FIGHTER
WITH MELTA-GUN
0437/6



JUNGLE FIGHTER
WITH LASGUN 3
0437/5



JUNGLE FIGHTER
WITH LASGUN 4
0437/1



JUNGLE FIGHTER
MISSILE LOADER
0437/7



JUNGLE FIGHTER
WITH MISSILE LAUNCHER
0437/8



MISSILE
LAUNCHER
STAND
0437/10



MISSILE LAUNCHER
0437/9



EXAMPLE OF COMPLETED JUNGLE FIGHTER WITH
MISSILE LAUNCHER

© Copyright Games Workshop Ltd 1994. All rights reserved.



IMPERIAL

IMPERIAL PSYKERS



PSYKER 1
72410/3



PSYKER 2
72410/1



PSYKER 3
72410/2

Designed by Jes Goodwin

OGRYNS



HEAD 1
72420/3



HEAD 2
72420/1



HEAD 3
72420/2



TORSO 1
72420/6



TORSO 2
72420/7



TORSO 3
72420/10



GUN 1
72420/9



GUN 2
72420/8



GUN 3
72420/11



LEGS 1
72420/4



LEGS 2
72420/5

THE COMPLETED OGRYN
CONSIST OF:
1 x HEAD
1 x TORSO
1 x GUN
1 x LEGS
PLEASE NOTE TORSO 3
WILL ONLY FIT WITH GUN 3



EXAMPLES OF COMPLETED OGRYNS

Designed by Michael Perry

© Copyright Games Workshop Ltd. 1998. All rights reserved.



ELDAR

AVATAR



EXAMPLE OF THE COMPLETED ELDAR AVATAR

BLOODY HAND
0430/4



RIGHT ARM AND SWORD
0430/3



THE COMPLETED ELDAR AVATAR
CONSISTS OF:
1 x AVATAR TORSO
1 x AVATAR LEGS
1 x AVATAR MANE
1 x BLOODY HAND
1 x RIGHT ARM AND SWORD



AVATAR MANE
0430/5



AVATAR TORSO
0430/2



AVATAR LEGS
0430/1



ELDRAD ULTHRAN – FARSEER OF ULTHWE



ELDRAD ULTHRAN
71500/1



ELDAR

FARSEER



FARSEER
071604/3

ELDRAD ULTHRAN – FARSEER OF ULTHWE



ELDRAD ULTHRAN
71500/1

WARLOCKS



WARLOCK AND
FORCE ROD 1
071604/4



WARLOCK AND
FORCE ROD 2
071604/2



WARLOCK AND
SINGING SPEAR
71604/7



WARLOCK AND
WITCH BLADE 1
071604/5



WARLOCK AND
WITCH BLADE 2
071604/1



WARLOCK AND
WITCH BLADE 3
71604/6

ELDAR

KARANDRAS – THE SHADOW HUNTER



KARANDRAS BODY
71501/1

THE COMPLETED KARANDRAS
CONSISTS OF:
1 x KARANDRAS BODY
1 x KARANDRAS HEAD



KARANDRAS HEAD
71501/2



ASURMEN – THE HAND OF ASURYAN



ASURMEN BODY
71503/1

THE COMPLETED ASURMEN CONSISTS OF:
1 x ASURMEN BODY
1 x ASURMEN BANNER POLE



ASURMEN
BANNER POLE
71503/2



FUEGAN – THE BURNING LANCE



FUEGAN
71502/1

THE COMPLETED FUEGAN
CONSISTS OF:
1 x FUEGAN BODY
1 x FIRE AXE



FIRE AXE
71502/2



EXAMPLE OF COMPLETED
FUEGAN – THE BURNING LANCE

ELDAR

MAUGAN-RA – THE HARVESTER OF SOULS



MAUGAN-RA
BODY
71504/1



MAUGETAR
71504/2



MAUGAN-RA
BACKPACK
71504/3

THE COMPLETED MAUGAN-RA CONSISTS OF:
1 x MAUGAN-RA BODY
1 x MAUGAN-RA BACKPACK
1 x MAUGETAR



EXAMPLE OF COMPLETED
MAUGAN-RA

JAIN ZAR – THE STORM OF SILENCE



JAIN ZAR
71505/1



LEFT ARM AND BLADE
OF DESTRUCTION
71505/2



RIGHT HAND AND
SILENT DEATH
71505/3

THE COMPLETED JAIN ZAR
CONSISTS OF:
1 x JAIN ZAR BODY
1 x LEFT ARM AND BLADE OF
DESTRUCTION
1 x RIGHT HAND AND SILENT DEATH



EXAMPLE OF COMPLETED JAIN ZAR

BAHARROTH – THE CRY OF THE WIND



BAHARROTH BODY
71506/1



SWOOPING HAWK
EXARCH WINGS
71570/6

THE COMPLETED BAHARROTH
CONSISTS OF:
1 x BAHARROTH BODY
1 x SWOOPING HAWK EXARCH WINGS



EXAMPLE OF COMPLETED
SWOOPING HAWK EXARCH



ELDAR

ELDAR SHRIEKER JETBIKE

- A COMPLETE ELDAR SHRIEKER JETBIKE CONSISTS OF:
- 1 x PLASTIC ELDAR JETBIKE SPRUE
 - 1 x METAL SHRIEKER CANNON
 - 1 x METAL JETBIKE RIDER TORSO
 - 1 x PLASTIC FLYING BASE
 - 1 x PLASTIC ELDAR ARM SPRUE
 - 1 x PLASTIC ELDAR WEAPON SPRUE



SHRIEKER CANNON
00438/2



JETBIKE RIDER TORSO
00438/1

ELDAR JETBIKE

- A COMPLETE ELDAR JETBIKE CONSISTS OF:
- 1 x PLASTIC ELDAR JETBIKE SPRUE
 - 1 x PLASTIC FLYING BASE
 - 1 x PLASTIC ELDAR ARM SPRUE
 - 1 x PLASTIC ELDAR WEAPON SPRUE



THESE MODEL KITS INCLUDE A CITADEL TRANSFER SHEET AND FULL COLOUR ADHESIVE BANNERS. THE TRANSFER SHEET INCLUDES ALL THE MARKINGS NEEDED FOR SEVERAL DIFFERENT CRAFTWORLDS.

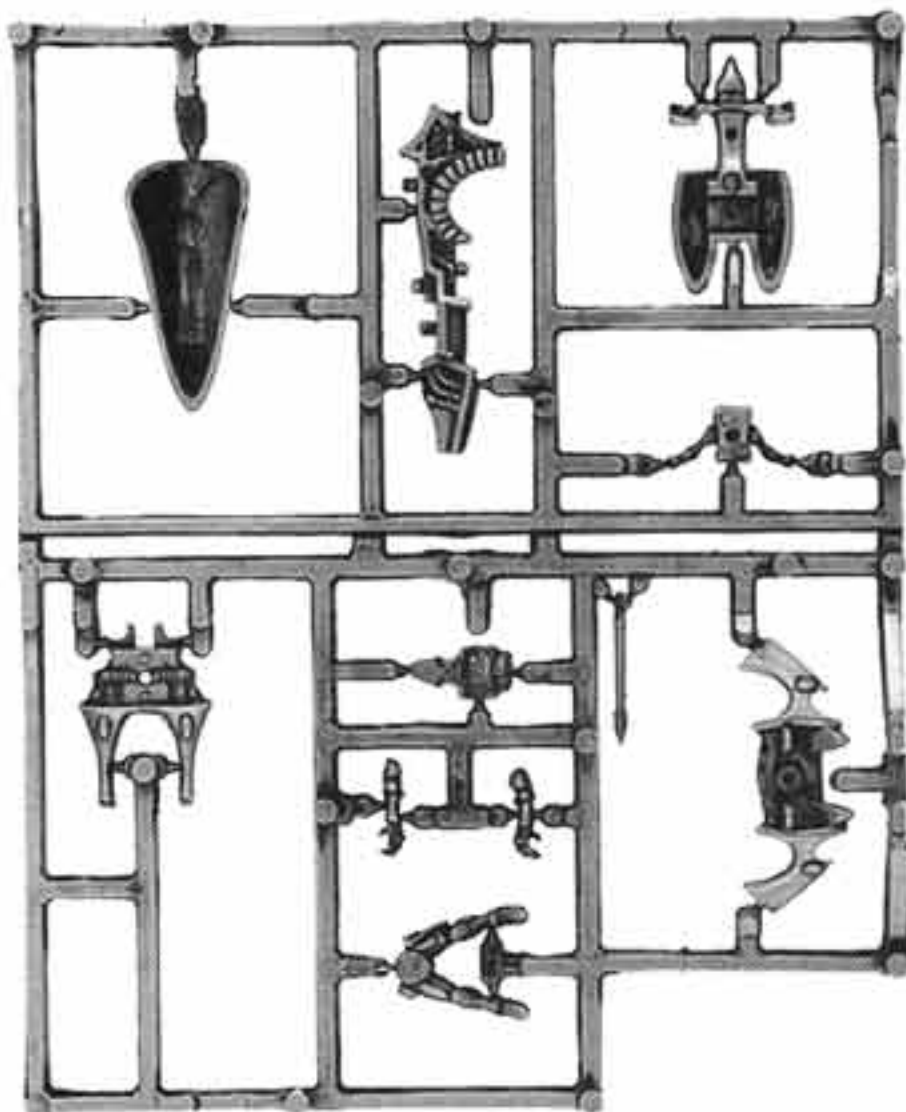
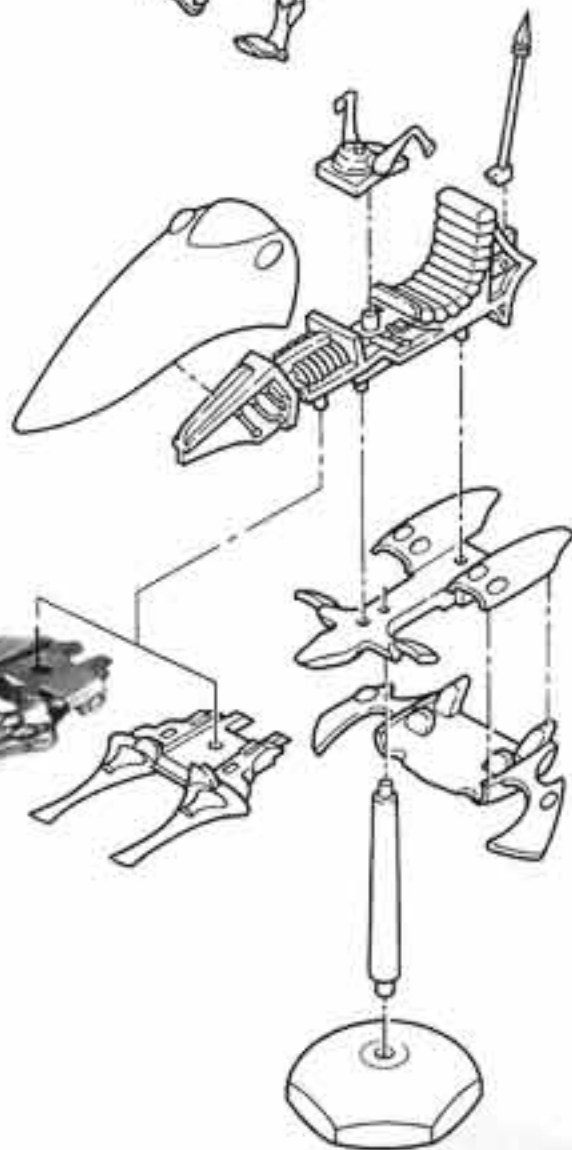
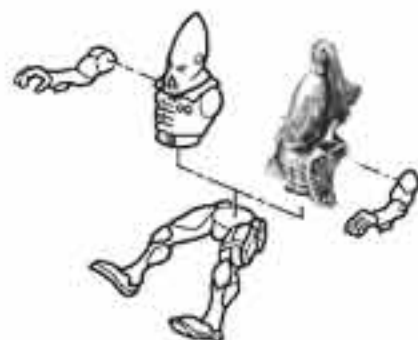

ELDAR JETBIKE SPRUE 102784 (SHOWN AT 50% OF ACTUAL SIZE)

NOT SUITABLE FOR CHILDREN UNDER 36 MONTHS DUE TO SMALL PARTS AND ESSENTIAL POINTED COMPONENTS. THIS KIT IS SUPPLIED UNPAINTED. THE PLASTIC PARTS NEED TO BE ASSEMBLED USING POLYSTYRENE CEMENT.

ELDAR

ELDAR DREADNOUGHT

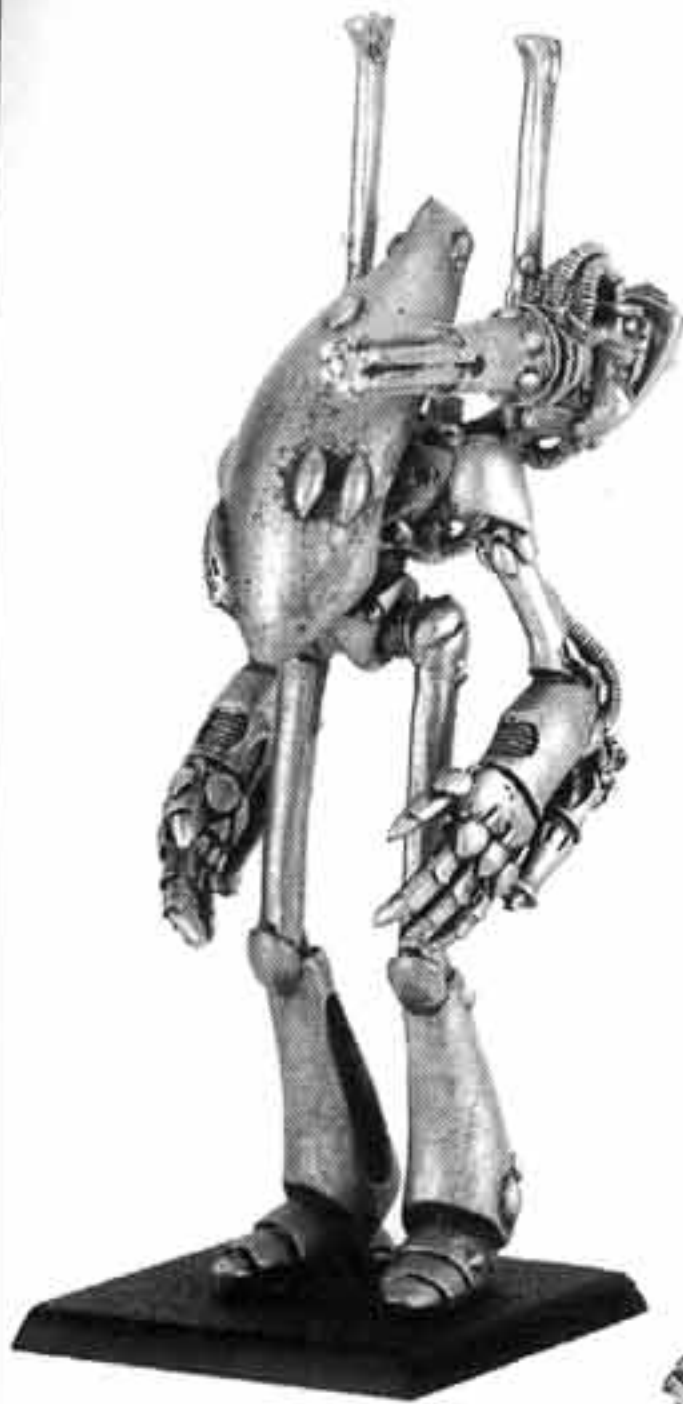

EXAMPLE OF COMPLETED ELDAR DREADNOUGHT

THE COMPLETED ELDAR DREADNOUGHT CONSISTS OF:

- 1 x HEAD
- 1 x POWER PLANT
- 1 x TORSO
- 1 x LEFT LEG
- 1 x RIGHT LEG
- 1 x LEFT ARM
- 1 x RIGHT ARM
- 1 x WEAPON

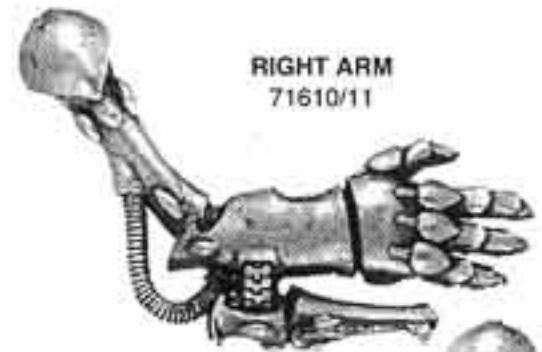

RIGHT ARM
71610/11



LEFT ARM
71610/12



D - CANNON
71610/10



SCATTER LASER
71610/1

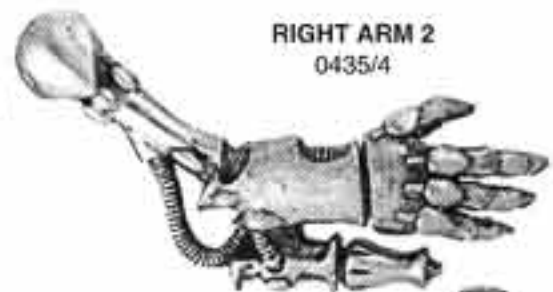

RIGHT ARM 2
0435/4



MISSILE LAUNCHER
71610/3



LEFT ARM 2
0435/5



LAS CANNON
71610/2



TORSO
71610/1



HEAVY PLASMA GUN
71610/4



POWER PLANT
0435/2



LEFT LEG
0435/8



HEAD
043.5/3



RIGHT LEG
0435/7



ELDAR

GUN CREW



GUNNER WITH
SHURIKEN CATAPULT
71610/9



GUNNER WITH SHURIKEN
CATAPULT AND HELMET
71610/5



SPOTTER WITH
HELMET
71610/8



SPOTTER WITH
GOGGLES
71610/7

ANTI-GRAV WEAPONS PLATFORM



EXAMPLE OF COMPLETED
ANTI-GRAV WEAPONS PLATFORM



ANTI-GRAV PLATFORM
71610/6

THE COMPLETED ELDAR
ANTI-GRAV WEAPONS
PLATFORM CONSISTS OF:
1 x ANTI-GRAV PLATFORM
1 x WEAPON SHIELD
1 x HEAVY WEAPON
1 x GUNNER
1 x SPOTTER



D - CANNON
071617/2



WEAPON SHIELD
0432/12



SCATTER LASER
71610/1



HEAVY PLASMA GUN
71610/4



LAS CANNON
71610/2

ELDAR

WAR WALKER



EXAMPLE OF COMPLETED ELDAR WAR WALKER



SCATTER LASER
71610/1



LAS CANNON
71610/2



MISSILE LAUNCHER
71610/3



HEAVY PLASMA GUN
71610/4



LEFT LEG
0432/14

RIGHT LEG
0432/13



TORSO
0432/1



WEAPON SHIELD
0432/12



POWER PLANT
0432/2



WAR WALKER
GUARDIAN
0432/5

THE COMPLETED ELDAR WAR WALKER CONSISTS OF:

- 1 x WAR WALKER GUARDIAN
- 1 x TORSO
- 1 x POWER PLANT
- 2 x WEAPON SHIELD
- 2 x WEAPONS
- 1 x LEFT LEG
- 1 x RIGHT LEG

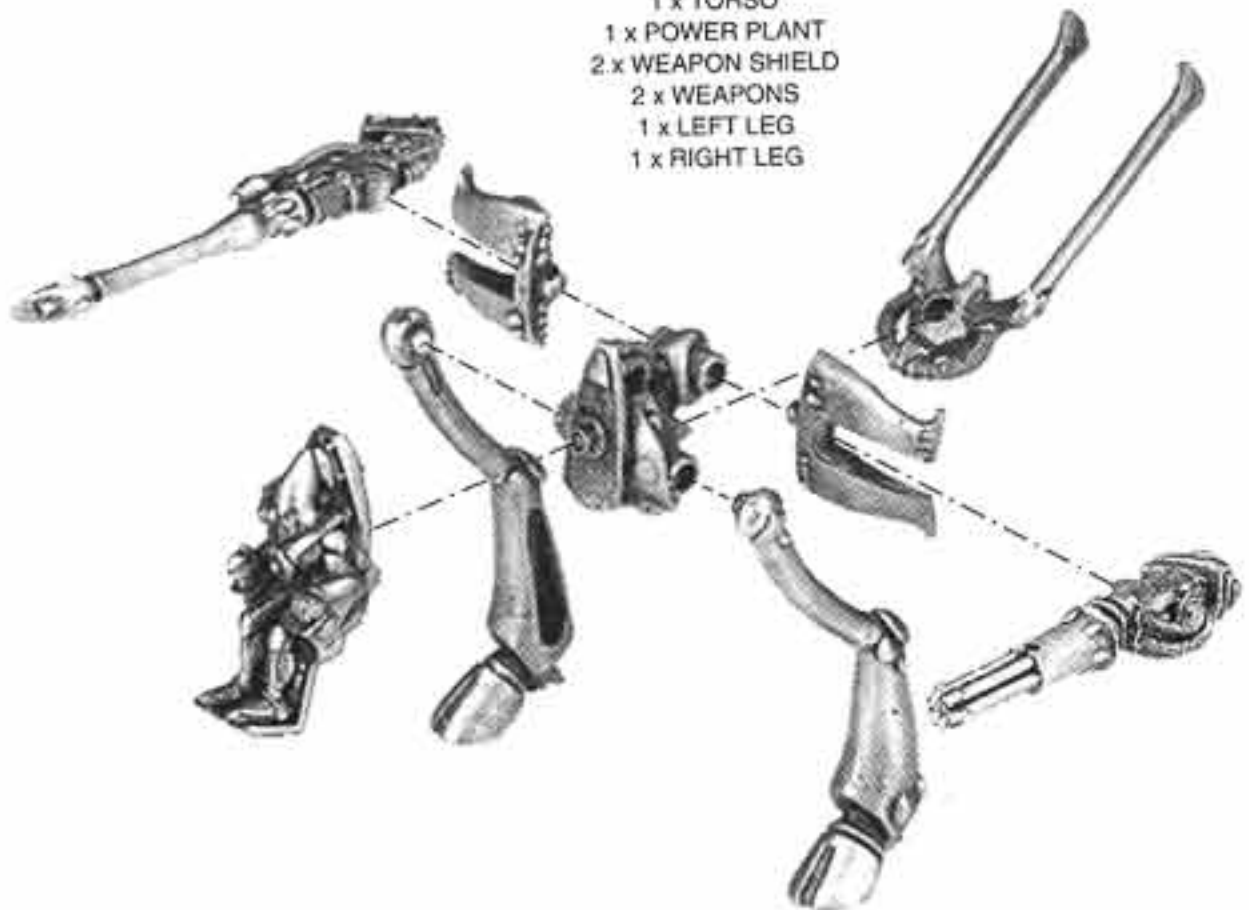

Manufactured and distributed by Citadel Miniatures, Warhammer. This product contains small parts which may be harmful if swallowed.
 © Copyright Games Workshop Ltd 1994. All rights reserved.



CITADEL
MINIATURES

Designed by Jes Goodwin

ELDAR

WRAITHGUARD

A COMPLETE ELDAR WRAITHGUARD
CONSISTS OF:
1 x WRAITHGUARD BODY
1 x WRAITHGUARD HEAD



WRAITHGUARD HEAD 1
71510/1



WRAITHGUARD HEAD 2
71510/3



WRAITHGUARD HEAD 3
71510/5



WRAITHGUARD BODY 1
71510/4



WRAITHGUARD BODY 2
71510/2



WRAITHGUARD BODY 3
71510/6



EXAMPLES OF COMPLETED ELDAR WRAITHGUARD



ELDAR

WARP SPIDER ASPECT WARRIORS



WARP SPIDER 1
71635/1



WARP SPIDER 2
71635/2



WARP SPIDER 3
71635/3

WARP SPIDER EXARCH



EXAMPLE OF COMPLETED
WARP SPIDER EXARCH



WARP SPIDER
EXARCH BODY
71571/1

THE COMPLETED WARP SPIDER
EXARCH CONSISTS OF:
1 x WARP SPIDER EXARCH BODY
1 x WARP SPIDER EXARCH CARAPACE
1 x WARP SPIDER DEATH SPINNER



WARP SPIDER
EXARCH CARAPACE
71571/2



WARP SPIDER
DEATH SPINNER
71571/3



ELDAR GUARDIANS



GUARDIAN 1
RTB17/3



GUARDIAN 2
71584/21



GUARDIAN 3
71584/20



GUARDIAN 4
71584/30



GUARDIAN 5
RTB17/4



GUARDIAN 6
71584/19



GUARDIAN 7
71584/25



GUARDIAN 8
71584/18



GUARDIAN 9
71584/26



GUARDIAN 10
71584/23



GUARDIAN 11
71584/28



GUARDIAN 12
RTB17/1



GUARDIAN 13
71584/22



GUARDIAN 14
71584/29



GUARDIAN 15
71584/17



EXAMPLES OF COMPLETED ELDAR GUARDIANS

THESE MODELS ARE SUPPLIED WITH AN ELDAR ARMS SPRUE AND AN ELDAR WEAPONS SPRUE AS STANDARD

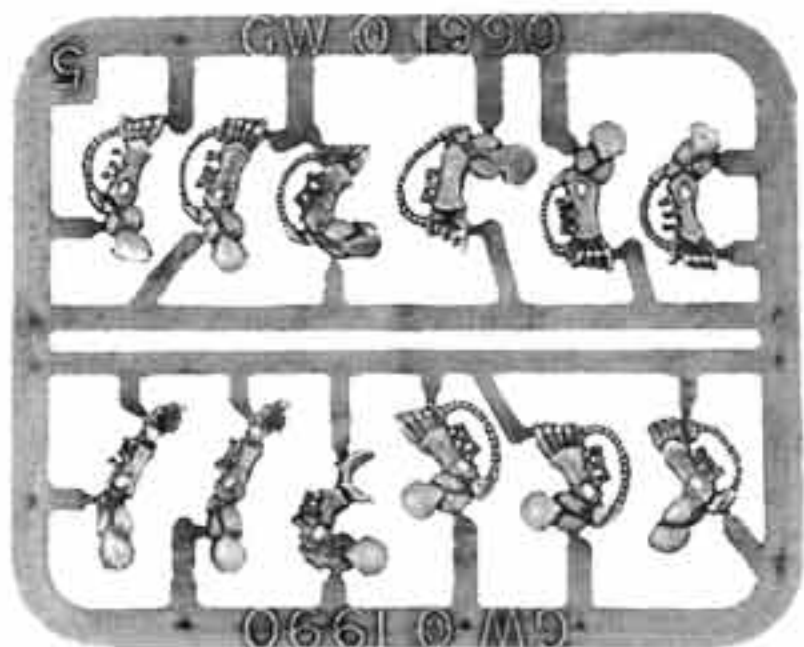

ELDAR ARMS SPRUE 100825



ELDAR WEAPONS SPRUE 100813

ELDAR

HOWLING BANSHEES



HOWLING BANSHEE 2
71620/9



HOWLING BANSHEE 1
71620/1



HOWLING BANSHEE 3
71620/15



HOWLING BANSHEE 4
71620/20

SWOOPING HAWKS

THE SWOOPING HAWK IS SUPPLIED WITH HAWK WINGS AS STANDARD



SWOOPING HAWK 1
71621/3



SWOOPING HAWK 2
71621/11



SWOOPING HAWK 3
71621/17



SWOOPING HAWK 4
71621/22



HAWK WINGS
71621/4

THE COMPLETE SWOOPING HAWK CONSISTS OF:
1 x SWOOPING HAWK
1 x HAWK WINGS



SWOOPING HAWK EXARCH
WITH LASBLASTER
071572/5

THE SWOOPING HAWK EXARCH IS
SUPPLIED WITH EXARCH WINGS
AS STANDARD



EXARCH WINGS
071572/6



HOWLING BANSHEE EXARCH
WITH POWER AXE
071572/3

Manufactures copyright unexpired. WARNING: This product contains lead which may be harmful if chewed or swallowed. Citadel Miniatures is a registered trademark of Games Workshop Ltd 1994. All rights reserved.



ASPECT WARRIORS

WARP SPIDERS



WARP SPIDER 1
71635/1



WARP SPIDER 2
71635/2



WARP SPIDER 3
71635/3

SWOOPING HAWKS

THE SWOOPING HAWK IS SUPPLIED WITH HAWK WINGS AS STANDARD



SWOOPING HAWK 1
71621/3



SWOOPING HAWK 2
71621/11



SWOOPING HAWK 3
71621/17



SWOOPING HAWK 4
71621/22



HAWK WINGS
71621/4

THE COMPLETE SWOOPING
HAWK CONSISTS OF:
1 x SWOOPING HAWK
1 x HAWK WINGS

DIRE AVENGERS



DIRE AVENGER 1
71624/5



DIRE AVENGER 2
71624/12



DIRE AVENGER 3
71624/18



DIRE AVENGER 4
71624/23

ASPECT WARRIORS

DARK REAPERS



DARK REAPER 1
071560/7



DARK REAPER 2
071560/14



DARK REAPER 3
071560/25



MISSILE LAUNCHER
071560/8

HOWLING BANSHEES



HOWLING BANSHEE 2
71620/9



HOWLING BANSHEE 1
71620/1



HOWLING BANSHEE 3
71620/15



HOWLING BANSHEE 4
71620/20

STRIKING SCORPIONS



STRIKING SCORPION 4
71623/21



STRIKING SCORPION 1
71623/2



STRIKING SCORPION 2
71623/10



STRIKING SCORPION 3
71623/16

FIRE DRAGONS



FIRE DRAGON 1
71622/6



FIRE DRAGON 2
71622/13



FIRE DRAGON 3
71622/19



FIRE DRAGON 4
71622/24

Advertisement supplied unpainted. WARNING: This product contains lead which may be harmful if swallowed. © Copyright Games Workshop Ltd 1994. All rights reserved.





ORK BOSSES

THESE MODELS, EXCEPT THOSE MARKED WITH AN ASTERISK, ARE ALL SUPPLIED WITH AN ORK ARMS SPRUE AND AN ORK WEAPONS SPRUE AS STANDARD



DEATH SKULL
070669/6



GRETCHIN
STANDARD BEARER*
070794/2



WARLORD
GHAZGHKULL THRAKA*
070794/1



SNAKE BITE 2
070561/7



BAD MOON 1*
070669/4



GOFF 3
070561/8



EVIL SUNZ 2
070561/10



BLOOD AXE 1*
070669/1



BAD MOON 2
070669/11



GOFF 1
070669/3



EVIL SUNZ 1
070669/5



BLOOD AXE 2
070561/9



EXAMPLES OF THE COMPLETED ORK BOSSES

Minatures supplied unpainted. WARNING: This product contains lead which may be harmful if chewed or swallowed. Citadel Miniatures are not recommended for children under 14 years of age. © Copyright Games Workshop Ltd 1994. All rights reserved.



WEIRDBOYZ

WEIRDBOYZ



WEIRDBOY 2
070657/4



WARHEAD WEIRDBOY
070683/15



EVIL SUNZ
070620/4



BAD MOON
070620/6



WEIRDBOY 1
070657/5



BLOOD AXE
070620/8



DEATH SKULL
070620/5



GOFF
070620/7



SNAKE BITE
070620/9

MINDERZ



MINDERZ FIRING WEIRDBOY
070657/2



MINDER HOLDING COPPER STAFF
070605/19



MINDERZ HOLDING WEIRDBOY
070657/1

ALL OF THESE MODELS, EXCEPT THE GOFF, ARE SUPPLIED WITH AN ORK ARMS SPRUE AND AN ORK WEAPONS SPRUE AS STANDARD



FREEBOOTER MINDER
070657/3



MINDER 1
070605/25

EXAMPLES OF THE COMPLETED ORK WEIRDBOYZ



ORKS

GOFF NOBS



GOFF NOB 1
70801/5

GOFF NOB 2
70801/2

GOFF NOB 3
70801/1

GOFF NOB 4
70801/3

GOFF NOB 5
70801/4

GOFF SKARBOYZ



GOFF SKARBOYZ 1
70800/3

GOFF SKARBOYZ 2
70800/4

GOFF SKARBOYZ 3
70800/5

GOFF SKARBOYZ 4
70800/1

GOFF SKARBOYZ 5
70800/2

THESE MODELS ARE SUPPLIED WITH PLASTIC ORK ARMS AND WEAPONS SPRUES



EXAMPLES OF COMPLETED GOFF NOBS AND SKARBOYZ

Minatures supplied unpainted. WARNING. This product contains lead which may be harmful if chewed or swallowed. Citadel Miniatures are not recommended for children under 14 years of age. © Copyright Games Workshop Ltd 1993. All rights reserved.

ORKS

TRAKTOR KANNON

THE COMPLETE TRAKTOR KANNON
CONSISTS OF:

- 1 x GRETCHIN WITH SCREWDRIVER
- 1 x TRAKTOR KANNON MUZZLE
- 1 x TRAKTOR KANNON BARREL
- 1 x GRETCHIN WITH WRENCH
- 1 x TRAKTOR KANNON BASE
- 1 x CONTROL PANEL
- 1 x CHASSIS
- 2 x WHEEL



EXAMPLE OF COMPLETED TRAKTOR KANNON AND CREW



TRAKTOR KANNON
CONTROL PANEL
70810/5



TRAKTOR KANNON
MUZZLE
70810/4



TRAKTOR KANNON
BARREL
70810/6



TRAKTOR KANNON
BASE
70810/3

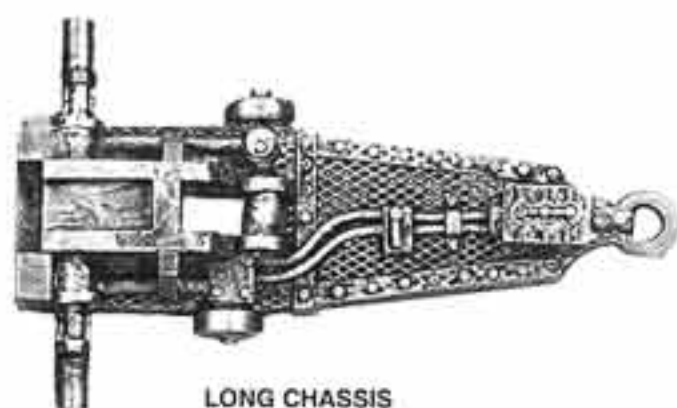

LONG CHASSIS
70810/7



WHEEL
70805/6



GRETCHIN WITH
WRENCH
70811/3



GRETCHIN WITH
OIL SQUIG
70810/2

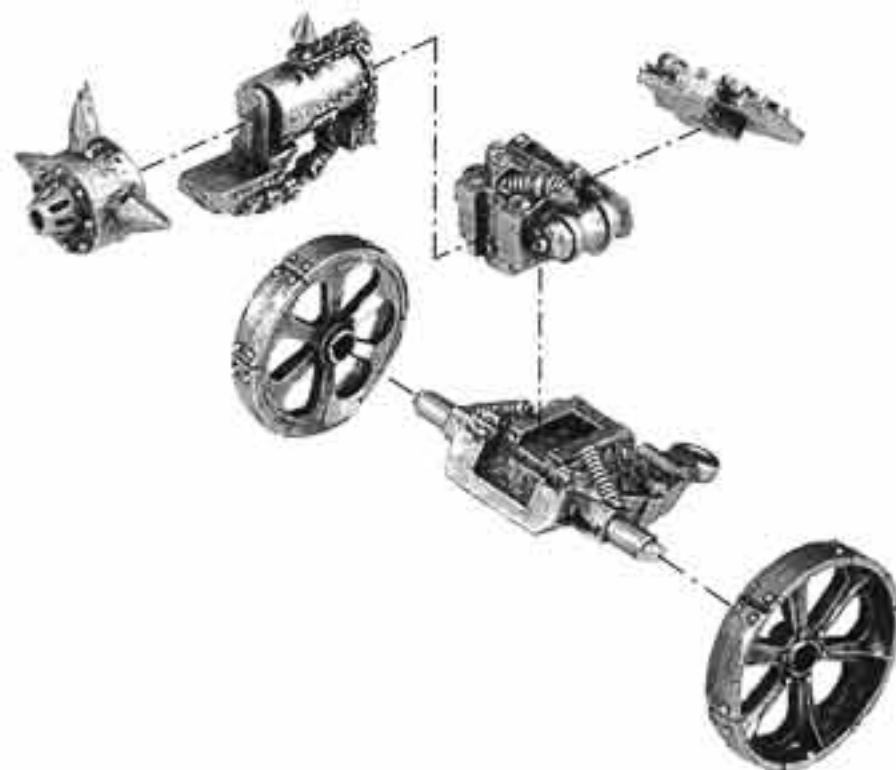

GRETCHIN

GRETCHIN ASSISTANTS



GRETCHIN ASSISTANT 2
70559/40



GRETCHIN ASSISTANT 3
70559/44



GRETCHIN ASSISTANT 4
70559/42



GRETCHIN ASSISTANT 6
70559/41



GRETCHIN ASSISTANT 5
70559/43



GRETCHIN ASSISTANT 1
70559/45

Designed by Alan Perry

GRETCHIN WITH AUTOGUNS



GRETCHIN 1
70559/31



GRETCHIN 7
70559/30



GRETCHIN 3
70559/32



GRETCHIN 4
70559/27



GRETCHIN 5
70559/29



GRETCHIN 6
70559/26



GRETCHIN 2
70559/33



GRETCHIN 8
70559/28

GRETCHIN WITH AUTOPISTOLS AND SWORDS



GRETCHIN 14
70559/36



GRETCHIN 11
70559/38



GRETCHIN 12
70559/39



GRETCHIN 9
70559/37



GRETCHIN 13
70559/34



GRETCHIN 10
70559/35

Minatures supplied unpainted. WARNING: This product contains lead which may be harmful if chewed or swallowed. Citadel Miniatures are not recommended for children under 14 years of age. © Copyright Games Workshop Ltd 1994. All rights reserved.



ORKS

PULSA ROKKIT



EXAMPLE OF COMPLETED PULSA ROKKIT



ROKKIT TOP
70808/5



ROKKIT BOTTOM
70808/4



RAMP SUPPORT
70808/8

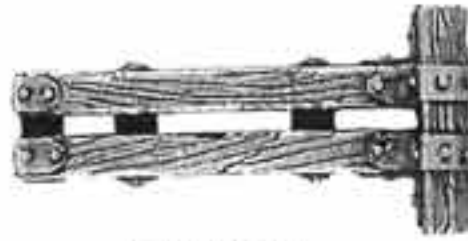

LAUNCH RAMP
70808/7



ROKKIT ENGINE
70808/6



GRETCHIN WITH
SCREWDRIVER
70810/1

THE COMPLETE PULSA ROKKIT

- CONSISTS OF:
 1 x ROKKIT TOP
 1 x ROKKIT BOTTOM
 1 x ROKKIT ENGINE
 1 x LAUNCH RAMP
 1 x RAMP SUPPORT
 2 x GRETCHIN KREW



GRETCHIN WITH
OIL SQUIG
70810/2



GRETCHIN WITH SPANNER
70805/2



GRETCHIN WITH SHELLS
70805/1



GRETCHIN WITH
WRENCH
70811/3



GRETCHIN WITH
TOOLBOX
70808/9



GRETCHIN WITH
HAMMER
70811/4

ORKS

STORMBOYZ

THESE MODELS ARE SUPPLIED WITH A PLASTIC ORK ARMS SPRUE AND WEAPONS SPRUE AS STANDARD



STORMBOY 1
0436/3



STORMBOY 2
0436/4



STORMBOY 3
70809/1



STORMBOY 4
70809/3



STORMBOY 5
70809/2



STORMBOY DRILLBOSS
0436/2



STORMBOY
JUMP PACK
0436/1

A COMPLETE STORMBOY
CONSISTS OF:
1 x STORMBOY
1 x STORMBOY JUMP PACK

EXAMPLES OF COMPLETED ORK STORMBOYZ



BLOODAXE KOMMANDOS



BLOODAXE KOMMANDO 1
70807/2



BLOODAXE KOMMANDO 2
70807/1



BLOODAXE KOMMANDO 4
70807/4



BLOODAXE KOMMANDO 5
70807/5



BLOODAXE KOMMANDO 6
70807/6



BLOODAXE KOMMANDO 3
70807/3

Minatures supplied unpainted. WARNING: This product contains lead which may be harmful if chewed or swallowed. Citadel Miniatures are not recommended for children under 14 years of age. © Copyright Games Workshop Ltd 1994. All rights reserved.

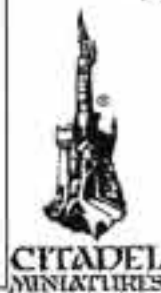

Designed by Alan Perry

ORKS

SMASHA GUN

THE COMPLETE SMASHA GUN CONSISTS OF:

- 1 x SMASHA GUN TOP
- 1 x SMASHA GUN SUPPORT
- 1 x CHASSIS
- 2 x WHEEL
- 1 x GRETCHIN WITH HAMMER
- 1 x GRETCHIN WITH WRENCH

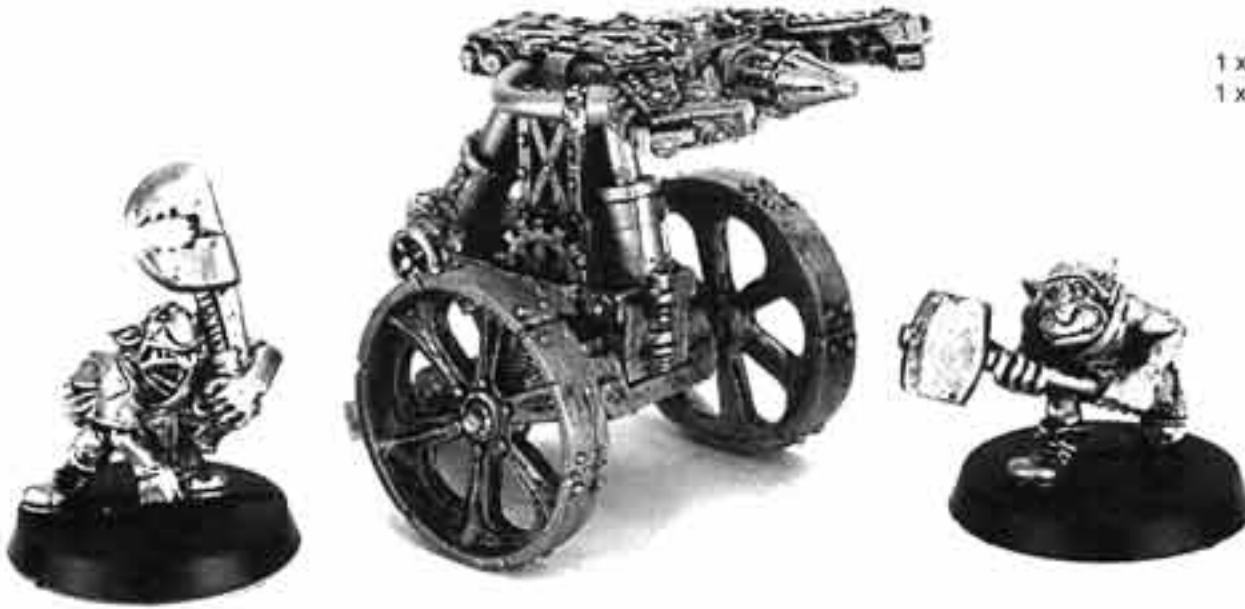

EXAMPLE OF COMPLETED SMASHA GUN

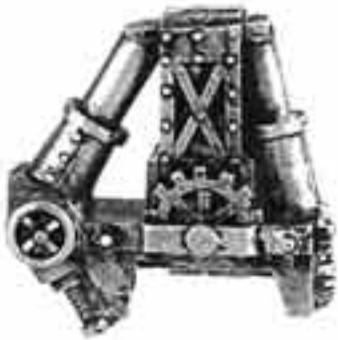

SMASHA GUN SUPPORT
70811/2



SMASHA GUN TOP
70811/1



WHEEL
70805/6

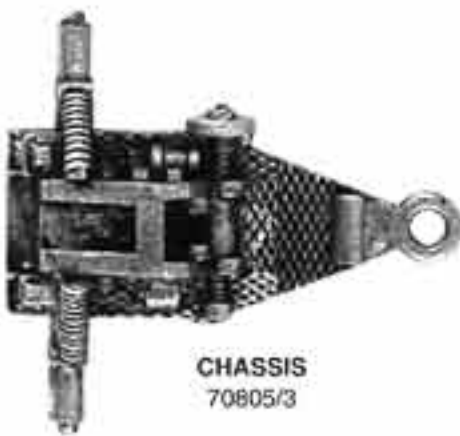

CHASSIS
70805/3

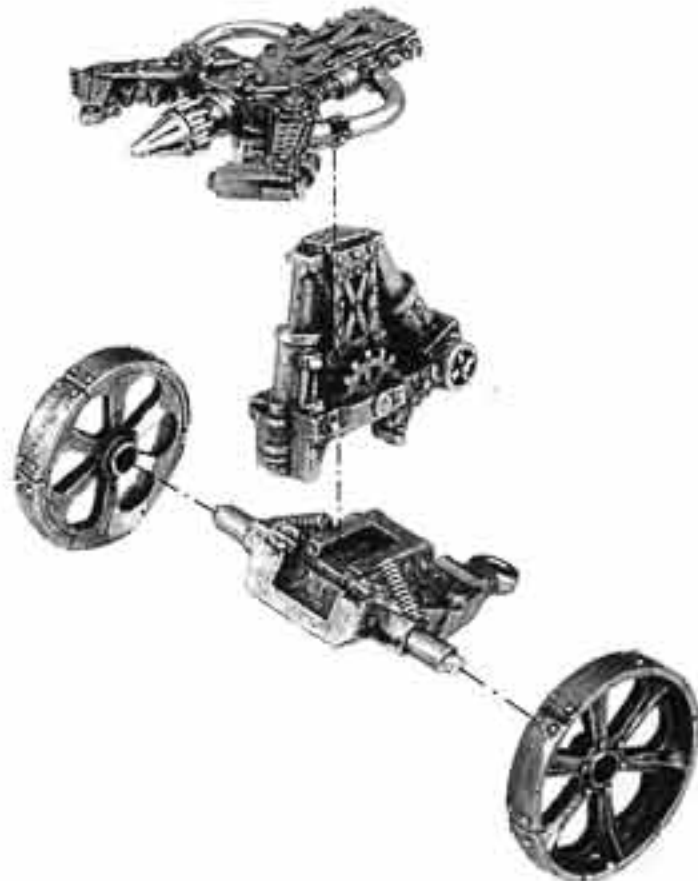

GRETCHIN WITH
HAMMER
70811/4



GRETCHIN
WITH WRENCH
70811/3

ORKS

ZODGROD WORTSNAGGA

THE COMPLETE ZODGROD
WORTSNAGGA CONSISTS OF:
1 x ZODGROD BODY
1 x ZODGROD'S BANNER



ZODGROD WORTSNAGGA
70806/1



ZODGROD'S BANNER
70806/2



EXAMPLE OF COMPLETED
ZODGROD WORTSNAGGA



BLOODAXE
KOMMANDO 1
70807/2



BLOODAXE
KOMMANDO 3
70807/3

BLOODAXE KOMMANDOS



BLOODAXE
KOMMANDO 2
70807/1



Miniatures supplied unpainted. WARNING: This product contains lead which may be harmful if chewed or swallowed. Citadel Miniatures is a registered trademark of Games Workshop Ltd. © Copyright Games Workshop Ltd 1994. All rights reserved.



ORKS

SPLATTA KANNON

THE COMPLETE SPLATTA KANNON
CONSISTS OF:
1 x SPLATTA KANNON
1 x GUN SHIELD
1 x CHASSIS
2 x WHEEL
1 x GRETCHIN WITH SPANNER
1 x GRETCHIN WITH SHELLS

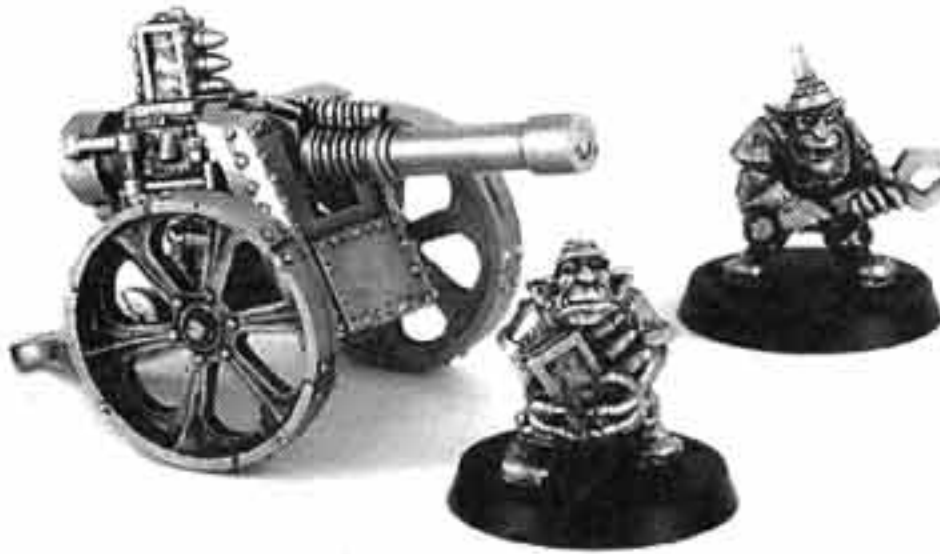

EXAMPLE OF COMPLETED SPLATTA KANNON AND CREW

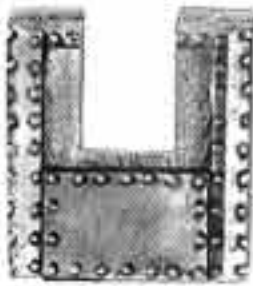

GUN SHIELD
70805/5

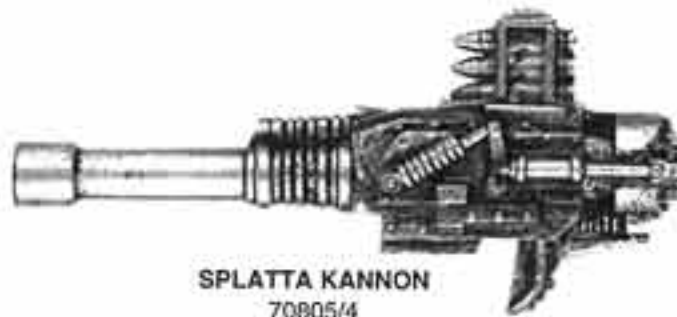

SPLATTA KANNON
70805/4

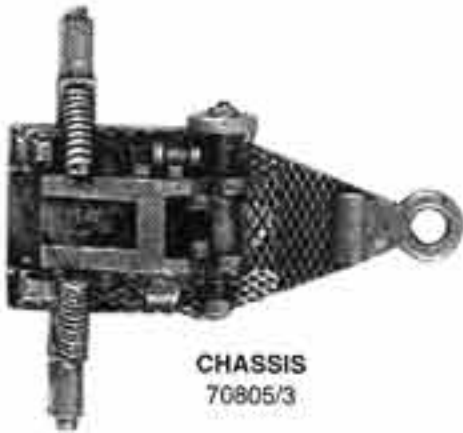

CHASSIS
70805/3



WHEEL
70805/6



GRETCHIN WITH SPANNER
70805/2



GRETCHIN WITH SHELLS
70805/1

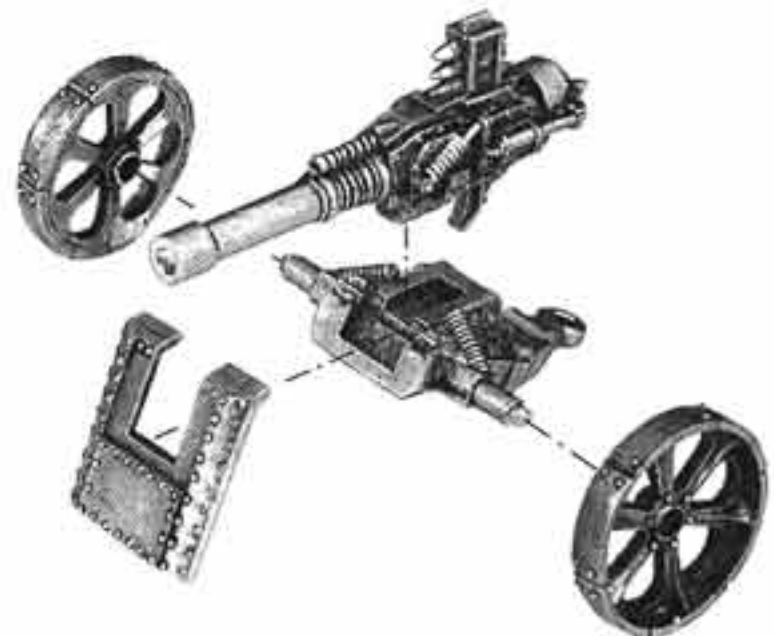

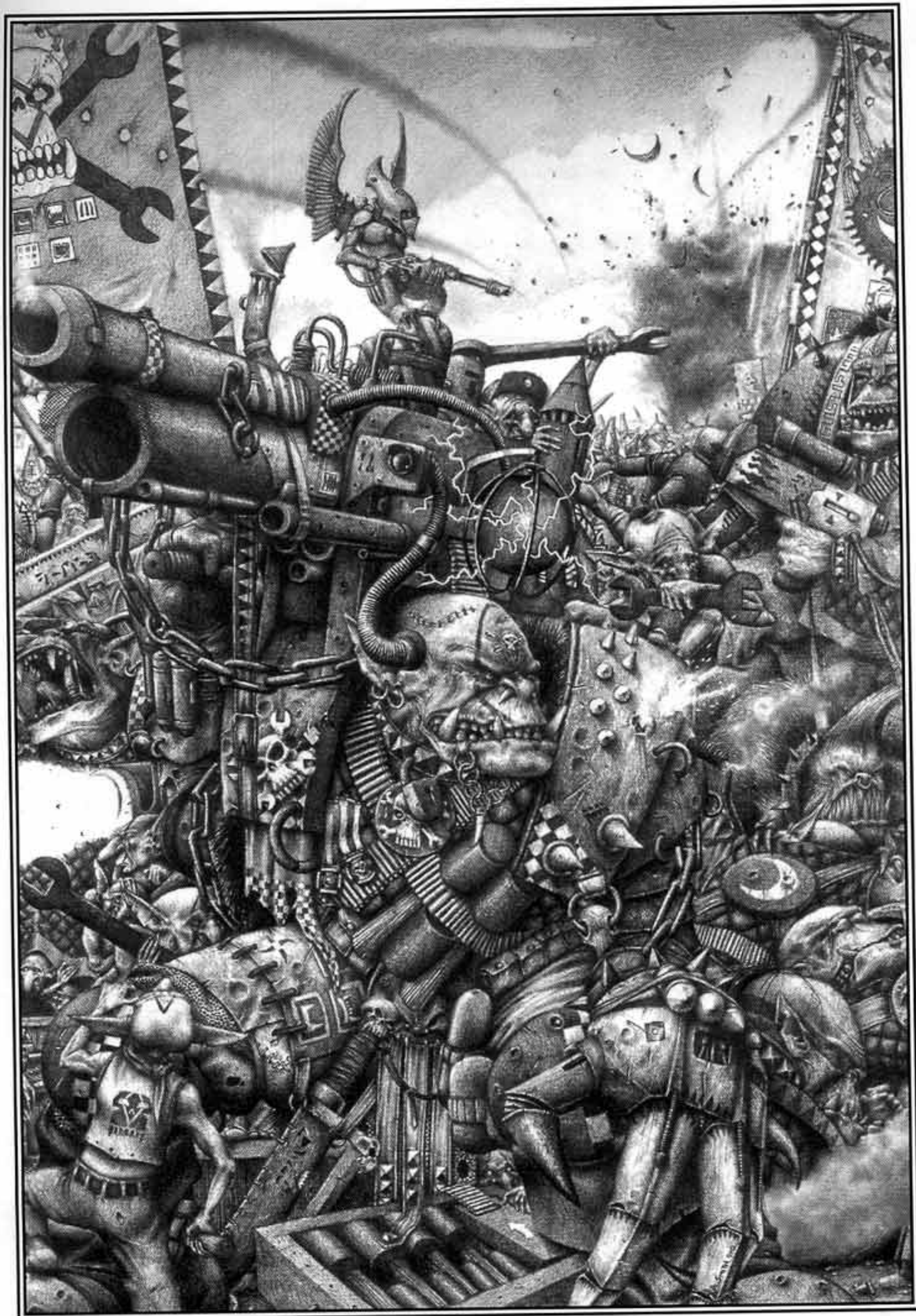

ORKS

ORK DREADNOUGHT



EXAMPLE OF COMPLETED ORK DREADNOUGHT

THE COMPLETED ORK DREADNOUGHT

- CONSISTS OF:
- 1 x BANNER TOP
 - 1 x BANNER
 - 1 x BODY FRONT
 - 1 x BODY BACK
 - 1 x HATCH
 - 1 x DREADNOUGHT ORK
 - 1 x EXHAUST
 - 1 x CLAW 1
 - 1 x CLAW 2
 - 1 x LAS CANNON
 - 1 x HEAVY BOLTER
 - 1 x LEGS
 - 2 x FOOT



BANNER TOP
0431/6



BANNER
0431/5



EXHAUST
0431/7



DREADNOUGHT
ORK
0431/2



HATCH
0431/1



CLAW 1
0431/8



CLAW 2
0431/9



BODY FRONT
0431/3



BODY BACK
0431/4

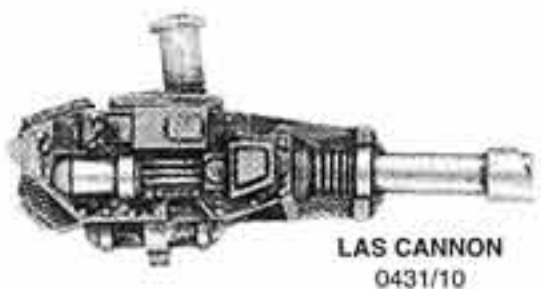

LAS CANNON
0431/10



FOOT
13

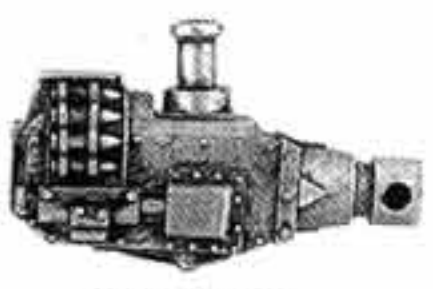
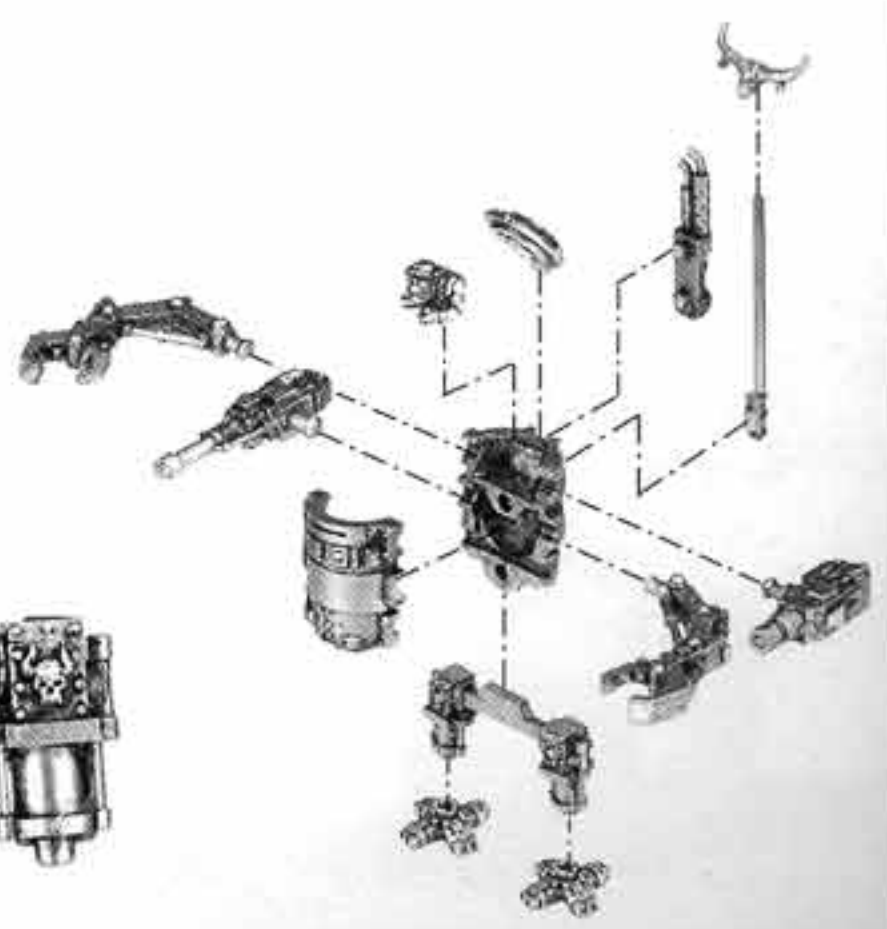

HEAVY BOLTER
0431/11



LEGS
0431/12

© Copyright Games Workshop Ltd 1994. All rights reserved.



GADEL
MINIATURES

Snakebite Ork Nobz

Snakebite Nobz

These models are supplied with a plastic Ork Arms Sprue and an Ork Weapons Sprue as standard

A complete Ork Nob consists of:

- 1 x Snakebite Nob Body
- 1 x Snakebite Banner
- 1 x Plastic Ork Arms Sprue
- 1 x Plastic Ork Weapons Sprue



Snakebite Nob 1
70803/5



Snakebite Nob 2
70803/6



Snakebite Runtherd
70803/7



Banner 1
0434/4



Banner 2
0434/2



Banner 3
0434/3



Banner 4
0434/1

Snakebite Boarboy Nobz

These models are supplied with a plastic Ork Arms Sprue, a plastic Ork Weapons Sprue and a plastic Boar Sprue as standard

A completed Ork Boarboy Nob consists of:

- 1 x Boarboy Nob Body
- 1 x Boarboy Nob Legs
- 1 x Snakebite Banner
- 1 x Cyboar Head
- 1 x Plastic Ork Arms Sprue
- 1 x Plastic Ork Weapons Sprue
- 1 x Plastic Boar Sprue



Snakebite Boarboy Nob Body 1
70804/5



Snakebite Boarboy Nob Body 2
70804/6



Snakebite Boarboy Nob Legs 1
70804/7



Snakebite Boarboy Nob Legs 2
70804/8



Cyboar Head 1
70804/9



Cyboar Head 2
70804/10

Examples of completed Snakebite Nobz and Snakebite Boarboy Nob



Miniatures supplied unpainted. **WARNING:** This product contains lead which may be harmful if chewed or swallowed. Citadel Miniatures are not recommended for children under 14 years of age.
 © Copyright Games Workshop Ltd 1994. All rights reserved.



Designed by Alan Perry

Snakebite Orks

Snakebites

These models are supplied with a plastic Ork Arms Sprue and an Ork Weapons Sprue as standard

A complete Snakebite Ork consists of:
 1 x Snakebite Ork Body
 1 x Snakebite Banner
 1 x Plastic Ork Arms Sprue
 1 x Plastic Ork Weapons Sprue



Snakebite 1
70802/7



Snakebite 2
70802/5



Snakebite 3
70802/6



Banner 1
0434/4



Banner 2
0434/2



Banner 3
0434/3



Banner 4
0434/1

Snakebite Boarboyz

A complete Snakebite Boarboy consists of:
 1 x Snakebite Boarboy Body
 1 x Snakebite Boarboy Legs
 1 x Snakebite Banner
 1 x Plastic Ork Arms Sprue
 1 x Plastic Ork Weapons Sprue
 1 x Plastic Boar Sprue

These models are supplied with a plastic Ork Arms Sprue, an Ork Weapons Sprue and a plastic Boar Sprue as standard



Boarboy Torso 1
0434/5



Boarboy Torso 2
0434/6



Boarboy Torso 3
0434/7



Boarboy Legs 1
0434/8



Boarboy Legs 2
0434/9



Boarboy Legs 3
0434/10

Examples of Completed Snakebite Orks



© Copyright Games Workshop Ltd 1994. All rights reserved.



CHAOS MARINES

NURGLE PLAGUE MARINES



PLAGUE MARINE
WITH BOLTER 1
70460/2



PLAGUE MARINE
WITH BOLTER 2
70460/3



PLAGUE MARINE WITH
CHAINSWORD AND BOLTER
70460/1

WORLD EATERS OF KHORNE ASSAULT MARINES



WORLD EATERS
ASSAULT MARINE 1
70465/1



WORLD EATERS
ASSAULT MARINE 2
70465/2



WORLD EATERS
ASSAULT MARINE 3
70465/3

WORLD EATERS OF KHORNE



WORLD EATER 1
70466/1



WORLD EATER 2
70466/2



WORLD EATER 3
70466/3

THESE MINIATURES ARE SUPPLIED WITH A CHAOS MARINE BACKPACK SPRUE AS STANDARD

Miniatures supplied unpainted. **WARNING.** This product contains lead which may be harmful if chewed or swallowed. Citadel Miniatures are not recommended for children under 14 years of age.
© Copyright Games Workshop Ltd 1994. All rights reserved.



Designed by Dave Andrews



CARNIFEX

CARNIFEX



EXAMPLE OF THE COMPLETED CARNIFEX

THE COMPLETED CARNIFEX CONSISTS OF:

- 1 x HEAD
- 1 x UPPER BODY
- 1 x LOWER BODY
- 1 x UPPER RIGHT CLAW
- 1 x LOWER RIGHT CLAW
- 1 x UPPER LEFT CLAW
- 1 x LOWER LEFT CLAW
- 1 x RIGHT LEG
- 1 x LEFT LEG



HEAD
72642/1



UPPER BODY
72642/2

LOWER RIGHT CLAW
72642/8



UPPER RIGHT CLAW
72642/9



UPPER LEFT CLAW
72642/6



LOWER LEFT CLAW
72642/7



RIGHT LEG
72642/5



LEFT LEG
72642/4



LOWER BODY
72642/3

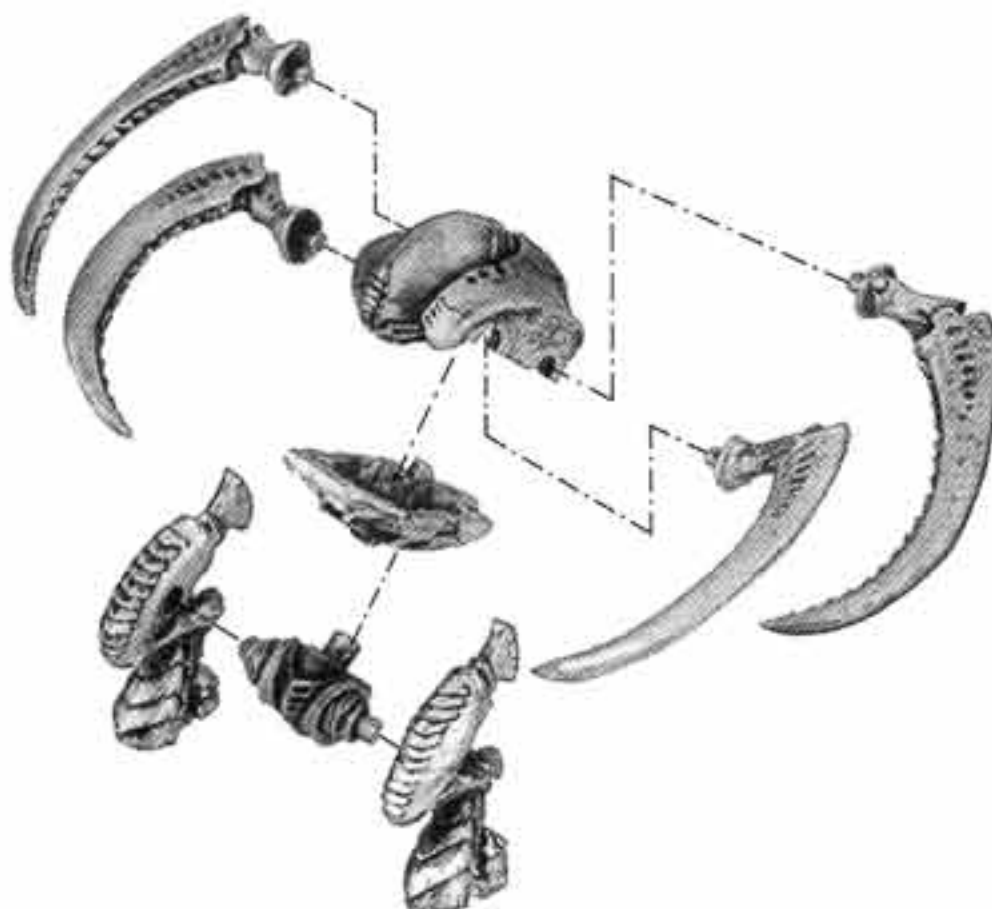

Miniatures supplied unpainted. **WARNING.** This product contains lead which may be harmful if chewed or swallowed. Citadel Miniatures are not recommended for children under 14 years of age.
© Copyright Games Workshop Ltd 1994. All rights reserved.



CITADEL
MINIATURES

WARHAMMER

40,000

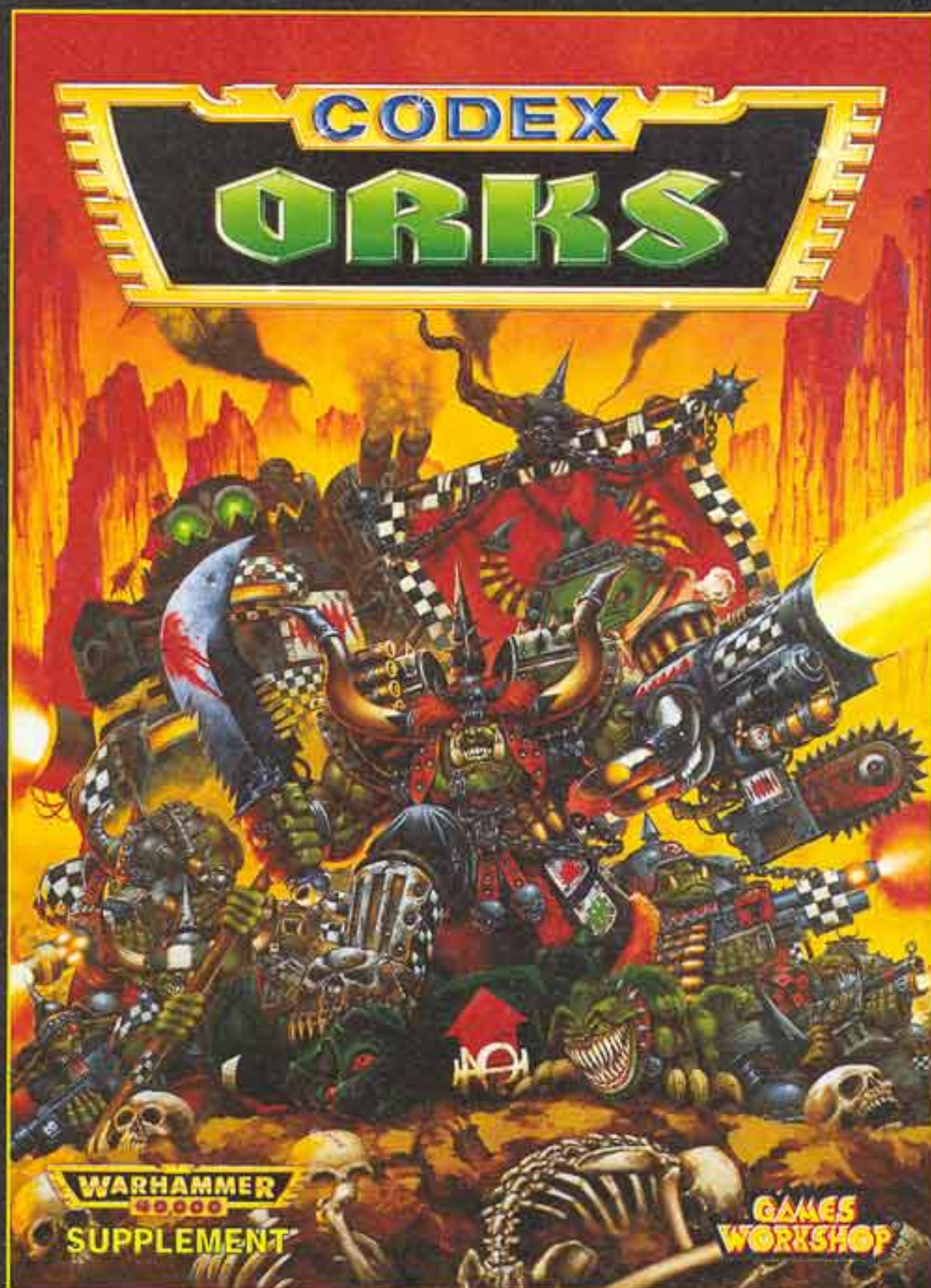

SPACE ORKS

The Orks are the most savage and warlike race in the whole galaxy. They live for war and are constantly striving to defeat their neighbours whether they are human, Eldar or even other Orks! This essential companion to the Warhammer 40,000 game describes the Orks and their armies in complete and exhaustive detail.

WAAAGH DA ORKS!

A comprehensive background section describes the origins of the Ork race, and all aspects of Ork 'kultur'. The different clans and types of Ork are described along with the Orks' amazing technology.

SPECIAL RULES

Game rules are provided for all the Ork warriors and war machines, including a host of new troop types, weapons and equipment such as Blood Axe Kommandos, Kustom Kombi-Weapons and Ork Mega-armour. New Wargear cards are provided for Mekaniak Tools, Sniffer Squigs, Ghazghkull's Adamantium Skull and many others.

ARMY LIST

A complete army list for the Ork army includes Warlords, Nobz, Warpheadz, Dreadnoughts, and many more Ork warriors, vehicles and war machines. A selection of Ork special characters is provided, such as the Goff Warlord Ghazghkull Mag Uruk Thraka, the crazed Deathskull Painboy known as Mad Doc Grotznik and Kaptin "Flash Git" Badrukk and his famous Freebooter pirate gang.

'EAVY METAL PAGES

Photographs and detailed descriptions of how to paint an Ork army in all its colourful and ferocious glory by the Games Workshop 'Eavy Metal team.

CODEX ORKS IS NOT A COMPLETE GAME. YOU NEED A COPY OF WARHAMMER 40,000 TO USE THE CONTENTS OF THIS BOOK.

Games Workshop and Warhammer are registered trademarks of Games Workshop Ltd.
Citadel, Games Workshop and Ork are trademarks of Games Workshop Ltd.
© Games Workshop Ltd, 1994. All rights reserved.



**GAMES
WORKSHOP**

WARHAMMER

WHITE
DWARF
PRESENTS



WARHAMMER CHAOS DWARFS

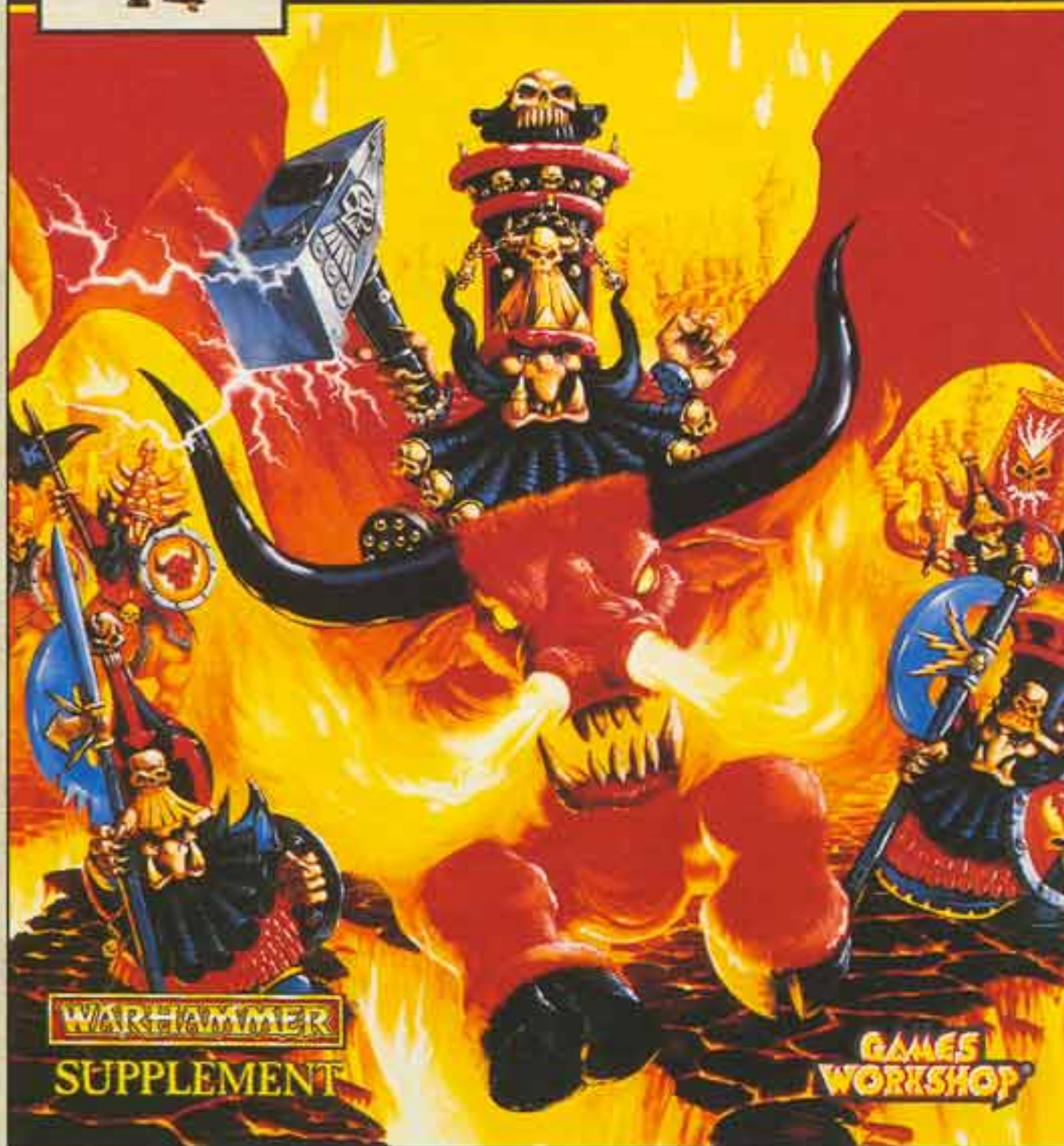

CHAOS DWARFS

The Chaos Dwarfs are a vile, black-hearted race, forever waging war in their relentless search for victims to enslave.



Shrouded by the smoke of a thousand forges, the foul empire of the Chaos Dwarfs lies deep inside the Dark Lands.

Far below the bitter earth, the tortured slaves labour in heavy chains, endlessly seeking out precious metals and minerals for their evil masters' plans and desires.

ARMY LIST

This full-colour book is a compilation of all the Chaos Dwarf articles first printed in White

Dwarf magazine plus additional unpublished material. These include rules for new Chaos Dwarf characters, the full range of Chaos Dwarf troops and war machines, a complete Chaos Dwarf army list and an exciting Warhammer battle report.

WARHAMMER CHAOS DWARFS IS NOT A COMPLETE GAME. YOU WILL NEED A COPY OF WARHAMMER TO USE THE CONTENTS OF THIS BOOK.

The Games Workshop logo and the Warhammer logo are registered trademarks of Games Workshop Ltd.

Citadel, Games Workshop and 'Eavy Metal are trademarks of Games Workshop Ltd.
© Games Workshop Ltd, 1994. All rights reserved.



**GAMES
WORKSHOP**

WARHAMMER ARMIES

CHAOS



The sun dims in the sky. Blood rains from the darkening clouds. The Realm of Chaos spews a tide of monstrous creatures upon the lands of men. Hideous beasts swarm south, leaving terror and destruction in their wake. Mortals despair, for your doom is come upon you!

The Warhammer Armies – Chaos supplement contains new rules, spells, magic items and a complete army list for fighting battles with Chaos armies in Warhammer. The box contains an 88 page book which details the history and background of the four Chaos Powers – Khorne, Nurgle, Slaanesh and Tzeentch – and provides a full list of their earthly minions, from mighty Chaos Champions to depraved Chaos Spawn. The set also contains dozens of full-colour cards describing Chaos Gifts, new Magic Items, Magic Spells and Chaos Rewards.

**WARHAMMER ARMIES – CHAOS IS NOT A COMPLETE GAME.
YOU NEED A COPY OF WARHAMMER TO USE
THE CONTENTS OF THIS SUPPLEMENT.**

The Games Workshop logo and the Warhammer logo are registered trademarks of Games Workshop Ltd.
Citadel, Games Workshop, Khorne, Nurgle, Tzeentch and Slaanesh are trademarks of Games Workshop Ltd.
© Games Workshop Ltd, 1994. All rights reserved.

GAMES WORKSHOP



CITADEL
MINIATURES

CITADEL COLOUR

BRUSHES AND PAINTS



THE NEW CITADEL COLOUR RANGE

The new Citadel Colour Paint Set contains the core colours in the new range: the three primaries – Blood Red, Sunburst Yellow and Enchanted Blue, plus Chaos Black, Skull White, Mithril Silver, Goblin Green, Snakebite Leather and Bronzed Flesh with Flesh Wash as the

shading colour for standard skin tones. The set also contains two free Citadel miniatures – a Chaos Warrior and a Space Marine, as well as a high quality paintbrush.

Each of the other sets in the range contains six colours that have been specially chosen for the individual races or Space Marine Chapters.

The Citadel Brush Set contains a Standard brush for general painting, a Fine Detail brush and a Small Drybrush.

The Citadel and Games Workshop logo are registered trademarks of Games Workshop Ltd.
Blood Angels, Orks and Gretchin are trademarks of Games Workshop Ltd.
© Games Workshop Ltd, 1994. All rights reserved.



'EAVY METAL

CITADEL MINIATURES

MODELLING GUIDE

MODELLING GUIDE

The Citadel Miniatures Modelling Guide contains everything you need to know about modelling as well as stunning examples from some of the world's foremost painters and modellers.

Inside you'll find detailed explanations of all the different techniques, from basic cleaning and assembly through simple weapon swaps to more complex multi-part conversions and dioramas.

This simple step-by-step guide by master painter Mike McVey is lavishly illustrated with full colour photos. Throughout the guide, Mike uses his own modelling projects to provide detailed examples of each step.

If you haven't tried modelling before, the guide is packed with hints and advice on basic conversions to help you get started.

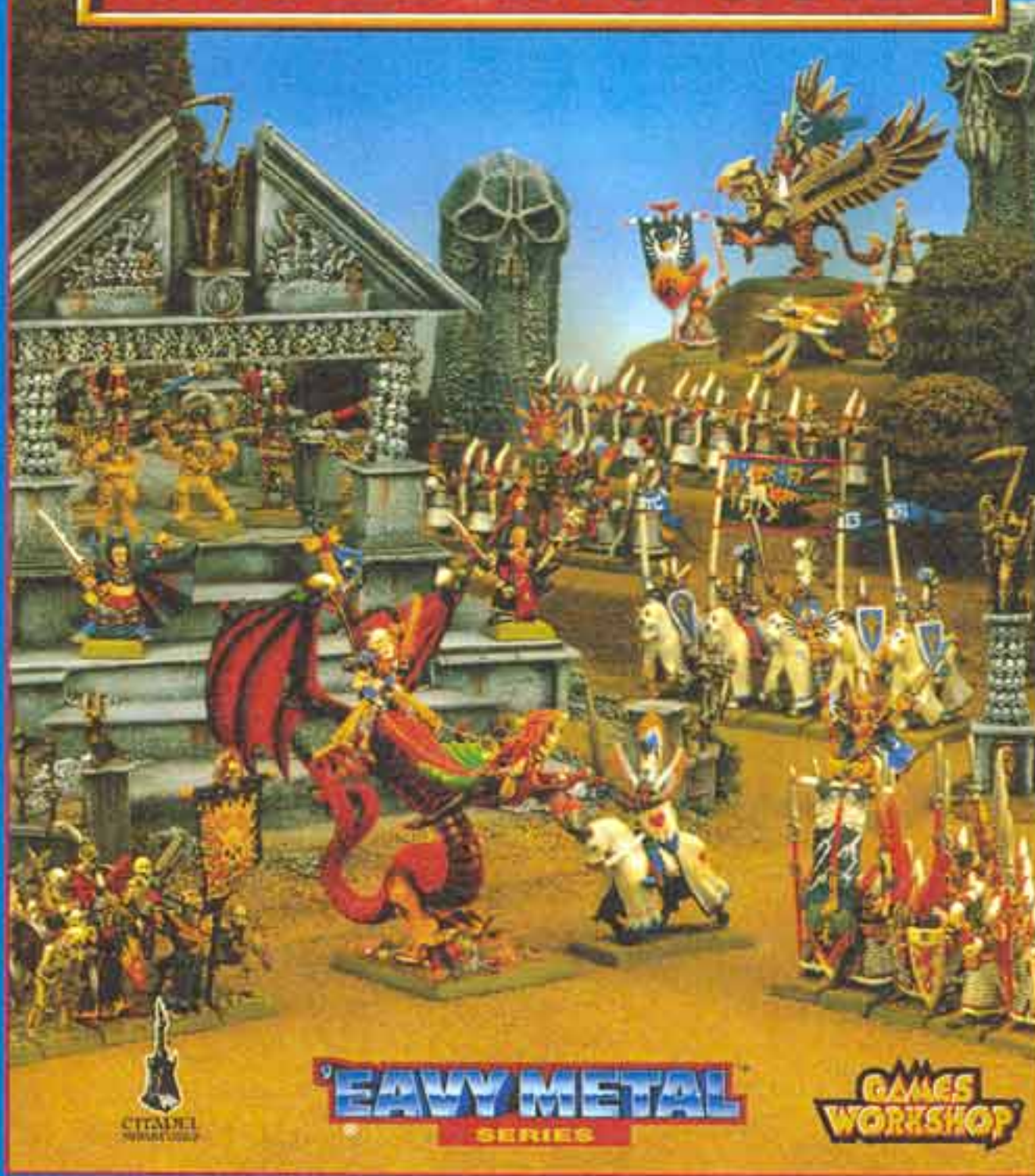

When you've got some experience you'll be able to tackle some of the more challenging projects featured, even building your own unique army!

From basic troops through to heroes and character models, there are no limits to what you can do. Whether you're just starting out or you're already an experienced modeller, the Citadel Miniatures Modelling Guide provides you with all the information you need.

The 'Eavy Metal Painting Guide and 'Eavy Metal Warhammer 40,000 Painting Guide are also written by Mike McVey, and are available from your local Games Workshop store or through Mail Order.



The Games Workshop logo and the 'Eavy Metal logo are registered trademarks of Games Workshop Ltd. Citadel and Games Workshop are trademarks of Games Workshop Ltd. © Games Workshop Ltd. 1994. All rights reserved.

GAMES WORKSHOP

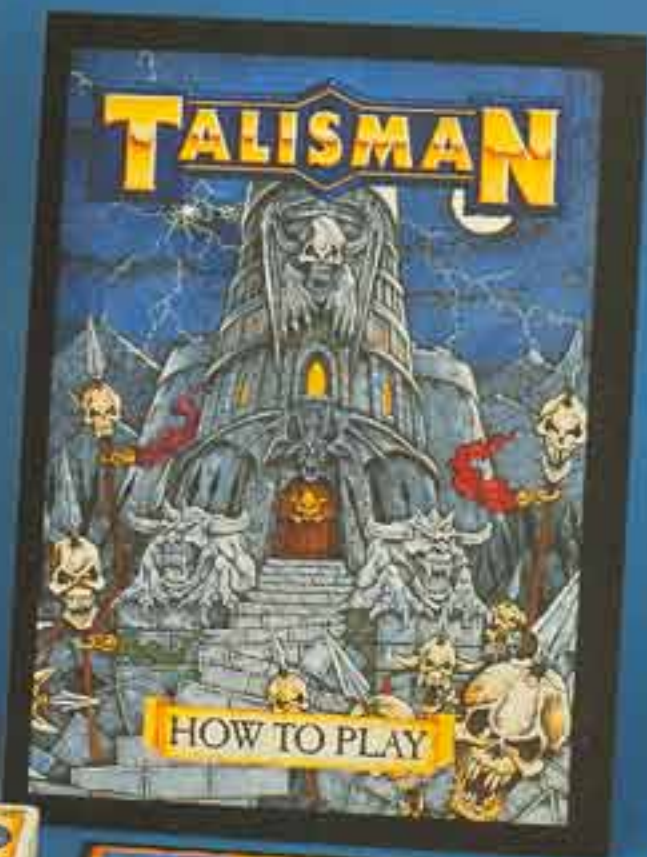
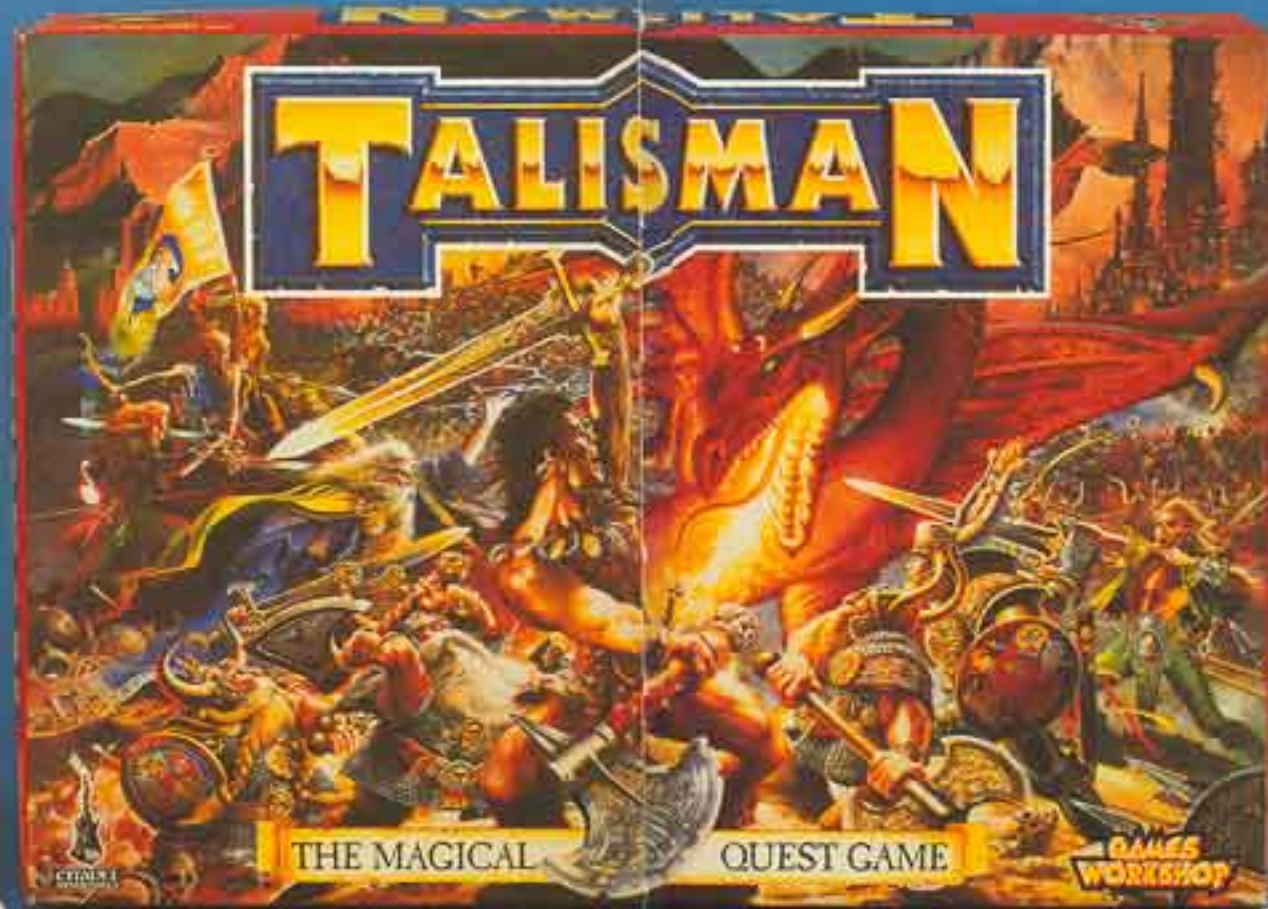
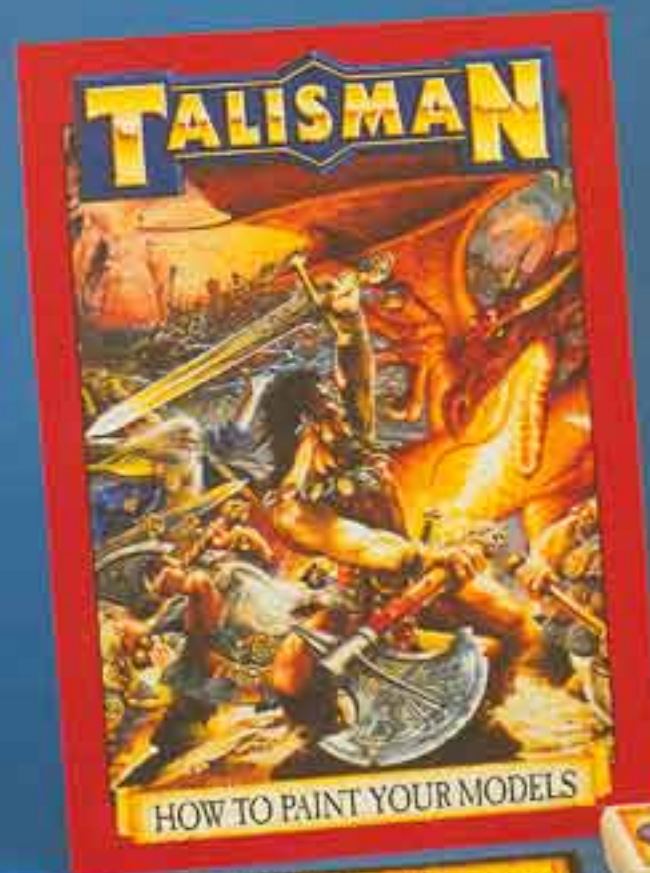

TALISMAN[®]

DUNGEON OF DOOM



Contents and components may vary from those illustrated. Models are supplied unpainted.

NEW REALMS OF ADVENTURE

Talisman – Dungeon of Doom contains two brand new board sections to expand your Talisman games. Enter the dark and terror haunted dungeon of the Lord of Darkness and journey to the perilous mountain realm of the Eagle King. With two brand new sets of adventure cards, you can pit yourself against powerful new foes and discover vast treasures including the Talisman itself!

Talisman – Dungeon of Doom also contains six new characters, so now you can venture out as a mighty Chaos Warrior, a High Priest, a Beastman, a Shaman, a Druid or a Fire Wizard, each represented by a superbly detailed plastic Citadel Miniature.

THE DUNGEON OF DOOM BOX CONTAINS

- 1 Dungeon board section • 1 Mountain board section • 6 Citadel Miniatures
- 6 Character cards • 1 Rules sheet • 40 Dungeon cards • 37 Mountain Cards
- 3 Adventure cards • 4 Special Item Cards • 1 Realm Dice



The Citadel castle, the Games Workshop logo, and Talisman are registered trademarks of Games Workshop Ltd. Citadel and Games Workshop are trademarks of Games Workshop Ltd. © Games Workshop Ltd, 1994. All rights reserved.



TALISMAN[®]

CITY OF ADVENTURE

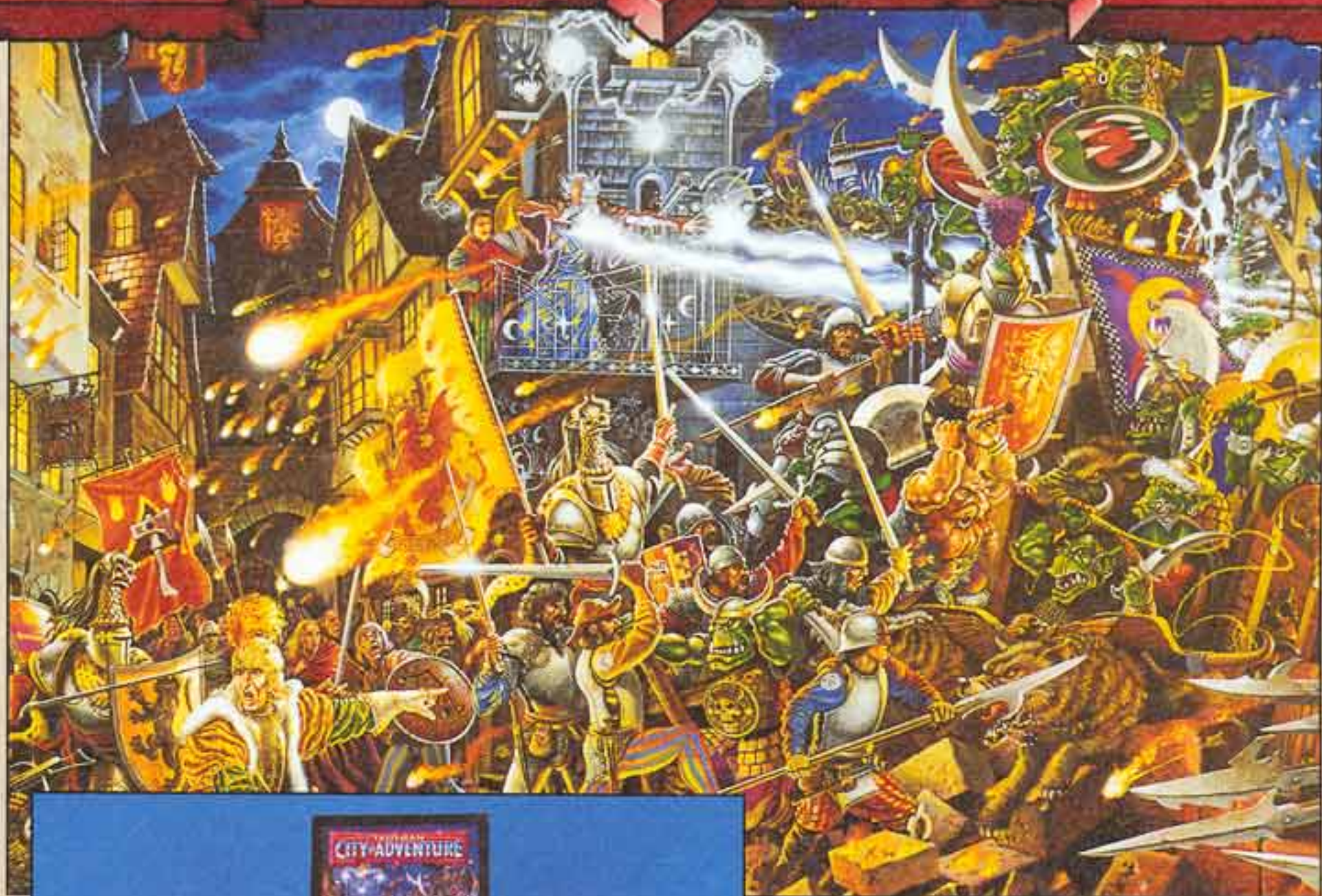

Contents and components may vary from those illustrated. Models are supplied unpainted.

NEW REALMS OF ADVENTURE

Talisman – City of Adventure contains two brand new board sections to expand your Talisman games. Enter the city realm of the Emperor and the forest realm of the Wraith Lord. With two brand new sets of adventure cards, you can pit yourself against fearsome new foes and uncover vast treasures including the prized Talisman itself!

Talisman – City of Adventure also contains six new characters, so now you can venture out as a Dragon Slayer, an Assassin, a Witch Elf, a Black Orc, a Chaos Dwarf or a Halfling, each represented by a superbly detailed plastic Citadel Miniature.

THE DUNGEON OF DOOM BOX CONTAINS

- 1 City board section • 1 Forest board section • 6 Citadel Miniatures
- 6 Character cards • 1 Rules sheet • 37 City cards • 40 Forest Cards
- 7 Purchase cards • 4 Adventure cards • 10 Special Cards • 1 Realm Dice



The Citadel castle, the Games Workshop logo, and Talisman are registered trademarks of Games Workshop Ltd.
Citadel and Games Workshop are trademarks of Games Workshop Ltd.
© Games Workshop Ltd, 1994. All rights reserved.

GAMES[®]
WORKSHOP



BLOOD BOWL

BLOOD BOWL

BLOOD BOWL



THE GAME OF FANTASY FOOTBALL

RESERVES

KNOCKED OUT

FIRST HALF

SECOND HALF

RE-ROLLS

1	2	3	4	5	6	7	8
1	2	3	4	5	6	7	8

HUMAN TEAM

Team Re-rolls: 4
Team Fan Factor: 4

THROWER	BLITZER	BLOCKER	DOGGING
6	7	3	3
3	3	3	8
3	8	8	BLOCK

DOGGING: Can be used on any opponent who is not a blocker or a blitzer. It is used to knock an opponent out of the game. The player who is knocked out is placed in the 'Knocked Out' area.

PICKING UP THE BALL: The player who picks up the ball is the one who will throw it. The player who is picked up is placed in the 'Knocked Out' area.

CATCHING THE BALL: The player who catches the ball is the one who will throw it. The player who is caught is placed in the 'Knocked Out' area.

ORC TEAM

Team Re-rolls: 3
Team Fan Factor: 6

THROWER	BLITZER	BLOCKER	DOGGING
5	6	3	3
3	3	3	9
3	8	9	BLOCK

DOGGING: Can be used on any opponent who is not a blocker or a blitzer. It is used to knock an opponent out of the game. The player who is knocked out is placed in the 'Knocked Out' area.

PICKING UP THE BALL: The player who picks up the ball is the one who will throw it. The player who is picked up is placed in the 'Knocked Out' area.

CATCHING THE BALL: The player who catches the ball is the one who will throw it. The player who is caught is placed in the 'Knocked Out' area.

SCRAPPER

CHIEF OGRE

WARRIOR

WARRIOR

WARRIOR



WARHAMMER

NEW BOXED SETS

These two new boxed sets each contain ten highly detailed plastic Citadel Miniatures.



★ CHAOS WARRIORS ★



CHAOS DWARFS

These models require assembly. We recommend that the models are carefully removed from the plastic sprue with a sharp modelling knife and that they are undercoated before painting with Citadel Paints. These Citadel miniatures are moulded in a hard styrene compound which is particularly suited for painting and modelling.



Citadel Miniatures are not recommended for Children under 14 years of age.
Games Workshop, the Games Workshop logo, Citadel, Warhammer
and the Citadel castle are registered trademarks of Games Workshop Ltd.
© Games Workshop Ltd, 1994. All rights reserved.

**GAMES
WORKSHOP**

WARHAMMER

NEW CHAOS BOXED

INCLUDES
FULL-COLOUR
BANNERS



Models supplied unpainted. Includes a sheet of full-colour banners.

CHAOS KNIGHTS



Models supplied unpainted.

CHAOS BEASTMEN



WARNING! The Chaos Knights boxed set includes parts which contain lead and may be harmful if chewed or swallowed.
Citadel Miniatures are not recommended for children under 14 years of age.

Games Workshop the Games Workshop logo, Citadel, Warhammer and the Citadel castle are registered trademarks of Games Workshop Ltd.
© Games Workshop Ltd, 1994. All rights reserved.

**GAMES
WORKSHOP**

Miniatures designed by Michael Perry.

Miniatures designed by Michael Perry.

WARHAMMER

NEW UNDEAD BOXED SETS

SKELETON WARRIORS



UNDEAD CHARIOT

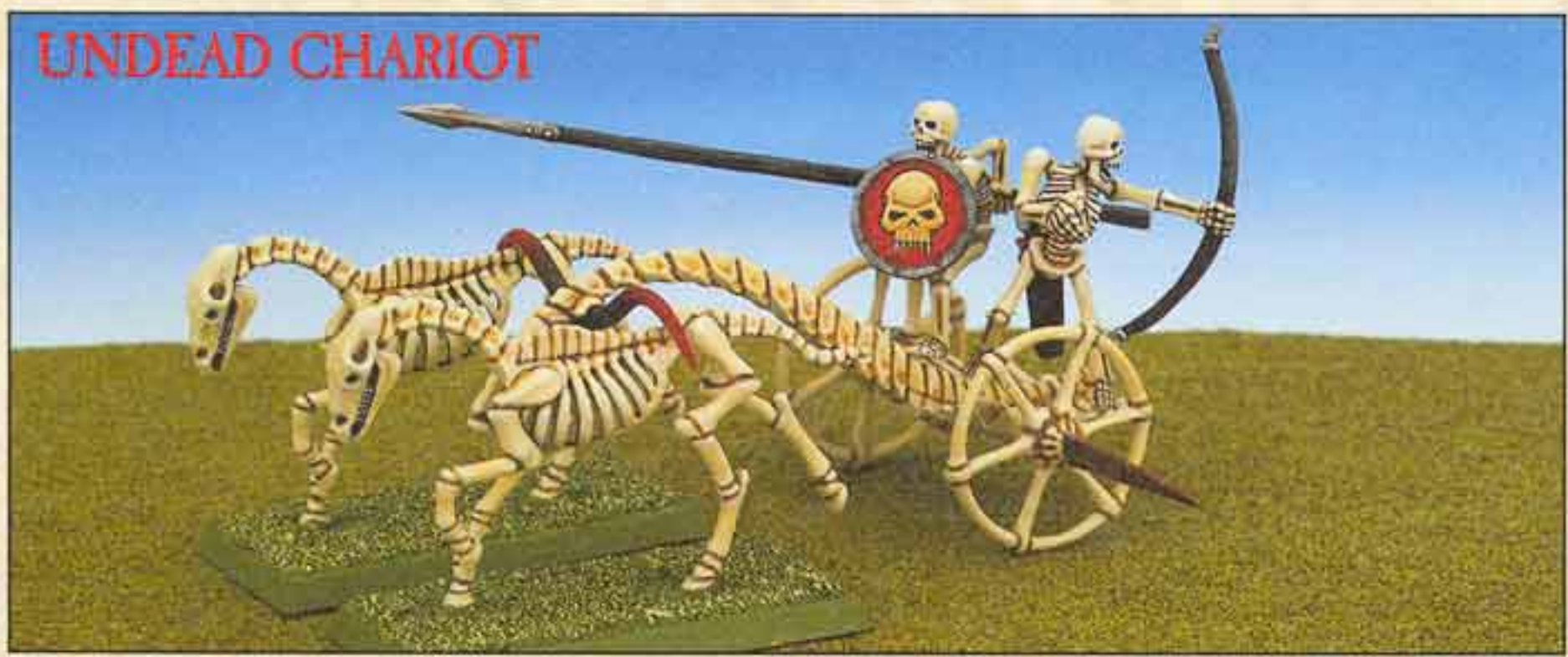

SKELETON HORSEMEN



Games Workshop, the Games Workshop logo, Citadel, Warhammer and the Citadel castle are registered trademarks of Games Workshop Ltd.
© Games Workshop Ltd, 1994. All rights reserved.





WARHAMMER

40,000

PLASTIC BOXED SETS

IMPERIAL SPACE MARINES™



BOXED SET
INCLUDES
3 FULL COLOUR
BANNERS AND
3 TRANSFER
SHEETS

SPACE ORK™ WARRIORS



BOXED SET
INCLUDES
FULL COLOUR
TRANSFER
SHEET

GRETCHIN™



All models supplied unpainted.



The Citadel castle, the Games Workshop logo, the Warhammer 40,000 logo and Space Marine are registered trademarks of Games Workshop Ltd.
Citadel, Games Workshop, Ork and Gretchin are trademarks of Games Workshop Ltd.
© Games Workshop Ltd, 1994. All rights reserved.

GAMES
WORKSHOP

WARHAMMER

40,000

SPACE MARINES

WARRIORS OF THE IMPERIUM



Models supplied unpainted.

THIS BOXED SET CONTAINS SIX COMPLETE SPACE MARINE MODELS CONSISTING OF:

- 2 Space Marine torso and leg sprues (Three models per sprue).
- 2 Space Marine bolter and back pack sprues (Enough wargear for all six models).
- 2 Space Marine arms sprues (Sufficient for all six models).

Space Marines are the finest warriors in the Imperium of Man.

This boxed set contains all the components you need to assemble six plastic Space Marine miniatures.

Each multi-part model can be quickly assembled into an almost infinite variety of poses. The miniatures can then be painted in the Chapter colours of your choice to increase the fighting power of your Space Marine forces.

These are multi-part plastic models which requires a degree of modelling skill to assemble.

The Citadel castle, the Games Workshop logo, Warhammer 40,000 and Space Marine are registered trademarks of Games Workshop Ltd. Citadel and Games Workshop are trademarks of Games Workshop Ltd. © Games Workshop Ltd, 1994. All rights reserved.



GAMES WORKSHOP

WARHAMMER

40,000

ELDAR® GUARDIANS



Miniatures designed by J. Goodwin

Eldar are the most ancient and mysterious beings in the universe. The Eldar race is in a state of constant readiness for war and every Eldar is trained in the Eldar path and the sacred arts of combat. The majority of Eldar fight as Guardians, heroic warriors clad in mesh armour and armed with lasguns. Eldar Guardians are at the forefront of the Eldar host as it strikes the enemy swiftly, devastating all who stand before them.

The Eldar Guardians boxed set contains 10 plastic Eldar Guardians with plug-in lasguns. The models can be painted in the Craftworld colours of your choice and the box includes a sheet of colour transfers.

These models require assembly. We recommend that the parts are cleaned and trimmed with a modelling knife before being painted with Citadel paints.

Citadel, the Citadel castle, Eldar, Games Workshop and Warhammer are registered trademarks of Games Workshop Ltd. © Games Workshop Ltd, 1994. All rights reserved.



**THIS BOXED SET
CONTAINS AN
ELDAR® GUARDIANS
TRANSFER SHEET**



WARHAMMER

40,000

WORLD EATERS CHAOS SPACE MARINES



Khorne is the great warrior of Chaos, the ferocious Blood God. The World Eaters of Khorne Chaos Space Marines are his ultimate warriors, steeped in martial honour and the ethic of war, chosen for the final conflict when Khorne awakes and the universe is drenched in the blood of his enemies.

This boxed set contains 10 plastic World Eaters of Khorne Chaos Space Marines and a sheet of Citadel waterslide transfers.



These models require assembly. We recommend that the parts are cleaned and trimmed with a modelling knife before being painted with Citadel paints.

Citadel, the Citadel castle, Games Workshop, Space Marines and Warhammer are registered trademarks of Games Workshop Ltd. World Eaters is a trademark of Games Workshop Ltd. © Games Workshop Ltd, 1995. All rights reserved.



**EACH BOXED SET
CONTAINS A
WORLD EATERS™
CHAOS SPACE MARINES™
TRANSFER SHEET**

WARHAMMER

40,000

PLASTIC BOXED SETS

TYRANID WARRIORS



GENESTEALERS™



All models supplied unpainted.



The Citadel castle, the Games Workshop logo and the Warhammer 40,000 logo are registered trademarks of Games Workshop Ltd.
Citadel, Games Workshop, Tyranid and Genestealer are trademarks of Games Workshop Ltd.
© Games Workshop Ltd, 1994. All rights reserved.

GAMES WORKSHOP

EPIC

NEW EPIC BOXED SETS

These two new boxed sets of plastic models are ideal for expanding your Epic armies.

7 KNIGHT PALADINS



When the Titan Legions march to war they are accompanied by large contingents of Imperial Knights. Sleek and deadly, these mighty war machines hunt down the enemy, blasting them with their battlecannons or ripping through their armour with deadly, powerful chainfists.

12 ORK[®] BONEBREAKAS

The Bonebreaka is a deadly tank used by all the Ork clans. Armed with a fearsome battlecannon and equipped with a monstrous spiked roller on the hull, the Bonebreaka smashes through the enemy lines, snapping and crushing the very bones of its enemies!



EPIC
TITAN LEGIONS

EPIC
SPACE MARINE

These models require assembly. We recommend that the parts are cleaned and trimmed with a modelling knife before being painted with Citadel paints.

Citadel, the Citadel casts, Epic, Games Workshop, Ork and Space Marine are registered trademarks of Games Workshop Ltd.

Titan Legions is a trademark of Games Workshop Ltd.

© Games Workshop Ltd, 1995. All rights reserved.



GAMES
WORKSHOP

CITADEL MINIATURE CATALOGUES

The Citadel Catalogues provide a comprehensive listing of the current range of Citadel metal and plastic miniatures and all the Games Workshop games and books in print. Fully illustrated with thousands of photographs, the Citadel catalogues are the best way for you to select and order anything from a specific model to an individual game component.



WHITE DWARF MAGAZINE

New catalogue pages are regularly published in White Dwarf magazine. This monthly publication contains full news and details of all the latest releases from Games Workshop, plus articles on painting and modelling as well as regular features on all of your favourite games.



HOW TO BUY YOUR CITADEL MINIATURES

The very best way to buy Citadel miniatures is to visit a Games Workshop store where you'll be able to examine the models at first hand. All our Games Workshop staff are keen enthusiasts who will be able to give you help regarding any of the figures you would like. The vast majority of models shown in the catalogues are readily available from a Games Workshop store and other good hobby stores. However, the range is so huge that only our Mail Order department can supply everything.

Games Workshop Mail Order is a great way to purchase all the latest releases from Games Workshop and Citadel Miniatures. Our Mail Order staff will be more than happy to advise you on any special character miniatures or other models that you might need for your army. We have included full details on the Games Workshop Mail Order service in the enclosed price list. If you have any questions about the availability of miniatures featured in this or any other Citadel catalogue give our Mail Order service a ring and our expert staff will do their best to help.



**OUR MAIL ORDER LINES ARE OPEN
24 HOURS A DAY MONDAY TO FRIDAY
8AM TO 10PM SATURDAYS AND SUNDAYS**

MAIL ORDER HOTLINE (01773) 713213

If you are posting your order, please send it to:

Games Workshop Mail Order Service, Chewton Street,
Hilltop, Eastwood, Nottingham NG16 3HY.

Or you can fax your order through on: (01773) 533453





THE EMPEROR TITAN CASSUS BELLI LEADS AN IMPERIAL ASSAULT THROUGH AN ORK SETTLEMENT



CATACHAN JUNGLE FIGHTERS DEFEND AN IMPERIAL BUNKER AGAINST ORK BLOODAXE KOMMANDOS



A MATCH BETWEEN THE CHAOS ALL STARS AND THE ATHELORN AVENGERS WOOD ELF TEAM



This book is a compilation of catalogue pages featured in White Dwarf magazine during 1994.

ISBN: 1 872372 89 9



5 011921 007257 >

Games Workshop Inc.,
3431-C Benson Avenue,
Baltimore, Maryland,
21227-1072
USA.

Games Workshop Ltd.,
Chewton Street,
Hilltop, Eastwood,
Nottingham, NG16 3HY, England.

GAMES WORKSHOP®

Games Workshop and the Games Workshop logo, Citadel, Citadel Castle, Warhammer and White Dwarf are registered trademarks of Games Workshop Ltd. The exclusive copyright in the contents of this package is the property of Games Workshop Ltd © 1995. All rights reserved.

Games Workshop,
Unit 7/7-9 Kent Road,
(Cnr Church),
Mascot NSW 2020
Australia.



MANUFACTURED
IN THE U.K.

PRODUCT
CODE:
0725