

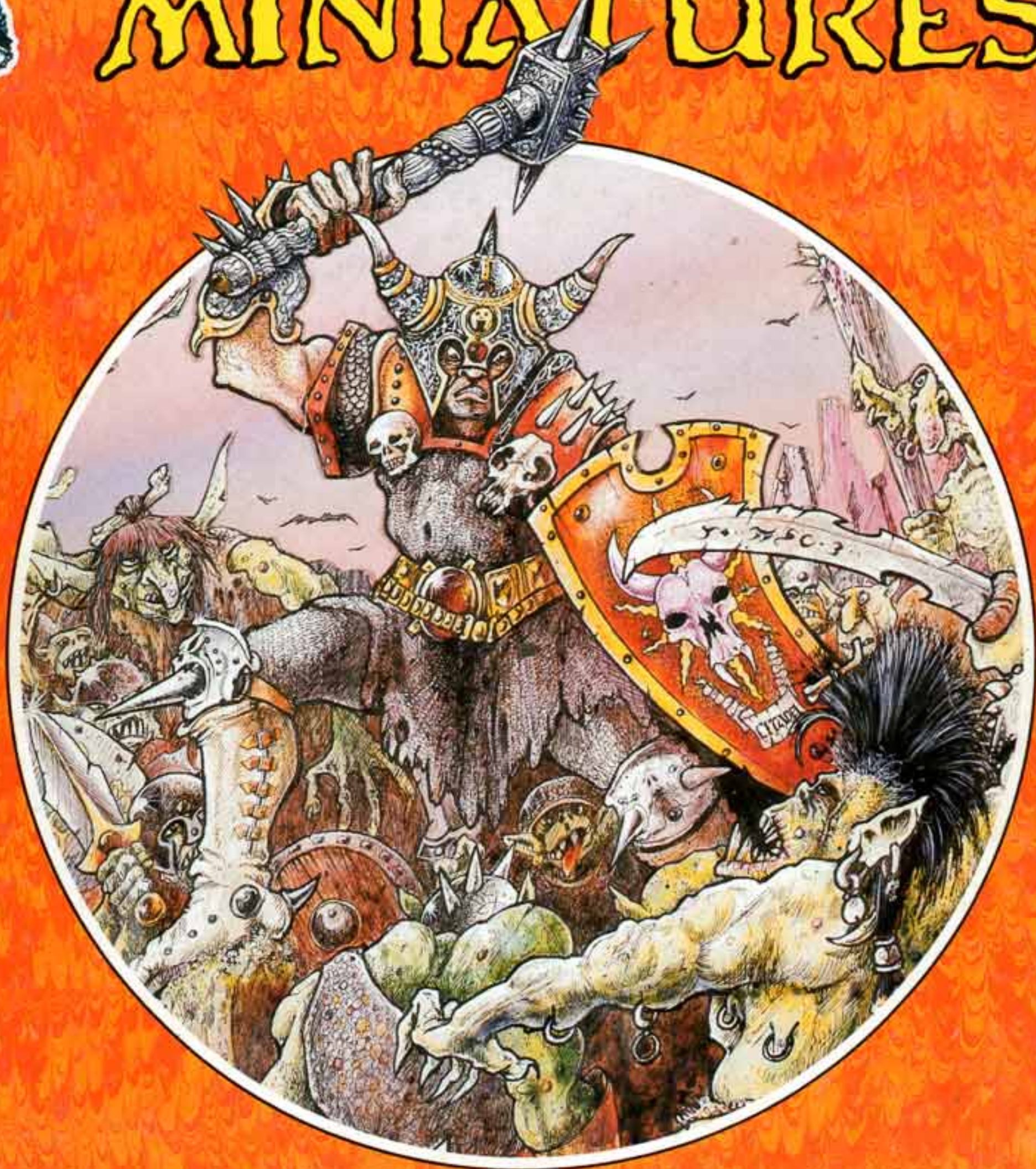

CITADEL MINIATURES™



C A T A L O G U E

PART TWO

PRINTED IN THE U.K. 0718 ISBN: 1 869893 61 1

5 011921 007189



PRICE LIST

SPRING 1989

0001 40mm Monster Base.....	10 for £1.00	0214 Chaos Centaurs.....	2 for £2.50	0512 Man-Mangler.....	£5.95 the set
0001 Horse Base.....	10 for £1.00	0215 Chaos Snakemen.....	2 for £2.50	0701 Goblin Warriors.....	5 for £2.50
0001 Type A Regimental Base.....	10 for £1.00	0215 Whirlwind.....	complete set £3.50	0702 Goblin Warriors.....	5 for £2.50
0001 Type B Regimental Base.....	10 for £1.00	0215 Tenderiser.....	complete set £3.50	0703 Goblin Warriors.....	5 for £2.50
0001 Flying Stand (clear).....	10 for £1.00	0216 Chaos Renegades.....	3 for £2.50	0703 Grom's Goblin Guard.....	£4.99
0001 Display Base.....	10 for £1.50	0217 Chaos Warriors.....	4 for £2.50	(8 troopers & 4 command models)	
0001 Titans Base.....	5 for £1.00	0218 Chaos Champions.....	3 for £2.50	0704 Goblin Javelinmen.....	5 for £2.50
0001 All Other Bases.....	10 for 30P	0219 Chaos Champions.....	3 for £2.50	0704 Goblin Archers.....	5 for £2.50
0001 Plastic Crossbows.....	12 for 60P	0220 Chaos Beastmen.....	5 for £2.50	0705 Goblin Spearmen.....	5 for £2.50
0001 Plastic Spears.....	10 for 50P	0221 Chaos Rider on metal steed.....	£2.50	0705 Goblin Command.....	5 for £2.50
0002 Skeleton Horde boxed set.....	£3.95	0221 Chaos Rider on plastic horse.....	4 for £3.99	0706 Goblin Wolf Riders.....	2 for £2.50
0002 Skeleton Horde individual sprues.....	75P each	0222 Chaos Renegades.....	3 for £2.50	0801 Dragons 01-09.....	£1.95 each
0002 Daleks & Cybermen boxed set.....	£4.95	0223 Chaos Renegades.....		0801 Toad Dragon (10).....	£3.95
0002 Daleks & Cybermen.....		with heavy weapons.....	3 for £2.99	0801 Enraged Dragon (11).....	£2.50
individual sprues.....	75P each	0223 Separate heavy weapons.....	50P each	0802 Emperor Dragon (01).....	£29.95
0002 Psychostyrene Dwarfs.....	3 for 75P	0224 Juggernaut of Khorne.....	£3.50	0802 Spined Dragon (02).....	£15.00
0002 Drastik Plastik Orcs.....	3 for 75P	0224 Individual heads for Juggernauts.....	50P each	0803 Black Dragon (01).....	£6.50
0003 Warhammer 40K Backpacks.....	5 sprues for 75P	0224 Slaanesh Rider on Beast.....	£3.50	0803 Lava Dragon (02).....	£9.95
0003 Plastic Shields.....	10 sprues for 50P	0225 Daemonettes of Slaanesh.....	5 for £2.50	0803 Horned Dragon (03).....	£5.95
0004 Warhammer Regiments boxed set.....	£9.99	0225 Bloodletters.....	4 for £2.50	0803 Nightmare Dragon (04).....	£6.50
0004 Warhammer Regiments.....		0226 Fiends.....	2 for £2.50	0804 Dragon Masters (01).....	£9.95
individual sprues.....	£1.10 each	0226 Fleshhounds.....	2 for £2.50	0804 Orc War Wyvern (02).....	£9.95
0004 Warlock of Firetop Mountain.....		0227 Pink Horrors.....	4 for £2.50	0804 Green Dragon (03).....	£4.95
Set of 6.....	75P	0227 Blue Horrors.....	4 for £2.50	0804 Kegox (04).....	£15.00
0004 Dungeonquest.....	set of 4 for 60P	0228 Greater Daemon of Nurgle.....	£3.50	0805 Dragons 01, 02 & 03.....	£5.95 each
0005 Imperial Space Marines boxed set.....	£9.99	0228 Greater Daemon of Nurgle.....		0805 Oriental Dragon (04).....	£4.95
0005 Imperial Space Marines.....		individual pieces.....	50P each	0805 Great Imperial Dragon (05).....	£14.95
individual sprues.....	75P each	0229 Greater Daemon of Tzeentch.....	£3.50	0806 Zombie Dragon (01).....	£4.95
0006 Citadel Colour Paint Set.....	£5.99	0230 Chaos Renegades.....	3 for £2.50	0806 Large Fire Dragon (02).....	£6.50
0006 Monster Paint Set.....	£5.99	0301 Norse Dwarfs.....	5 for £2.50	0806 Large Red Dragon (03).....	£6.50
0006 Creature Paint Set.....	£5.99	0302 Norse Dwarfs.....	5 for £2.50	0806 Blue Dragon (04).....	£4.95
0006 Expert Paint Set (inks).....	£5.99	0303 Chaos Dwarfs.....	5 for £2.50	0806 Serpentine Dragon (05).....	£3.50
0006 Individual Inks (10ml).....	70P each	0304 Chaos Dwarfs.....	5 for £2.50	0806 Rock Dragon (06).....	£6.50
0006 Individual Black Ink (15ml).....	99P	0305 Dwarf Adventurers.....	5 for £2.50	0901 Fimir.....	£1.95 each
0006 Individual Paints.....	70P each	0306 Dwarf Adventurers.....	5 for £2.50	0902 Ogres.....	£1.95 each
0006 000 Sable Brush.....	£1.00	0307 Imperial Dwarfs.....	5 for £2.50	1201 Wizards.....	5 for £2.50
0006 00 Sable Brush.....	£1.10	0308 Imperial Dwarf Command.....	4 for £2.50	1202 Wizards.....	5 for £2.50
0006 0 Sable Brush.....	£1.30	0308 Dwarf Bolt Thrower.....	£2.50 the set	1301 Skeleton Command.....	4 for £2.50
0006 1 Sable Brush.....	£1.40	0308 Dwarf Flame Cannon.....	£2.50 the set	1301 Skeleton Infantry.....	5 for £2.50
0006 2 Sable Brush.....	£1.60	0309 Dwarf Villagers.....	5 for £2.50	1302 Skeleton Infantry.....	5 for £2.50
0006 3 Sable Brush.....	£1.95	0310 Chaos Dwarf Renegades.....	4 for £2.50	1303 Skeleton Infantry.....	5 for £2.50
0007 Space Dwarf boxed set.....	£9.99	0310 Dwarf Lords of Legend.....	4 for £2.50	1304 Night Horrors.....	5 for £2.50
0007 Space Dwarf individual sprues.....	75P each	0311 Dwarf Engineers - 1 of 07, 14 & 21.....		1305 Night Horrors.....	5 for £2.50
0008 Imperial Guard boxed set.....	£9.99	plus 4 figures.....	for £2.50	1306 Zombies.....	5 for £2.50
0008 Imperial Guard individual sprues.....	75P each	0312 Chaos Dwarf Petard.....		1307 Undead Samurai.....	5 for £2.50
0009 Land Raider boxed kit.....	£6.99	(01, 02, & 03).....	2 for £2.50	1307 Nightmare Legion boxed set.....	£9.99
0010 Rhino boxed set of 3 kits.....	£9.99	0312 Chaos Bazooka (04 & 05).....	2 for £2.50	2001 Blood Bowl Elves.....	5 for £2.50
0011 Predator boxed kit.....	£5.99	0312 Bugman's Cart.....	£3.50 the set	2001 Blood Bowl Goblins.....	5 for £2.50
0012 Battle Titans boxed set.....	£9.99	0312 Bugman's Dwarf Rangers.....	4 for £2.50	2002 Blood Bowl Orcs.....	4 for £2.50
0012 Battle Titan.....		0312 Ulthar's Imperial Dwarfs.....	4 for £2.50	2002 Blood Bowl Assortment.....	5 for £2.50
individual sprue (001205).....	£1.50 each	0401 Elves.....	5 for £2.50	2002 Blood Bowl Ogre.....	£1.95 each
0012 Battle Titan weapon sprues.....	75P each	0402 Wardancers.....	5 for £2.50	2003 Blood Bowl Humans.....	5 for £2.50
0101 Fighters.....	5 for £2.50	0403 Warriors.....	5 for £2.50	2003 Blood Bowl Dark Elves.....	5 for £2.50
0102 Fighters.....	5 for £2.50	0404 Elven Command Group.....	4 for £2.50	2004 Blood Bowl Dwarfs.....	5 for £2.50
0103 Fighters.....	5 for £2.50	0404 Animal Keepers.....		2004 Blood Bowl Minotaur.....	£2.50 each
0104 Fighters.....	5 for £2.50	1 keeper (14, 16, 18 or 20) plus.....		2004 Blood Bowl Ogre and Troll.....	2 for £2.50
0105 Dogs of War.....	5 for £2.50	either 1 bear (17) or 3 other.....		2005 Blood Bowl Skaven.....	5 for £2.50
0106 Paladins.....	5 for £2.50	animals (13, 14, 15).....	for £2.50	2005 Blood Bowl Death Roller.....	£2.50
0106 Lords of Battle.....	5 for £2.50	0405 Cavalry.....	2 for £2.50	2005 Blood Bowl Halflings.....	10 for £2.99
0107 Barbarians.....	5 for £2.50	0405 Guards (07, 09, 15).....	5 for £2.50	2005 Blood Bowl Snotlings.....	18 for £2.99
0108 Barbarians.....	5 for £2.50	0406 Personalities.....	£2.50 each	2006 Blood Bowl Star Players.....	5 for £2.50
0109 Battle Lord & Retainers.....	£2.50 for set of 3	(includes choice of mount + 3 accessories)		3001 Eternal Champion.....	4 for £2.50
0109 Heroic Fighters.....	4 for £2.50	0501 Orc Warriors.....	5 for £2.50	3001 Melniboncan Infantry.....	5 for £2.50
0110 Disciples of Red Redemption.....	5 for £2.50	0502 Orc Warriors.....	5 for £2.50	3002 Pan-Tangian Infantry.....	5 for £2.50
0110 Avenging Knights.....	5 for £2.50	0503 Orcs with Polearms.....	5 for £2.50	3002 Melniboncan Cavalry.....	2 for £2.50
0201 Chaos Warriors.....	4 for £2.50	0503 Orc Bolt Thrower.....	£2.50 the set	3003 Pan-Tangian Tyger Handlers.....	
0202 Chaos Warriors.....	4 for £2.50	0504 Orcs with Dual Weapons.....	5 for £2.50	1 handler + 3 tygers.....	for £2.50
0203 Chaos Warriors.....	4 for £2.50	0504 Brothers Grim.....	£1.99 the pair	3003 Personalities.....	5 for £2.50
0204 Chaos Warriors.....	4 for £2.50	0505 Orc Archers.....	5 for £2.50	3004 Mighty Fortress.....	complete set £19.99
0205 Chaos Beastmen.....	5 for £2.50	0505 Shaman and Generals.....	2 for £2.50	Individual Wall Sections (01,02).....	poa
0206 Chaos Beastmen.....	5 for £2.50	0506 Orc Command Group.....	4 for £2.50	Individual Tower Section (03).....	poa
0207 Chaos Beastmen.....	5 for £2.50	0507 Savage Orcs.....	5 for £2.50	Ladders (04).....	poa
0208 Sorcerers (3) and Familiars (2).....	5 for £2.50	0508 Orc Villagers.....	5 for £2.50	Trapdoors (05).....	poa
0209 Sorcerers (3) and Familiars (2).....	5 for £2.50	0509 Boar Riders.....	2 for £2.50	Doors (06).....	poa
0210 Chaos Thugs.....	5 for £2.50	0510 Orc Champions.....	4 for £2.50	Large Gate (07).....	poa
0211 Chaos Thugs.....	5 for £2.50	0510 Harboth's Orc Archers.....	4 for £2.50		
0212 Chaos Thugs.....	5 for £2.50	0511 Orc Crossbowmen.....	4 for £2.50		
0213 Chaos Thugs.....	5 for £2.50	0511 Ruglud's Armoured Orcs.....	4 for £2.50		
		0512 Notlob's Orc Artillery.....	£2.50 the set		

4001 Imperial Guard.....5 for £2.50
 4002 Imperial Guard.....5 for £2.50
 4003 Imperial Guard
 with heavy weapons.....3 for £2.50
 4003 Heavy Weapons.....5 for £2.50
 4003 Rapier.....£3.50 the set
 4004 Pirates and Adventurers.....5 for £2.50
 4005 Pirates and Adventurers.....5 for £2.50
 4006 Medics.....3 for £2.50
 4006 Medics on Bikes.....£2.50 each
 4006 Vincent Black Shadow & Sidecar.....£2.50 set
 4007 Mercenaries.....5 for £2.50
 4007 Jet-Cycles.....2 for £2.50
 4008 Devastators
 complete boxed set (01, 02, & 03)....for £9.99
 Individual Machines (01).....£4.99
 (02).....£2.50
 (03).....£2.50
 4009 Robots.....£2.50 each
 4010 Imperial Guard Commissars.....4 for £2.50
 4010 Imperial Guard Beastmen.....5 for £2.50
 4010 Imperial Guard.....6 for £2.99
 4011 Adeptus Mechanicus
 1 Adeptus & 2 Servitors.....for £2.50
 4011 Imperial Guard, wounded.....6 for £2.99
 4011 Imperial Guard Ratlings.....6 for £2.99
 4012 Imperial Guard Rough Riders.....4 for £3.99
 4101 Marines.....3 for £2.50
 4102 Marines.....3 for £2.50
 4103 Marines with heavy weapons.....3 for £2.50
 4103 Metal Marine Backpacks.....10 for £2.50
 4103 Marine with Multi Melta.....£1.50 the set

4103 Imperial Commander.....£2.50 the set
 4104 Imperial Dreadnought.....£3.50 each
 Set comprises of:
 1 body (10 or 11)
 2 shoulder blocks
 2 legs (16 & 17 or 18 & 19)
 2 arms (07, 08, 12, 13)
 plus 40mm plastic base (14,15)
 4105 Techmarines.....3 for £2.50
 4105 Techmarine on bike.....£2.50
 4105 Terminator Squad
 boxed set of 8 models.....£9.99
 4105 Terminator Squad
 individual models.....£1.50 each
 4106 Chaplains.....3 for £2.50
 4106 Chaplain on bike.....£2.50
 4106 Terminator Marines.....£1.25 each
 4106 Death Eagle Marines.....3 for £2.50
 4201 Squat Command Group.....6 for £2.99
 4201 Squat Warriors.....6 for £2.99
 4202 Squat Warriors.....6 for £2.99
 4203 Squat Bikes & Trikes.....2 for £2.99
 4203 Squat Heavy Weapons Trike.....£2.99
 4204 Squats.....6 for £2.99
 4204 Squat Tech Priest.....99P
 4204 Squat Exo-armour.....99P
 4301 Eldar Command Group.....4 for £2.50
 4301 Eldar Warriors.....5 for £2.50
 4302 War Machines.....£3.50 each
 Warwalker (01) includes choice of pilot
 (09 or 10)

Spirit Warrior (02) includes choice of
 Ghost Warrior (03 or 04)
 4303 Dreadnoughts (01, 02 & 03).....£3.50 each
 NB - The Eldar War Machines and
 Dreadnoughts have interchangeable guns, and it
 is possible to freely substitute these between
 the models to achieve a "custom" look. Thus it
 is possible to order a War Walker (4302 01)
 with pilot (4302 09) and 2 x missile
 launchers (4303 15).
 Similarly, the arms of the Dreadnoughts and
 Spirit Warriors are interchangeable. Please
 specify arms and/or weapons when ordering.
 4304 Eldar Field Artillery
 2 gunners + 2 guns.....for £2.50
 4304 Eldar D-cannon.....£2.50 the set
 4305 Harlequins.....6 for £2.99
 4306 Harlequins.....6 for £2.99
 4306 Eldar Jet Bike.....£2.50
 4306 Harlequin Jet Bike.....£2.50
 7001 Reaver Battle Titan.....£3.95
 7001 Warhound Scout Titans.....2 for £2.50
 7002 Eldar Titan.....£3.99
 7002 Dreadnoughts/Walkers/Spirit Warriors.....
8 plus 1 Field Artillery for £2.50
 7002 Land Raiders.....2 for £2.50
 7002 Rhinos.....5 for £2.50
 7002 Imperial Dreadnoughts.....
8 plus 1 Marine on bike for £2.50
 7002 Robots.....10 for £2.99

INFORMATION

HOW TO MAIL ORDER FROM THE CATALOGUE

Each miniature has a unique six-digit number. The first four digits of this number are the same as the four-digit code for the Catalogue page on which the miniature appears. The last two digits are specific to that miniature.

Using these numbers when ordering direct from the Games Workshop and Citadel Mail Order service will enable us quickly to identify the models you want and help us to process your order efficiently.

Simply quote the relevant numbers and use the prefix "CATALOGUE" eg. CATALOGUE, 010403, 010407 & 010409.

ABOUT CITADEL MINIATURES

The models we make are intended for collectors, modellers and as playing pieces for serious gamers.

THEY ARE NOT TOYS

Our metal models contain LEAD which can be harmful if ingested, but there is no real danger if you are sensible. Please follow these simple instructions:

- Please do not put them in your mouth or lick them.
- Do not buy them for or give them to small children.

Our miniatures should certainly never be given to children under 12, nor to older children who you cannot trust not to suck them.

Certain of the models within the Catalogue are cast as multi-part kits. These are designed to be assembled in as simple a fashion as possible. However, they can prove to be quite difficult to assemble, especially by young or inexperienced modellers. We therefore recommend that only experienced modellers should attempt these models.

CLEANING AND PREPARATION

On any metal casting a certain amount of cleaning and preparation work will be necessary before painting. This is especially true on multi-piece castings which will require careful filing and trimming to enable a neat finish on the joints.

Sometimes small pieces of excess metal like a 'halo' will be apparent around the edge of a figure. This is called 'flash' and can easily be trimmed off with a modelling knife. Please be very careful when handling modelling knives, which are very sharp. Work on a firm surface, preferably wood, and always cut away from yourself.

You may also find small slivers of metal extending from the figure on areas such as elbows and feet. Again, these can be easily trimmed off with a modelling knife and smoothed over with a rat-tailed file.

Glue the figure onto the slottabase as soon as you have finished cleaning it as this allows easier handling of the figure for painting. For gluing together any metal parts we suggest

a 5 minute epoxy resin glue or similar adhesive.

Once your figure is glued together, a little filing may be necessary to get rid of the excess glue. You may also wish to fill areas around joints to hide a join completely. Many two-part fillers are available from hobby stores.

You should not have to mix great quantities of filler (if you don't mix enough, you can always mix some more!) and use it sparingly. Get rid of any excess with a damp cloth while the filler is still wet. Again, don't be in a rush, and wait for the filler to dry before any final cleaning up.

Your figure is now ready for undercoating. We suggest you use a spray primer such as car spray or alternatively you can use Citadel primer or white emulsion. **DO NOT APPLY TOO MUCH** and if you are using spray, either use it outside or in well a ventilated room with plenty of protection behind, above, below and to the sides of the figure.

For painting your figure we recommend Citadel colour paints, as they are specially formulated to compliment our own figure ranges. They are non-toxic water-based paints, so you can clean your brushes in water and mix the paint with Citadel inks.

After you have painted your figure you will need a coat of varnish to protect it from the wear and tear of gaming use and general mis-handling. Gloss varnish protects the figure better than matt varnish, but some people prefer the latter's duller and more realistic finish. Whatever type of varnish you decide to use, make sure that it is clear and not tinted or stained such as used for wood.

You will find regular articles in WHITE DWARF magazine detailing methods and means of converting and painting your figures. Written by our own artists and figure collectors, they are full of useful advice.

SLOTTABASES AND PLASTIC SHIELDS

The majority of our models are supplied with these plastic accessories. Slottabases are covered fully on the relevant page of the Catalogue. Plastic shields are supplied with those miniatures which are illustrated with them. Additional shields can be ordered separately (see price list).

MAIL ORDER ADDRESS & PHONE NUMBERS

Please send all orders to the following address:

GAMES WORKSHOP MAIL ORDER SERVICE
 CHEWTON STREET, HILLTOP,
 EASTWOOD, NOTTINGHAM NG16 3HY

Mail Order phone numbers: (0773) 760462 and (0773) 713213

FAX No: 0773 530155

PRODUCT CODE: 00718g

ISBN: 1 869893 61 1

A GAMES WORKSHOP publication

Printed in the UK by: Clearpoint Press Ltd.,
 Nottingham, England

GAMES WORKSHOP LTD.

Chewton Street

Hilltop, Eastwood

Nottingham, NG16 3HY

GAMES WORKSHOP INC.

3431 Benson Avenue

Baltimore

Maryland 21227

Copyright © 1989 Games Workshop Ltd. All rights reserved.



CITADEL PLASTICS

PLASTIC BASES



We now produce a variety of different size and shape slottabases.
The simple key below indicates which bases are suitable for use with each range.

Each base has a pre-cut groove to accept the tab cast-on to each miniature. Some tabs may require a small amount of filing or trimming to fit the base. Do not force the model on as this may break the model or the base. Apply glue to the tab on the model and fix to the slottabase as shown.

Slottabases are generally included in the price of the models and are normally supplied with the same base type as illustrated in the photograph. The exceptions to this are the Display Plinth, Metal Oval base and Regimental bases (Type A and B) which must be ordered separately at an additional charge. However, the regimental bases may be supplied *instead* of regular bases at no additional cost on a 3 to 1 basis. For example 15 orcs with 5 regimental bases Type B cost the same as 15 Orcs supplied with 15 square bases.

Throughout this catalogue the base symbols illustrate exactly which bases are suitable for use with any particular range of models. Please note that models cannot be adequately supported on bases for which they are not designed. Indicate your choice of base when ordering. Unless otherwise instructed models will be supplied with the bases they have been photographed with.

Certain models in our range are designed either to not require a base at all or are cast with an integral metal base. These models are noted with this symbol 

Regimental base A is suitable for use with all codes marked with the  symbol, base B is suitable for use with all codes marked with the  symbol.

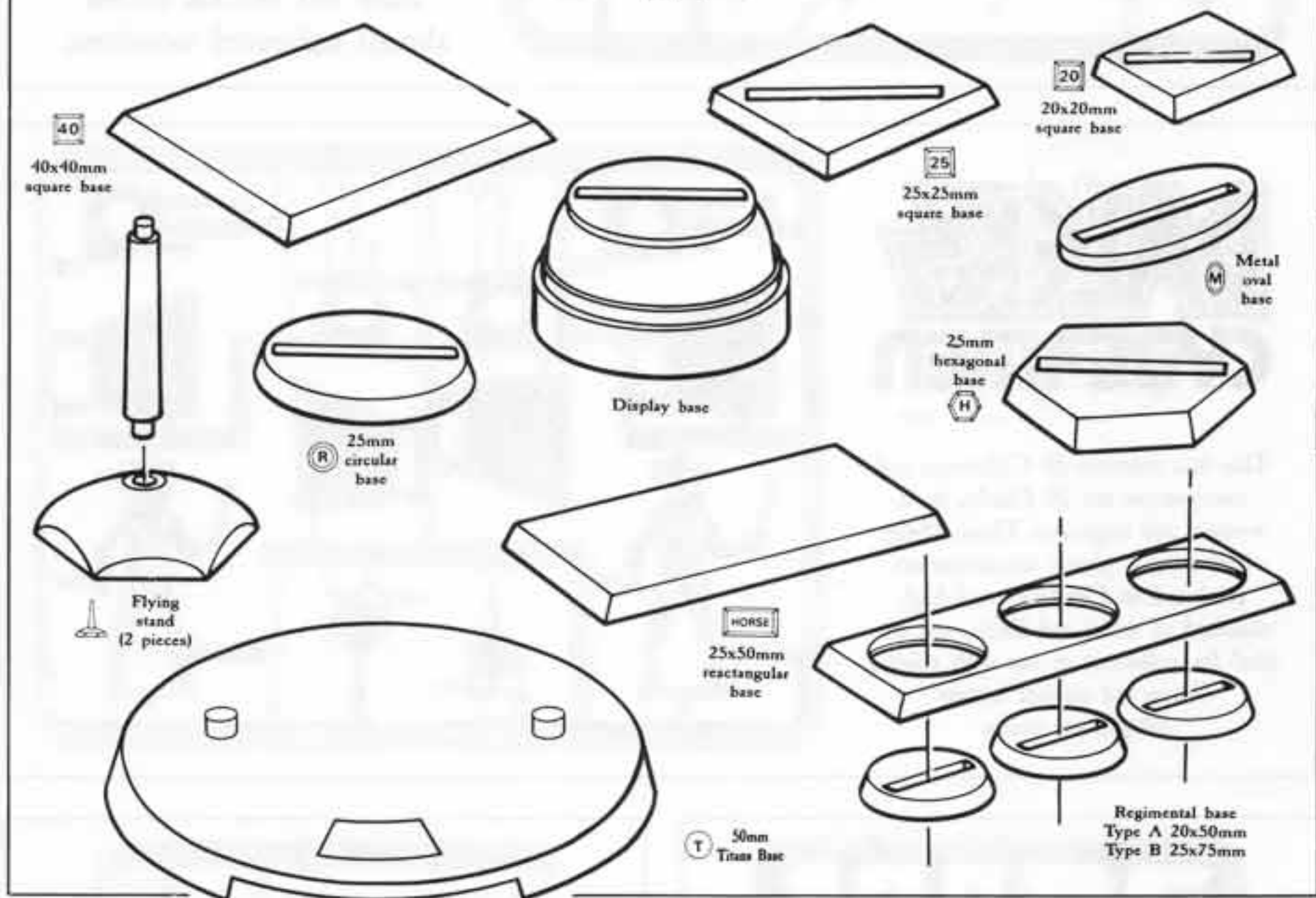

01

PLASTIC CROSSBOWS

Each crossbow is moulded in hard styrene plastic, which affixes easily to the hands of Citadel's new crossbowmen, or to the backs of any other figures, giving them awesome fire power.



02

PLASTIC SPEARS

Designed for use with Elf cavalry and infantry, and moulded in hard styrene plastic, each finely sculpted spear can easily be fixed in place to allow a more realistic 3 dimensional effect.

CITADEL PLASTICS

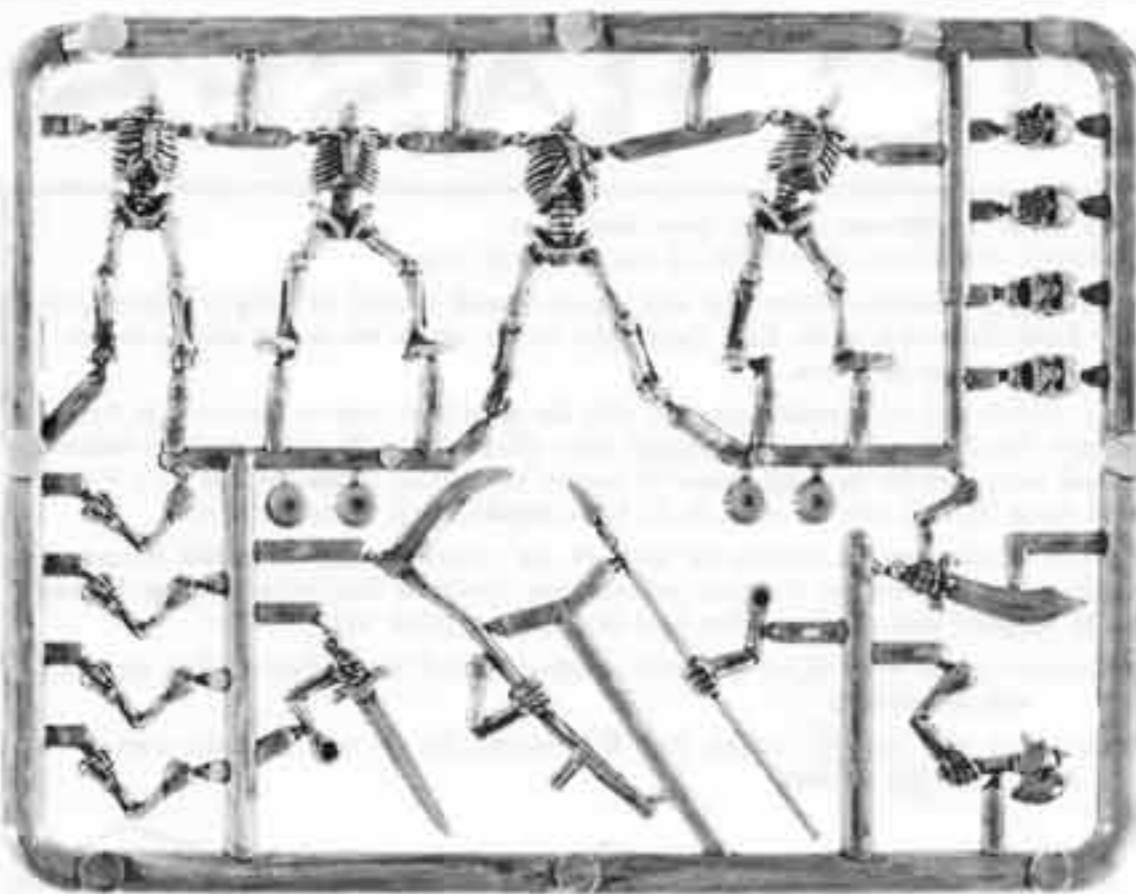

SKELETON HORDE

01

This box contains 6 sprues of superbly detailed hard styrene plastic components, with enough parts to assemble 24 Skeleton models. Supplied with shields and bases. The range of body positions, heads, arms and shields allows almost unlimited variations.

DALEKS CYBERMEN

02

This box contains 20 Cybermen and components for 20 Daleks, both warriors and engineers. These 25mm hard styrene plastic miniatures are produced to Citadel's usual high standard of detail and finish, and are ideal for collectors or use with science fiction and science fantasy roleplaying games.

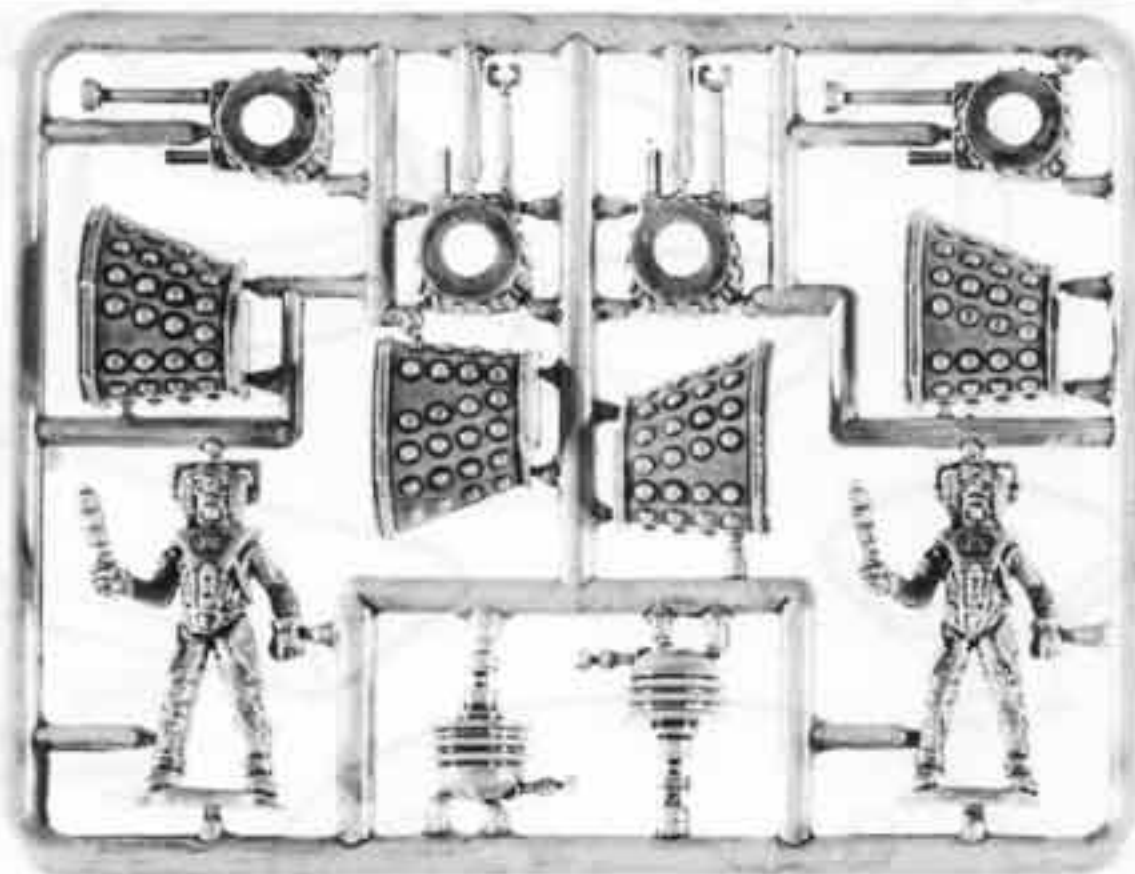

psychostyrene DWARFS

03



DRASTIK PLASTIC ORCS

04

CITADEL PLASTICS

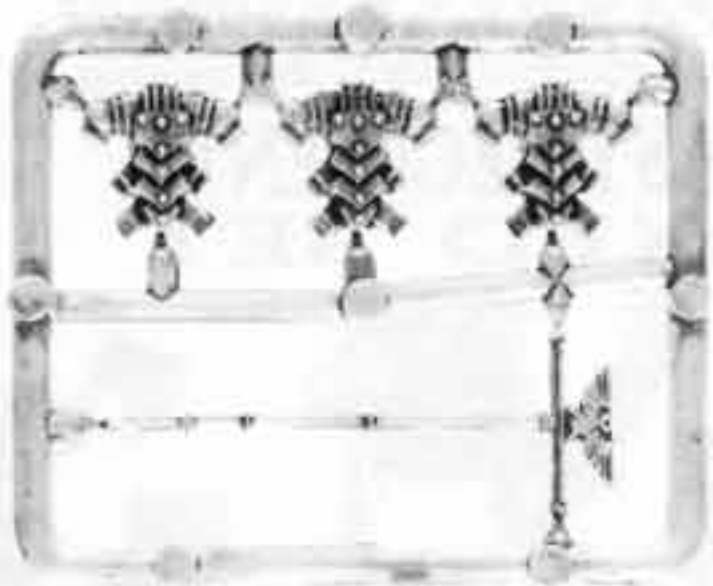

**MARINE
BACKPACKS
& STANDARD**

01

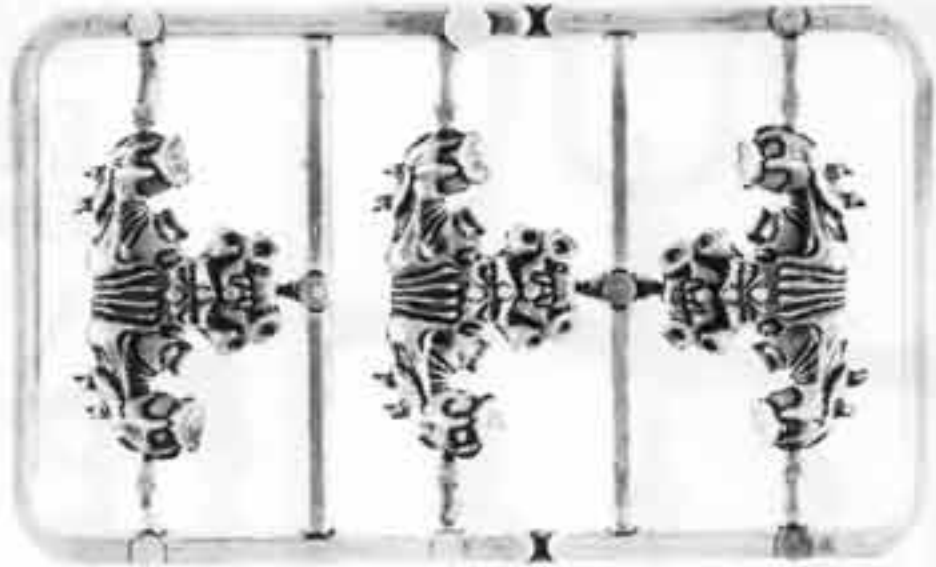

**CHAOS
BACKBACKS**

02

PLASTIC SHIELDS



03

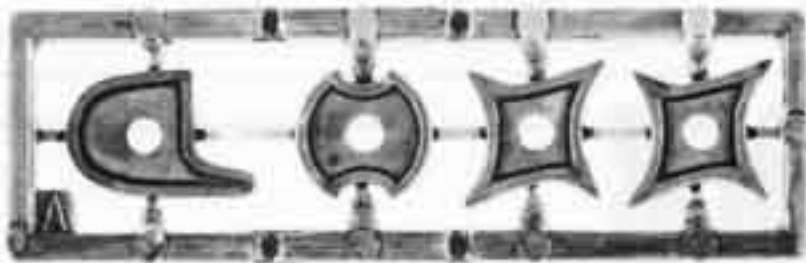

04

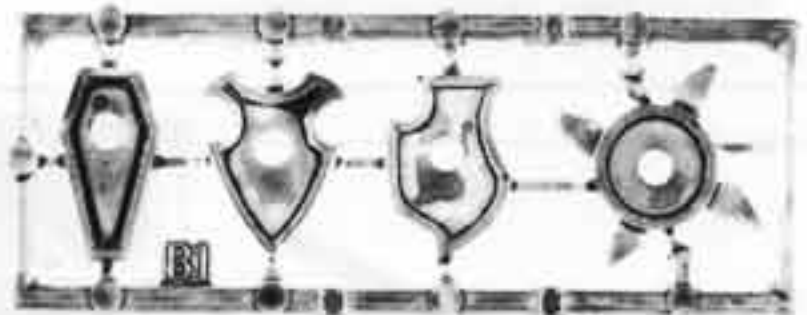

05

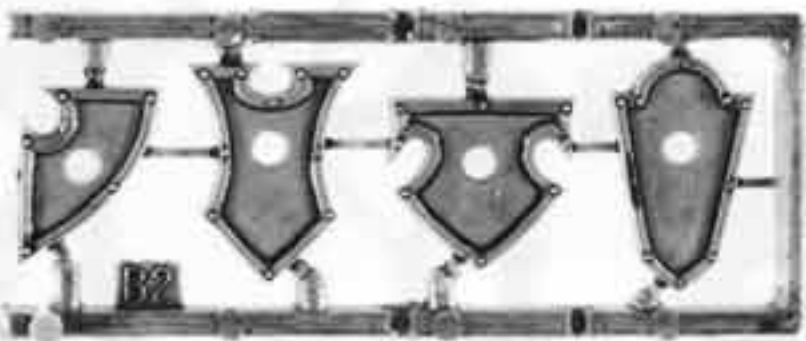

06

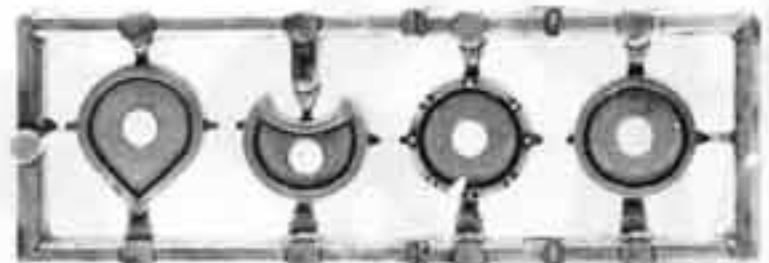

07

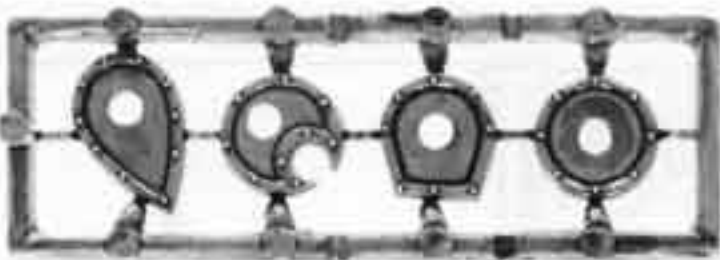

08

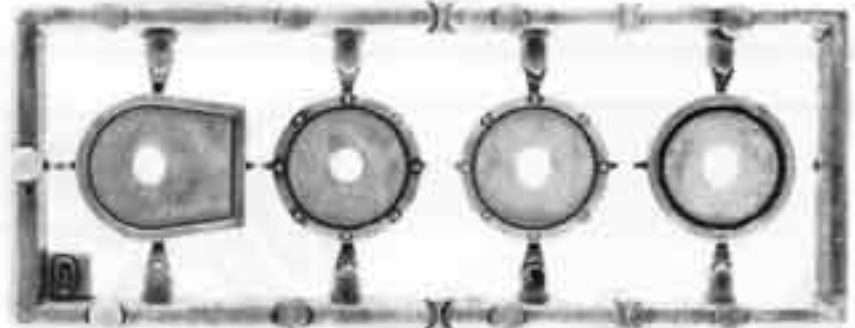

09

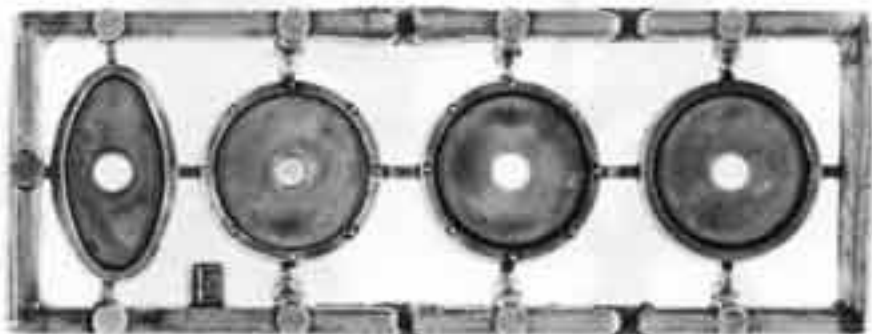

10



11

MODEL REQUIRES ASSEMBLY AND IS SUPPLIED UNPAINTED. NOT RECOMMENDED FOR CHILDREN UNDER 3 YEARS OF AGE DUE TO SMALL PARTS.



CITADEL PLASTICS

WARHAMMER™

FANTASY REGIMENTS BOXED SET



01

WARHAMMER FANTASY REGIMENTS contains 10 each of the following races: ORCS, DARK ELVES, DWARFS, GOBLINS, ELVES and SKAVEN. Complete with 60 bases, 50 regimental shields and optional heads for each model, plus optional weapons for Dwarfs, Orcs and Skaven.

THE WARLOCK OF FIRETOP MOUNTAIN



02

DUNGEONQUEST



03

CITADEL PLASTICS

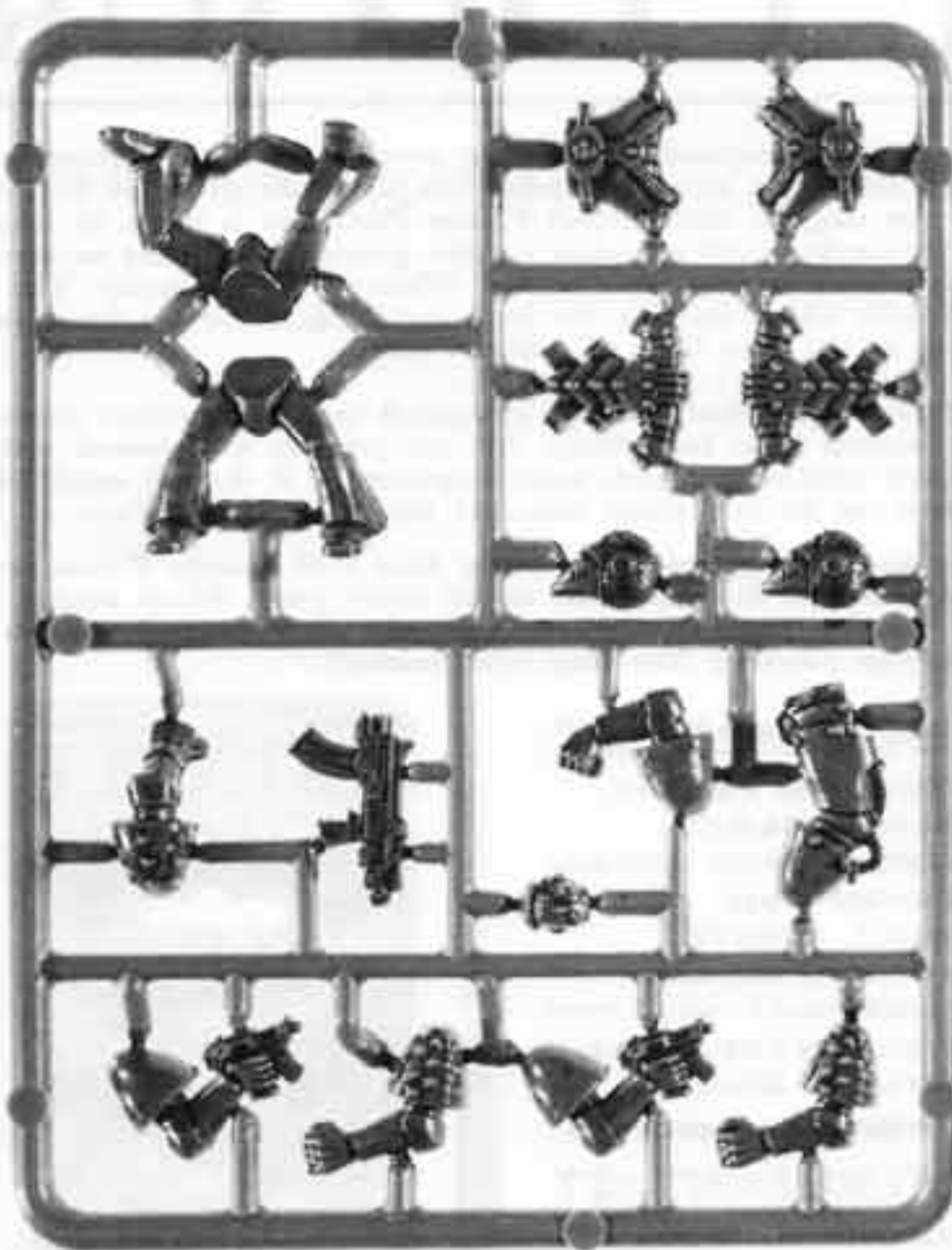

02 BASIC MARINES

IMPERIAL SPACE MARINES

THIS BOX CONTAINS 17 SPRUES OF HIGHLY DETAILED HARD STYRENE PLASTIC COMPONENTS, WITH ENOUGH PIECES TO CONSTRUCT 30 MARINE MODELS. THESE INCLUDE HEAVY WEAPON OPERATIVES WITH MISSILE LAUNCHERS AND FLAMERS, AS WELL AS PERSONALITY MODELS. ALSO INCLUDED ARE CLOSE COMBAT WEAPONS, KNIFE AND WHIRRING BLADES, DESIGNED TO BE ATTACHED TO BOLT GUNS, AND 30 PLASTIC BASES.

01

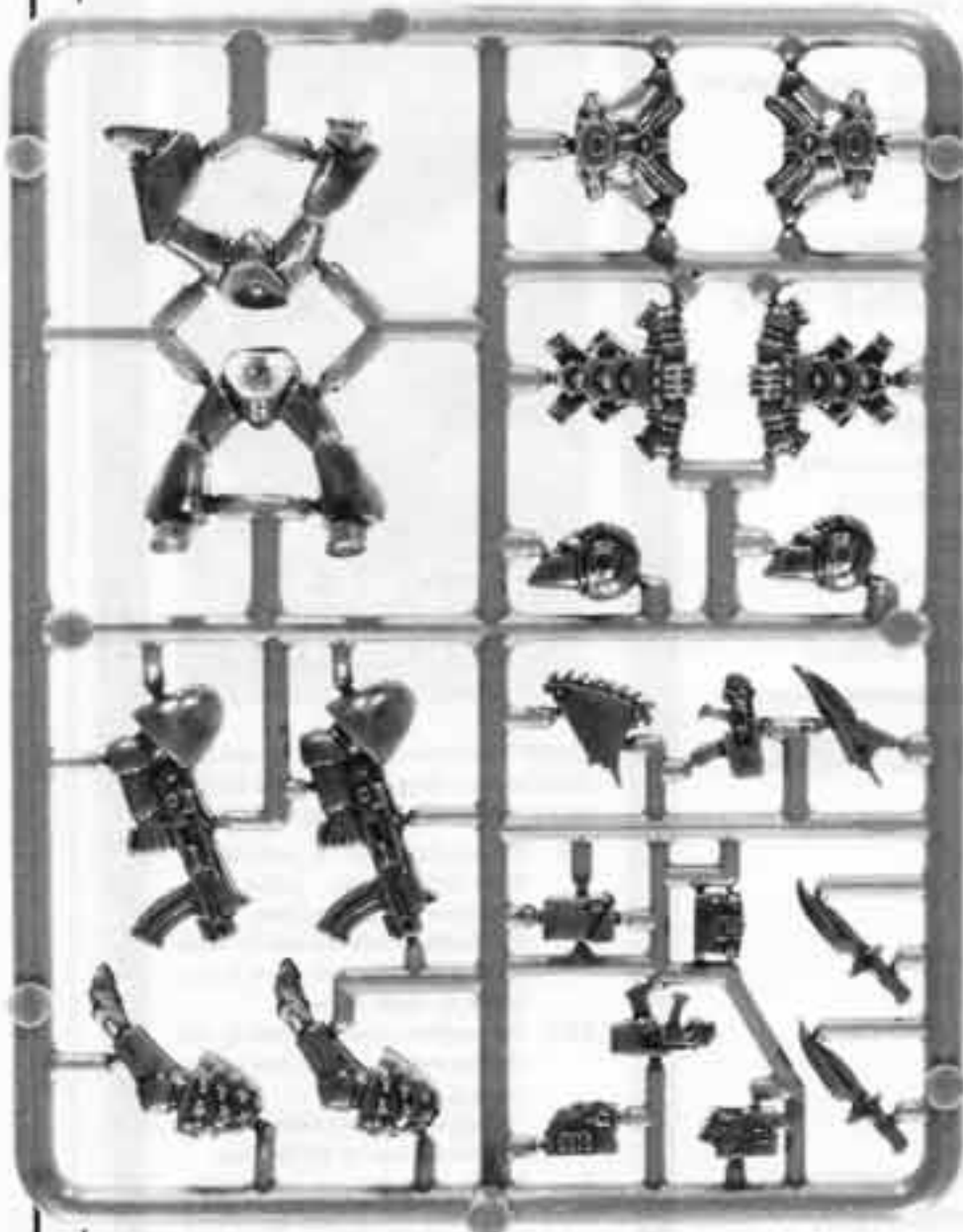

03 CLOSE COMBAT

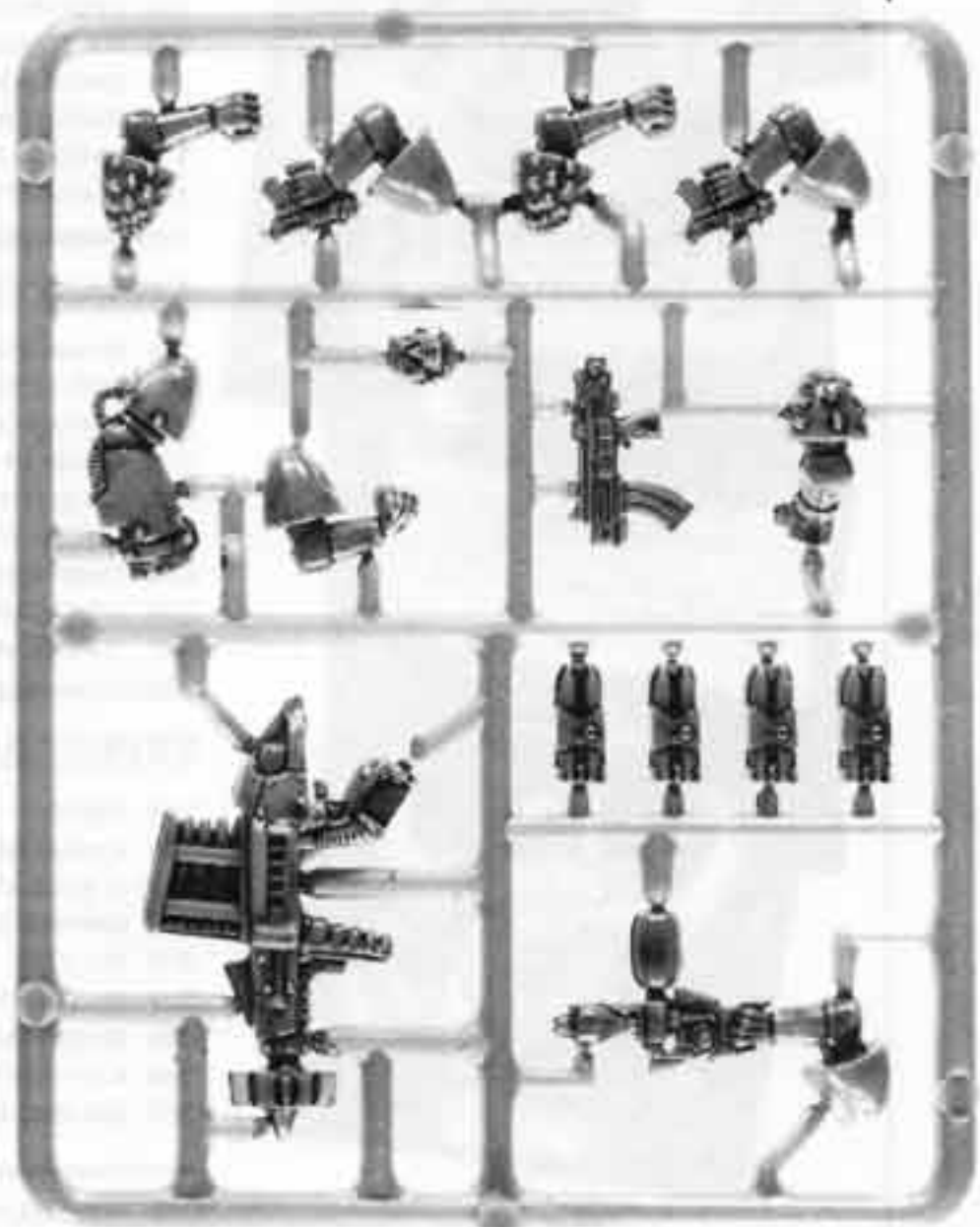

04 HEAVY WEAPONS

MODEL REQUIRES ASSEMBLY AND IS SUPPLIED UNPAINTED. NOT RECOMMENDED FOR CHILDREN UNDER 3 YEARS OF AGE DUE TO SMALL PARTS.



CITADEL
MINIATURES

Copyright © 1989 Games Workshop Ltd. All rights reserved.

0005

PAIN T

CITADEL COLOUR

Citadel Colour Acrylic paints and inks are specially designed for painting metal and plastic miniatures. All colours are fully intermixable, enabling the discerning artist to render that *just right* shade of Goblin snot or Troll dribble. The latest addition to the range is the Citadel Expert Paint Set, a range of inks specially designed to complement the Citadel acrylics, and intended for the painter who wants to give his figures that special 'Citadel' look so often seen in the pages of the *White Dwarf* magazine. The transparent layer of colour that may be added with ink is suitable for both enriching existing colours and adding a stage of shading to the base layer of Citadel acrylic.

Citadel Colour acrylic paints contain more pigment and less medium compared to other, inferior paints, giving denser coverage, better mixability and superb value for money. All our paint is water-based, and non-toxic, so brushes and palettes can be cleaned with water. And, most importantly, it doesn't smell like a snotling's loincloth, which is more than can be said about some of the mail order trolls...

Don't forget, all models benefit from a proper undercoating before painting. Use P28 Smelly Power or a light coat of matt white enamel or cellulose paint of the type sold as car body paint. Many model shops sell spray cans of paint ideally suited for this purpose. Colours will only show properly if you undercoat your models before painting. You have been warned!



COLOUR PAINT SET

- 01 BRONZED FLESH
- 02 CHAOS BLACK
- 03 WOODLAND GREEN
- 04 BLOOD RED
- 05 SKULL WHITE
- 06 SHINING GOLD
- 07 SUNBURST YELLOW
- 08 ENCHANTED BLUE
- 09 MITHRIL SILVER

CREATURE PAINT SET

- 10 SWAMP BROWN
- 11 ROTTING FLESH
- 12 ORC BROWN
- 13 HOBGOBLIN ORANGE
- 14 ELF GREY
- 15 SPEARSTAFF BROWN
- 16 WORM PURPLE
- 17 GOBLIN GREEN
- 18 CHAINMAIL

MONSTER PAINT SET

- 19 BRAZEN BRONZE
- 20 BILIOUS GREEN
- 21 GHOUL GREY
- 22 BESTIAL BROWN
- 23 ELECTRIC BLUE
- 24 RED GORE
- 25 IMPERIAL PURPLE
- 26 MOODY BLUE
- 27 TITILATING PINK

EXPERT PAINT SET (INKS)

- 29 RED
- 30 ORANGE
- 31 YELLOW
- 32 GREEN
- 33 BLUE
- 34 PURPLE
- 35 BROWN
- 36 CHESTNUT
- 37 BLACK

28 SMELLY PRIMER



Citadel Brushes are numbered from size 000 (finest) to size 3 (largest). Each of the brushes has a particular use in the painting of miniatures.

- 000 For very fine detail - in particular, for black-lining edges, picking out equipment and painting eyes.
- 00 For detailed brushwork and for small areas of blending such as on a face, banner or shield design.
- 0&1 For medium areas of blending and shading, and for applying base colours to small areas.
- 2 For large areas of base colours and small to medium areas of dry-brushing.
- 3 For the base colours on larger figures, such as monsters, Dragons and vehicles, and for dry-brushing and washing medium-large areas.

CITADEL PLASTICS

SPACE DWARFS

MERCENARIES OF THE 41ST MILLENNIUM



000704

THIS BOX CONTAINS ENOUGH PLASTIC SPRUES TO MAKE 36 SPACE DWARF MERCENARY WARRIORS. THESE PLASTIC KITS INCLUDE BASES AND VARIOUS WEAPONS WHICH ALLOW FOR A VAST RANGE OF POSES AND MODELLING OPTIONS

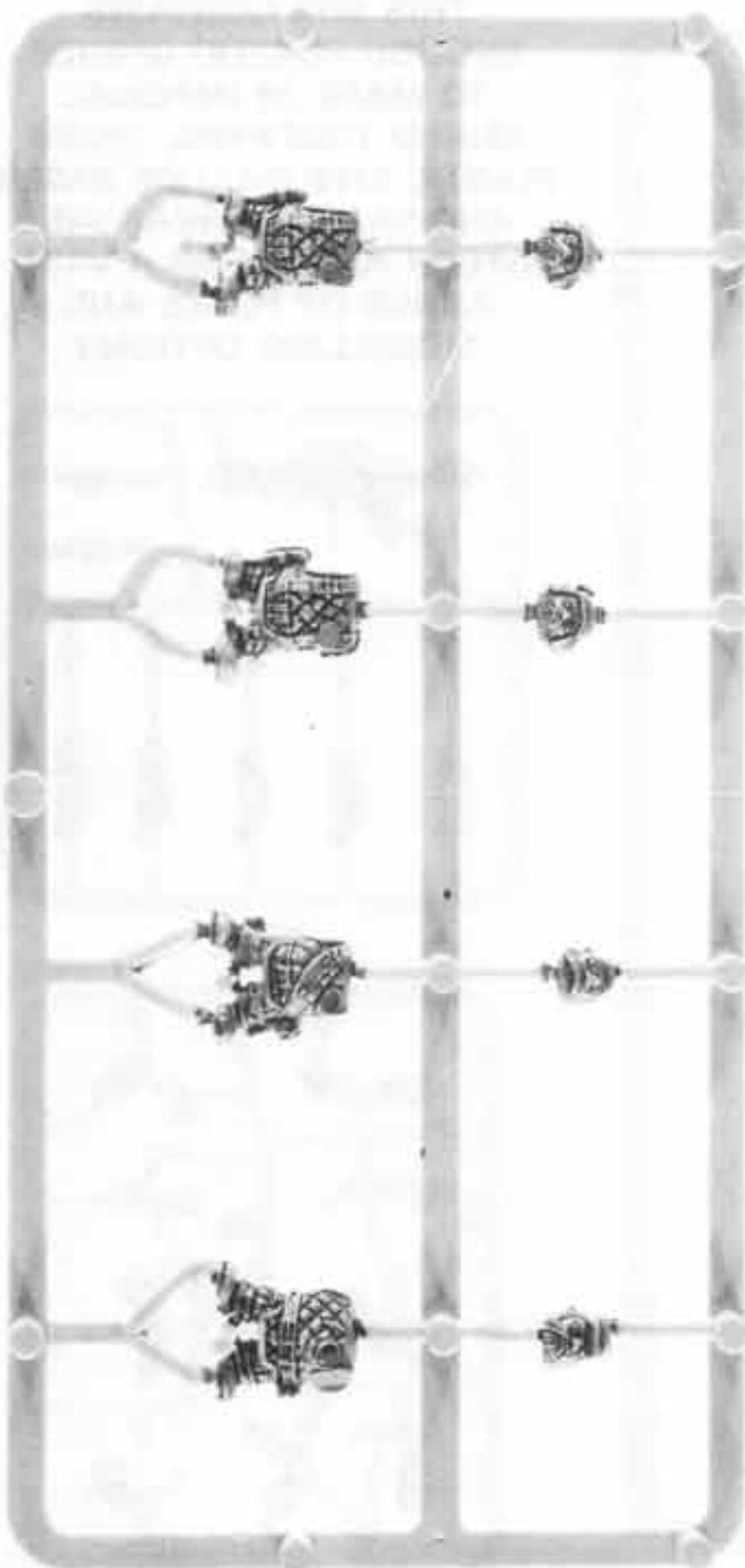

000701
BODIES



000703
WEAPONS

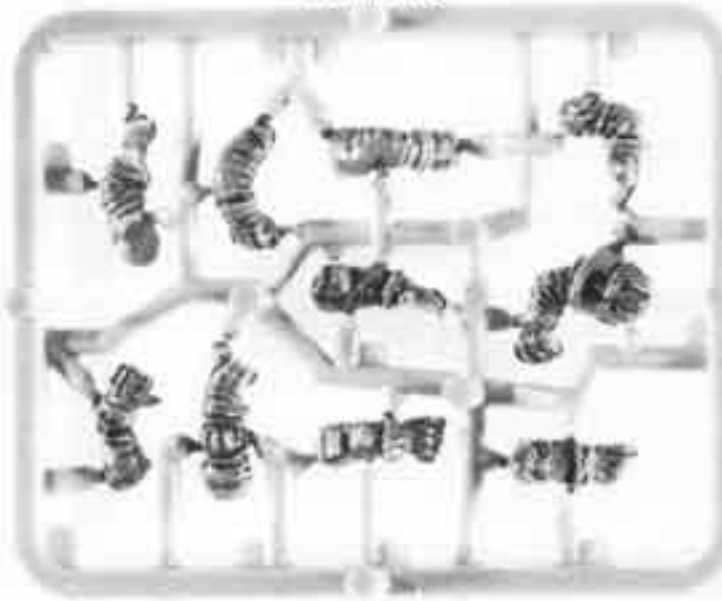

000702
ARMS

MODEL REQUIRES ASSEMBLY AND IS SUPPLIED UNPAINTED. NOT RECOMMENDED FOR CHILDREN UNDER 3 YEARS OF AGE DUE TO SMALL PARTS.



CITADEL
MINIATURES

CITADEL PLASTICS



BOXED SET
000801

THIS BOX CONTAINS ENOUGH PLASTIC SPRUES TO MAKE 36 IMPERIAL GUARD TROOPERS. THESE PLASTIC KITS INCLUDE BASES AND VARIOUS WEAPONS WHICH ALLOW FOR A VAST RANGE OF POSES AND MODELLING OPTIONS



000802
BODIES



000804
WEAPONS



000803
ARMS



CITADEL PLASTICS

LANDRAIDER

BRING THE FORMIDABLE FIREPOWER OF IMPERIAL MAIN BATTLE TANKS TO YOUR TABLETOP. WITH CITADEL'S PLASTIC LAND RAIDER KIT YOU CAN ASSEMBLE TWO HIGHLY DETAILED 41ST MILLENNIUM TANKS, COMPLETE WITH TWO HEAVY BOLTERS, DUAL MOUNTED LAS-CANNONS AND IMPERIAL INSIGNIA.

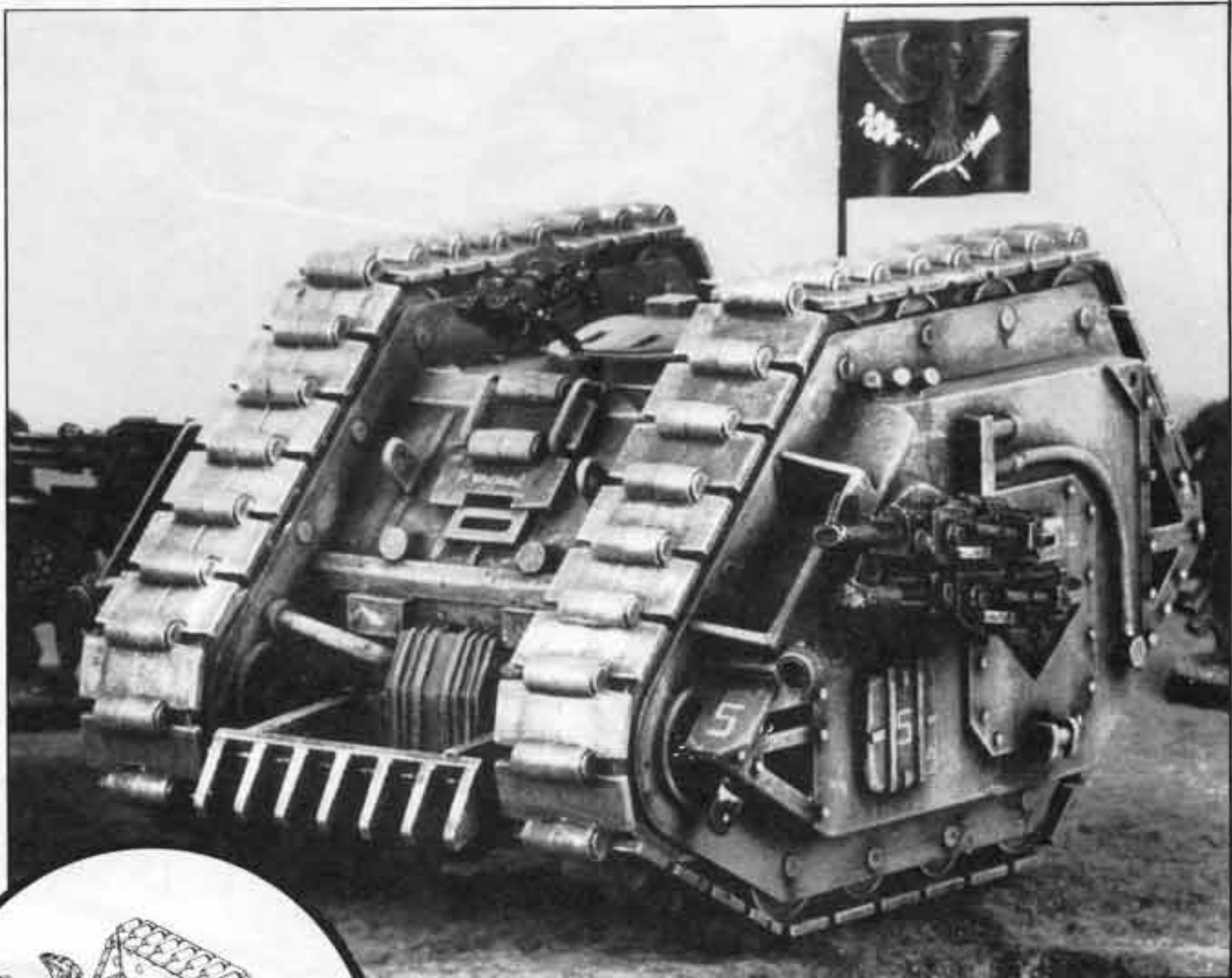

000901

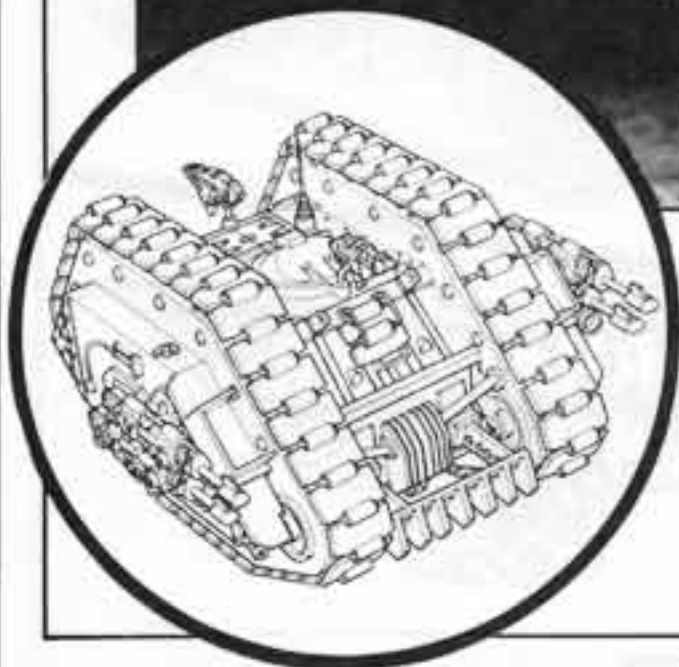

Copyright © 1989 Games Workshop Ltd. All rights reserved.

0009

MODEL REQUIRES ASSEMBLY AND IS SUPPLIED UNPAINTED. NOT RECOMMENDED FOR CHILDREN UNDER 3 YEARS OF AGE DUE TO SMALL PARTS.

CITADEL
MINIATURES

CITADEL PLASTICS

RHINO

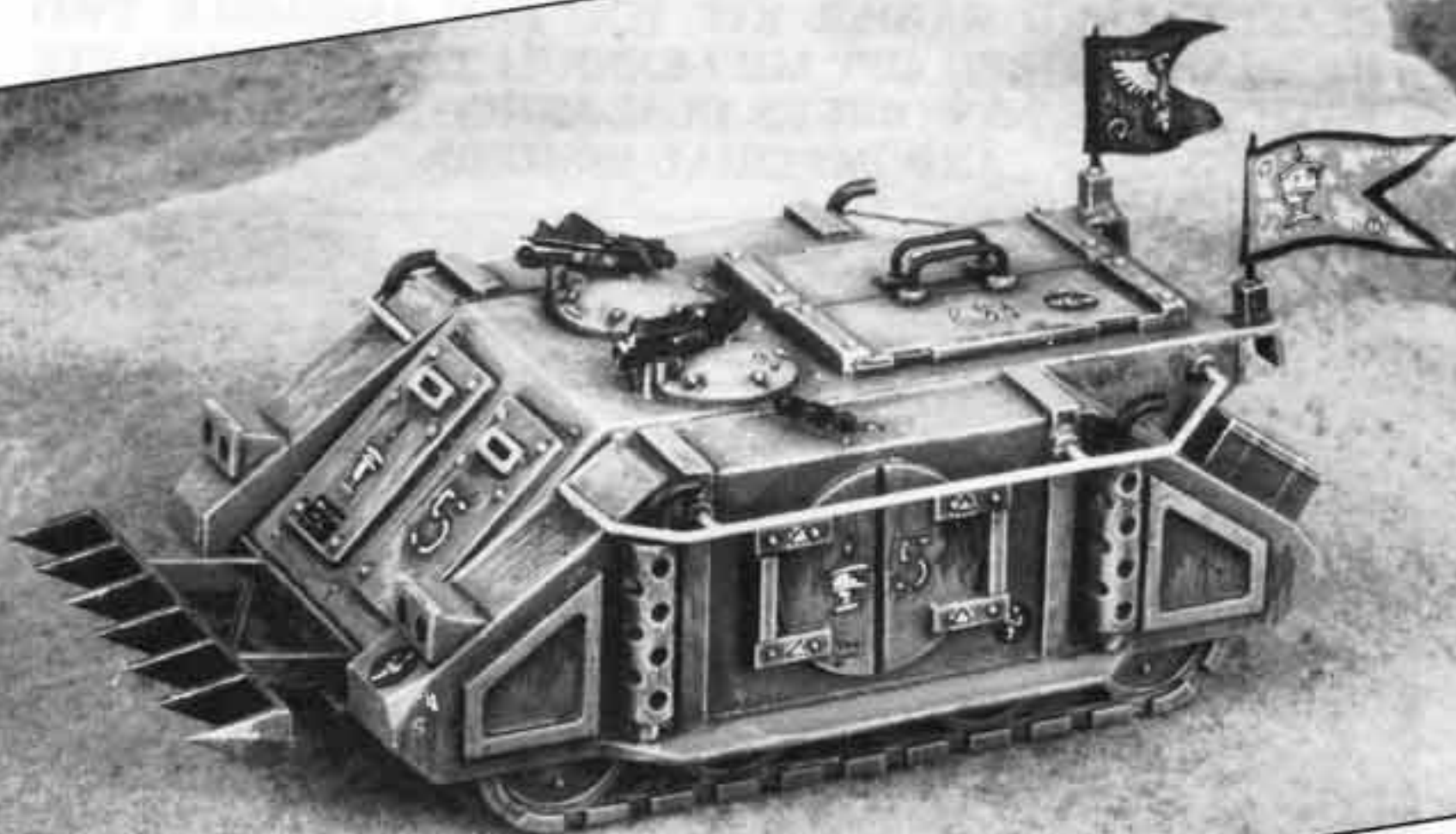

Boxed Set No: 001001

This highly detailed kit comes complete with multi-purpose body sections, optional hatches, open or closed crew compartments, separate commander's hatches (with boltguns), engine exhausts, smoke and grenade launchers, spiked ram attachment, and external accessories such as light fittings and handrails. And each Rhino can be built in a variety of ways - reflecting the multiplicity of roles filled by this mighty machine.

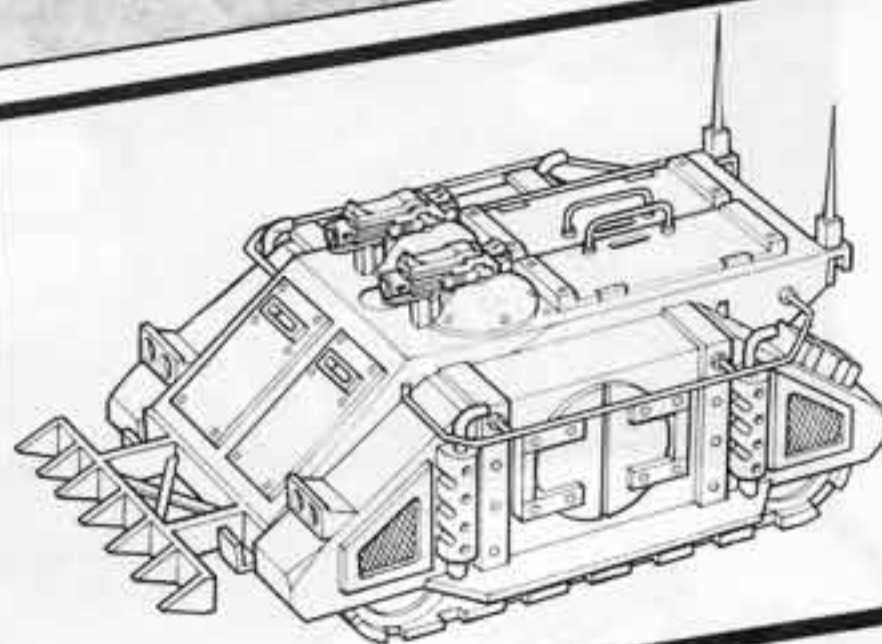

WARHAMMER
40,000



CITADEL PLASTICS

THE PREDATOR

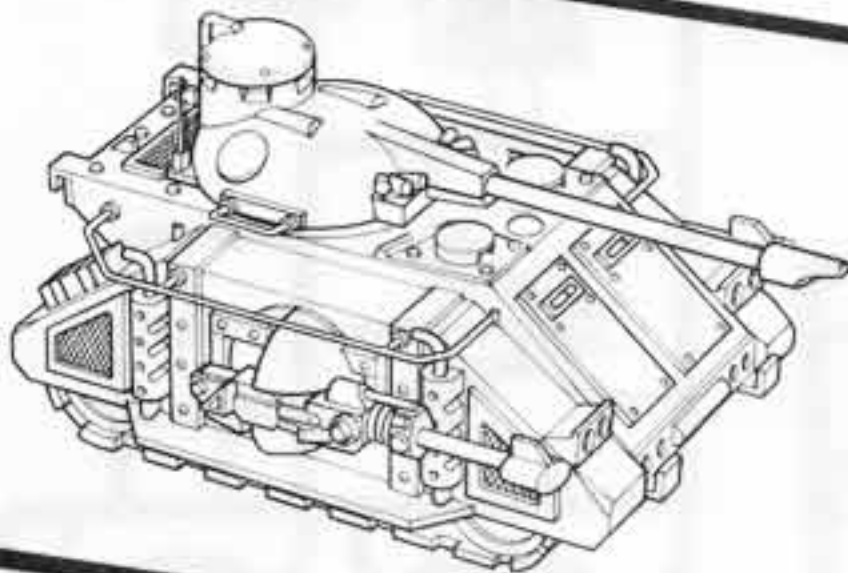
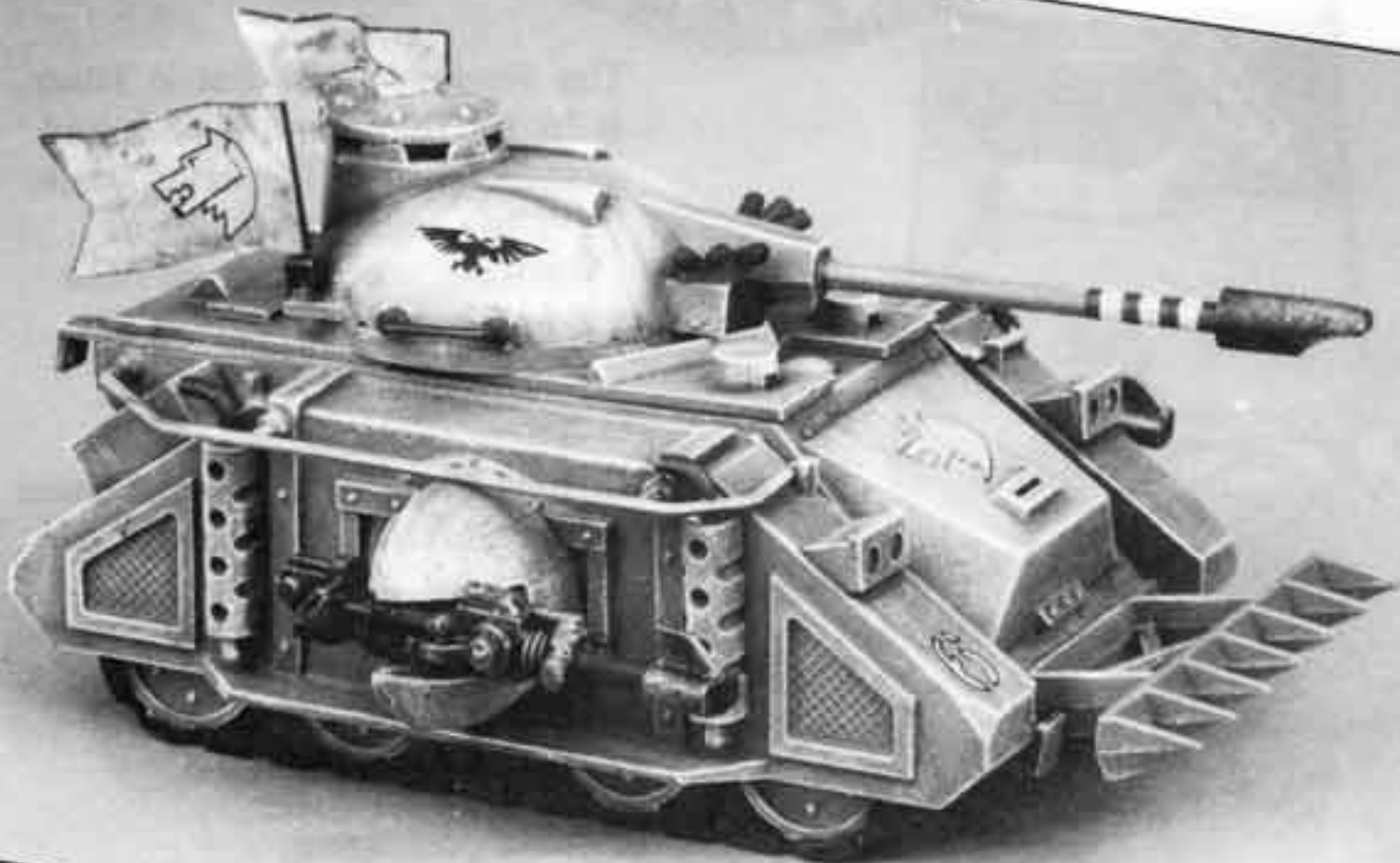

Boxed Set No: 001101

The Predator is the Imperium's assault tank combining highly effective firepower with mobility. Designed around the standard Rhino APC chassis, the Predator is armed with a pair of las-cannon and a turret-mounted auto-cannon. It is widely used by both the Space Marines and the Imperial Guard as an assault vehicle, breaking through enemy lines at the head of the advancing troops or moving rapidly across the battlefield using its heavy firepower to stop the enemy dead.

The Predator is a detailed hard plastic kit.

MODEL REQUIRES ASSEMBLY AND IS SUPPLIED UNPAINTED. NOT RECOMMENDED FOR CHILDREN UNDER 3 YEARS OF AGE DUE TO SMALL PARTS.



CITADEL
MINIATURES

Copyright © 1989 Games Workshop Ltd. All rights reserved.

0011

CITADEL PLASTICS



CONTAINS SIX BATTLE TITANS

BOXED SET
001201

The Warlord Class Battle Titan is by far the most popular and versatile class of Imperial Battle Titan, and thousands of Warlords saw action on both sides during the wars of the Horus Heresy.

These clip-together plastic Warlord Class Battle Titans come with interchangeable weapons.

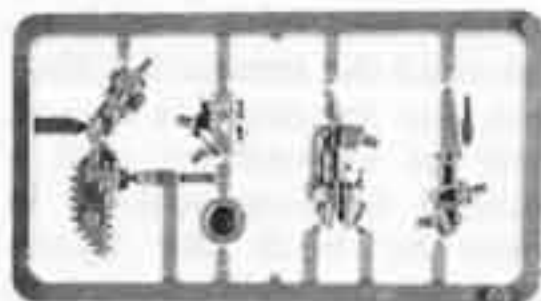
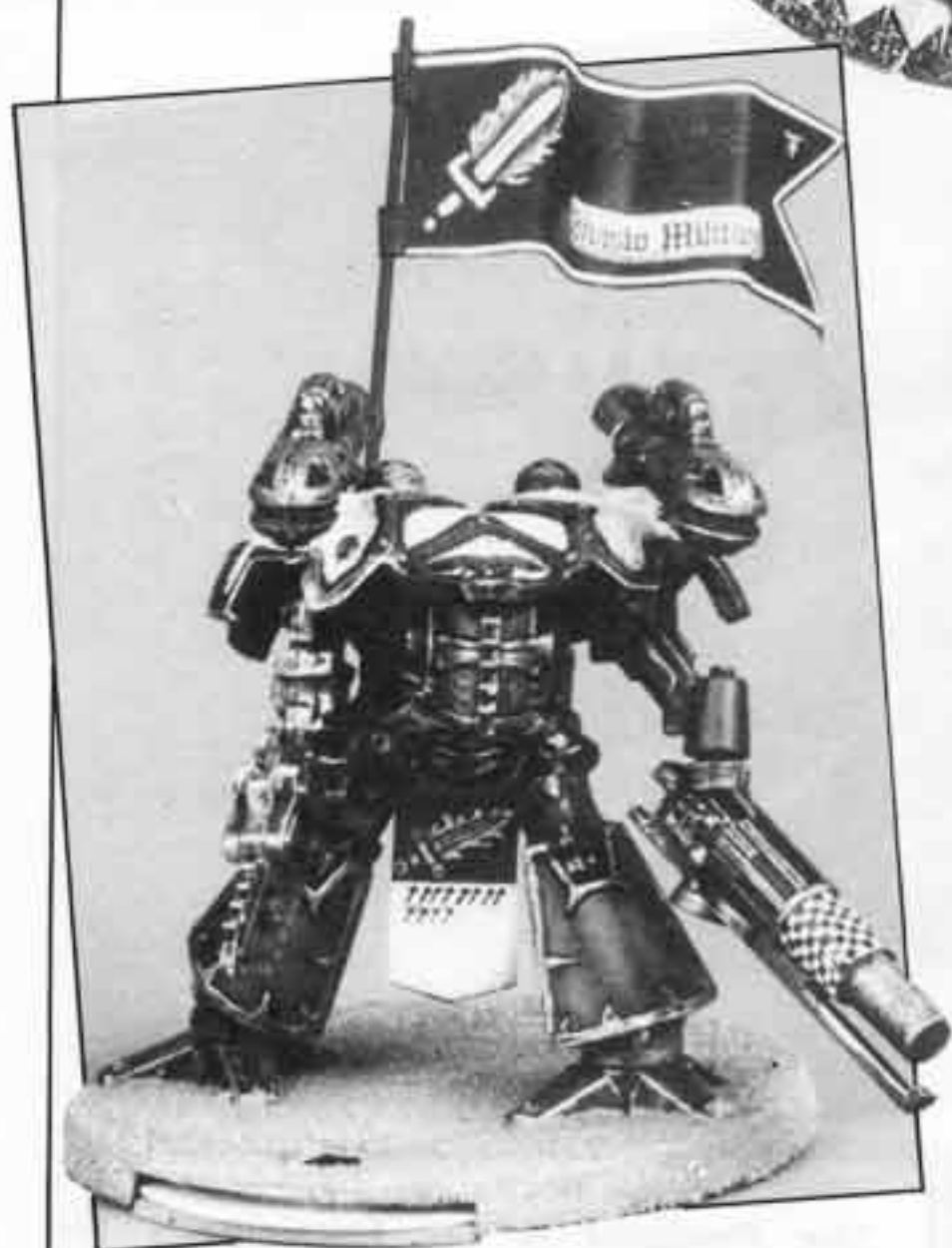

001203



001202



001204

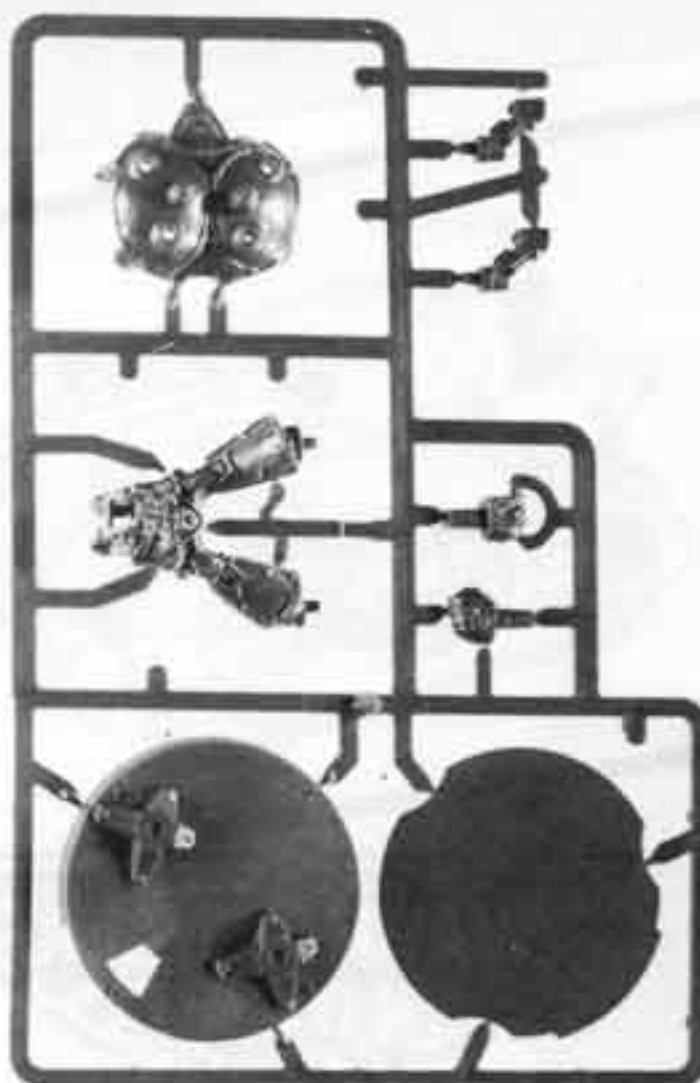

001205

MODEL REQUIRES ASSEMBLY AND IS SUPPLIED UNPAINTED. NOT RECOMMENDED FOR CHILDREN UNDER 3 YEARS OF AGE DUE TO SMALL PARTS.

REALM OF CHAOS

CHAMPIONS

Designed by Jes Goodwin

25 H R M



021901

021902

021903

021904

021905

021917

021908

021907

021911

021913

021914

021906

021910

021916

021912

021915

021910

021916

021909

021918

021919

021920



Figures supplied unpainted. **WARNING!** This product contains lead which may be harmful if chewed or swallowed. Citadel Miniatures are not recommended for children under 12 years of age.



REALM OF CHAOS

BEASTMEN

Designed by
Jes Goodwin



022002

022005

022006

022001

022004

022003

022024

022020

022008

022019

022022

022016

022023

022010

022009

022015

022011

022021

022007

022017

022013

022014

022012

022018

Copyright © 1989 Games Workshop Ltd. All rights reserved.

REALM OF CHAOS

CHAOS STEEDS & RIDERS

Designed by Tish Morrison,
Nick Bibby, Michael & Alan Perry

CHAOS KNIGHTS CONSIST OF SEPARATE BODY & LEG SECTIONS AND CAN BE MOUNTED ON EITHER METAL CHAOS STEEDS OR PLASTIC HORSES. SEE PAGE 4012 FOR PLASTIC HORSE NUMBERS

CHAOS KNIGHT
022107



CHAOS KNIGHT LEGS
022109



CHAOS KNIGHT
022108



CHAOS KNIGHT
022105



CHAOS KNIGHT
022106



CHAOS KNIGHT
022104



CHAOS STEED
022102



CHAOS STEED
022103

CHAOS STEED
022101



JUGGERNAUT OF KHORNE RIDERS & SLAANESH RIDERS CAN ALL BE MOUNTED ON ABOVE METAL CHAOS STEEDS OR PLASTIC HORSES USING CHAOS KNIGHT LEGS.

RENEGADE
022402



RENEGADE
022401



CHAMPION
022403



RENEGADE
022405



CHAMPION
022424



RENEGADE
022404



RENEGADE
022406



Figures supplied unpainted. WARNING! This product contains lead which may be harmful if chewed or swallowed. Citadel Miniatures are not recommended for children under 12 years of age.



WARRIOR
MINIATURES

REALM OF CHAOS

CHAOS RENEGADES

Designed by Michael Perry
& Kevin Adams



022217



022219



022220



022221



022222



022218



022209



022216



022213



022208



022210



022203



022207



022215



022205



022204



022211



022212



022206



022214



022201



022202

MODELS SUPPLIED WITH CHAOS BACKPACK

Copyright © 1989 Games Workshop Ltd. All rights reserved.

REALM OF CHAOS

CHAOS RENEGADES HEAVY WEAPONS

Designed by Michael Perry



022314



022315



022316

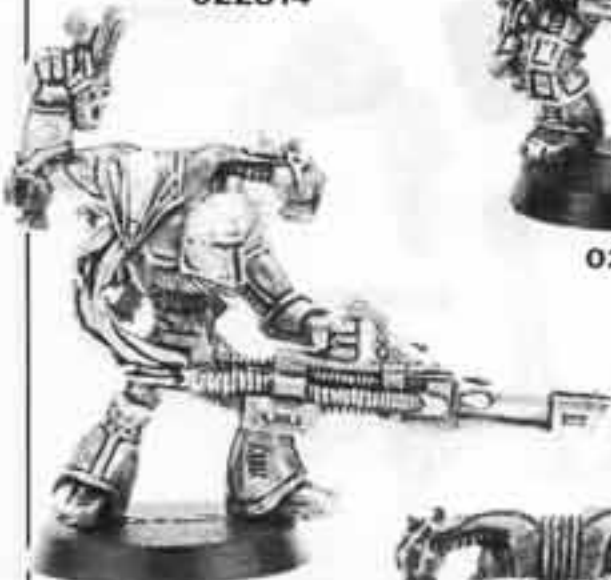

022301



022317



022318



022302



022303



022306



022304



022305

MODELS SUPPLIED WITH CHAOS BACKPACK

HEAVY WEAPONS

Designed by Michael Perry



MULTI MELTA
022307



GRENADE LAUNCHER
022312



HEAVY BOLTER
022308



MISSILE LAUNCHER
022310



CONVERSION BEAMER
022313



LAS-CANNON
022309



HEAVY PLASMA GUN
022311

Copyright © 1989 Games Workshop Ltd. All rights reserved.

WARNING! This product contains lead which may be harmful if chewed or swallowed. Citadel Miniatures are not recommended for children under 12 years of age.



REALM OF CHAOS



MODELS REQUIRE ASSEMBLY

JUGGERNAUTS OF KHORNE

Designed by Jes Goodwin & Alan Perry

RENEGADE LEGS
022407

022404
RENEGADE

022405
RENEGADE

022406
RENEGADE

022403
CHAMPION

022424
CHAMPION

CHAMPION LEGS
022408

022409

022410

022411

HEADS



022413



022412



022416



022417

BANNER POLES



022418



022419



022420

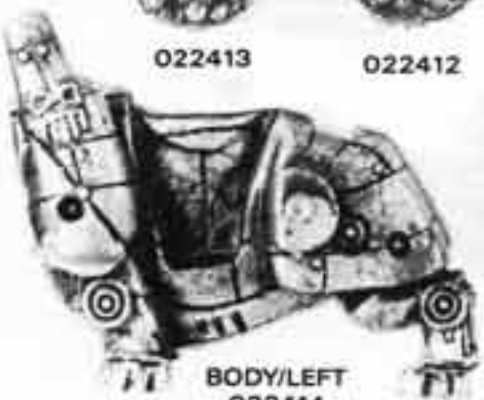

BODY/LEFT
022414



BODY/RIGHT
022415



022422
SWORD

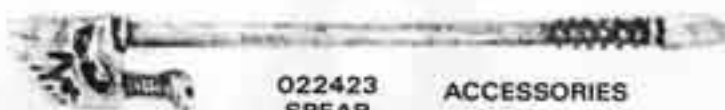

022423
SPEAR

ACCESSORIES



022412
BOW & ARROWS

MODELS REQUIRE ASSEMBLY
RIDING BEAST CONSISTS OF
SEPARATE HEAD, BODY & LEGS

SLAANESH RIDERS

Designed by Alan Perry

022402
CHAOS
RENEGADE



022425



022424

022401
CHAOS
RENEGADE



RIDING BEAST
HEADS
HEADS SUPPLIED RANDOMLY



LEGS SUPPLIED RANDOMLY

REALM OF CHAOS

DAEMONETTES OF SLAANESH

Designed by
Jes Goodwin & Mike Perry

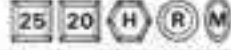

022501



022502



022503



022504



022505



022506



022507



022508



022509



022510



022511



022512



022513

REQUIRES ASSEMBLY. MODELS
SUPPLIED WITH RANDOMLY
ASSORTED LEG SECTION.

BLOODLETTERS LESSER DAEMONS OF KHORNE

Designed by Alan Perry



022521



022522



022524



022523



022525

Figures supplied unpainted. **WARNING!** This product contains lead which may be harmful if chewed or swallowed. Citadel Miniatures are not recommended for children under 12 years of age.



REALM OF CHAOS



HEAD
022602

FIENDS
HUNTING BEASTS OF SLAANESH

Designed by Mike Perry





HEAD
022603



HEAD
022604

HEAD
022605





HEAD
022601

SUPPLIED WITH RANDOM
BODY AND LEGS

MODELS REQUIRE ASSEMBLY



FLESHOUNDS
HUNTING BEASTS OF KHORNE

Designed by Kev Adams





022624

MODELS REQUIRE ASSEMBLY

EXAMPLES OF FLESHOUNDS





022625



022621



022623



022622



ALL MODELS SUPPLIED WITH RANDOM HEADS

REALM OF CHAOS

PINK HORRORS LESSER DAEMONS OF TZEENTCH

Designed by Kevin Adams

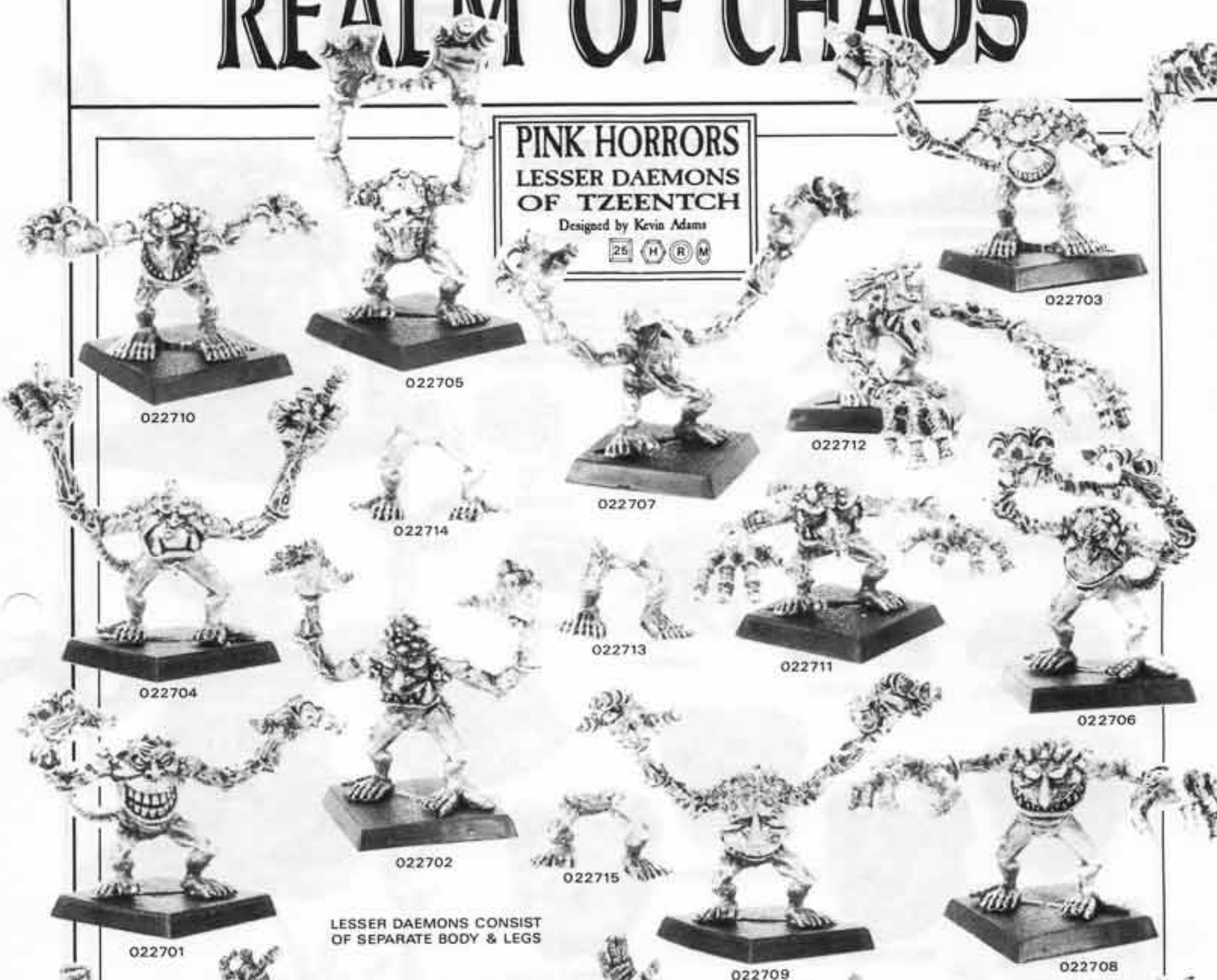

022710

022705

022703

022712

022707

022714

022713

022711

022706

022704

022702

022715

022701

LESSER DAEMONS CONSIST
OF SEPARATE BODY & LEGS

022709

022708

BLUE HORRORS LESSER DAEMONS OF TZEENTCH

Designed by Kevin Adams



022724

022727

022720

022726

022731

022725

022728

022729

022721

022730

022719

022722

022718

022723

022716

022717

Figures supplied unpainted. WARNING! This product contains lead which may be harmful if chewed or swallowed. Citadel Miniatures are not recommended for children under 12 years of age.



REALM OF CHAOS

GREATER DAEMON OF NURGLE

Designed by Aly Morrison

40

Contains: 1 HEAD, 1 BODY BACK
1 BELLY, 1 CHEST
1 RIGHT ARM, 1 LEFT ARM,
1 SET OF LEGS & 1 SET OF HORNS



HORNS 022801



022802



022803



022804

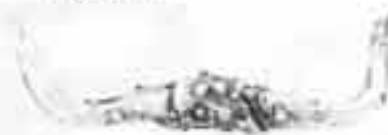

022805



CHEST 022812



CHEST 022813



BELLY FRONT 022814



BELLY FRONT 022815



BELLY FRONT 022816



BELLY FRONT 022817



RIGHT ARM
022821



LEFT ARM 022819



RIGHT ARM
022822



LEFT ARM 022818



LEFT ARM 022823



RIGHT ARM 022820



LEGS 022824



LEGS 022825



EXAMPLE



EXAMPLE



EXAMPLE



BODY BACK
022811



EXAMPLE



EXAMPLE

REALM OF CHAOS

GREATER DAEMON OF TZEENTCH

Designed by Michael Perry

40

Contains 1 HEAD, 1 BODY,
TAIL & WINGS

HEADS
022901



022902



022903



022904



022906



022905



WINGS 022907



TAIL 022908



TAIL 022909



BODY 022910



BODY 022911



BODY 022912



EXAMPLES



Figures supplied unpainted. **WARNING!** This product contains lead which may be harmful if chewed or swallowed. Citadel Miniatures are not recommended for children under 12 years of age.

REALM OF CHAOS

RENEGADES

Designed by Michael Perry

25 H R M



023001



023006



023002



023004



023003



023005

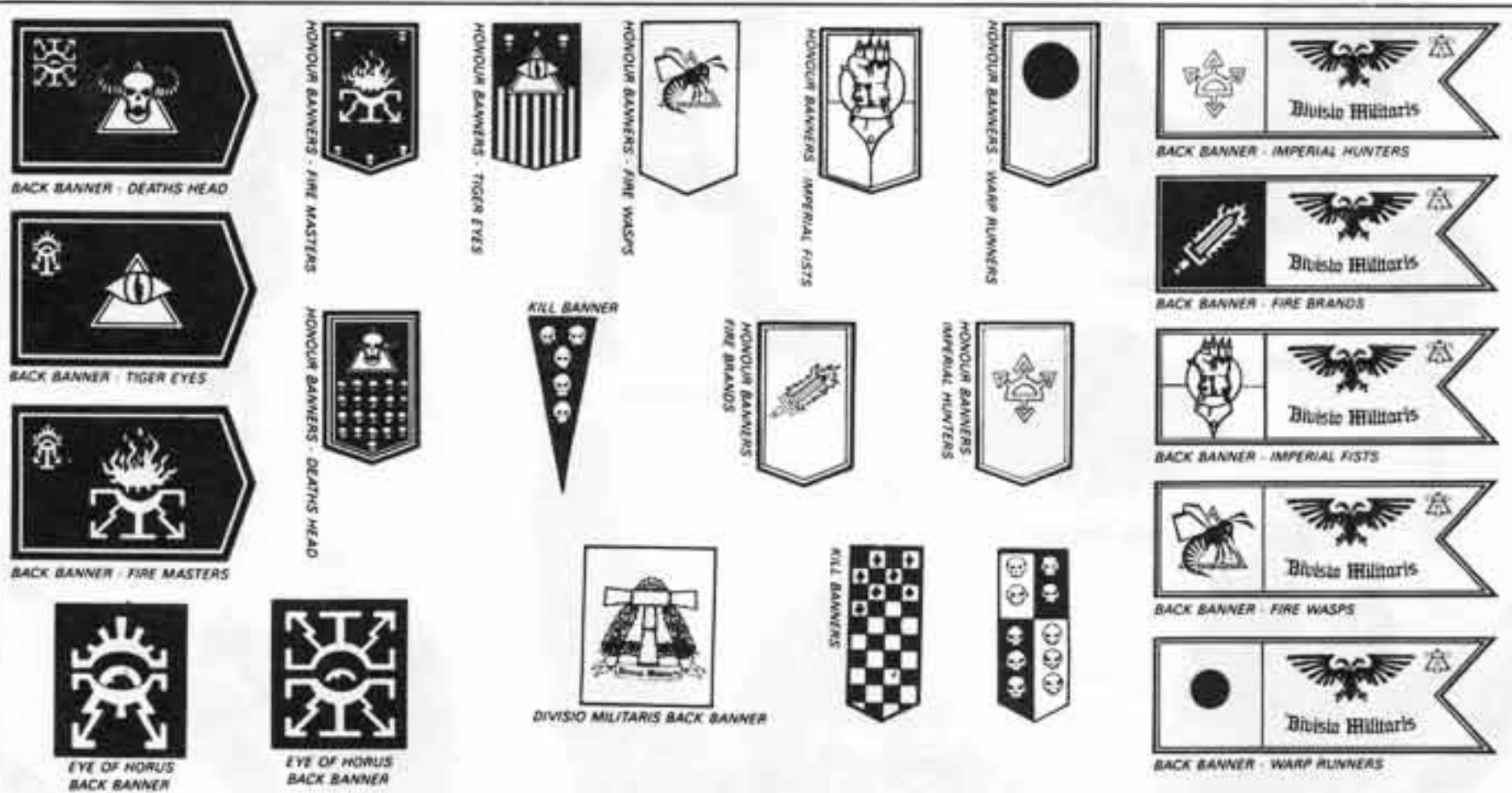

Titan and Goblin banners may be cut out and coloured using Citadel Colour paints and inks.

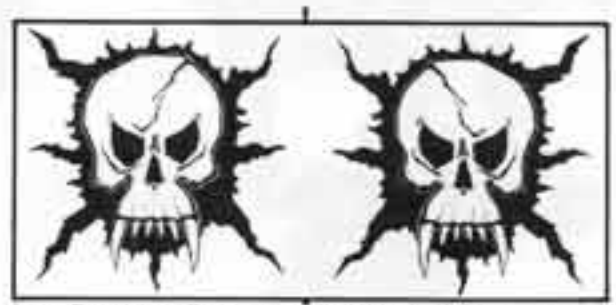

Bossflag (Chief's standard) of the Black Skull tribe.

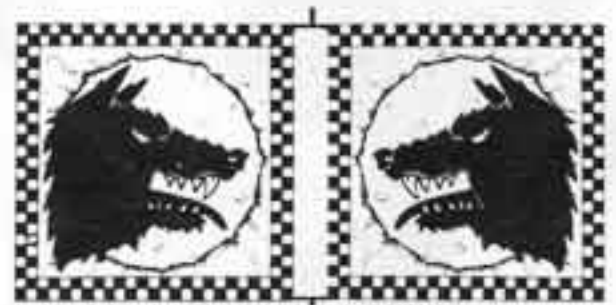

Standard of the Wolf's Head tribe.

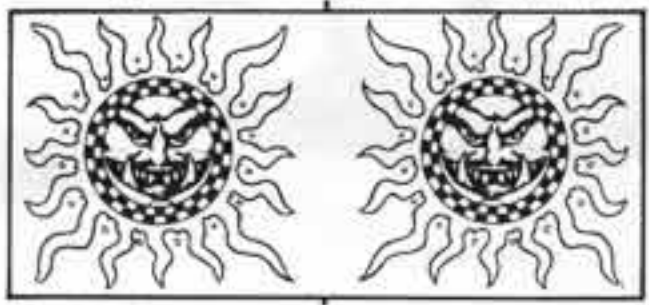

The Snarling Sun Standard



Standard of the Howling Moon tribe.



GOBLINS

WARRIORS

Designed by Kevin Adams



Figures supplied unpainted. **WARNING!** This product contains lead which may be harmful if chewed or swallowed. Citadel Miniatures are not recommended for children under 12 years of age.



Copyright © 1989 Games Workshop Ltd. All rights reserved.

GOBLINS

WARRIORS
 Designed by Kevin Adams
 20 H R M



070201

070202

070204

070206

070207

070203

070205

070208

070209

070211

070212

070210

070215

070216

070217

070213

070214

070220

070222

070223



070218



070219



070220



070221



070222



070223



070224



070225



070230



070226



070227



070228



070229



070233



070234



070231



070232



070235

Games Workshop Ltd. 1989. All rights reserved. Citadel Miniatures are not recommended for children under 12 years of age.



GOBLINS

WARRIORS

Designed by Kevin Adams



070301



070302



070303



070304



070305



070306



070307



070311



070308



070309



070310



FANATIC
070313



FANATIC
070316



FANATIC
070317



070312



FANATIC
070314



FANATIC
070315



FANATIC
070319



FANATIC
070318

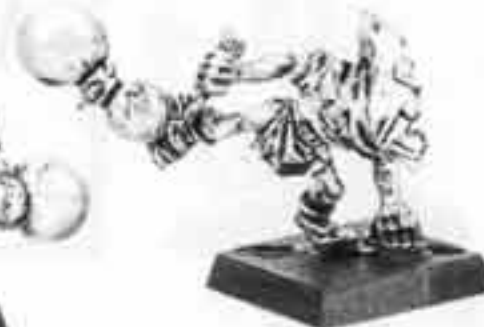

FANATIC
070320

GROM'S GOBLIN GUARD

Designed by Kevin Adams



MUSICIAN
070321



TROOPER
070322



LEADER
070323



CHAMPION
070324



STD. BEARER
070325

Figures supplied unpainted. WARNING! This product contains lead which may be harmful if chewed or swallowed. Citadel Miniatures are not recommended for children under 12 years of age.



TADPOLE
MINIATURES

Copyright © 1989 Games Workshop Ltd. All rights reserved.

GOBLINS

JAVELINMEN

Designed by Kevin Adams

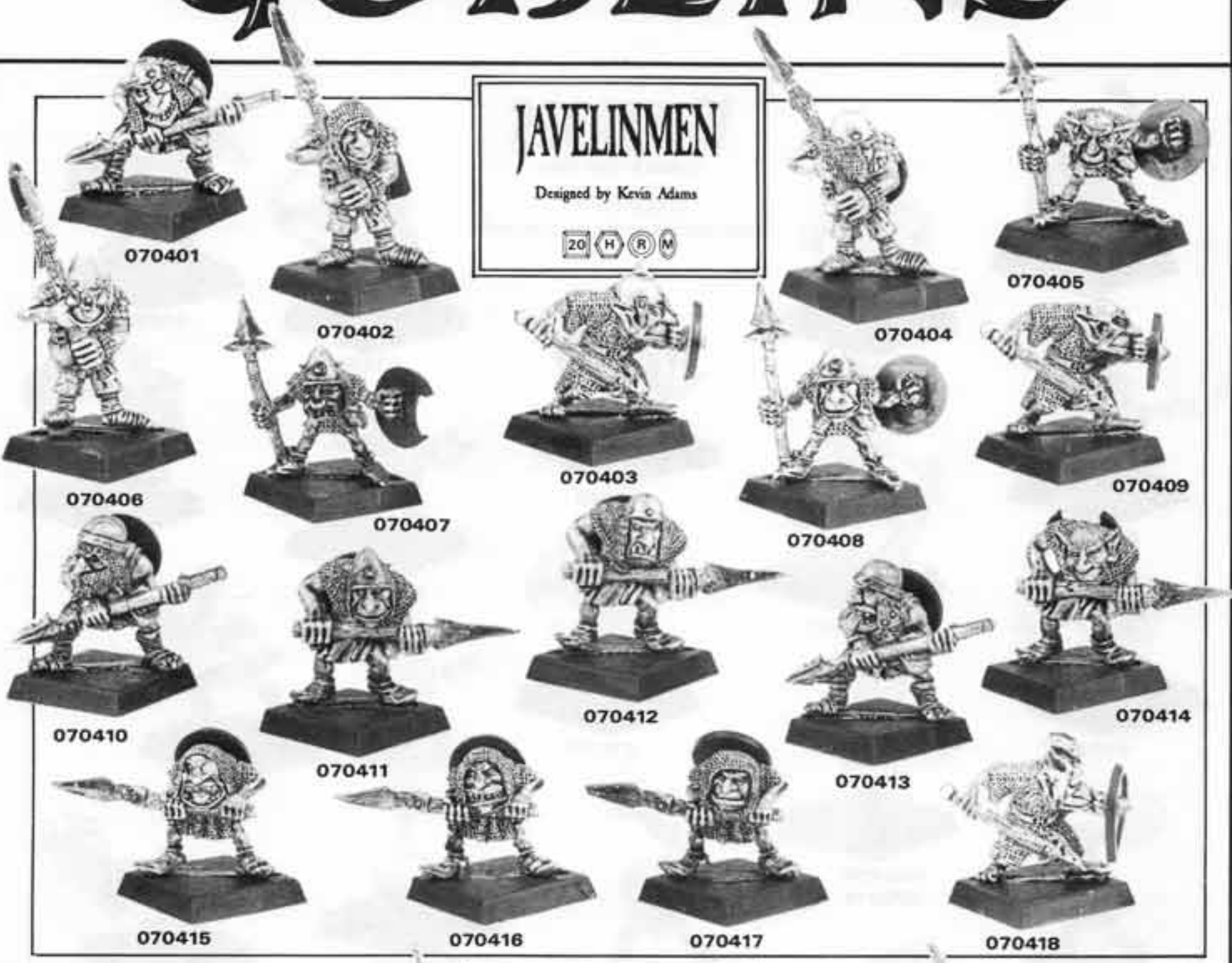

ARCHERS

Designed by Kevin Adams

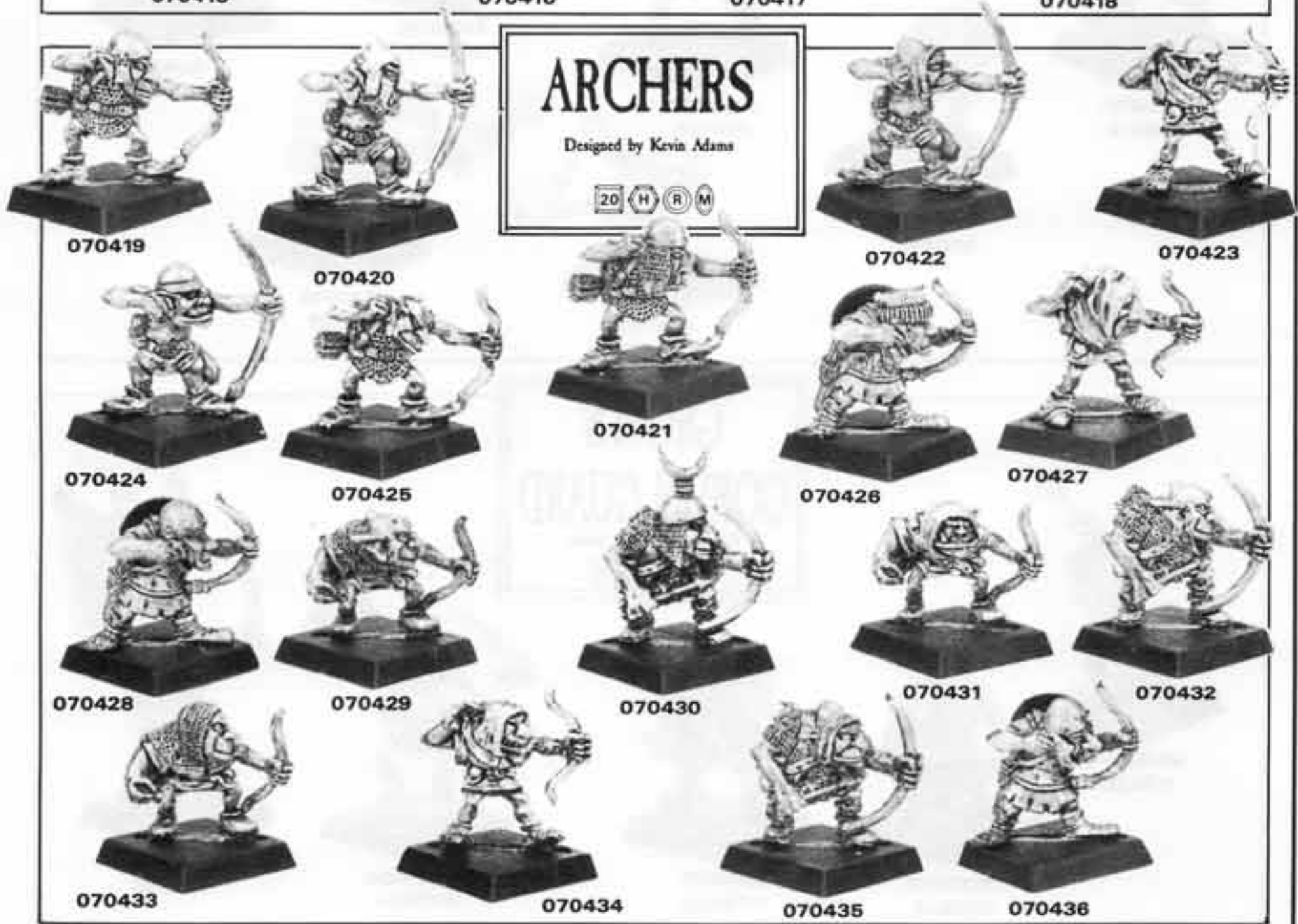

Copyright © 1989 Games Workshop Ltd. All rights reserved.

GOBLINS

SPEARMEN

Designed by Kevin Adams



070501

070502

070503

070504

070505

070506

070507

070508

070509

070510

070511

070512

070513

070514

070515

070516

070517

070518

COMMAND GROUP

Designed by Kevin Adams



CHAMPION
070519

SHAMAN
070520

CHAMPION 070523

STD. BEARER
070524



MUSICIAN
070525



SHAMAN
070526



SHAMAN
070521



STD. BEARER
070522



STD. BEARER
070528



LEADER
070529



MUSICIAN
070530



CHAMPION
070531



MUSICIAN
070527



CHAMPION
070532



LEADER
070533

Figures supplied unpainted. WARNING! This product contains lead which may be harmful if chewed or swallowed. Citadel Miniatures are not recommended for children under 12 years of age.



CITADEL MINIATURES

GOBLINS

WOLF RIDERS

Designed by Kevin Adams



070601



070602



070604



070605



070607



070603



070606



070608



070609



070610



070611



070613



070614



070612



070615



070616



070617



070618



070619

Copyright © 1989 Games Workshop Ltd. All rights reserved.

UNDEAD



CHAMPION
130101



CHAMPION
130102

**SKELETON
COMMAND
GROUP**
Designed by Aly Morrison & Bob
Naismith
25 20 H R M



CHAMPION
130103



MUSICIAN
130104



MUSICIAN
130105



LEADER
130106



STD BEARER
130107



STD BEARER
130108



MUSICIAN
130109



LEADER
130110



LEADER
130111



STD BEARER
130112



130113



130114

**SKELETON
INFANTRY**
Designed by Aly Morrison, Alan &
Michael Perry, Bob Naismith & Jes
Goodwin.
25 20 H R M



130115



130116



130117



130118



130119



130120



130121



130122

Figures supplied unpainted. WARNING! This product contains lead which may be harmful if chewed or swallowed. Citadel Miniatures are not recommended for children under 12 years of age.



CITADEL
MINIATURES

Copyright © 1989 Games Workshop Ltd. All rights reserved.

UNDEAD

SKELETON INFANTRY

Designed by Aly Morrison, Alan & Michael Perry, Bob Neismith & Jes Goodwin.



130201

130202

130203

130204

130205

CASUALTY
130206

130207

130208

130209

130210

130211

130212

130213

130214

130215

130216

130217

130218

130219

130220

130222

130223

130224

130225

130221

130227

130228

130229

130230

130231

CASUALTY 130232

130233

UNDEAD

SKELETON INFANTRY

Designed by Aly Morrison, Alan & Michael Perry, Bob Naismith & Jes Goodwin.

25 20 H R M



WARNING! This product contains lead which may be harmful if chewed or swallowed. Citadel Miniatures are not recommended for children under 12 years of age. Figures supplied unpainted.



CITADEL MINIATURES

Copyright © 1989 Games Workshop Ltd. All rights reserved.

UNDEAD

NIGHT HORRORS

Designed by Aly & Trish Morrison, Jes Goodwin, Alan & Michael Perry, Bob Naimith & Kevin Adams

25 20 H R M



130401



130402



130403



130404



130405



130406



130407



130410



130408



130409



130411



130412



130414



130413



130415



130416



130417



130418



130419



130420



130421



130422



130423



130424



130425



130426



130427



130428



130429



130430



130431



130432



130433



130434



130435

Copyright © 1989 Games Workshop Ltd. All rights reserved.

UNDEAD

NIGHT HORRORS

Designed by Aly & Trish Morrison, Jes Goodwin, Alan & Michael Perry, Bob Naismith & Kevin Adams



Figures supplied unpainted. **WARNING!** This product contains lead which may be harmful if chewed or swallowed. Citadel Miniatures are not recommended for children under 12 years of age.



Copyright © 1989 Games Workshop Ltd. All rights reserved.

UNDEAD

ZOMBIES

Designed by Kevin Adams.

25 20 H R M



130601



130602



130603



130604



130605



130606



130607



130612



130613



130608



130609



130610



130611



130614



130615



130616



130617



130618



130619



130620



130621



130622



130623



130624

UNDEAD

UNDEAD SAMURAI

Designed by Aly Morrison

25 20 H R M



130701



130702



130704

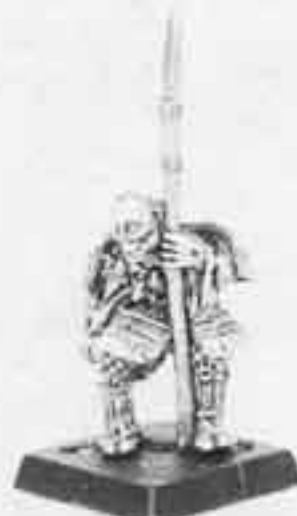

130708



130706



130707



130703



130705



130709



130714



130710



130711



130712



130713



130719



130715



130716



130717



130718



130720

NIGHTMARE LEGION

Designed by Michael & Alan Perry

25 20 H R M



LEADER
130721



CHAMPION
130722



TROOPER
130723



MUSICIAN
130724



TROOPER
130725



TROOPER
130726



TROOPER
130727



STD. BEARER
130728

Figures supplied unpainted. WARNING! This product contains lead which may be harmful if chewed or swallowed. Citadel Miniatures are not recommended for children under 12 years of age.



CITADEL
MINIATURES

Copyright © 1989 Games Workshop Ltd. All rights reserved.



BLOOD BOWL

SKAVEN

Designed by
Jes Goodwin



CATCHER
200511



LINEMAN
200513



THROWER
200505



LINEMAN
200512



KICKER
200502



BLITZER
200504



LINEMAN
200503



KICKER
200509



THROWER
200516



CATCHER
200508



LINEMAN
200508



LINEMAN
200501

LINEMAN
200514



LINEMAN
200507



LINEMAN
200510



BLITZER
200515

DWARF DEATH ROLLER

Designed by Mike Perry

200517



SNOTLINGS

Designed by Kevin Adams

40



SUPPLIED AS A RANDOM ASSORTMENT

HALFLINGS

Designed by Alan Perry



200518



200520



200521



200522



200523



200519

Figures supplied unpainted. WARNING! This product contains lead which may be harmful if chewed or swallowed. Citadel Miniatures are not recommended for children under 12 years of age.



BLOOD BOWL

STAR PLAYERS

Designed by Jes Goodwin,
Mark Copplestone, Kevin Adams
& Michael and Alan Perry



FRANK N STEIN



200601

WARDANCER



200602

CHAOS WARRIOR



200603

SKAVEN MUTANT



200604

CHAOS WARRIOR



200605

MUTANT BEASTMAN



200606

NINJA



200607

HALFLING



200608

WEREWOLF



200609

MUTANT



200610

DWARF WITH BAZUKA



200611

HUMAN



200612

SNOTLING



200613

DARK ELF



200614

MUTANT



200615

ORC CYBORG



200616

SNOTLINGS



200617



200618



200619



200620



200621



WARHAMMER™ 40K

MODELS REQUIRE ASSEMBLY

ALL MODELS ARE SUPPLIED WITH *BACK WEAPON MOUNT* AND ONE BACK WEAPON CHOSEN FROM: LAS-CANNON, MELTA-GUN OR HEAVY BOLTER. CRUSADER COMES COMPLETE WITH RIGHT AND LEFT POWER SWORDS. ALL OTHER ROBOTS HAVE A CHOICE OF TWO ARMS SELECTED FROM: AUTO-CANNON (FITS RIGHT OR LEFT), LEFT POWERGLOVE, RIGHT POWERGLOVE, LEFT FLAMER, RIGHT BOLTER, SIEGE HAMMER (FITS RIGHT OR LEFT)

IMPERIAL ROBOTS

Designed by
Bob Naismith

40

LEFT OR RIGHT HAND
AUTO CANNON
400912



LEFT HAND
POWERGLOVE
400913



CONQUEROR
400902

BACK WEAPON MOUNT
400906

LAS-CANNON
400909

RIGHT HAND POWERSWORD
400907

MELTA GUN
400910

HEAVY BOLTER
400911

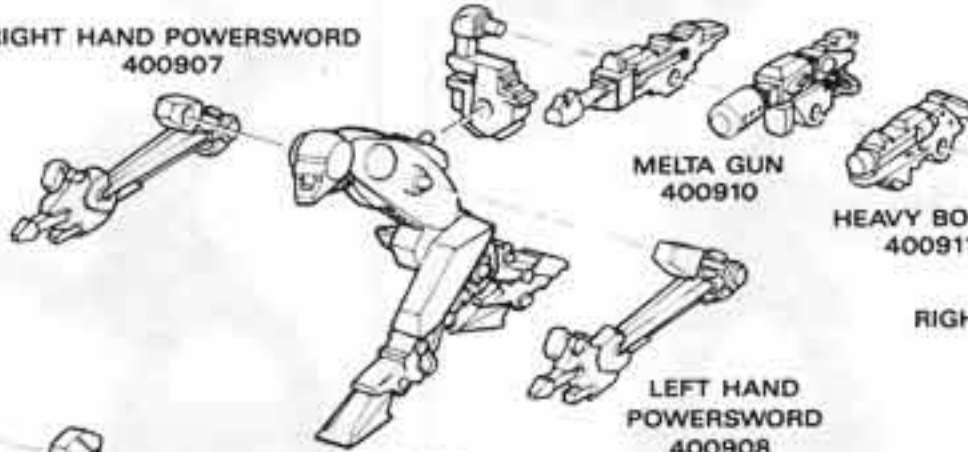

CRUSADER
400903

RIGHT HAND BOLTER
400916

LEFT OR RIGHT HAND
SIEGE HAMMER
400917



COLOSSUS
400901



CATAPHRACT
400905



LEFT HAND
FLAMER
400915

RIGHT HAND POWERGLOVE
400914



CASTELLAN
400904



CRUSADER



CATAPHRACT



CONQUEROR



COLOSSUS

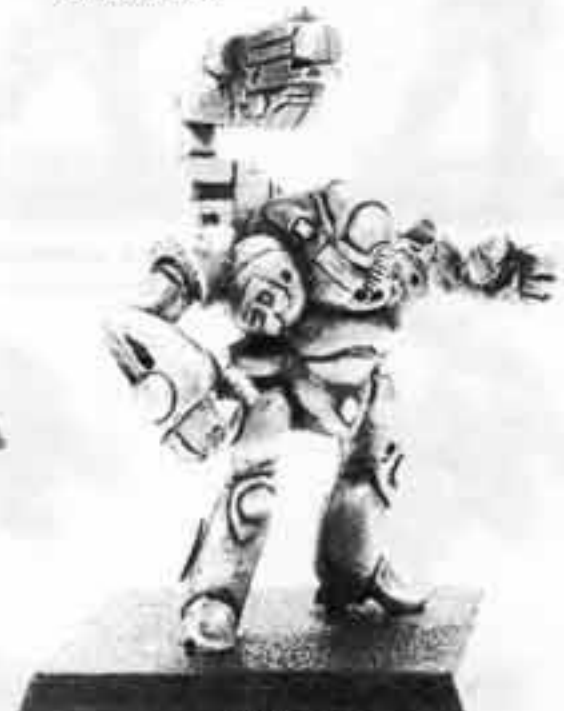

CASTELLAN

Figures supplied unpainted. WARNING! This product contains lead which may be harmful if chewed or swallowed. Citadel Miniatures are not recommended for children under 12 years of age.



WARHAMMER™ 40K

IMPERIAL GUARD COMMISSARS

Designed by Mark Coplestone



401003



401004



401002



401001

IMPERIAL GUARD BEASTMEN

Designed by Jes Goodwin



401011



401012

IMPERIAL GUARD

Designed by Mark Coplestone



401010 GUARDSMAN



401015 HUMAN BOMB



401009 PENITENT



401007 CAPTAIN



LIEUTENANT
401014



401005 COMMANDER



401006 SERGEANT



401008 ORDERLY



401013 MEDIC



401016 GRENADE LAUNCHER

INCLUDES PLASTIC ARMS & WEAPON SPRUES

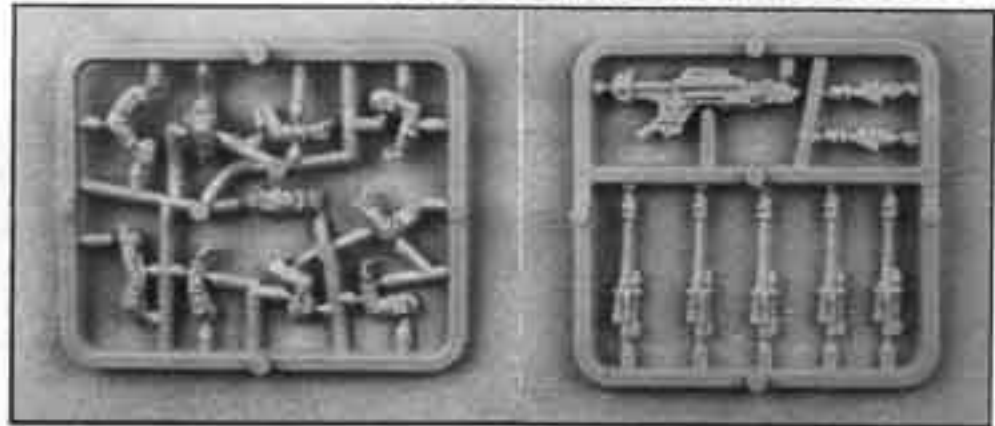

401009



401010



401005



401013

EXAMPLES OF THE ABOVE
MINIATURES WITH
PLASTIC ARMS



WARHAMMER™ 40K

ADEPTUS MECHANICUS

Designed by Bob Olley



401103 Adeptus



401104 Servitor



401107 Servitor



401102 Adeptus



401105 Servitor (Squat)



401106 Servitor



051301 Adeptus

WOUNDED IMPERIAL GUARD

Designed by Mark Coplestone

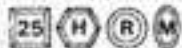

INCLUDES PLASTICS ARMS & WEAPON SPRUES



401111



401112



401113



401114

IMPERIAL GUARD RATLINGS

Designed by Alan Perry

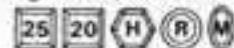

401108



401109



401110



EXAMPLES OF ABOVE MINIATURES WITH PLASTIC ARMS

Copyright © 1989 Games Workshop Ltd. All rights reserved.

Figures supplied unpainted. **WARNING!** This product contains lead which may be harmful if chewed or swallowed. Citadel Miniatures are not recommended for children under 12 years of age.



WARHAMMER™ 40K

IMPERIAL GUARD ROUGH RIDERS

Designed by
Mark Coplestone



401201 GUARDSMAN
401202 GUARDSMAN
401203 MEDIC

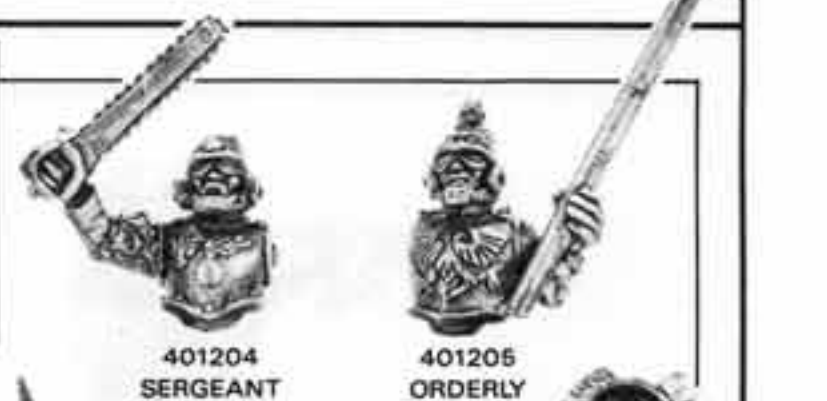

401204 SERGEANT
401205 ORDERLY



401207 COMMISSAR
401206 COMMISSAR



401208 COMMANDER
401209 CAPTAIN
401210 LIEUTENANT



401211 GRENADE LAUNCHER
401212 LEGS FOR USE WITH BIKES

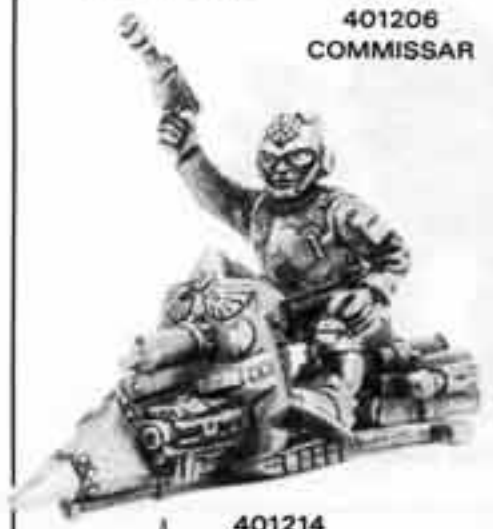

401214 JET BIKE



401215 MOTORBIKE



401216 EXAMPLE OF AN IMPERIAL GUARD ROUGH RIDER (SEE BELOW FOR ORDERING NUMBERS FOR HORSES)



401213 LEGS FOR USE WITH HORSE



401217 HORSE HEAD & TAIL A



401219 HORSE/RIGHT



401220 HORSE/RIGHT



401218 HORSE HEAD & TAIL B



401221 HORSE/LEFT



401222 HORSE/LEFT



000102

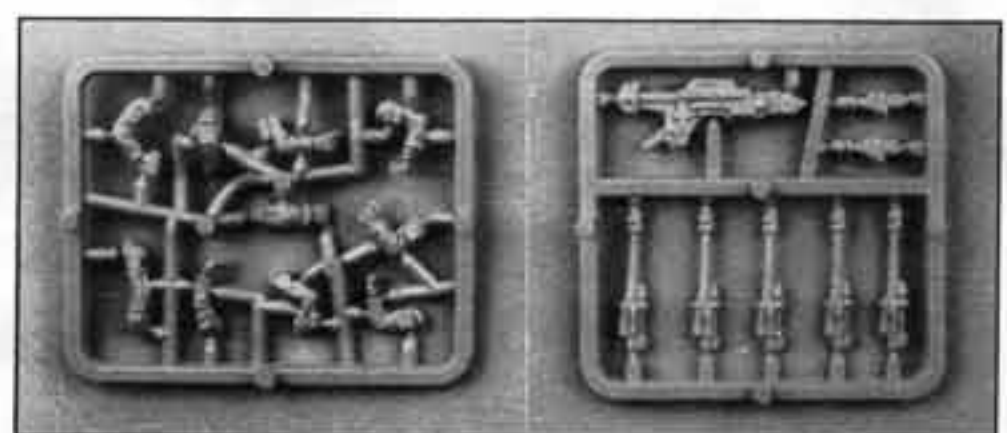

000803

000804

Figures supplied unpainted. **WARNING!** This product contains lead which may be harmful if chewed or swallowed. Citadel Miniatures are not recommended for children under 12 years of age.

SPACE MARINES

TECHMARINES

Designed by
Mark Coplestone

25 H R M



410501

410504

410505

410506

410503

410502

TECHMARINES

Designed by Mark
Coplestone & Alan Perry



410508
TECHMARINE
ON MOTORBIKE



410507
TECHMARINE
ON JET-BIKE

TERMINATOR SQUAD

DESIGNED BY JES GOODWIN

25 H R M

MODELS REQUIRE ASSEMBLY



TROOPER
410509



TROOPER
410510



EXAMPLE OF
TROOPER WITH BOLTER
& CHAINFIST



TROOPER
410511



LIBRARIAN
410512



CAPTAIN
410513



SERGEANTS
POWERSWORD
410514



BOLTER
(STANDARD)
410515



HEAVY FLAMER
410516



LIBRARIANS
POWERAXE
410520



CAPTAINS
POWERFIST
410523



CHAINFIST
410517



R-CANNON
410518



POWERGLOVE
(STANDARD)
410519



SHIELD
410521



SHIELD
410522



BOLTER
(PERSONALITY)
410524

Figures supplied unpainted. WARNING! This product contains lead which may be harmful if chewed or swallowed. Citadel Miniatures are not recommended for children under 12 years of age.



SPACE MARINES

CHAPLAINS

Designed by
Mark Copplestone

25 H R M



410603



410602



410606



410605



410604



410601

CHAPLAINS

Designed by Mark
Copplestone & Alan Perry

CHAPLAIN ON
MOTORBIKE
410607

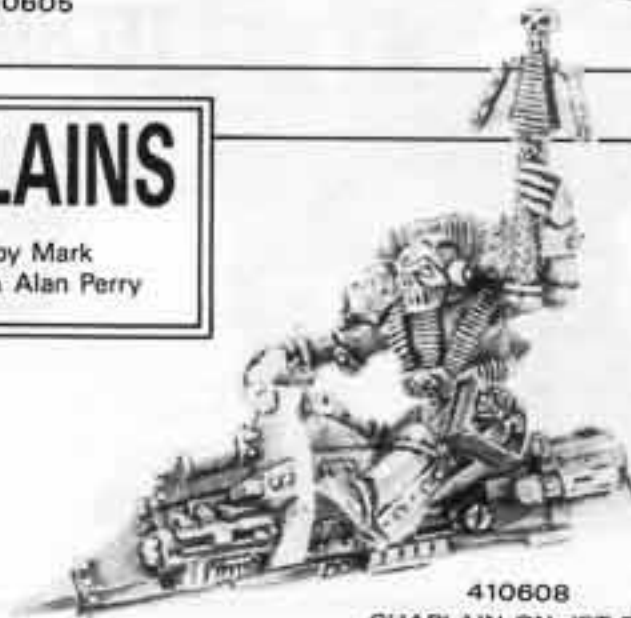

410608
CHAPLAIN ON JET BIKE

TERMINATOR MARINES

DESIGNED BY JES GOODWIN
& BOB NAISMITH

25 H R M



410611

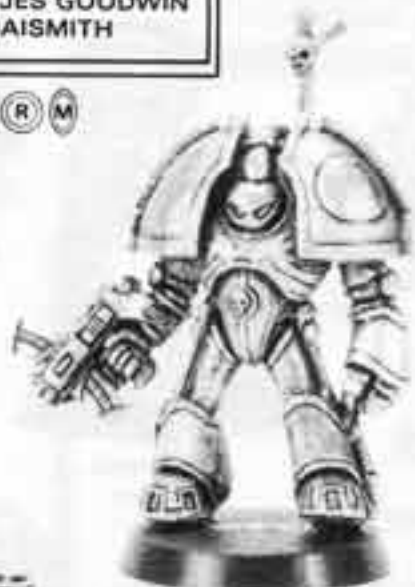

410609



410610

DEATH EAGLES

Designed by Mark Copplestone

25 H R M



410614



410612



410613

SQUATS

COMMAND GROUP

Designed by
Michael & Alan Perry

25 H R M



OFFICER
420101



OFFICER
420102



OFFICER
420103



CHAMPION
420104



CHAMPION
420105



CHAMPION
420106



MUSICIAN
420107



MUSICIAN
420108



MUSICIAN
420109



STD. BEARER
420110



STD. BEARER
420111



STD. BEARER
420112

WARRIORS

DESIGNED BY
MICHAEL & ALAN PERRY

25 H R M



420113



420114



420116



420117



420118



420119



CASUALTY
420115



420120



420121



420122



420123



420124



420125



420126



420127



420128



420129



420130



420131



420132

Figures supplied unpainted. WARNING! This product contains lead which may be harmful if chewed or swallowed. Citadel Miniatures are not recommended for children under 12 years of age.

SQUATS

WARRIORS

Designed by
Bob Olley



420201

420202

420204

420205

420206

420207

420208

CASUALTY
420203

420211

420210

420213

420209

420216

420212

420214

420219

420221

420218

420215

420222

420217

420224

420223

420220

420225

420226

420227

420228

This product contains lead which may be harmful if swallowed. Lead miniatures are not recommended for children under 12 years of age.

SQUATS

BIKERS

Designed by
Michael & Alan Perry

SUPPLIED WITH PLASTIC ARM & WEAPON SPRUES

SMALL
WHEEL
(TRIKE)
420305

LARGE
WHEEL
(TRIKE)
420306

HEADLAMP
420308

LARGE
WHEEL
(BIKE)
420307

420309
HEADLAMP
WITH
BOLTERS

BODY
420311

FRONT
420310



BIKER
420312



BIKER
420313



GUILDMASTER
420318



WARLORD
420314



HEARTHGUARD
420317



SQUAT RIDER
420301



SQUAT RIDER
420302

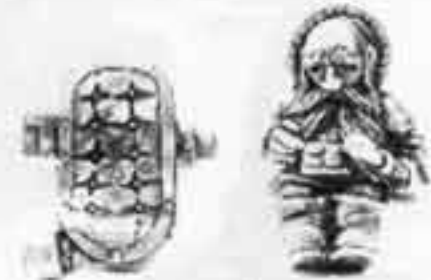

SIDECAR AND
LIVING ANCESTOR
PASSENGER
420316



SQUAT RIDER
420304

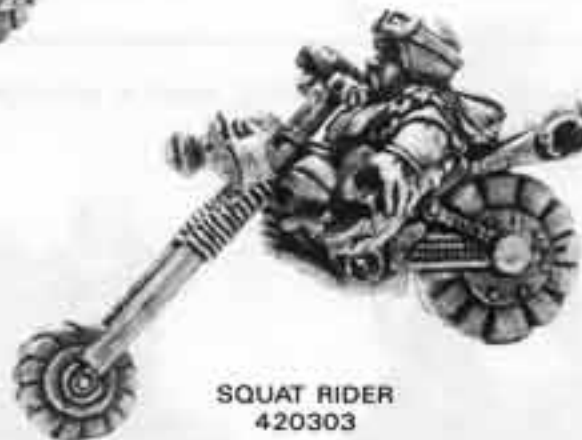

SQUAT RIDER
420303



BIKE & SIDECAR

EXAMPLES OF BIKE CONFIGURATIONS

HEAVY WEAPONS TRIKE

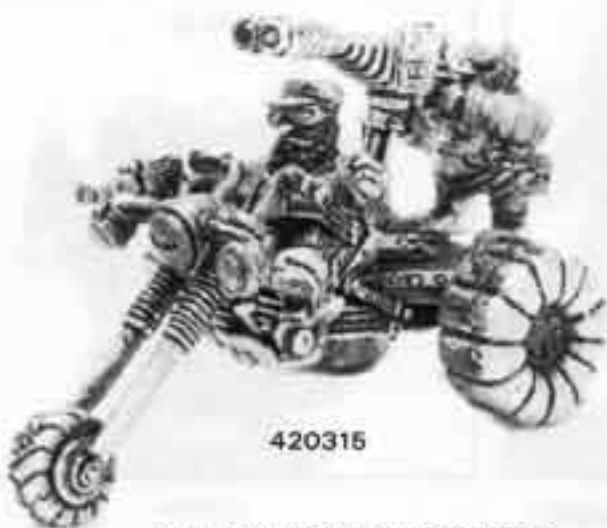

420315

SEE PAGE 4204 FOR GUNNERS



MOTORBIKE



SMALL
WHEELED TRIKE

Figures supplied unpainted. WARNING! This product contains lead which may be harmful if chewed or swallowed. Citadel Miniatures are not recommended for children under 12 years of age.



SQUATS

SQUATS

DESIGNED BY
MICHAEL & ALAN PERRY



BIKER
420403



BIKER
420404



WARRIOR
420409



WARRIOR
420410



BIKER
420405



BIKER
420406



GUILDMASTER
420401



CASUALTY
420408



WARRIOR
420407



HEARTHGUARD
420413



GUILDMASTER
420402



LIVING ANCESTOR
420411



HEARTHGUARD
420414



HEARTHGUARD
420415



WARLORD
420417



LIVING ANCESTOR
420412



HEARTHGUARD
420416

EXAMPLES OF THE ABOVE MINIATURES USING PLASTIC ARMS & WEAPONS



ALL OF THE ABOVE MINIATURES CAN BE USED AS GUNNERS WITH THE HEAVY WEAPON TRIKE (EXCEPT CASUALTY 420408)



ADEPTUS MECHANICUS SQUAT TECH PRIEST

420418



SQUAT EXO-ARMOUR

420419



Copyright © 1989 Games Workshop Ltd. All rights reserved.

ELDAR

HARLEQUINS

DESIGNED BY
JES GOODWIN



430501



HIGH WARLOCK
430505



430502



AVATAR
430503



430517



DEATH JESTER
430507



430511



DEATH
JESTER
430518



WARLOCK
430514



WARLOCK
430506



430512



DEATH JESTER
430516



AVATAR
430510



430513



430509



HIGH AVATAR
430504



430515



SOLITAIRE
430508

Figures supplied unpainted. WARNING! This product contains lead which may be harmful if chewed or swallowed. Citadel Miniatures are not recommended for children under 12 years of age.



ELDAR

HARLEQUINS

DESIGNED BY
JES GOODWIN

25 20 H R M



430604



430613



430608



430603



430601



430607



430611



430615



430612



430602



430606



430610



430605



430614



430609

JET BIKES

DESIGNED BY
JES GOODWIN



HARLEQUIN

430616

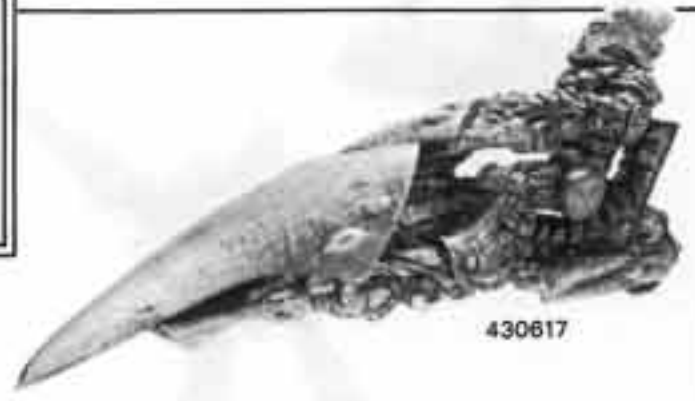

430617

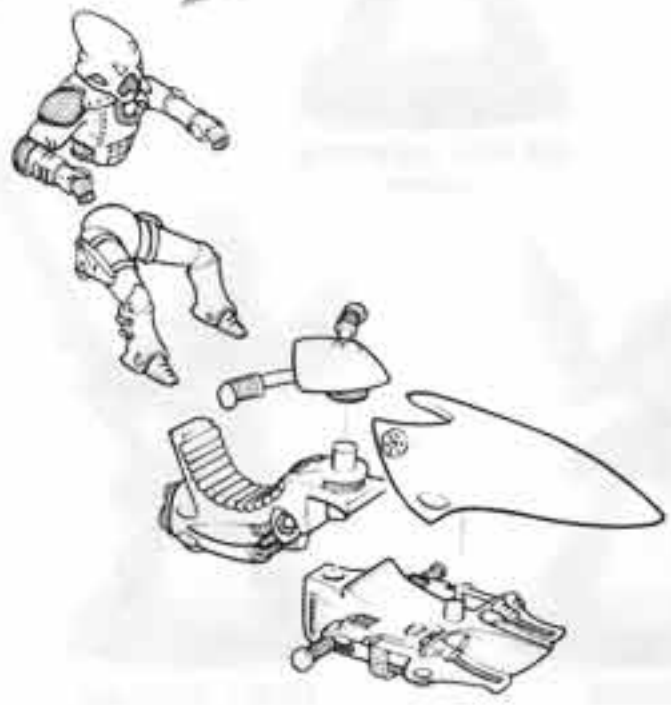
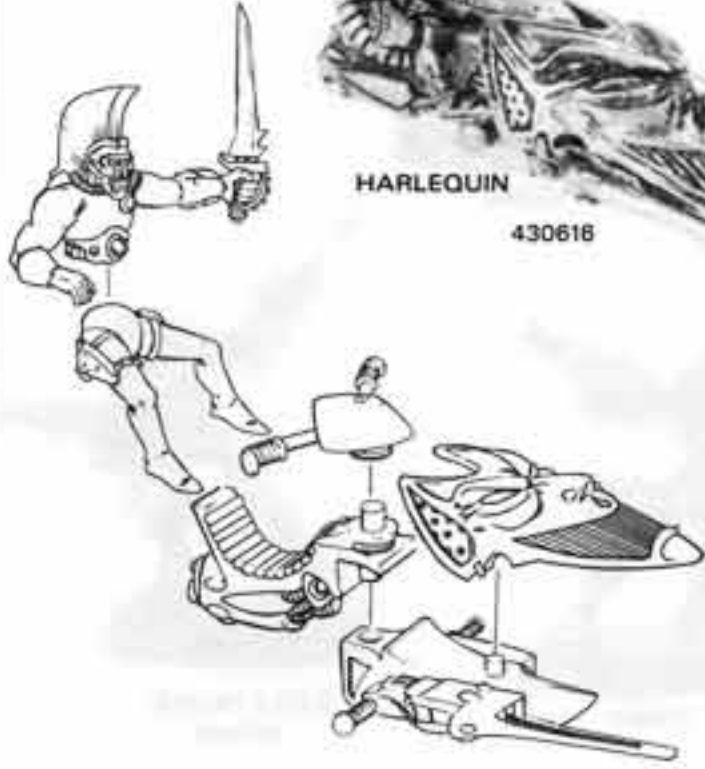

ADEPTUS TITANICUS

TITANS

Figures by Jes Goodwin

REAVER CLASS BATTLE TITANS

(1 legs, 2 feet, 1 body, 2 shoulders, 1 head, 3 weapons or 2 weapons & 1 spire)

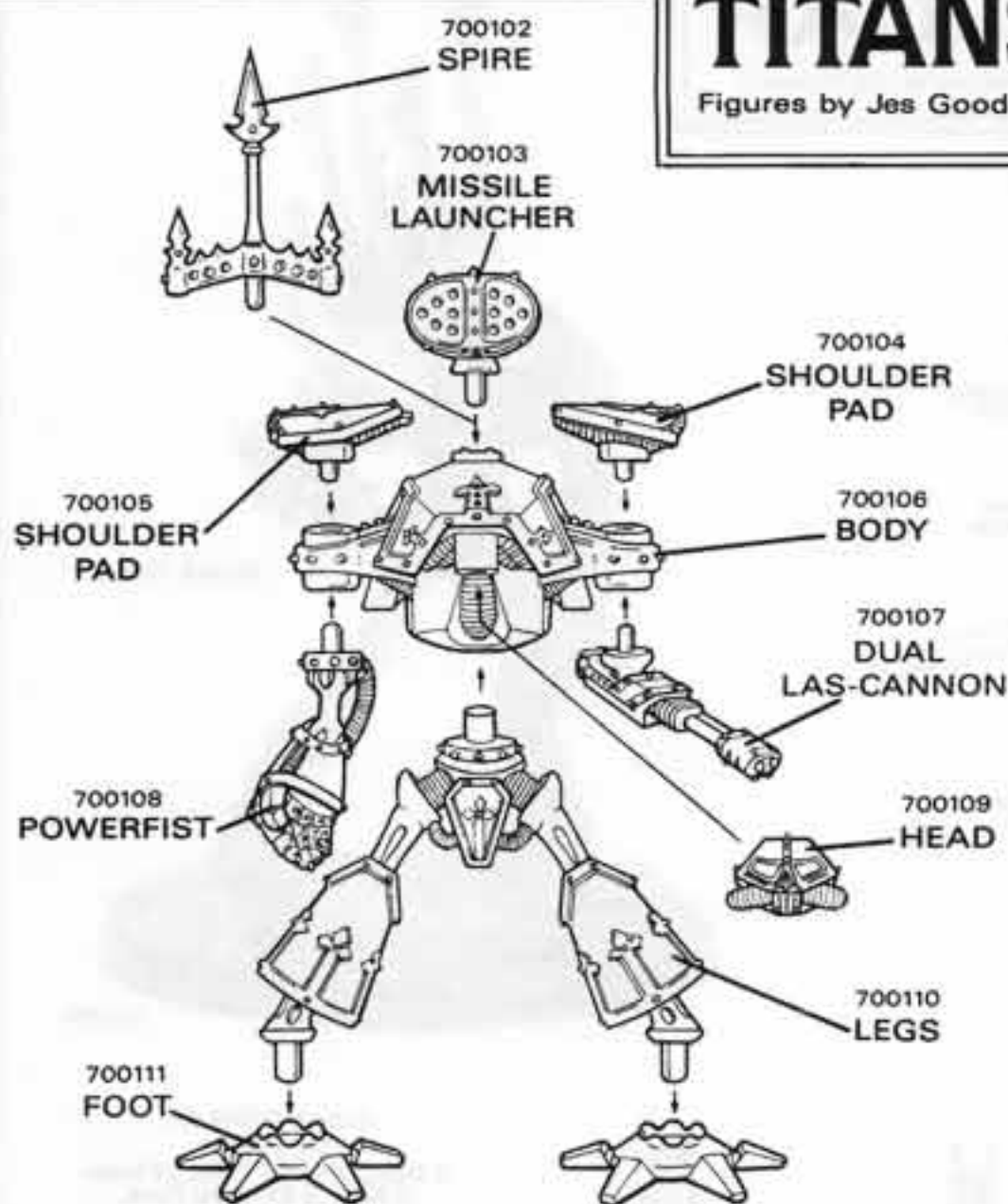

CHAINFIST AND POWERFIST FOR USE ONLY WITH REAVER CLASS BATTLE TITAN. ALL OTHER WEAPONS INTERCHANGEABLE.



700111 CHAINFIST



700112 HEAD



700107 DUAL LAS-CANNON



700113 MULTI-MELTA



700114 PLASMA GUN

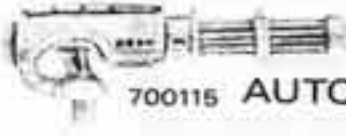

700115 AUTO CANNON

NOTE: MOST WEAPONS FROM THE PLASTIC WARLORD TITANS KIT ARE COMPATIBLE WITH BOTH REAVER AND WARHOUND TITANS.



40

WARHOUND CLASS SCOUT TITAN

(includes 1 body, 1 set of legs, coupling ring and choice of 2 weapons)

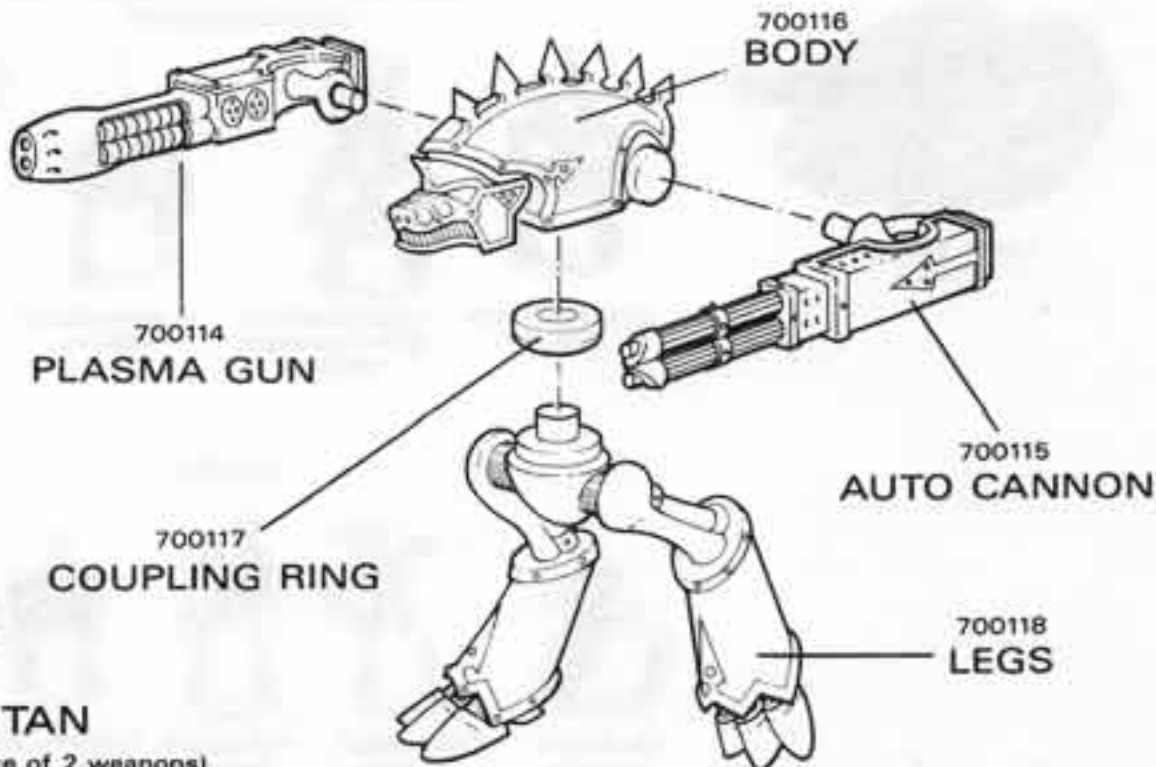

Figures supplied unpainted. WARNING! This product contains lead which may be harmful if chewed or swallowed. Citadel Miniatures are not recommended for children under 12 years of age.



ITADEL MINIATURES

ADEPTUS TITANICUS

ELDAR

Designed by Jes Goodwin

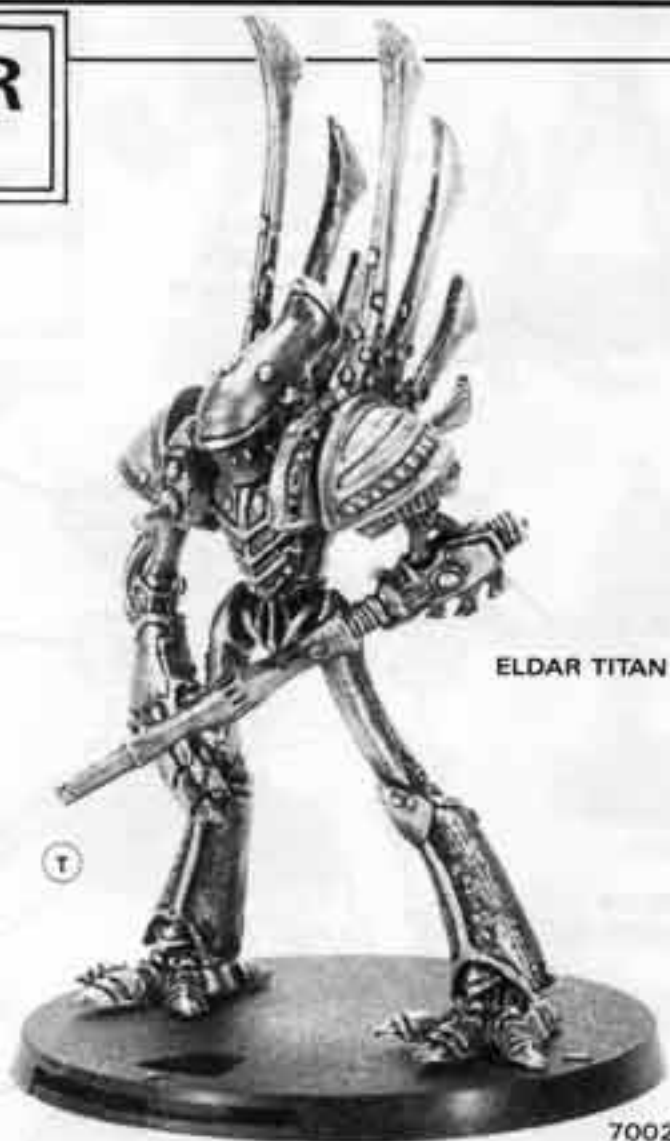
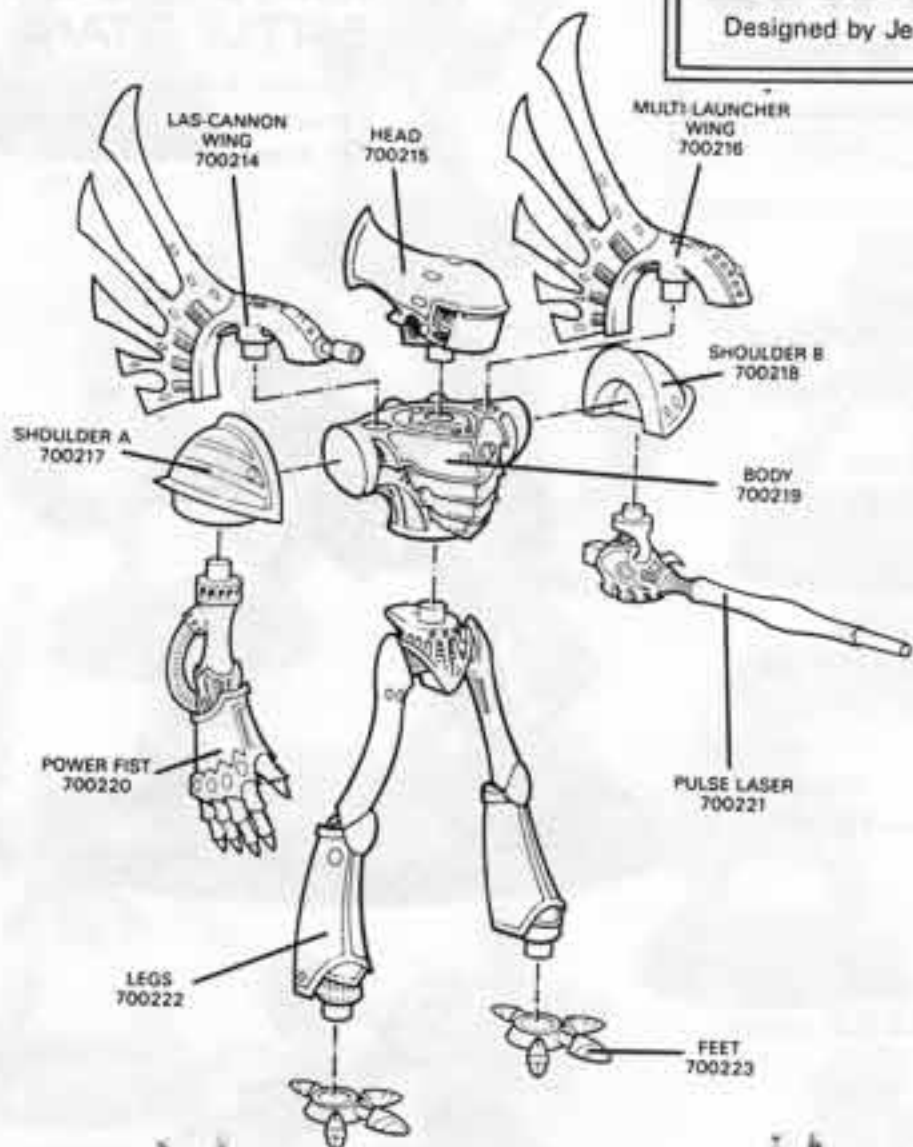

ELDAR TITAN KIT CONTAINS:

1 Head, 1 Body, 1 Set of Legs,
2 Feet, 2 Shoulder Pads,
2 Wings, 2 Weapons
(1 Power Fist & 1 Pulse Laser,
or 2 Pulse Lasers)

20
H
R
M



VAMPIRE SPIRIT WARRIOR
700202



WAR-WALKER
700204



WAR CRY DREADNOUGHT
700205



BANSHEE DREADNOUGHT
700203



FIELD ARTILLERY
700206

IMPERIAL

Designed by Bob Naismith,
Mark Coplestone
and Alan Perry

DREADNOUGHTS



LAND RAIDER
700208



CONTEMPTOR
700211



CONTEMPTOR WITH BANNER
700210



FURIBUNDUS
700212



DEREDEO
700213



RHINO
700209



MOTORBIKE
700219

ROBOTS



CRUSADER
700214



CONQUEROR
700215



COLOSSUS
700216



CATAPHRACT
700217



CASTELLAN
700218

All figures shown actual size. Copyright © 1989 Games Workshop Ltd. All rights reserved.